

HEYFORD PARK, BICESTER, PARCEL 6

LANDSCAPE AND ECOLOGICAL MANAGEMENT PLAN

DRAWINGS

October 2018

1619 A2 01 Rev L Detailed Planting Proposals

1619 A2 02 Rev M Detailed Planting Proposals

1619 A2 03 Parcel 6 Tree Planting Details

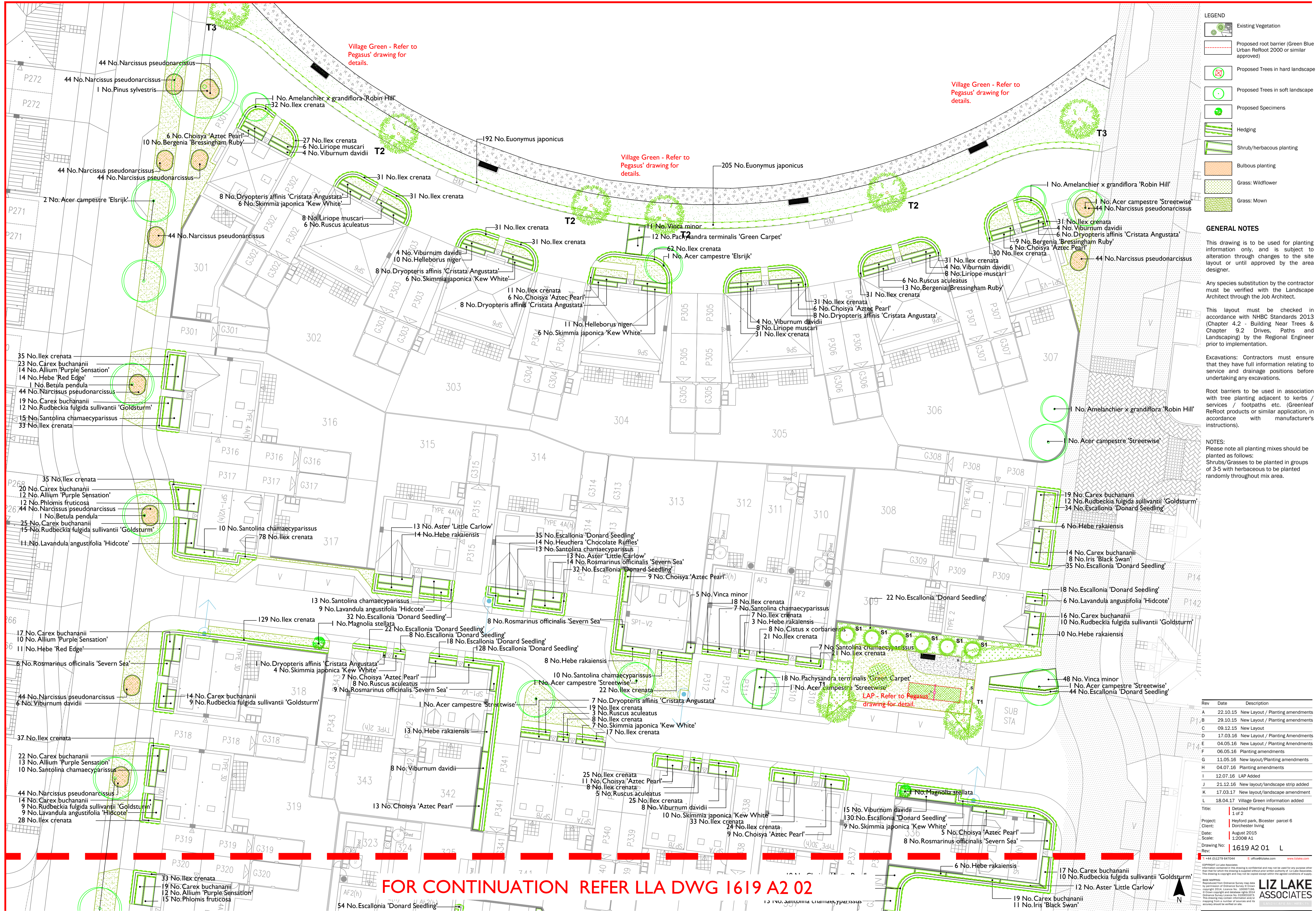

- LEGEND**
- Existing Vegetation
 - Proposed root barrier (Green Blue Urban ReRoot 2000 or similar approved)
 - Proposed Trees in hard landscape
 - Proposed Trees in soft landscape
 - Proposed Specimens
 - Hedging
 - Shrub/herbaceous planting
 - Bulbous planting
 - Grass: Wildflower
 - Grass: Mown

- GENERAL NOTES**
- This drawing is to be used for planting information only, and is subject to alteration through changes to the site layout or until approved by the area designer.
- Any species substitution by the contractor must be verified with the Landscape Architect through the Job Architect.
- This layout must be checked in accordance with NHBC Standards 2013 (Chapter 4.2 - Building Near Trees & Chapter 9.2 Drives, Paths and Landscaping) by the Regional Engineer prior to implementation.
- Excavations: Contractors must ensure that they have full information relating to service and drainage positions before undertaking any excavations.
- Root barriers to be used in association with tree planting adjacent to kerbs / services / footpaths etc. (Greenleaf ReRoot products or similar application, in accordance with manufacturer's instructions).

NOTES:
Please note all planting mixes should be planted as follows:
Shrubs/Grasses to be planted in groups of 3-5 with herbaceous to be planted randomly throughout mix area.

Rev	Date	Description
A	22.10.15	New Layout / Planting amendments
B	29.10.15	New Layout / Planting amendments
C	09.12.15	New Layout
D	17.03.16	New Layout / Planting Amendments
E	04.05.16	New Layout / Planting Amendments
F	06.05.16	Planting amendments
G	11.05.16	New layout/Planting amendments
H	04.07.16	Planting amendments
I	12.07.16	LAP Added
J	21.12.16	New layout/landscape strip added
K	17.03.17	New layout/landscape amendment
L	18.04.17	Village Green information added

Title: Detailed Planting Proposals
1 of 2
Project: Heyford park, Bicester parcel 6
Client: Dorchester Living
Date: August 2015
Scale: 1:200@ A1
Drawing No: 1619 A2 01 L
Rev: 1
T: +44 (0)1295 647044 E: office@lize.com www.lize.com

COPYRIGHT © Liz Lake Associates
This plan is a confidential document and may not be used for any purpose other than that intended by the client. It is the property of Liz Lake Associates and its content is confidential. It is to be used only for the purposes specified in the contract. It is not to be copied, reproduced, or disseminated without the prior written consent of Liz Lake Associates. The drawing is copyright and may not be copied or used without the prior written consent of Liz Lake Associates.

LIZ LAKE ASSOCIATES
Landscape Architects

FOR CONTINUATION REFER LLA DWG 1619 A2 02

FOR CONTINUATION REFER LLA DWG 1619 A2 01

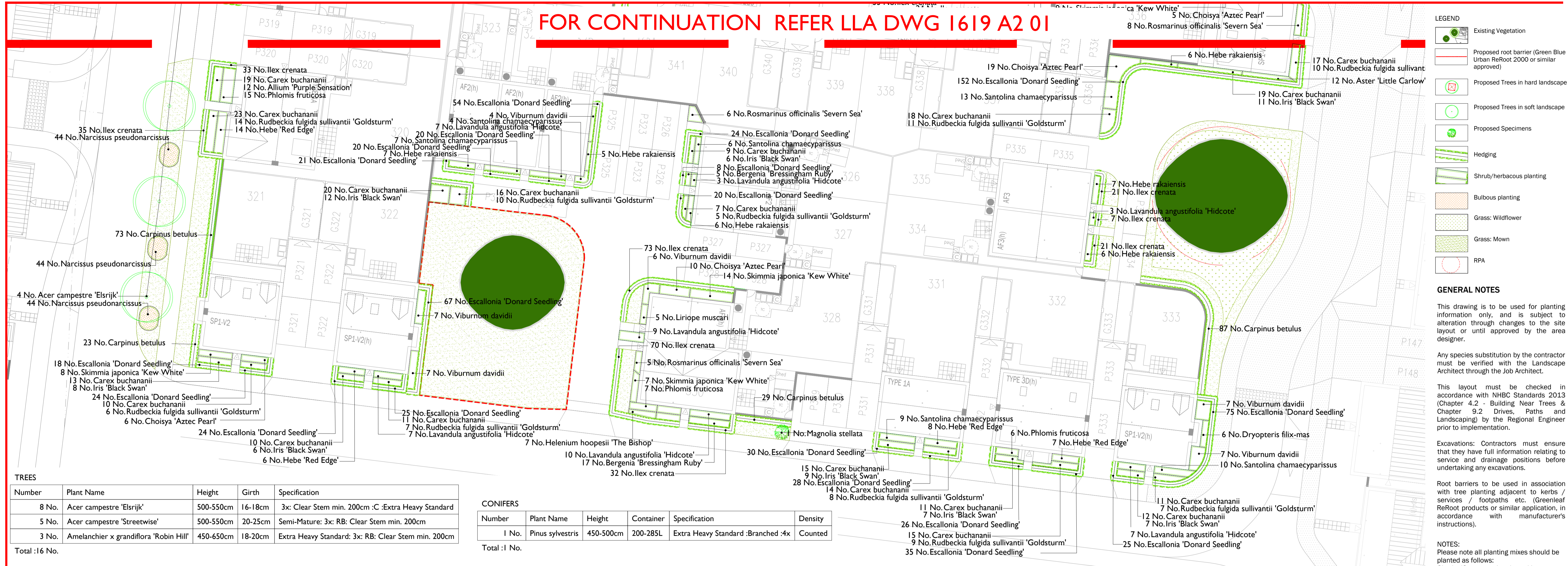

LEGEND

- Existing Vegetation
- Proposed root barrier (Green Blue Urban ReRoot 2000 or similar approved)
- Proposed Trees in hard landscape
- Proposed Trees in soft landscape
- Proposed Specimens
- Hedging
- Shrub/herbaceous planting
- Bulbous planting
- Grass: Wildflower
- Grass: Mown
- RPA

GENERAL NOTES

This drawing is to be used for planting information only, and is subject to alteration through changes to the site layout or until approved by the area designer.

Any species substitution by the contractor must be verified with the Landscape Architect through the Job Architect.

This layout must be checked in accordance with NHBC Standards 2013 (Chapter 4.2 - Building Near Trees & Chapter 9.2 - Drives, Paths and Landscaping) by the Regional Engineer prior to implementation.

Excavations: Contractors must ensure that they have full information relating to service and drainage positions before undertaking any excavations.

Root barriers to be used in association with tree planting adjacent to kerbs / services / footpaths etc. (Greenleaf ReRoot products or similar application, in accordance with manufacturer's instructions).

TREES

Number	Plant Name	Height	Girth	Specification
8 No.	Acer campestre 'Elsrijk'	500-550cm	16-18cm	3x: Clear Stem min. 200cm :C: Extra Heavy Standard
5 No.	Acer campestre 'Streetwise'	500-550cm	20-25cm	Semi-Mature: 3x: RB: Clear Stem min. 200cm
3 No.	Amelanchier x grandiflora 'Robin Hill'	450-650cm	18-20cm	Extra Heavy Standard: 3x: RB: Clear Stem min. 200cm

Total :16 No.

CONIFERS

Number	Plant Name	Height	Container	Specification	Density
1 No.	Pinus sylvestris	450-500cm	200-285L	Extra Heavy Standard :Branched :4x	Counted

Total :1 No.

HEDGING

Number	Plant Name	Height	Container	Specification	Density
212 No.	Carpinus betulus	100-125cm	5L	Branched: 5 brks: C	5/m
1254 No.	Escallonia 'Donard Seedling'	40-60cm	5L	Bushy: 5 brks: C	5/m
1356 No.	Ilex crenata	30-40cm	5L	Bushy: 8 brks: C	5/m

Total :2822 No.

BULBS

Number	Plant Name	Specification	Density
61 No.	Allium 'Purple Sensation'	Full Pot: C	3/m ²
616 No.	Narcissus pseudonarcissus	Grade 5/6	10/m ²

Total :677 No.

HERBACEOUS

Number	Plant Name	Container	Specification	Density
38 No.	Aster 'Little Carlow'	3L	Full Pot: C	4/m ²
54 No.	Bergenia 'Bressingham Ruby'	3L	Full Pot: C	5/m ²
7 No.	Helenium hoopesii 'The Bishop'	3L	Full Pot: C	4/m ²
21 No.	Helleborus niger	3L	Full Pot: C	4/m ²
14 No.	Heuchera 'Chocolate Ruffles'	3L	Full Pot: C	4/m ²
74 No.	Iris 'Black Swan'	3L	Full Pot: C	3/m ²
154 No.	Rudbeckia fulgida sullivantii 'Goldsturm'	3L	Full Pot: C	3/m ²

Total :362 No.

SHRUBS

Number	Plant Name	Height	Container	Specification	Density
113 No.	Choisya 'Aztec Pearl'	30-40cm	5L	Bushy: 6 brks: C	3/m ²
8 No.	Cistus x corbariensis	40-60cm	5-7.5L	Bushy: 6 brks: C	3/m ²
60 No.	Hebe 'Red Edge'	5-7.5L	5-7.5L	Bushy: 7 brks: C	3/m ²
91 No.	Hebe rakaiensis	5-7.5L	5-7.5L	Bushy: 7 brks: C	3/m ²
81 No.	Lavandula angustifolia 'Hidcote'	20-30cm	5L	Bushy: 7 brks: C	3/m ²
3 No.	Magnolia stellata	150-175cm	45L	Branched: 5 brks: C	Counted
40 No.	Pachysandra terminalis 'Green Carpet'	5L	Several Shoots: 11 brks: C	3/m ²	
30 No.	Phlomis fruticosa	30-40cm	5-7.5L	Branched: 5 brks: C	3/m ²
56 No.	Rosmarinus officinalis 'Severn Sea'	40-60cm	5L	Bushy: 5 brks: C	3/m ²
28 No.	Ruscus aculeatus	30-40cm	3L	Several Shoots: 3 brks: C	3/m ²
134 No.	Santolina chamaecyparissus	30-40cm	5L	Bushy: 8 brks: C	3/m ²
77 No.	Skimmia japonica 'Kew White'	30-40cm	5L	Bushy: 4 brks: C	3/m ²
95 No.	Viburnum davidii	30-40cm	5-7.5L	Bushy: 4 brks: C	2/m ²
64 No.	Vinca minor	5-7.5L	Several Shoots: 5 brks: C	3/m ²	

Total :880 No.

PLANTING

Plant Stock and Timing
Plant material and operations shall conform to BS8545 : 2014, BS 3936 Nursery Stock (Parts 1-10), BS 4428 : 1989, BS 4043 : 1989 and BS 5837 : 2012. The planting season shall be from the 1st October to the 31st March. Container grown stock may be planted outside this season if accompanied by daily watering, or as necessary to ensure healthy establishment. Planting shall not be carried out during periods of frost, drought, cold drying winds or when the soil is waterlogged or frozen.

Planting
All planting that is within the root protection area of existing trees/shrubs to be retained, shall be undertaken by hand and positions altered should tree roots be encountered, in order to avoid damage to the root system.

All plants shall be set out evenly over the areas as indicated, to the density and quantities shown. All plants shall be planted upright at the same depth as the nursery soil level and evenly spaced, leaving room for growth. All restrictive containers shall be removed with roots not twisted. Immediately following planting, all plants shall be watered-in to field capacity.

Container grown and root balled plants shall be planted in a planting pit sufficient to accommodate the plant without causing root damage, with a minimum 50mm backfill beyond the root ball extent. Plants to be firm, watered-in and dead, damaged or topped branches shall be removed after planting. Bare-root plants shall be silt planted, incorporating an approved high phosphate, slow-release fertiliser.

Tree Planting and Support
Trees planted in landscape areas shall be double staked and tied to timber crossbar positioned 25mm below the top of each stake, using 1no. biodegradable fixing with spacer. Tree stakes shall have a minimum top diameter of 75mm, with the length of stake maximum 500mm above ground and minimum 500mm below ground.

All trees to be firm in after planting. All trees shall have irrigation / aeration system units fitted to fully surround the root ball.

Hedge Planting
Hedges shall be planted in a double staggered row as per detail. Dead, damaged or straggly branches shall be removed after planting. All transplants in hedge and native mixes shall be fitted with individual protection like shrub shelters, spiral guards as specified, or alternatively the planting areas shall be protected with rabbit-proof fencing. All shrub shelters / spiral guards shall be black or green, adequately supported and installed to allow for expansion.

Bulb Planting
Bulbs shall be planted according to species and good horticultural practice. Swatches of bulbs shall be randomly planted avoiding straight lines and / or formal layout unless otherwise specified.

Mulching
Prior to the application of mulch the planting areas shall be completely weed free and watered sufficiently to achieve field capacity. The surface of the planting areas shall be mulched with a minimum 75mm depth layer of 15-65mm nominal particle size, dark, matured woodchip mulch, ensuring that the low branches of trees, shrubs and/or herbaceous plants are NOT smothered.

Mulch shall be an approved product and completely weed and weed seed free. The mulch shall be topped up to maintain, after settlement, a depth of not less than 50mm. Trees in grass areas shall be planted centrally within a 1m diameter mulch bed, to be mulched to 75mm deep. The surface of mulch to be 10mm below the surface of adjacent lawn / hard surface.

GRASS AREAS
Turf shall accord with BS 3969: 1998, it shall be good quality meadow / cultivated, amenity turf free from weeds and be laid on even, prepared ground (as detailed above), during periods of suitable warm and moist weather conditions. Pre-turfing fertiliser shall be applied to manufacturer's recommendations and turf shall be laid in accordance with BS 4428: 1989.

Turf shall be laid with broken joints well-butted up, working from timber planks to avoid damaging turf when laying. Water as necessary to avoid shrinkage and achieve satisfactory establishment. Undertake good horticultural practice to ensure establishment of a healthy grass sward.

Grass Seeding
Areas of amenity grass shall be seeded with a general amenity grass mix as specified during the period March to May or September to October, during periods of moist, warm weather conditions without significant wind. Pre-seeding fertiliser shall be applied to manufacturer's recommendations. Seed shall be sown on even, prepared ground (as detailed above), at a rate of 5g/m² or as specified. Lightly roll seed bed after sowing. Water as necessary to avoid shrinkage and achieve satisfactory establishment. Undertake good horticultural practice to ensure establishment of a healthy grass sward.

Wildflower Grassland Seeding
Areas of wildflower grassland shall be seeded with a wildflower grassland mix suitable for the soil type as specified, during the period March to May or September to October, during periods of suitable warm and moist weather conditions. Seed shall be sown on prepared ground (as detailed above), at a rate of 5g/m² or as specified. Lightly roll seed bed after sowing. Water as necessary to avoid shrinkage and achieve satisfactory establishment. Undertake good horticultural practice to ensure establishment of a healthy wildflower grass sward.

AFTERCARE PERIOD
Regular Visits
During the specified Aftercare Period maintenance visits shall be carried out, at least monthly from April to September and twice during the dormant season to carry out the following operations to establish healthy growing plants / grass in weed free areas: watering, firming-up, removal of litter, pest and disease control, general pruning, checking guards, ties and stakes, weed control, grass cutting and autumn tidying. All arisings shall be carted away and the site shall be left clean and tidy at all times.

Watering
All planting and grass areas shall not be allowed to dry out and shall be kept well watered during the growing season, ensuring the soil is kept moist at all times but avoiding waterlogging.

Replacement Planting
During each August within the Aftercare Period an inspection shall be made and any plants that have died, are missing, damaged or have failed to thrive, shall be noted and replaced in the following planting season.

Grass Cutting
During the first and subsequent growing seasons amenity grass shall be kept at a height of 25mm to 50mm. Any bare patches are to be resown. Selective weed control shall be undertaken as necessary once the sward is sufficiently established.

Wildflower Grassland Cutting
During the first growing season cut wildflower grassland every 2 months to a height of 50mm and in subsequent growing seasons cut to 50mm height during late March and late August / early September or as specified. All arisings shall be collected and removed from the site to avoid smothering the sward and to reduce nutrient levels. Spot treat perennial weeds with Glyphosate at the manufacturer's recommended dose rate / or hand pull.

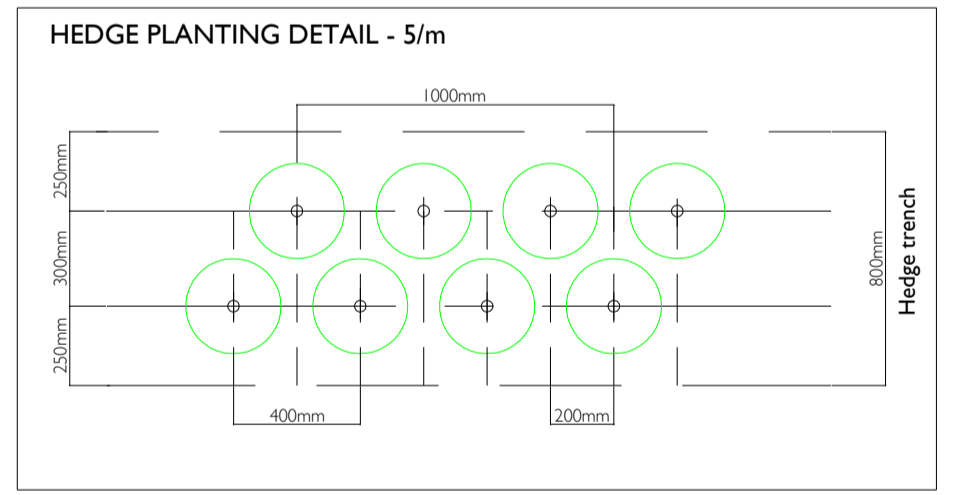

For tree planting details refer to drawing no. 1619 A2 03

Rev	Date	Description
A	22.10.15	New Layout / Planting amendments
B	29.10.15	New Layout / Planting amendments
C	08.12.15	New Layout / Planting amendments and tree moved adjacent to plot 325
D	17.03.16	New Layout / Planting amendments
E	04.05.16	New layout / Planting amendments
F	06.05.16	Planting amendments
G	11.05.16	New layout/Planting amendments
H	04.07.16	Planting amendments
I	12.07.16	LAP Removed
J	15.11.16	Tree specifications updated in relation to condition 6.
K	21.12.16	New layout/landscape strip added
L	17.03.17	New layout/landscape amendment
M	19.10.17	Tree details removed- refer to drawing 1619 A2 03

Title: Detailed Planting Proposals 2 of 2
 Project: Heyford park, Bloester, Parcel 6
 Client: Dorchester Living
 Date: August 2015
 Scale: 1:200@ A1
 Drawing No: 1619 A2 02 M
 Rev: M

T: +44 (0)1279 647044 E: office@lizlake.com www.lizlake.com

©2015 Liz Lake Associates
 Information contained in this drawing is confidential and may not be used for any purpose other than that for which it was prepared without the written authority of Liz Lake Associates.
 This drawing is copyright and may not be copied or used without the agreed conditions of sale.

Best Mapping
 Ordnance Survey
 Selective Weed Control
 Selective Weed Control
 Selective Weed Control
 Selective Weed Control
 Selective Weed Control

LIZ LAKE ASSOCIATES
 LANDSCAPE ARCHITECTS

TREE PLANTING IN HARD LANDSCAPE DETAIL: 1:40 GREEN-TECH ARBORRAFT SYSTEM

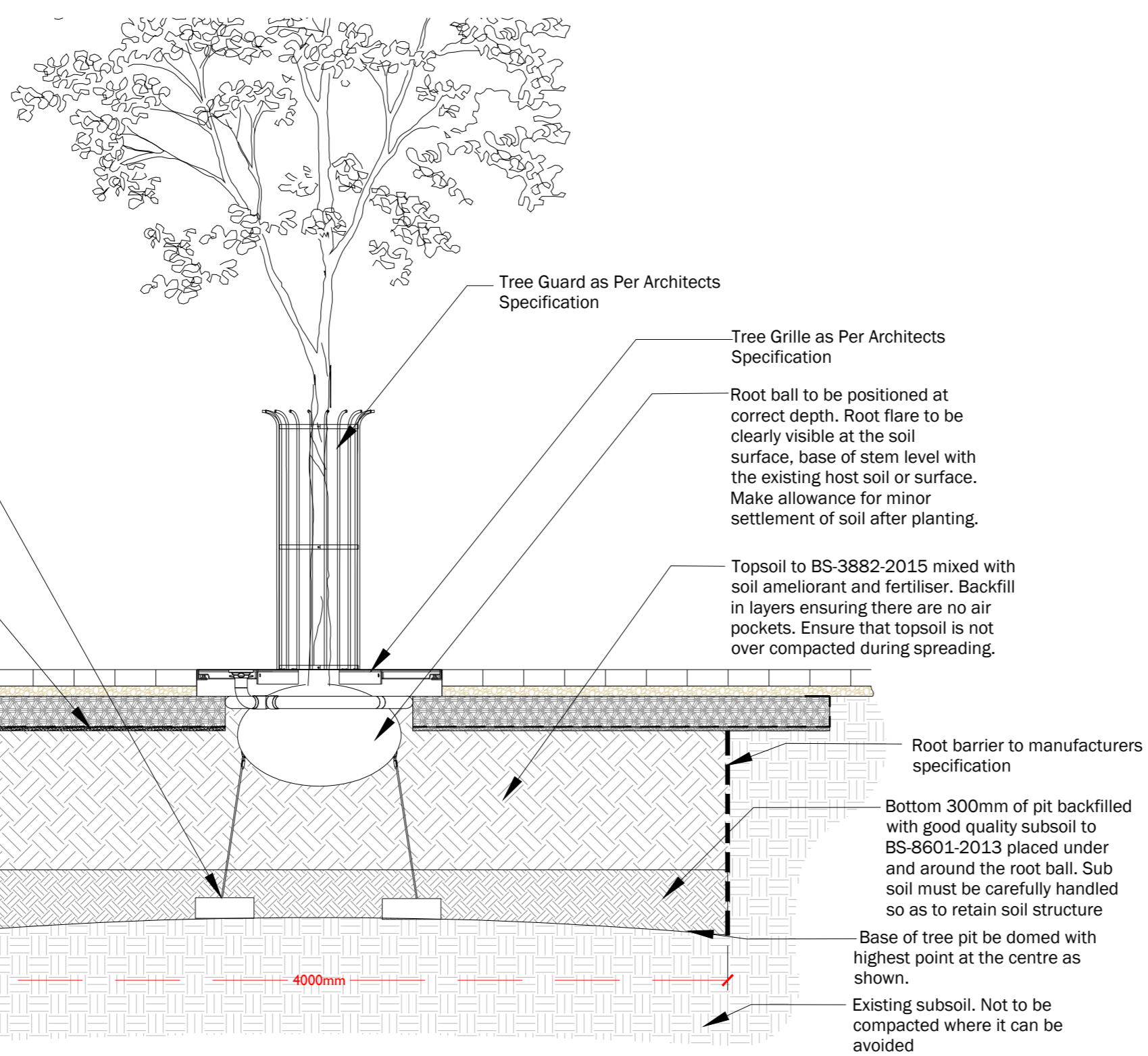

TREE PLANTING IN SOFT LANDSCAPE DETAIL: 1:40 UNDERGROUND GUYING SYSTEM

To be used in planting of trees with specified 18-20cm to 25-30 girth

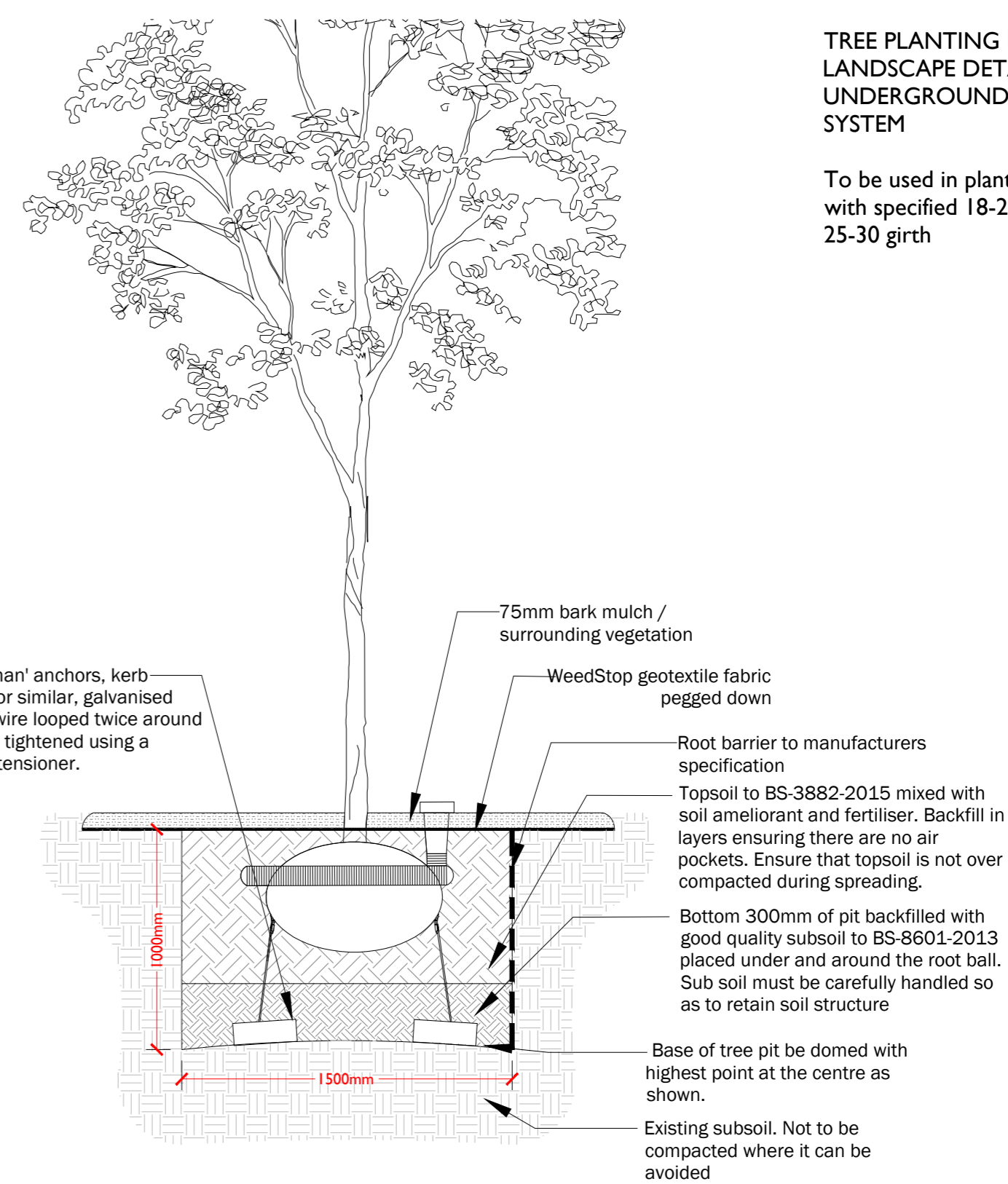

TREE PLANTING IN SMALL AREAS OF SOFT LANDSCAPE DETAIL: 1:40 GREEN-TECH ARBORRAFT SYSTEM

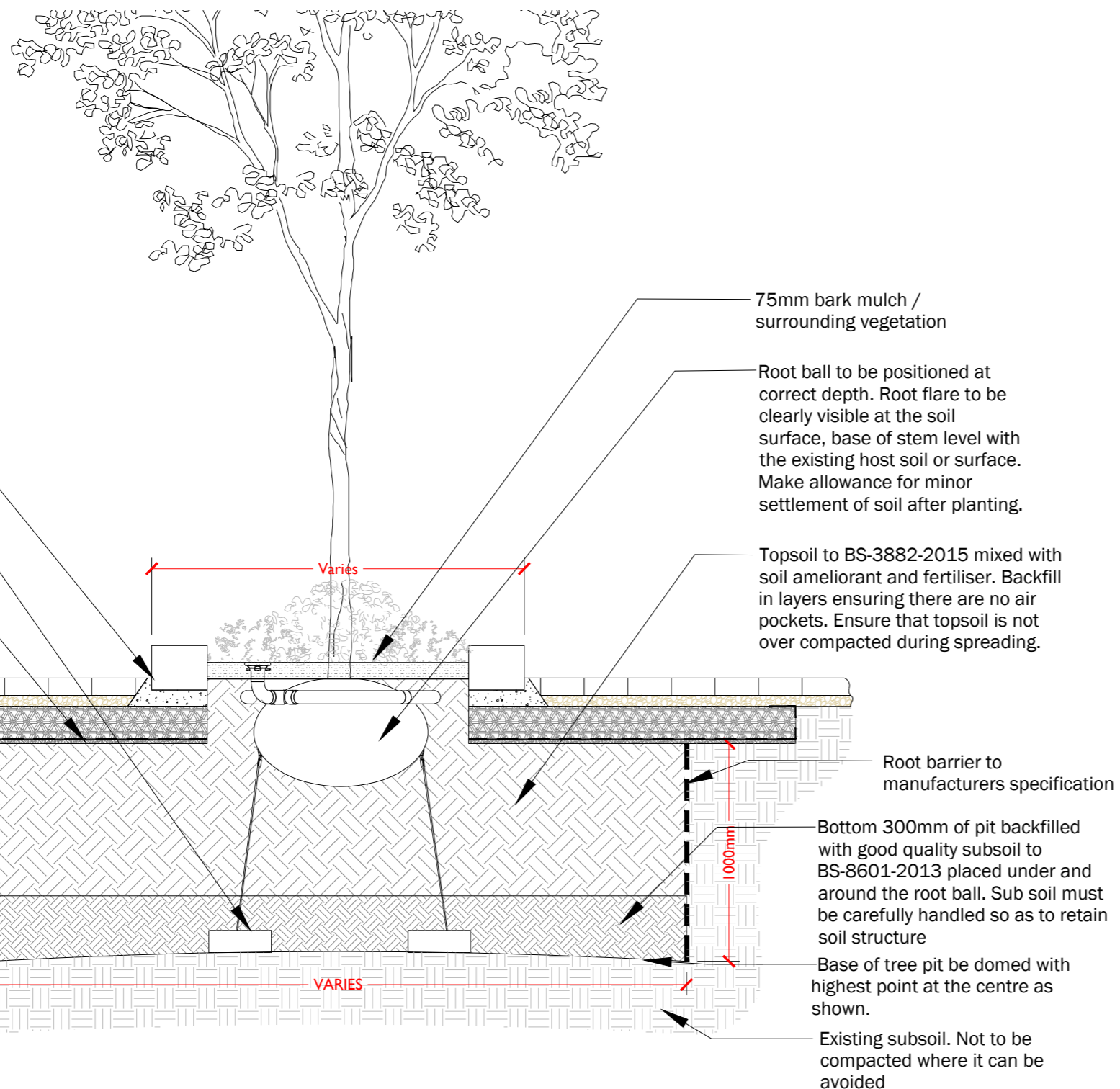

TREE PLANTING IN SOFT LANDSCAPE DETAIL: 1:40 DOUBLE-STAKED AND TIED

To be used in planting of trees with specified Up to 16-18 girth

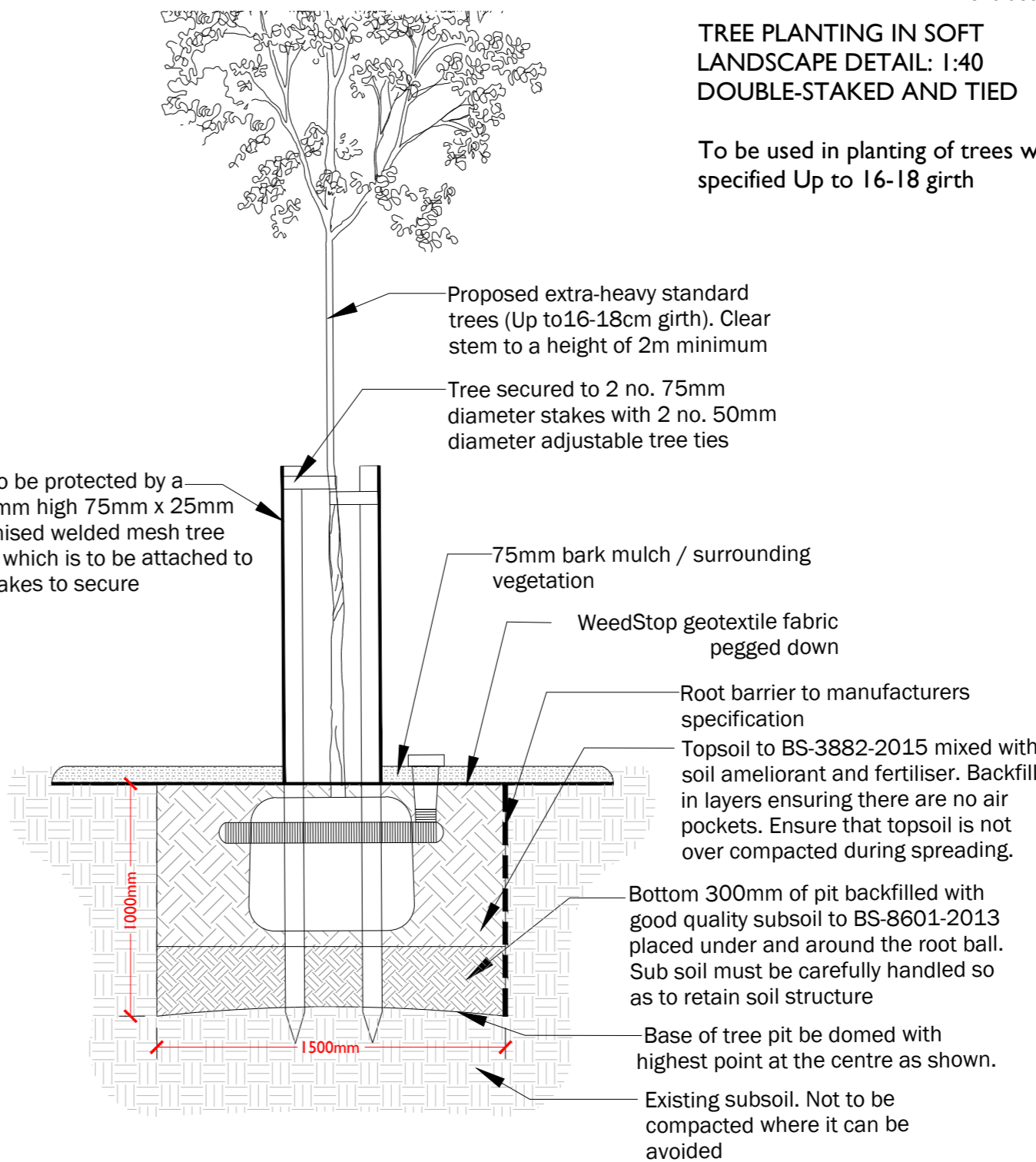

GENERAL NOTES

This drawing is to be used for planting information only, and is subject to alteration through changes to the site layout or until approved by the area designer.

Any species substitution by the contractor must be verified with the Landscape Architect through the Job Architect.

This layout must be checked in accordance with NHBC Standards 2013 (Chapter 4.2 - Building Near Trees & Chapter 9.2 Drives, Paths and Landscaping) by the Regional Engineer prior to implementation.

Excavations: Contractors must ensure that they have full information relating to service and drainage positions before undertaking any excavations.

Root barriers to be used in association with tree planting adjacent to kerbs / services / footpaths etc. (Greenleaf ReRoot products or similar application, in accordance with manufacturer's instructions).

Details to be read in accordance with LLA Detailed planting proposals 1619 A2 01, 02

Rev	Date	Description

Title:	Tree Planting Details
Project:	Heyford Park, Bicester Parcel 6
Client:	Dorchester Living
Date:	June 2017
Scale:	1:40 @A2
Drawing No:	1619 A2 03
Rev:	

T: +44 (0)1279 647044 E: office@lizlake.com www.lizlake.com

COPYRIGHT Liz Lake Associates
Information contained in this drawing is confidential and may not be used for any purpose other than that for which the drawing is supplied without prior written authority of Liz Lake Associates. This drawing is copyright and may not be copied except within the agreed conditions of supply.

BASE MAPPING:
Reproduced from Ordnance Survey map data by permission of Ordnance Survey © Crown copyright 2014. Licence No. 100007136.
© Crown copyright and database rights 2014
Ordnance Survey Licence No. 0100031673
This drawing may contain information and/or mapping from a number of sources and its accuracy should be verified on site.

Stansted:
Unit 1, The Exchange,
9 Station Road,
Stansted, CM24 8BE

t +44 (0)1279 647044
e office@lizlake.com
www.lizlake.com

Bristol:
1 Host Street,
Bristol, BS1 5BU

t +44 (0)117 927 1786
e office@lizlake.com
www.lizlake.com

Nottingham:
Suite 201,
20 Fletcher Gate,
Nottingham NG1 2FZ

t +44 (0)115 784 3566
e office@lizlake.com
www.lizlake.com

LIZ LAKE
ASSOCIATES
LANDSCAPE ARCHITECTS

- Landscape Design
- Urban Design
- Residential
- Public Realm
- Masterplanning
- Landscape Planning
- Heritage Landscapes
- Gardens and Estates
- Restoration and Conversion
- Places of Worship
- Expert Witness
- Hospitality
- Education
- Retail / Office
- Community
- Ecology
- Arboriculture
- 3D / Graphic Design