



HODKINSON



**Sustainable
Construction
Statement**

Crest Nicholson Midlands

Oxford Road, Bodicote

Final

Simon Gowing
BSc (Hons), MSc, MEI

November 2018

DOCUMENT CONTROL RECORD

REPORT STATUS: FINAL

Version	Date	Reason for issue	Author	Checked by	Approved for Issue by Project Manager
v.1	29.10.18	Final	SG		SG
v.2	08.11.18	Final	SG	CS/CB	SG

ABOUT HODKINSON CONSULTANCY

Our team of technical specialists offer advanced levels of expertise and experience to our clients. We have a wide experience of the construction and development industry and tailor teams to suit each individual project.

We are able to advise at all stages of projects from planning applications to handover.

Our emphasis is to provide innovative and cost effective solutions that respond to increasing demands for quality and construction efficiency.

This report has been prepared by Hodkinson Consultancy using all reasonable skill, care and diligence and using evidence supplied by the design team, client and where relevant through desktop research.

Hodkinson Consultancy can accept no responsibility for misinformation or inaccurate information supplied by any third party as part of this assessment.

This report may not be copied or reproduced in whole or in part for any purpose, without the agreed permission of Hodkinson Consultancy of Harrow, London.

Executive Summary

The purpose of this Sustainable Construction Statement is to demonstrate that the proposed Reserved Matters application for 95 new homes at Oxford Road by Crest Nicholson in Cherwell District Council is considered sustainable, as measured against relevant local and national planning policies and in accordance with the requirements of Condition 20 of the outline consent.

Through the incorporation of sustainable design and construction methods, energy and water saving measures and waste reduction techniques, a good quality and sustainable development is proposed.

The key sustainability features outlined in this Sustainability Statement are listed below:

- > **Carbon Dioxide Reduction:** The development will target a 19% reduction in Regulated CO₂ emissions through energy efficiency, including waste water heat recovery, and PV panels;
- > **Renewable Energy:** PV panels are proposed across the site, providing a total 38 kWp total energy generation;
- > **Water efficiency:** Flow control devices and water efficient fixtures and fittings will be installed in all dwellings to target a maximum internal daily water consumption of 105 litres/person/day;
- > **Waste and recycling:** Adequate facilities will be provided for domestic and construction related waste, including segregated bins for refuse, recycling and food/garden waste collection;
- > **Materials:** Where practical, new building materials will be sourced locally to reduce transportation pollution and support the local economy. New materials will be selected based on their environmental impact and responsible suppliers will be used where possible; and
- > **Sustainable construction:** The site will aim to achieve a 'Beyond Best Practice' score with the Considerate Constructors Scheme and will closely monitor construction site impacts.

CONTENTS

Executive Summary	2
1. INTRODUCTION	5
2. DEVELOPMENT OVERVIEW	7
3. RELEVANT PLANNING POLICY	10
Ministerial Statement and Deregulation Act	12
Energy Targets Summary	13
4. ENERGY AND CO₂ CONSERVATION	14
Energy Strategy	14
Building Regulations Part L (2013) Baseline	14
Energy Efficiency Measures	15
Decentralised Energy	20
Low Carbon and Renewable Energy	21
5. WATER REDUCTION	25
6. WASTE MANAGEMENT	26
7. MATERIALS	28
8. SURFACE WATER RUN-OFF	29
9. SUSTAINABLE CONSTRUCTION	31
CONCLUSION	33
APPENDICES	34
Appendix A Cherwell District Energy Statement Template	
Appendix B CO ₂ Calculations Summary Sheet (Energy Efficiency)	
Appendix C Building Regulations Part L (2013) Compliance Reports	
Appendix D Dwelling Emission Rate (DER) Worksheets	

Appendix E Low and Zero Carbon Technologies Summary

Appendix F SAP 2012 PV Calculation and indicative layout

Appendix G CO₂ Calculations Summary Sheet (With PV)

Appendix H Water Efficiency Calculator

1. INTRODUCTION

- 1.1** This Sustainable Construction Statement has been prepared by Hodkinson Consultancy, a specialist energy and environmental consultancy for planning and development, appointed by Crest Nicholson Midlands.
- 1.2** This Statement sets out the sustainable design and construction measures included in the Reserved Matters planning application for the proposed development at Bodicote in Cherwell.

Planning History

- 1.3** Outline consent for 95 new homes was awarded on 8th January 2015 (14/02156/OUT). As part of this consent Condition 20 states the following:

“No development shall commence until a Sustainable Construction Statement has been submitted to and approved in writing by the Local Planning Authority. The Statement shall demonstrate which sustainable construction methods shall be used in the development to achieve, as far as practicably possible, zero carbon development including but not limited to:

(i) Minimising both energy demands and energy loss;

(ii) Maximising passive solar lighting and natural ventilation;

(iii) Maximising resource efficiency;

(iv) Incorporating the use of recycled and energy efficient materials;

(v) Incorporating the use of locally sourced building materials;

(vi) Reducing waste and pollution and making adequate provision for the recycling of waste;

(vii) Making use of sustainable drainage methods;

(viii) Reducing the impact on the external environment and maximising opportunities for cooling and shading; and

(ix) Making use of the embodied energy within buildings wherever possible and re-using materials where proposals involve demolition or redevelopment.

The development shall thereafter be carried out in full accordance with the approved Statement.

Reason - In the interests of sustainability and to deliver low carbon development, in accordance with Policy ESD3 of the Cherwell Local Plan 2011-2031: Part 1 and the National Planning Policy Framework.”

Sustainable Construction Statement Structure and Methodology

- 1.4** The formulation of the Sustainable Construction Statement has taken into account several important objectives, including:
- > To demonstrate conformance with the requirements of Condition 20 of the Outline consent;
 - > To achieve a viable reduction in CO₂ emissions with an affordable, deliverable and technically appropriate strategy;
 - > To minimise the negative impact of the proposed development on both the local and wider climate and environment;
 - > To achieve the highest viable levels of sustainable design and construction; and
 - > To create a pleasant, safe and friendly living environment that will be flexible to its residents' needs.
- 1.5** This Sustainable Construction Statement does not duplicate the work of the technical reports prepared in support of the application, but presents the findings in the overall context of sustainability.
- 1.6** **Chapter 2** provides an introduction to the site and the proposed development.
- 1.7** **Chapter 3** sets out the relevant national and local policy documents which have been used to guide and inform the sustainability strategy for the proposed development.
- 1.8** **Chapters 3 to 9** outline the sustainability strategy of the proposed development in relation to the policy documents listed in Chapter 3.
- 1.9** **Chapter 10** provides a summary of the key sustainability features associated with the proposed development.

2. DEVELOPMENT OVERVIEW

Site Location

2.1 The proposed development site to the south of the village of Bodicote is shown in Figure 1 below.



Figure 1: Site Location – Map data © 2017 Google

Proposed Development

2.2 Figure 2 overleaf illustrates the proposed site layout.

2.3 The accommodation schedule for the development is presented in Table 1 overleaf. A total of 95 dwellings are proposed for this application inline with the Outline Consent.



Figure 2: Proposed Composite Site Layout - (Pegasus Design)

2.4 The development includes 62 open markets homes, 21 affordable homes, and 12 intermediate (shared ownership) homes, see Table 1 below.

Table 1: Accommodation Schedule

House Type	No. Beds	No. of Units
<i>Open Market (62 homes)</i>		
Sandown	2	6
Hartley	3	4
Huntingdon	3	4
Langford	3	4
Halstead	3	8
Avon	4	4
Somerton	4	3
Calder	4	3
Radley	4	10
Caldwick	4	8
Tindall	5	4
Adderbury	5	4
<i>Affordable (21 homes)</i>		
AH2B	2	3
AH2B LTH	2	7
AH2B WC	2	1
AH3B	3	4
AH3B LTH	3	2
<i>Intermediate (12 homes)</i>		
AH2B	2	8
AH3B	3	4
TOTAL		95

3. RELEVANT PLANNING POLICY

- 3.1 The following planning policies and requirements have informed the sustainable design of the proposed development.

National Policy: NPPF

- 3.2 The revised National Planning Policy Framework (NPPF) was published on the 24th July 2018 and sets out the Government's planning policies for England.
- 3.3 The NPPF provides a framework for achieving sustainable development, which has been summarised as "meeting the needs of the present without compromising the ability of future generations to meet their own needs" (Resolution 42/187 of the United National General Assembly). At the heart of the framework is a presumption in favour of sustainable development.
- 3.4 The document states that the planning system has three overarching objectives which are interdependent and need to be pursued in mutually supportive ways:
- 3.5 **An economic objective** – to help build a strong, responsive and competitive economy, by ensuring that sufficient land of the right types is available in the right places and at the right time to support growth, innovation and improved productivity; and by identifying and coordinating the provision of infrastructure;
- 3.6 **A social objective** – to support strong, vibrant and healthy communities, by ensuring that a sufficient number and range of homes can be provided to meet the needs of present and future generations; and by fostering a well-designed and safe built environment, with accessible services and open spaces that reflect current and future needs and support communities' health, social and cultural well-being; and
- 3.7 **An environmental objective** – to contribute to protecting and enhancing our natural, built and historic environment; including making effective use of land, helping to improve biodiversity, using natural resources prudently, minimising waste and pollution, and mitigating and adapting to climate change, including moving to a low carbon economy.

Local Policy: Cherwell District Council

- 3.8 Condition 20 of the Outline consent refers to policy ESD 3 of the Cherwell local plan (2015). The local authority also provides an Energy Statement template to help address this condition. The requirements of this are addressed in Chapter 4 of this report.
- 3.9 Policy ESD 3 states the following:

All new residential development will be expected to incorporate sustainable design and construction technology to achieve zero carbon development through a combination of fabric energy efficiency, carbon compliance and allowable solutions in line with Government policy.

Cherwell District is in an area of water stress and as such the Council will seek a higher level of water efficiency than required in the Building Regulations, with developments achieving a limit of 110 litres/person/day.

The strategic site allocations identified in this Local Plan are expected to provide contributions to carbon emissions reductions and to wider sustainability.

All development proposals will be encouraged to reflect high quality design and high environmental standards, demonstrating sustainable construction methods including but not limited to:

- > Minimising both energy demands and energy loss*
- > Maximising passive solar lighting and natural ventilation*
- > Maximising resource efficiency*
- > Incorporating the use of recycled and energy efficient materials*
- > Incorporating the use of locally sourced building materials*
- > Reducing waste and pollution and making adequate provision for the recycling of waste*
- > Making use of sustainable drainage methods*
- > Reducing the impact on the external environment and maximising opportunities for cooling and shading (by the provision of open space and water, planting, and green roofs, for example); and*
- > Making use of the embodied energy within buildings wherever possible and re-using materials where proposals involve demolition or redevelopment.*

Should the promoters of development consider that individual proposals would be unviable with the above requirements; 'open-book' financial analysis of proposed developments will be expected so that an independent economic viability assessment can be undertaken. Where it is agreed that an economic viability assessment is required, the cost shall be met by the promoter.

3.10 Later information provided by the local authority makes it clear that they would support an Energy Strategy which demonstrated how the requirements of ESD 2 have been addressed, even though this policy is not specifically addressed in Condition 20.

3.11 Policy ESD 2 (Energy Hierarchy and Allowance Solutions) sets out the following:

- > *In seeking to achieve carbon emissions reductions, we will promote an 'energy hierarchy' as follows:*
- > *Reducing energy use, in particular by the use of sustainable design and construction measures*
- > *Supplying energy efficiently and giving priority to decentralised energy supply*
- > *Making use of renewable energy*
- > *Making use of allowable solutions.*

Ministerial Statement and Deregulation Act

- 3.12** **Cherwell's Local Plan (2011-2031) policy ESD 3** sets an expectation for new residential development to achieve a zero carbon development through a combination of fabric energy efficiency, carbon compliance and allowable solutions in line with Government policy.
- 3.13** Whilst the requirement of the policy is acknowledged, the **Ministerial Statement** from the Department for Communities and Local Government and the subsequent **Deregulation Bill 2014** stipulates that local planning authorities should no longer require any level of the Code for Sustainable Homes to be achieved by new development.
- 3.14** The Government has stated that, from then, the energy performance requirements in Building Regulations will be set at a level equivalent to the (outgoing) Code for Sustainable Homes Level 4.
- 3.15** Further to this, it is noted that the published Government White Paper '**Fixing the Foundations**' stated that it does not intend to proceed with the zero carbon Allowable Solutions carbon offsetting scheme, or the proposed 2016 increase in on-site energy efficiency standards. These energy efficiency standards have been incorporated in Part L of the Building Regulations through the Target Fabric Energy Efficiency (TFEE) criterion.
- 3.16** The Code Level 4 CO₂ equivalent is a 19% reduction in Regulated CO₂ over Part L (2013) of the Building Regulations, and it is this target that the development at Bodicote is addressing.
- 3.17** The remainder of this report sets out how these policy requirements have been addressed.

Energy Targets Summary

- 3.18** The Energy Strategy will target a 19% reduction in Regulated CO₂ emissions sitewide. The zero carbon target requested in Condition 20 is deemed impractical without Allowable Solutions which no longer an option.

- 3.19** A 19% target is in line with the most recent Governmental information provided by the Ministerial Statement and Deregulation Acts. This is a challenging target and is considered very sustainable.

4. ENERGY AND CO₂ CONSERVATION

- 4.1 The Cherwell District Council Energy Statement Template which summarises this section can be found in Appendix A.

Energy Strategy

- 4.2 The formulation of the energy strategy for the proposed development to achieve the maximum viable reduction in Regulated CO₂ emissions is in line with the Energy Hierarchy outlined in the Local Plan Policy ESD 2. As set out in Chapter 3, this has been established to be a minimum of 19% reduction over Part L (2013).
- 4.3 This includes:
- > Reducing energy use, in particular by the use of sustainable design and construction measures;
 - > Supplying energy efficiently, and giving priority to decentralised energy supply;
 - > Making use of renewable energy;
 - > Making use of allowable solutions.
- 4.4 This statement first establishes a baseline assessment of the energy demands and associated CO₂ emissions for the development based on current Building Regulations (2013). It will then outline the energy measures that enable this, as well as local policy targets, to be met.

Building Regulations Part L (2013) Baseline

Methodology

- 4.5 The estimated annual energy demand for the proposed development has been calculated using Standard Assessment Procedure (SAP 2012) methodology. SAP calculates the Regulated energy demands associated with hot water, space heating and fixed electrical items.

Baseline

- 4.6 The Building Regulations compliant baseline case provides that the homes meet the Target Emission Rate (TER). Table 2 below show the Building Regulations (2013) compliant Regulated emissions for the whole site. This is shown in greater detail in Appendix B.

Table 2: Building Regulations (2013) Baseline

	Regulated CO ₂ (Tonnes/year)
Baseline Emissions	180

Energy Efficiency Measures

- 4.7 The first step of a sustainable energy strategy is to reduce energy demand. It is therefore the Applicant's intention that energy efficiency measures will be prioritised over the generation of renewable energy to meet a demand that need not exist and in accordance with the energy hierarchy.
- 4.8 The energy efficiency measures outlined in this Chapter will be incorporated into the design to enable the proposed development to exceed Building Regulations (2013) through energy efficiency measures alone.

Insulation Standards

- 4.9 The dwellings elements will incorporate enhanced insulation in the building envelope (walls, roofs, floors and glazing) to achieve average U-values better than those required by Part L (2013) Building Regulations. These are likely to include:
- > Double glazing with a U-value of 1.30 W/m².K (soft low E-coating, estimated G-value of 0.63);
 - > External walls with a U-value of 0.21 W/m².K;
 - > Party walls will be fully insulated and sealed (achieving an effective U-value of 0.00W/m².K);
 - > Ground Floor U-value will range between 0.15-0.19 W/m².K depending on perimeter to area ratio of the unit;
 - > Roof U-values will be improved to 0.11 W/m².K.

Air Tightness and Ventilation

- 4.10 Air tightness standards will conform to, and exceed, Approved Document Part L requirements. By reducing air leakage loss and convective bypass of insulation, an improvement in the design air permeability rate from 10m³/hr.m² to 5m³/hr.m² or less will further reduce space heating requirements. Apartments will target 4m³/hr.m².

- 4.11 It is proposed to install Parts L & F compliant extract fans to all houses (System 1 – natural ventilation) and Mechanical Extraction Ventilation (System 3 - MEV) to apartments. These systems will remove stale air and odours from kitchens and bathrooms.
- 4.12 The selected MEV units will have a Specific Fan Power (SFP) lower than 0.25 W/l/s.
- 4.13 Additionally, all homes will have openable windows and therefore the ability to naturally ventilate should the occupant desire. Convective ventilation and night purging of heat will therefore be facilitated.

Thermal Bridging

- 4.14 In well insulated buildings, as much as 30% of heat loss can occur through thermal bridges, which occur when highly conductive elements (e.g. metal studs) in the wall construction enable a low resistance escape route for heat. An improvement over the SAP default y-value may be required for compliance with the required standards.
- 4.15 To ensure the Fabric Energy Efficiency target is achieved a mix of bespoke, Accredited Construction Details (ACDs), and Aircrete Association (APA) details will be used. These have a significantly lower heat loss values for each thermal bridge junction (psi- value) than the SAP default.
- 4.16 Figure 3 illustrates the benefits of reducing thermal bridges.

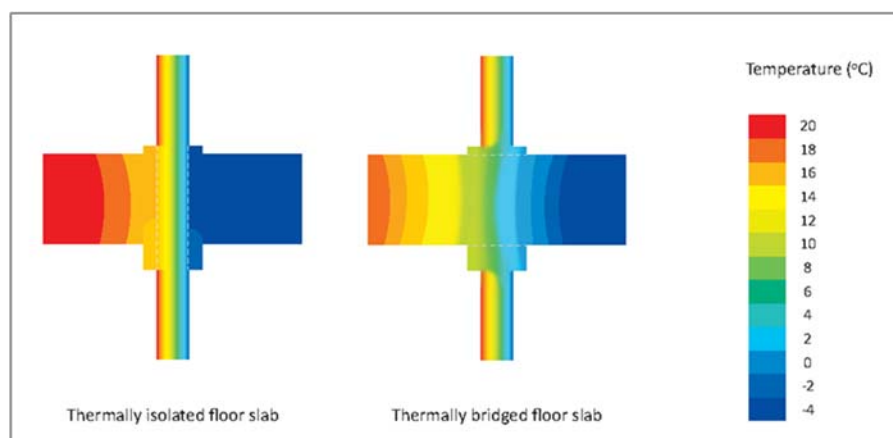

Figure 3: Thermal Bridging (SCI P380 2012)

Space Heating & Hot Water

- 4.17 The space heating requirement of the proposed development will be reduced by the fabric and air tightness measures detailed above.
- 4.18 The combination of the above measures will create highly energy efficient homes.

- 4.19** All dwellings will be installed with a low NO_x high efficiency SEDBUK 'A' rated boiler. These systems have at least an 89% efficiency rating (SAP 2009) and are Energy Saving Trust recommended.
- 4.20** A compatible weather compensator can be applied to the boiler system to further improve the boiler efficiency. The compensator adjusts the systems emitters (i.e. modulating the circulating radiator temperature) to compensate for changes in outdoor temperature automatically.
- 4.21** The space heating systems will include time and zoning controls. This will allow the occupants to have a flexible and efficient way of controlling heating throughout the dwelling.
- 4.22** A Hot Water Heat Recovery (WWHR) System A will be installed in each dwelling and connected to (where feasible) to each bathroom or shower room. These systems recover heat from waste water through a heat exchanger from the waste water during showers or when bath water is drained. The recovered heat is used to pre-heat cold mains water before entering the boiler reducing the fuel required to reach temperature.
- 4.23** WWHR should be installed on all plots and connected to all bath and/or shower rooms.

Limiting the Risk of Summer Overheating

- 4.24** Improving passive solar gains has to be balanced with the risk of summer overheating. Minimising the risk of summer overheating is important so as to ensure that homes are adapted to climate change and remain comfortable to occupy in the future. An illustrative strategy is presented here that enables dwellings to pass the overheating test. The sample SAP calculations undertaken do not show a risk of overheating within the SAP criterion with a 0.63 G-factor. Building Regulation Compliance Reports have been included in Appendix C.
- 4.25** Open-able windows will be used across the proposed development and will enable cross-ventilation, convective-ventilation and night purging. These concepts are illustrated in Figure 4 and will reduce the build-up of heat within homes.

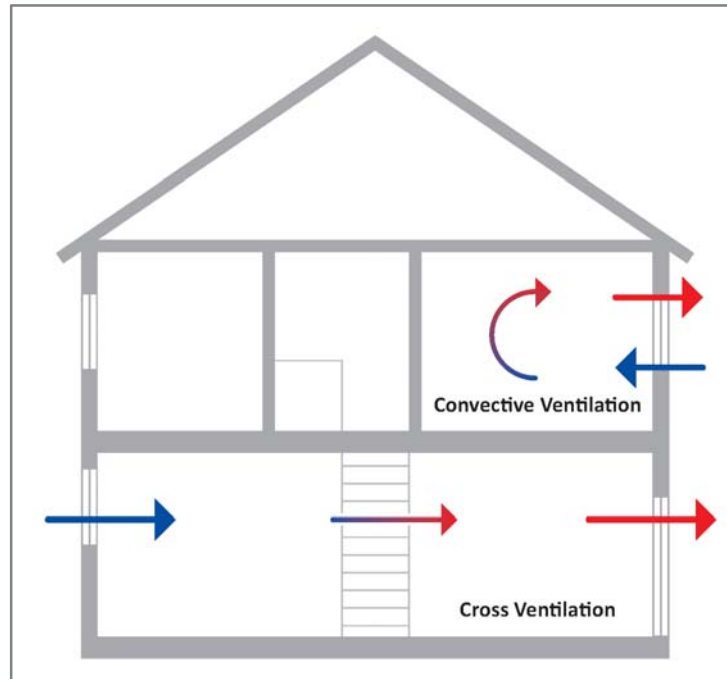

Figure 4: Natural Ventilation

- 4.26** If required, security measures can be put in place to enable ground floor dwellings to safely open their windows.

Lighting

- 4.27** All internal lighting and fittings in the dwellings will be energy efficient lighting (≤ 40 lumens per Watt)
- 4.28** All external lighting, and any security lighting, will be energy efficient and adequately controlled using PIR sensors, daylight cut-off sensors or time switches where possible. This will ensure the conservation of energy when the lighting is not in use.



Appliances (Unregulated Energy Use)

- 4.29** It is very difficult to design and construct homes to reduce the unregulated electricity demands, because this is almost entirely dependent on the occupant of a home and can vary substantially. However, the Applicant is committed to ensuring that all efforts are made to enable the residents to minimise their unregulated electricity consumption. Advice will be provided to all occupants in the form of a Home User Guide on how to minimise electricity consumption. This includes advice on purchasing low-energy devices as well as ensuring that they are used efficiently. It has been shown that the provision of such information can significantly reduce energy use.

- 4.30** On average, home appliances can account for around 45% of a household’s annual electricity bill. The choice of energy efficient appliances and the effective use of them will not only reduce unregulated CO₂ emissions but will save the occupants money.
- 4.31** Where provided, white goods will aim to be energy efficient in line with the ratings outlined in Table 3 and the resident purchase of them promoted through the provision of information on the EU Labelling Scheme contained within the Home Information Manual.

Table 3: Energy Efficient White Goods

Appliance	Energy Efficiency Rating
Fridges, freezers and fridge-freezers	A+
Dishwashers	A
Washing machines	A
Washer Dryers	B
Tumble dryers	B

- 4.32** Energy display devices, which can monitor electricity and primary heating fuel consumption, may also be provided to each of the dwellings. This can empower the occupants to be more aware of their usage and therefore make energy and cost savings, where possible.

CO₂ Emissions Following the Application of Energy Efficiency Measures

- 4.33** It can be seen in Table 4 that the energy efficiency measures detailed above enable Building Regulations (2013) to be exceeded through these measures alone.

Table 4: Energy Efficiency - Total Regulated CO₂

	Regulated CO ₂ (Tonnes/yr)
Building Regulations (2013) Baseline	180
After Energy Efficiency measures	162
Reduction Achieved	10%

- 4.34** The building meets the Target Emission Rate (TER) and the Target Fabric Energy Efficiency (TFEE) requirements of Building Regulations Part L1A 2013.
- 4.35** Further calculations including Dwelling Emission Rate (DER) worksheets on representative dwelling types can be seen in Appendix C and D.

Decentralised Energy

- 4.36** In line with Policy ESD 4 of the Local Plan, the feasibility of decentralised heating networks to provide energy in an efficient manner does not need to be evaluated for residential developments of fewer than 400 units (less than 50 in off-gas areas). However, for completion, reasons against decentralised energy have been provided as this is the next step in the Energy Hierarchy after energy efficiency.
- 4.37** The inclusion of decentralised heating has been investigated in terms of appropriateness to the proposed development, and, to be in line with the priorities for this energy strategy, whether heating decentralised is the best technology to provide the greatest reductions in CO₂ emissions.
- 4.38** There are several disadvantages associated with applying Combined Heat and Power (CHP) to a small development of this nature:
- > **Diversity of demand:** CHP is best suited to developments where there is a diversity of energy demand. A large mixed-use scheme, or a large residential scheme (>1000 homes) will have extended periods of the day in which there is a continuous demand for heat. In these circumstances, a CHP engine can operate consistently to generate electricity, with heat as a by-product. On a small residential scheme such as this, there will be long periods of low or very low heat demand with two sharp peaks in demand for hot water in the morning and evening. Sharp peaks in demand must be dealt with either by running CHP engines for shorter hours (resulting in a decreased potential for CO₂ reductions) with storage of heat in large central thermal buffer vessels with substantial space (and height) requirements, OR ‘dumping’ of heat by connecting CHP engines to heat rejection plant at roof level, or in very well ventilated basements.
 - > **Thermal Storage:** To compensate for fluctuations in the demand for heat, thermal buffers will be required to store CHP thermal output. To store heat without the need for dumping will require a large store that can take >4hrs of charging. On a scheme of this size, such a thermal store could double the size of the plant room.
 - > **Distribution Heat Losses:** Thermal stores are a source of standing heat losses, as are even the best insulated heating distribution networks. When communal systems satisfy a small and intermittent demand, these standing losses will represent a large part (often over 30%) of total demand. CO₂ savings gained within the dwelling through association with CHP may be considerably reduced by the additional losses associated with the network. Furthermore, the build-up of this heat in residential circulation spaces proves hard to dissipate and can increase to an uncomfortable level. Strategies for the rapid ventilation of this heat reduce the efficiency of the system as a whole by throwing heat away.
 - > **CO₂ emissions:** Small Combined Heat and Power (CHP) engines are much less efficient than larger ones, having a worse heat to power ratio (typically >2) than larger ones. This means that they do not enable as large a CO₂ reduction as for a larger development, which would be able to

utilise a larger and more efficient CHP engine. This means that more gas must be burnt in proportion to the electricity generated, meaning they are less effective at reducing CO₂ emissions.

- 4.39** Installed Costs: The installed cost of a heat distribution network benefits from economies of scale when compared with individual heating systems. On a smaller scheme the upfront cost of commercial heating plant and CHP systems must be divided into relatively few numbers of units. In addition, export licenses for grid connection are harder to negotiate on favourable terms for small developments. Grid connection at favourable feed-in-rates is essential to offset the cost of additional gas used by CHP engines (circa twice the gas as gas boilers).
- 4.40** Running Costs: Fixed costs associated with the management and operation of a communal plant room must be shared by occupants as part of an energy standing charge; hence the fewer the number of units, the greater the cost for the individual occupant. CHP engines impose additional running costs because contracts for maintenance and replacement parts are typically handled by specialist companies.
- 4.41** It has therefore been concluded that, due to the size and density of the proposed development, CHP cannot be recommended for the scheme.
- 4.42** With CHP considered as unfeasible due to scale and cost, any decentralised heat network also becomes unfeasible due to the high fixed operation and maintenance costs associated with operating an energy centre for so few final customers.

Low Carbon and Renewable Energy

- 4.43** It can be seen from Table 4 previously that Building Regulations (2013) have been exceeded across the site with energy efficiency measures alone.
- 4.44** Low carbon and renewable energy technologies (LZCT) will be required to assist the development meeting the CO₂ emission reduction target. LZCT are summarised below, for more information see Appendix E.
- 4.45** Due to the prioritisation and optimisation of energy efficiency measures, the requirement for low carbon and renewable energy technologies is reduced.
- 4.46** However, in order to meet a 19% CO₂ reduction over 2013 Building Regulations a further reduction of 4.3 tonnes CO₂/year is still required.

Biomass Boiler

- 4.47** Biomass boilers generate heat on a renewable basis as they are run on biomass fuel which is carbon neutral. A biomass boiler would require a central plant room and heat distribution network and would therefore be liable to high capital and running costs.
- 4.48** Whilst technically feasible, a biomass boiler is not appropriate for this development for the same reasons as CHP.

Ground and Air Source Heat Pumps (ASHPs and GSHPs)

- 4.49** Heat Pumps upgrade energy from the ground or air and utilise it for space heating and hot water.
- 4.50** Heat Pumps are able to provide substantial reductions in energy. However, GSHPs require costly ground excavation works to bury the coils – boreholes would be required for the proposed development due to the high space requirements of ground coils and this is not possible on this site.
- 4.51** Air Source Heat Pumps are a more economical alternative to GSHPs as they do not require ground works. However, the performance of ASHPs can be lower than for GSHPs are therefore the reductions in CO2 are correspondingly low.
- 4.52** Whilst reducing energy significantly, heat pumps replace gas as the heating fuel with electricity, which is more carbon intensive. The result of this is that heat pumps do not enable sufficient reductions of CO2 emissions for policy compliance. Electricity is also a more expensive fuel than gas, so energy bills are not necessarily reduced by heat pumps as much as by other technologies.
- 4.53** It has therefore been concluded that heat pumps are not a viable technology for the proposed development.

Micro Wind Turbines

- 4.54** Small rooftop wind turbines are designed to generate electricity from the wind for use within each dwelling.
- 4.55** Urban rooftop wind turbines do not generally perform sufficiently to well to warrant their installation, due to the low and turbulent wind conditions present. They are therefore likely to remain technically unfeasible.
- 4.56** It has therefore been concluded that wind turbines are not a suitable technology for the proposed development.

Solar Thermal (hot water) Panels

- 4.57** Solar thermal panels use the sun's energy to generate hot water for each dwelling. Due to the seasonality of solar radiation, solar thermal panels can provide up to ~60% of a dwellings hot water demand, with the remainder being provided as top-up by the conventional gas boiler. They are a robust technology that provides substantial benefits to residents in terms of 'free' energy.
- 4.58** Solar thermal panels are generally installed on the roofs of dwellings, with panels facing as close to south as possible to maximise their efficiency. A 100m² dwelling would typically require ~4m² of solar panels.
- 4.59** Solar thermal panels are a technically viable strategy, although it is unlikely that they would enable sufficient CO₂ reductions for policy compliance without additional technologies also being specified.
- 4.60** It has therefore been concluded that PV panels represent a more appropriate solar technology for this development.

Proposed Technology: Photovoltaic (PV) Panels

- 4.61** Unlike solar thermal panels, PV panels are not constrained by the hot water demand of the dwellings. PV panels are good at enabling substantial reductions in CO₂ emissions as a result.
- 4.62** It has been concluded that PV panels represent the most viable renewable energy technology for the proposed development. They are technically and economically viable for the development and enable the most substantial reductions in CO₂ emissions.
- 4.63** It has been estimated that 38 kWp of PV panels is required and would be able to fit onto the south-east roofs of the maisonette block and about 30 houses:
- > South-east facing; 29kWp, pitch of 30°;
 - > South-west facing 9kWp, pitch of 45°.
- 4.64** The total 38 kWp can be distributed over the dwellings roofs and provide onsite electricity for occupants and well as Feed in Tariff income. It has been assumed the PV would be prioritised on to the affordable homes as to benefit from the delivered energy savings.
- 4.65** It has been calculated that this would achieve a 19% reduction in Regulated CO₂ emissions over Building Regulations (2013) across the whole development.
- 4.66** The SAP 2012 PV calculation and indicative possible layout is attached as Appendix F.

CO₂ Emissions Following Renewable Energy Measures

- 4.67 The inclusion of PV panels results in a total 19% reduction over the Building Regulations Part L (2013) baseline case (see Table 5).
- 4.68 These calculations can be seen in further detail in Appendix G.

Table 5: Low Carbon & Renewable Energy Measures - Total Regulated CO₂ reduction

	Regulated CO₂ (Tonnes/year)
Building Regulations (2013) Baseline	180
After Energy Efficiency and Solar PV	145
Reduction Achieved	19.1%

5. WATER REDUCTION

Internal Water Efficiency

- 5.1 Water conservation is at the core of sustainable development. Every person in the UK uses approximately 150 litres of water per day which has continued to rise by 1% since 1930. Water is a finite resource and during times of drought supplies can run low. Many natural ecosystems in the United Kingdom can suffer as a result of water abstraction.
- 5.2 Reducing water consumption will not only help to preserve our water sources but will save energy. As much as 25% of a household's energy consumption is used for heating water. As such, internal water consumption will be significantly reduced through the use of practical and hygienic water saving measures.



Residential Water Use

- 5.3 All new dwellings will target a minimum water efficiency standard of 105 litres/person/day in accordance with the above planning policy and the optional tighter Building Regulations Approved Document G requirement (110 litres/person/day). An evaluation of the proposed fixtures and fittings will be undertaken during the detailed design however an illustrative strategy to achieve this water target is set out in Table 6 below and the Water Efficiency Calculator in Appendix H.

Table 6: Residential Sanitary ware

Installation Type	Water Capacity/Flow Rate
WC	6/4 litres dual flush
Bath	160 litres capacity
Shower	8 litres/ minute flow rate
Kitchen Tap	5 litres/ minute flow rate
Basin Tap	4 litres/ minute flow rate
Washing Machine	8.17 litres/ kg
Dishwasher	1.25 litres/ place setting

External Water Efficiency

- 5.4 All of the houses will be provided with rainwater butts in the private back gardens to reduce the demand on potable water and promote effective use of our water supplies. These will be appropriately sized and capable of harvesting rainwater for external irrigation and car washing.

6. WASTE MANAGEMENT

- 6.1 Waste reduction and recycling is another key challenge of sustainable development. The waste hierarchy, illustrated in Figure 5 below, prioritises those waste management options according to what is best for the environment.

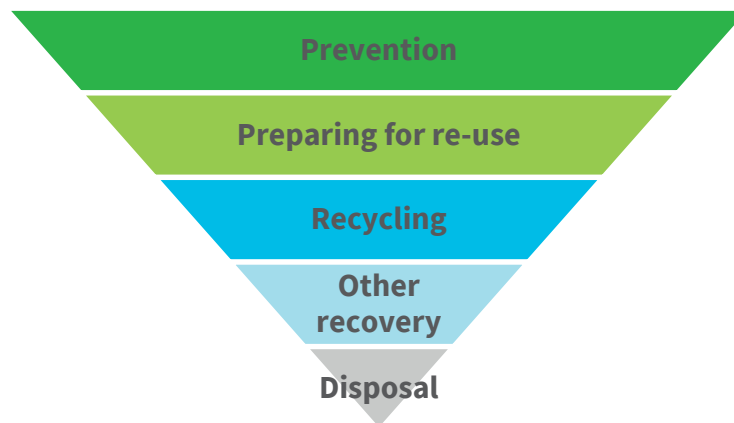

Figure 5: Waste Hierarchy

- 6.2 The waste hierarchy places great importance on the prevention of waste in the first instance through using less material in the designing and manufacturing processes. Once waste is created, the hierarchy then prioritises the re-use of materials through cleaning, repairing and refurbishing whole items. It then gives priority to recycling which is the turning of waste into a new product or substance, including composting. ‘Other recovery’ including incineration with energy recovery and anaerobic digestion and then final disposal (to landfill or incineration without energy recovery) are seen as the least favourable options.

Household Waste

- 6.3 Crest Nicholson is committed to following the above waste hierarchy and reducing waste sent to landfill. As such, adequate storage is to be provided to each of the proposed dwellings, where both recyclable and non-recyclable waste can be stored in accordance with Cherwell’s waste collection service.
- 6.4 In addition, space will be provided for segregated recycling waste bins within the kitchen areas. This will involve the installation of recycling bins, where waste can be segregated into paper, glass, cans, plastic and cardboard, if necessary.



- 6.5 Brown bins with indoor caddies for garden and food waste are provided by the local authority for composting.
- 6.6 A Home User Guide will be provided which will explain how the Cherwell waste collection scheme operates to ensure residents are aware.

Construction Waste

- 6.7 The reduction of construction waste not only minimises environmental impacts through ensuring the responsible use of resources and waste disposal, but can also significantly reduce construction costs for the developer.
- 6.8 Prior to construction, Crest Nicholson will develop a Site Waste Management Plan which will establish ways of minimising waste at source, assess the use, reuse and recycling of materials on and off-site and prevent illegal waste activities. This plan will then be disseminated to all relevant personnel on and off-site.
- 6.9 The following waste minimisation actions will be considered:
 - > Consider opportunities for zero cut and fill to avoid waste from excavation or groundworks;
 - > Design for standardisation of components and the use of fewer materials;
 - > Design for off-site or modular build;
 - > Return packaging for reuse;
 - > Consider community reuse of surplus materials or offcuts; and
 - > Engage with supply chains and include waste minimisation initiatives and targets in tenders and contracts.
- 6.10 As part of their commitment to divert construction waste from landfill, Crest Nicholson will regularly monitor and record the site's waste reduction performance. This will be compared against a target benchmark where at least 85% (by volume) of non-hazardous waste is to be diverted from landfill.

7. MATERIALS

Environmental Impact

- 7.1 New building materials will be selected, where possible, to ensure that they minimise environmental impact and have low embodied energy – from manufacture, transportation and operational stages, through to eventual demolition and disposal.
- 7.2 All insulation materials will have an Ozone Depleting Potential (ODP) of zero and a Global Warming Potential (GWP) of less than 5. In addition, all decorative paints and varnishes will meet the relevant standards in order to reduce the emission levels of volatile organic compounds (VOCs).

Crest Nicholson Sustainable Procurement Policy

- 7.3 The Crest Nicholson Sustainable Procurement Policy sets out the commitment to specifying sustainable materials and technologies, and to developing long term partnerships with suppliers, contractors and sub-contractors to promote social responsibility and environmental stewardship.
- 7.4 Crest Nicholson will assess the sustainability of their products and services against social, environmental and economic criteria. Suppliers or contractors who do not meet the minimum standards for health and safety, human rights or labour shall not be appointed.
- 7.5 Where economically sustainable and where the agreed social standards are met, Crest Nicholson will give preference to products which:
 - > Have a lower environmental impact, specifically lower levels of embodied energy;
 - > Are locally sourced, contain recycled content, or are reclaimed;
 - > Are responsibly sourced through third party certification schemes including ISO 14001 or EMAS.
- 7.6 Preference will be given to the use of locally sourced materials and local suppliers, where viable. This will benefit the local economy as well as having environmental benefits through reduced transportation.
- 7.7 Major materials will be responsibly and legally sourced from manufacturers with environmental management systems and chain of custody certificates, where appropriate.
- 7.8 Timber used on the site, including timber used in the construction phase, such as hoarding, fencing and scaffolding, will be sourced from sustainable sources (e.g. PEFC and FSC) where possible.



8. SURFACE WATER RUN-OFF

Sustainable Drainage Systems

- 8.1** A Flood Risk Assessment, incorporating a Surface Water Management strategy, has been prepared by Forge Engineering Design.
- 8.2** A range of SuDS are set-out in this document as suitable for the development. These would not only help to attenuate surface water but will provide the necessary water treatment.
- > Soakaways;
 - > Filter strips adjacent to roads;
 - > Swales;
 - > Pervious paving.
- 8.3** Sustainable Drainage Systems (SuDS) are designed to maximise opportunities and benefits that can be secured from surface water management. The four pillars of SuDS are:
- > **Water Quantity** – Controls the quantity of runoff to support the management of flood risk and maintain and protect the natural cycle of water.
 - > **Water Quality** – Manages the quality of runoff to prevent pollution.
 - > **Amenity** – Creates and sustains better places for people.
 - > **Biodiversity** – Creates and sustains better places for nature.
- 8.4** The SuDS Hierarchy, illustrated in Figure 6 overleaf, sets out the preferred method of selecting which system should be used.
- 8.5** Living roofs, basins and ponds, and filter strips and swales are the most sustainable as they contribute to flood reduction, pollution reduction and benefit surrounding landscapes and wildlife.

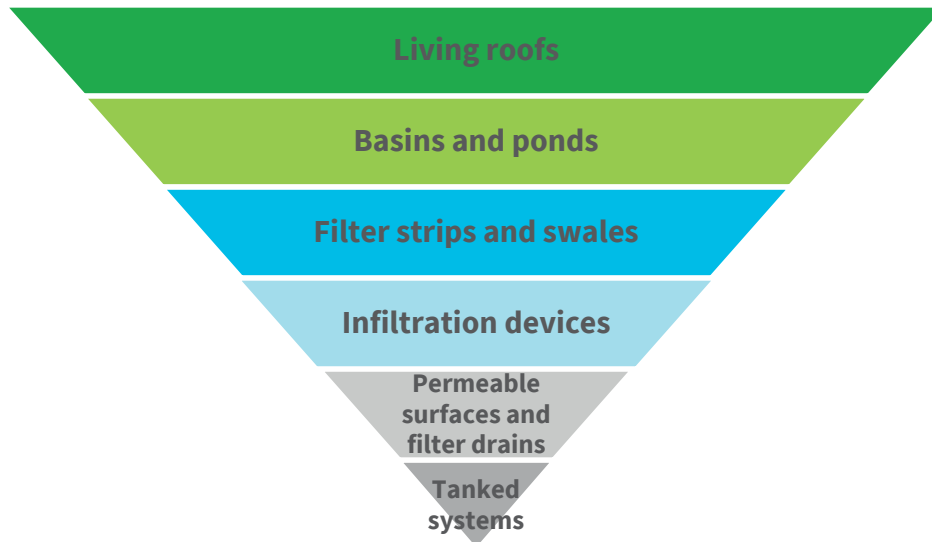

Figure 6: SuDS Hierarchy

9. SUSTAINABLE CONSTRUCTION

- 9.1 Sustainable construction is described as involving the prudent use of existing and new resources and the efficient management of the construction process. This includes the following measures:
- > Reducing waste during construction and demolition and sorting waste on site where practical;
 - > Reducing the risk of statutory nuisance to neighbouring properties as much as possible through effective site management;
 - > Controlling dust and emissions from demolition and construction; and
 - > Complying with protected species legislation.

Considerate Constructors Scheme

- 9.2 The development site will be registered with the Considerate Constructors Scheme. This is designed to encourage environmentally and socially considerate ways of working, to reduce any adverse impacts arising from the construction process. As commonly known, the Considerate Constructors Scheme aims are as follows:
- > Enhancing the appearance;
 - > Respecting the community;
 - > Protecting the environment;
 - > Securing everyone's safety;
 - > Caring for the workforce.
- 9.3 The site will target 'Beyond Best Practice' certification, achieving a score of between 35 out of 50, with all of the five sections scoring at least seven points.

Monitoring Construction Site Impacts

- 9.4 During the construction processes, control procedures will be put in place to minimise noise and dust pollution and roads will be kept clean. The management systems will generally comprise procedures and working methods that are approved by the development team together with commercial arrangements to ensure compliance.

9.5 Further to the above, additional measures will be adopted to minimise the impact on the local area during construction. This will include the limiting of air and water pollution in accordance with best practice principles, as well as the recording, monitoring and displaying of energy and water use from site activities during construction.

9.6 In terms of construction traffic, this will be minimised by restricting deliveries and arrival times in order to manage potential impacts on existing and future occupants. Work will be limited to appropriate hours to be agreed with the Council, and suppressors will be used to reduce noise from machinery.



CONCLUSION

- 9.7 The purpose of this Sustainable Construction Statement is to demonstrate that the proposed Reserved Matters application for 95 new homes at Oxford Road by Crest Nicholson in Cherwell District Council is considered sustainable, as measured against relevant local and national planning policies and in accordance with the requirements of Condition 20 of the outline consent.
- 9.8 Through the incorporation of sustainable design and construction methods, energy and water saving measures and waste reduction techniques, a good quality and sustainable development is proposed.
- 9.9 The key sustainability features outlined in this Sustainability Statement are listed below:
- > **Carbon Dioxide Reduction:** The development will target a 19% reduction in Regulated CO₂ emissions through energy efficiency measures, including waste water heat recovery, and PV panels;
 - > **Renewable Energy:** PV panels are proposed across the site, providing a total 38 kWp total energy generation;
 - > **Water efficiency:** Flow control devices and water efficient fixtures and fittings will be installed in all dwellings to target a maximum internal daily water consumption of 105 litres/person/day;
 - > **Waste and recycling:** Adequate facilities will be provided for domestic and construction related waste, including segregated bins for refuse, recycling and food/garden waste collection;
 - > **Materials:** Where practical, new building materials will be sourced locally to reduce transportation pollution and support the local economy. New materials will be selected based on their environmental impact and responsible suppliers will be used where possible; and
 - > **Sustainable construction:** The site will aim to achieve a 'Beyond Best Practice' score with the Considerate Constructors Scheme and will closely monitor construction site impacts.

APPENDICES

Appendix A

Cherwell District Energy Statement Template

Appendix B

CO₂ Calculations Summary Sheet (Energy Efficiency)

Appendix C

Building Regulations Part L (2013) Compliance Reports

Appendix D

Dwelling Emission Rate (DER) Worksheets

Appendix E

Low and Zero Carbon Technologies Summary

Appendix F

SAP 2012 PV Calculation and indicative layout

Appendix G

CO₂ Calculations Summary Sheet (With PV)

Appendix H

Water Efficiency Calculator

Appendix A

Cherwell District Energy Statement Template

Implementation Advice Note: Annex 1
Information Requirements for Policies ESD 2, 3, 4, and 5 of the Cherwell Local
Plan: Energy Statement Template

This guidance has been prepared in advance of the Sustainable Buildings in Cherwell Supplementary Planning Document which will provide more detailed guidance on these matters.

Introduction

Applicants submitting proposals for major residential development (over 10 dwellings), and all non-residential development are required to submit a statement demonstrating compliance with the energy hierarchy set out in Policy ESD 2. Compliance with Policy ESD 2 will be demonstrated through the application of Policies ESD 3, 4, and 5.

The Council has produced this template which can be used by applicants to demonstrate compliance with ESD 2, 3, 4 and 5.

The majority of the questions in the template require yes/no answers, which will demonstrate to the planning case officer whether the requirements of each of the policies have been addressed.

The statement should be submitted with a planning application whether the application is in outline, reserved matters or is a full planning application.

The processing of an application not submitted with this information is likely to be delayed until the information is provided.

Energy Statement Template

Section A – Summary of compliance with Policy ESD 2:

Q1: Please summarise how the principles of the energy hierarchy set out in Policy ESD 2 have been applied (note: it is advisable to complete this summary section last, after the rest of this statement has been completed).

Please refer to Chapter 4: Energy and CO₂ conservation of the Sustainable Construction Statement produced by Hodkinson Consultancy.

It details the fabric first approach to reduce the initial demand of heat within dwellings. This is done through improved insulation, consideration to heat loss through thermal bridges, efficient heating (including waste water heat recovery), and ventilation systems.

Decentralised energy has been investigated and deemed inappropriate for this development.

Renewable energy technologies have been reviewed and Photovoltaic Panels selected as most suitable to provide CO₂ reductions.

Section B – How does the proposed development promote the reduction of energy use?

The first bullet point of the Energy Hierarchy set out in Policy ESD 2 requires that developments are designed to use less energy, for example through sustainable design and construction measures.

Q2: In what way does the development reflect fabric efficiency in its construction?

Please see Chapter 4: Energy and CO₂ conservation of the Sustainable Construction Statement produced by Hodkinson Consultancy. Part L(2013) of the Building Regulations has a fabric energy efficiency target. The dwellings proposed at the development improve on this target (the TFEE) by 13% (see appendix B).

The inclusion of low heat loss thermal elements (low u-values and psi-values) reduces the demand for space heating. High efficiency boilers with weather compensators have been selected to ensure when heating is required, it is produced as in a very efficient manner.

Hot water usage has been made more efficient by utilising waste water heat recovery, which utilises waste hot shower water or bath water to pre-heat incoming water to the boiler to reduce fuel use.

Q3: In what other ways has the building been designed to use less energy?

Consideration into unregulated energy use has been considered. The most effective way of reducing energy use is through occupant education. This is undertaken by the applicant through home user guides.

Q4: For non-residential development, has the development been designed to meet BREEAM 'Very Good'? (as required by Policy ESD 3)

Not applicable (no non-residential units)

NB At outline application stage, a commitment will need to be made to BREEAM 'Very Good' and applicants can expect that the requirement to build to this standard, unless superseded by higher national standards at the time the development is constructed, will be attached to the outline consent as a condition on the subsequent reserved matters application.

For reserved matters or full applications, the BREEAM Design Stage Assessment will be required to be submitted with the application. If granted, a condition will be applied to the consent requiring the submission of the Post Construction Stage Assessment prior to occupation of the development.

Section C – How does the proposed development promote supplying energy efficiently and giving priority to decentralised energy supply?

The second bullet point of Policy ESD 2 requires energy to be supplied to a development in an efficient way, with priority given to decentralised energy supply.

Q6: For all residential developments for 100 dwellings or more; all residential developments in off gas areas for 50 dwellings or more; and all applications for non domestic developments above 1000 sqm, has a feasibility assessment for District Heating/Combined Heat and Power been undertaken? (as required by Policy ESD 4)

Yes - This scheme is fewer than 100 units, however consideration into decentralised heat has been undertaken and deemed inappropriate.

Please submit the feasibility assessment with this statement

Please see Chapter 4 of the submitted Sustainable Construction Statement

Q7: Does the feasibility assessment indicate that decentralised energy systems are deliverable as part of the development?

No

Q8: If yes, do decentralised energy systems form part of the proposed development? (as required by Policy ESD 4)

Not Applicable

NB The feasibility assessment is required for all applications whether in outline, reserved matters, or full application form.

If the feasibility assessment indicates that decentralised energy systems are deliverable, conditions will be attached to the consent to secure the provision of such systems.

Please refer to the separate advice note on the kinds of issues to be considered in undertaking the district heating feasibility assessment.

Section D – How does the proposed development promote the use of renewable energy?

The third bullet point of Policy ESD 2 requires developments to use renewable energy.

Q9: For all residential developments for 100 dwellings or more; all residential developments in off gas areas for 50 dwellings or more; and all applications for non domestic developments above 1000 sqm, has a feasibility assessment for onsite renewable energy provision been undertaken? (as required by Policy ESD 5)

Yes – This scheme is fewer than 100, however Renewable technologies have been considered for suitability. See Chapter 4: Energy and CO₂ conservation of the Sustainable Construction Statement produced by Hodkinson Consultancy and Appendix E

Please submit the feasibility assessment with this statement

Please see Chapter 4: Energy and CO₂ conservation of the Sustainable Construction Statement produced by Hodkinson Consultancy and Appendix E

Q10: Does the feasibility assessment indicate that onsite renewable energy systems are deliverable as part of the development?

Yes

Q11: If yes, does onsite renewable energy form part of the proposed development? (as required by Policy ESD 5)

Yes – PV selected.

NB The feasibility assessment is required for all applications whether in outline, reserved matters, or full application form.

If the feasibility assessment indicates that renewable energy systems are deliverable, conditions will be attached to the consent to secure the provision of such systems.

Please refer to the separate advice note on undertaking the renewable energy feasibility assessment.

Allowable Solutions

Please note that the Council does not now intend to require information on the final stage of the energy hierarchy in Policy ESD 2 relating to Allowable Solutions.

Appendix B

CO₂ Calculations Summary Sheet (Energy Efficiency)

CO₂ Emissions at Be Lean Stage

Unit Type Description	Individual			Number of Units	Total			Emissions Rate Improvement
	Unit Floor Area	Dwelling Emissions Rate	Target Emissions Rate		Total Floor Area	Dwelling Emissions Rate	Target Emissions Rate	
	m ²	kg CO ₂ /m ² /year	kg CO ₂ /m ² /year		m ²	kg CO ₂ /year	kg CO ₂ /year	-
ADDERBURY (detached)	115	15.7	17.0	4	459	7,221	7,788	7.3%
AH2B (semi-detached/end terrace)	78	16.0	18.3	18	1,408	22,497	25,808	12.8%
AH3B (mid terrace)	78	14.7	17.5	1	78	1,149	1,366	15.8%
CALDER (detached)	138	14.3	16.2	3	413	5,911	6,709	11.9%
CALDERWICK (detached)	165	13.9	15.7	8	1,319	18,340	20,717	11.5%
Ground Floor apartment	44	18.4	22.3	2	87	1,608	1,944	17.3%
AH23B (semi-detached/end terrace)	93	15.7	17.9	10	925	14,481	16,545	12.5%
HALSTEAD (semi-detached)	111	14.6	15.7	8	889	13,015	13,989	7.0%
HARTLEY AND SANDOWN (semi-detached)	93	15.2	17.4	10	930	14,088	16,193	13.0%
LANFORD AND HUNTINGFORD (detached)	101	16.3	17.9	8	809	13,224	14,503	8.8%
RADLEY (detached)	147	16.0	17.3	10	1,471	23,579	25,392	7.1%
SOMERTON (detached)	139	15.2	16.4	7	972	14,806	15,971	7.3%
Top Floor apartment	55	16.3	20.0	2	110	1,790	2,198	18.5%
TINDALL (detached)	194	12.8	13.9	4	778	9,965	10,782	7.6%
Total for All Units					10,649	161,674	179,904	10.1%

Fabric Energy Efficiency

Unit Type Description	Individual			Number of Units	Total			Fabric Energy Efficiency Improvement
	Unit Floor Area	Dwelling Fabric Energy Efficiency	Target Fabric Energy Efficiency		Total Floor Area	Dwelling Fabric Energy Efficiency	Target Fabric Energy Efficiency	
	m ²	kWh/m ² /year	kWh/m ² /year		m ²	kWh/year	kWh/year	-
ADDERBURY (detached)	115	49.7	56.4	4	459	22,821	25,897	11.9%
AH2B (semi-detached/end terrace)	78	45.0	50.4	18	1,408	63,315	70,989	10.8%
AH3B (mid terrace)	78	38.8	45.5	1	78	3,031	3,558	14.8%
CALDER (detached)	138	44.9	55.8	3	413	18,556	23,041	19.5%
CALDERWICK (detached)	165	47.0	58.0	8	1,319	62,039	76,496	18.9%
Ground Floor apartment	44	48.1	56.5	2	87	4,198	4,929	14.8%
AH23B (semi-detached/end terrace)	93	46.8	52.7	10	925	43,287	48,745	11.2%
HALSTEAD (semi-detached)	111	42.7	47.5	8	889	38,002	42,273	10.1%
HARTLEY AND SANDOWN (semi-detached)	93	44.1	50.6	10	930	40,973	47,050	12.9%
LANFORD AND HUNTINGFORD (detached)	101	49.1	56.3	8	809	39,725	45,582	12.8%
RADLEY (detached)	147	54.7	63.2	10	1,471	80,429	92,986	13.5%
SOMERTON (detached)	139	51.3	58.2	7	972	49,880	56,554	11.8%
Top Floor apartment	55	40.8	49.1	2	110	4,484	5,397	16.9%
TINDALL (detached)	194	45.0	51.7	4	778	35,001	40,239	13.0%
Floor Weighted Average				95	10,649	47.5	54.8	13.4%

Appendix C

Building Regulations Part L (2013) Compliance Reports

L1A 2013 - Regulations Compliance Report

Design - Draft



This design draft submission provides evidence towards compliance with Part L of the Building Regulations, in accordance with Appendix C of AD L1A. It has been carried out using Approved SAP software. It has been prepared from plans and specifications and may not reflect the 'as built' property. This report covers only items included within the SAP and is not a complete report of regulations compliance.

Assessor name	Mr Simon Gowing	Assessor number	9641
Client		Last modified	29/10/2018
Address	ADDERBURY Oxford Road, Bodicaote, OX15		

Check	Evidence	Produced by	OK?
Criterion 1: predicted carbon dioxide emission from proposed dwelling does not exceed the target			
TER (kg CO ₂ /m ² .a)	Fuel = N/A Fuel factor = 1.00 TER = 16.96	Authorised SAP Assessor	
DER for dwelling as designed (kg CO ₂ /m ² .a)	DER = 15.72	Authorised SAP Assessor	
Are emissions from dwelling as designed less than or equal to the target?	DER 15.72 < TER 16.96	Authorised SAP Assessor	Passed
Is the fabric energy efficiency of the dwelling as designed less than or equal to the target?	DFEE 49.7 < TFEE 56.4	Authorised SAP Assessor	Passed

Criterion 2: the performance of the building fabric and the heating, hot water and fixed lighting systems should be no worse than the design limits

Fabric U-values

Are all U-values better than the design limits in Table 2?	Element	Weighted average Highest		Produced by	OK?
	Wall	0.21 (max 0.30)	0.21 (max 0.70)	Authorised SAP Assessor	Passed
	Party wall	(no party wall)			
	Floor	0.15 (max 0.25)	0.15 (max 0.70)		
	Roof	0.11 (max 0.20)	0.21 (max 0.35)		
	Openings	1.30 (max 2.00)	1.30 (max 3.30)		

Thermal bridging

How has the loss from thermal bridges been calculated?	Thermal bridging calculated from linear thermal transmittances for each junction	Authorised SAP Assessor	
--	--	-------------------------	--

Heating and hot water systems

Does the efficiency of the heating systems meet the minimum value set out in the Domestic Heating Compliance Guide?	Main heating system: Mains gas, Regular boiler from database Potterton Promax 24 System ErP Efficiency = 89.00% - SEDBUK 2009 Minimum = 88.00%	Authorised SAP Assessor	Passed
Does the insulation of the hot water cylinder meet the standards set out in the Domestic Heating Compliance Guide?	Secondary heating system: None Cylinder volume = 250.00 litres Declared cylinder loss = 1.67kWh/day Maximum permitted cylinder loss = 2.56kWh/day Primary hot water pipes are insulated	Authorised SAP Assessor	Passed
Do controls meet the minimum controls provision set out in the Domestic Heating Compliance Guide?	Space heating control: Time and temperature zone control - plumbing circuit Hot water control: Boiler interlock (main system 1) Cylinder thermostat Separate water control	Authorised SAP Assessor	Passed

Check	Evidence	Produced by	OK?
Fixed internal lighting			
Does fixed internal lighting comply with paragraphs 42 to 44?	Schedule of installed fixed internal lighting Standard lights = 0 Low energy lights = 26 Percentage of low energy lights = 100% Minimum = 75 %	Authorised SAP Assessor	Passed
Criterion 3: the dwelling has appropriate passive control measures to limit solar gains			
Does the dwelling have a strong tendency to high summertime temperatures?	Overheating risk (June) = Not significant (20.05°) Overheating risk (July) = Slight (21.79°) Overheating risk (August) = Slight (21.49°) Region = Thames Thermal mass parameter = 191.00 Ventilation rate in hot weather = 4.00 ach Blinds/curtains = Dark-coloured curtain or roller blind	Authorised SAP Assessor	Passed
Criterion 4: the performance of the dwelling, as designed, is consistent with the DER			
Design air permeability (m ³ /h.m ² at 50Pa)	Design air permeability = 5.00 Max air permeability = 10.00	Authorised SAP Assessor	Passed
Mechanical ventilation system Specific fan power (SFP)	Not applicable	Authorised SAP Assessor	
Have the key features of the design been included (or bettered) in practice?	The following roofs have a U-value less than 0.13W/m ² K: • 400mm Mineral wool (0.11) Thermal bridging γ value (0.015) is less than 0.04	Authorised SAP Assessor	

L1A 2013 - Regulations Compliance Report

Design - Draft



This design draft submission provides evidence towards compliance with Part L of the Building Regulations, in accordance with Appendix C of AD L1A. It has been carried out using Approved SAP software. It has been prepared from plans and specifications and may not reflect the 'as built' property. This report covers only items included within the SAP and is not a complete report of regulations compliance.

Assessor name	Mr Simon Gowing	Assessor number	9641
Client		Last modified	29/10/2018
Address	AH2B -END Oxford Road, Bodicaote, OX15		

Check	Evidence	Produced by	OK?																		
Criterion 1: predicted carbon dioxide emission from proposed dwelling does not exceed the target																					
TER (kg CO ₂ /m ² .a)	Fuel = N/A Fuel factor = 1.00 TER = 18.33	Authorised SAP Assessor																			
DER for dwelling as designed (kg CO ₂ /m ² .a)	DER = 15.98	Authorised SAP Assessor																			
Are emissions from dwelling as designed less than or equal to the target?	DER 15.98 < TER 18.33	Authorised SAP Assessor	Passed																		
Is the fabric energy efficiency of the dwelling as designed less than or equal to the target?	DFEE 45.0 < TFEE 50.4	Authorised SAP Assessor	Passed																		
Criterion 2: the performance of the building fabric and the heating, hot water and fixed lighting systems should be no worse than the design limits																					
Fabric U-values																					
Are all U-values better than the design limits in Table 2?	<table border="1"> <thead> <tr> <th>Element</th> <th colspan="2">Weighted average Highest</th> </tr> </thead> <tbody> <tr> <td>Wall</td> <td>0.21 (max 0.30)</td> <td>0.21 (max 0.70)</td> </tr> <tr> <td>Party wall</td> <td>0.00 (max 0.20)</td> <td>N/A</td> </tr> <tr> <td>Floor</td> <td>0.15 (max 0.25)</td> <td>0.15 (max 0.70)</td> </tr> <tr> <td>Roof</td> <td>0.11 (max 0.20)</td> <td>0.11 (max 0.35)</td> </tr> <tr> <td>Openings</td> <td>1.30 (max 2.00)</td> <td>1.30 (max 3.30)</td> </tr> </tbody> </table>	Element	Weighted average Highest		Wall	0.21 (max 0.30)	0.21 (max 0.70)	Party wall	0.00 (max 0.20)	N/A	Floor	0.15 (max 0.25)	0.15 (max 0.70)	Roof	0.11 (max 0.20)	0.11 (max 0.35)	Openings	1.30 (max 2.00)	1.30 (max 3.30)	Authorised SAP Assessor	Passed
Element	Weighted average Highest																				
Wall	0.21 (max 0.30)	0.21 (max 0.70)																			
Party wall	0.00 (max 0.20)	N/A																			
Floor	0.15 (max 0.25)	0.15 (max 0.70)																			
Roof	0.11 (max 0.20)	0.11 (max 0.35)																			
Openings	1.30 (max 2.00)	1.30 (max 3.30)																			
Thermal bridging																					
How has the loss from thermal bridges been calculated?	Thermal bridging calculated from linear thermal transmittances for each junction	Authorised SAP Assessor																			
Heating and hot water systems																					
Does the efficiency of the heating systems meet the minimum value set out in the Domestic Heating Compliance Guide?	Main heating system: Mains gas, Combi boiler from database Potterton Promax Ultra Combi 33 ErP Efficiency = 89.10% - SEDBUK 2009 Minimum = 88.00% Secondary heating system: None	Authorised SAP Assessor	Passed																		
Does the insulation of the hot water cylinder meet the standards set out in the Domestic Heating Compliance Guide?	No hot water cylinder	Authorised SAP Assessor																			
Do controls meet the minimum controls provision set out in the Domestic Heating Compliance Guide?	Space heating control: Time and temperature zone control - plumbing circuit Hot water control: No hot water cylinder Boiler interlock (main system 1)	Authorised SAP Assessor	Passed																		

Check	Evidence	Produced by	OK?
Fixed internal lighting			
Does fixed internal lighting comply with paragraphs 42 to 44?	Schedule of installed fixed internal lighting Standard lights = 0 Low energy lights = 15 Percentage of low energy lights = 100% Minimum = 75 %	Authorised SAP Assessor	Passed
Criterion 3: the dwelling has appropriate passive control measures to limit solar gains			
Does the dwelling have a strong tendency to high summertime temperatures?	Overheating risk (June) = Not significant (18.96°) Overheating risk (July) = Slight (20.73°) Overheating risk (August) = Slight (20.53°) Region = Thames Thermal mass parameter = 250.00 Ventilation rate in hot weather = 4.00 ach Blinds/curtains = Dark-coloured curtain or roller blind	Authorised SAP Assessor	Passed
Criterion 4: the performance of the dwelling, as designed, is consistent with the DER			
Design air permeability (m ³ /h.m ² at 50Pa)	Design air permeability = 5.00 Max air permeability = 10.00	Authorised SAP Assessor	Passed
Mechanical ventilation system Specific fan power (SFP)	Not applicable	Authorised SAP Assessor	
Have the key features of the design been included (or bettered) in practice?	The following party walls have a U-value less than 0.2W/m ² K: • Party (0.00) The following roofs have a U-value less than 0.13W/m ² K: • Insulated at Joists (0.11)	Authorised SAP Assessor	

L1A 2013 - Regulations Compliance Report

Design - Draft



This design draft submission provides evidence towards compliance with Part L of the Building Regulations, in accordance with Appendix C of AD L1A. It has been carried out using Approved SAP software. It has been prepared from plans and specifications and may not reflect the 'as built' property. This report covers only items included within the SAP and is not a complete report of regulations compliance.

Assessor name	Mr Simon Gowing	Assessor number	9641
Client		Last modified	29/10/2018
Address	AH2B- MID Oxford Road, Bodicaote, OX15		

Check	Evidence	Produced by	OK?																		
Criterion 1: predicted carbon dioxide emission from proposed dwelling does not exceed the target																					
TER (kg CO ₂ /m ² .a)	Fuel = N/A Fuel factor = 1.00 TER = 17.47	Authorised SAP Assessor																			
DER for dwelling as designed (kg CO ₂ /m ² .a)	DER = 14.70	Authorised SAP Assessor																			
Are emissions from dwelling as designed less than or equal to the target?	DER 14.70 < TER 17.47	Authorised SAP Assessor	Passed																		
Is the fabric energy efficiency of the dwelling as designed less than or equal to the target?	DFEE 38.8 < TFEE 45.5	Authorised SAP Assessor	Passed																		
Criterion 2: the performance of the building fabric and the heating, hot water and fixed lighting systems should be no worse than the design limits																					
Fabric U-values																					
Are all U-values better than the design limits in Table 2?	<table border="1"> <thead> <tr> <th>Element</th> <th colspan="2">Weighted average Highest</th> </tr> </thead> <tbody> <tr> <td>Wall</td> <td>0.21 (max 0.30)</td> <td>0.21 (max 0.70)</td> </tr> <tr> <td>Party wall</td> <td>0.00 (max 0.20)</td> <td>N/A</td> </tr> <tr> <td>Floor</td> <td>0.15 (max 0.25)</td> <td>0.15 (max 0.70)</td> </tr> <tr> <td>Roof</td> <td>0.11 (max 0.20)</td> <td>0.11 (max 0.35)</td> </tr> <tr> <td>Openings</td> <td>1.30 (max 2.00)</td> <td>1.30 (max 3.30)</td> </tr> </tbody> </table>	Element	Weighted average Highest		Wall	0.21 (max 0.30)	0.21 (max 0.70)	Party wall	0.00 (max 0.20)	N/A	Floor	0.15 (max 0.25)	0.15 (max 0.70)	Roof	0.11 (max 0.20)	0.11 (max 0.35)	Openings	1.30 (max 2.00)	1.30 (max 3.30)	Authorised SAP Assessor	Passed
Element	Weighted average Highest																				
Wall	0.21 (max 0.30)	0.21 (max 0.70)																			
Party wall	0.00 (max 0.20)	N/A																			
Floor	0.15 (max 0.25)	0.15 (max 0.70)																			
Roof	0.11 (max 0.20)	0.11 (max 0.35)																			
Openings	1.30 (max 2.00)	1.30 (max 3.30)																			
Thermal bridging																					
How has the loss from thermal bridges been calculated?	Thermal bridging calculated from linear thermal transmittances for each junction	Authorised SAP Assessor																			
Heating and hot water systems																					
Does the efficiency of the heating systems meet the minimum value set out in the Domestic Heating Compliance Guide?	Main heating system: Mains gas, Combi boiler from database Potterton Promax Ultra Combi 33 ErP Efficiency = 89.10% - SEDBUK 2009 Minimum = 88.00% Secondary heating system: None	Authorised SAP Assessor	Passed																		
Does the insulation of the hot water cylinder meet the standards set out in the Domestic Heating Compliance Guide?	No hot water cylinder	Authorised SAP Assessor																			
Do controls meet the minimum controls provision set out in the Domestic Heating Compliance Guide?	Space heating control: Time and temperature zone control - plumbing circuit Hot water control: No hot water cylinder Boiler interlock (main system 1)	Authorised SAP Assessor	Passed																		

Check	Evidence	Produced by	OK?
Fixed internal lighting			
Does fixed internal lighting comply with paragraphs 42 to 44?	Schedule of installed fixed internal lighting Standard lights = 0 Low energy lights = 15 Percentage of low energy lights = 100% Minimum = 75 %	Authorised SAP Assessor	Passed
Criterion 3: the dwelling has appropriate passive control measures to limit solar gains			
Does the dwelling have a strong tendency to high summertime temperatures?	Overheating risk (June) = Not significant (18.86°) Overheating risk (July) = Slight (20.62°) Overheating risk (August) = Not significant (20.39°) Region = Thames Thermal mass parameter = 250.00 Ventilation rate in hot weather = 4.00 ach Blinds/curtains = Dark-coloured curtain or roller blind	Authorised SAP Assessor	Passed
Criterion 4: the performance of the dwelling, as designed, is consistent with the DER			
Design air permeability (m ³ /h.m ² at 50Pa)	Design air permeability = 5.00 Max air permeability = 10.00	Authorised SAP Assessor	Passed
Mechanical ventilation system Specific fan power (SFP)	Not applicable	Authorised SAP Assessor	
Have the key features of the design been included (or bettered) in practice?	The following party walls have a U-value less than 0.2W/m ² K: • Party (0.00) The following roofs have a U-value less than 0.13W/m ² K: • Insulated at Joists (0.11)	Authorised SAP Assessor	

L1A 2013 - Regulations Compliance Report

Design - Draft



This design draft submission provides evidence towards compliance with Part L of the Building Regulations, in accordance with Appendix C of AD L1A. It has been carried out using Approved SAP software. It has been prepared from plans and specifications and may not reflect the 'as built' property. This report covers only items included within the SAP and is not a complete report of regulations compliance.

Assessor name	Mr Simon Gowing	Assessor number	9641
Client		Last modified	29/10/2018
Address	CALDER - DET CALDER - DET, Bodicaote, OX15		

Check	Evidence	Produced by	OK?																		
Criterion 1: predicted carbon dioxide emission from proposed dwelling does not exceed the target																					
TER (kg CO ₂ /m ² .a)	Fuel = N/A Fuel factor = 1.00 TER = 16.24	Authorised SAP Assessor																			
DER for dwelling as designed (kg CO ₂ /m ² .a)	DER = 14.31	Authorised SAP Assessor																			
Are emissions from dwelling as designed less than or equal to the target?	DER 14.31 < TER 16.24	Authorised SAP Assessor	Passed																		
Is the fabric energy efficiency of the dwelling as designed less than or equal to the target?	DFEE 44.9 < TFEE 55.8	Authorised SAP Assessor	Passed																		
Criterion 2: the performance of the building fabric and the heating, hot water and fixed lighting systems should be no worse than the design limits																					
Fabric U-values																					
Are all U-values better than the design limits in Table 2?	<table border="1"> <thead> <tr> <th>Element</th> <th colspan="2">Weighted average Highest</th> </tr> </thead> <tbody> <tr> <td>Wall</td> <td>0.20 (max 0.30)</td> <td>0.20 (max 0.70)</td> </tr> <tr> <td>Party wall</td> <td>(no party wall)</td> <td></td> </tr> <tr> <td>Floor</td> <td>0.16 (max 0.25)</td> <td>0.16 (max 0.70)</td> </tr> <tr> <td>Roof</td> <td>0.11 (max 0.20)</td> <td>0.11 (max 0.35)</td> </tr> <tr> <td>Openings</td> <td>1.21 (max 2.00)</td> <td>1.30 (max 3.30)</td> </tr> </tbody> </table>	Element	Weighted average Highest		Wall	0.20 (max 0.30)	0.20 (max 0.70)	Party wall	(no party wall)		Floor	0.16 (max 0.25)	0.16 (max 0.70)	Roof	0.11 (max 0.20)	0.11 (max 0.35)	Openings	1.21 (max 2.00)	1.30 (max 3.30)	Authorised SAP Assessor	Passed
Element	Weighted average Highest																				
Wall	0.20 (max 0.30)	0.20 (max 0.70)																			
Party wall	(no party wall)																				
Floor	0.16 (max 0.25)	0.16 (max 0.70)																			
Roof	0.11 (max 0.20)	0.11 (max 0.35)																			
Openings	1.21 (max 2.00)	1.30 (max 3.30)																			
Thermal bridging																					
How has the loss from thermal bridges been calculated?	Thermal bridging calculated from linear thermal transmittances for each junction	Authorised SAP Assessor																			
Heating and hot water systems																					
Does the efficiency of the heating systems meet the minimum value set out in the Domestic Heating Compliance Guide?	Main heating system: Mains gas, Regular boiler from database Potterton Promax 24 System ErP Efficiency = 89.00% - SEDBUK 2009 Minimum = 88.00% Secondary heating system: None	Authorised SAP Assessor	Passed																		
Does the insulation of the hot water cylinder meet the standards set out in the Domestic Heating Compliance Guide?	Cylinder volume = 250.00 litres Declared cylinder loss = 1.67kWh/day Maximum permitted cylinder loss = 2.56kWh/day Primary hot water pipes are insulated	Authorised SAP Assessor	Passed																		
Do controls meet the minimum controls provision set out in the Domestic Heating Compliance Guide?	Space heating control: Time and temperature zone control - plumbing circuit Hot water control: Boiler interlock (main system 1) Cylinder thermostat Separate water control	Authorised SAP Assessor	Passed																		

Check	Evidence	Produced by	OK?
Fixed internal lighting			
Does fixed internal lighting comply with paragraphs 42 to 44?	Schedule of installed fixed internal lighting Standard lights = 0 Low energy lights = 16 Percentage of low energy lights = 100% Minimum = 75 %	Authorised SAP Assessor	Passed
Criterion 3: the dwelling has appropriate passive control measures to limit solar gains			
Does the dwelling have a strong tendency to high summertime temperatures?	Overheating risk (June) = Not significant (18.52°) Overheating risk (July) = Not significant (20.19°) Overheating risk (August) = Not significant (19.93°) Region = Midlands Thermal mass parameter = 100.00 Ventilation rate in hot weather = 4.00 ach Blinds/curtains = Dark-coloured curtain or roller blind	Authorised SAP Assessor	Passed
Criterion 4: the performance of the dwelling, as designed, is consistent with the DER			
Design air permeability (m ³ /h.m ² at 50Pa)	Design air permeability = 5.00 Max air permeability = 10.00	Authorised SAP Assessor	Passed
Mechanical ventilation system Specific fan power (SFP)	Not applicable	Authorised SAP Assessor	
Have the key features of the design been included (or bettered) in practice?	The following roofs have a U-value less than 0.13W/m ² K: • 400mm mineral wool (0.11) • over entrance (0.11) Thermal bridging y value (0.036) is less than 0.04	Authorised SAP Assessor	

L1A 2013 - Regulations Compliance Report

Design - Draft



This design draft submission provides evidence towards compliance with Part L of the Building Regulations, in accordance with Appendix C of AD L1A. It has been carried out using Approved SAP software. It has been prepared from plans and specifications and may not reflect the 'as built' property. This report covers only items included within the SAP and is not a complete report of regulations compliance.

Assessor name	Mr Simon Gowing	Assessor number	9641
Client		Last modified	29/10/2018
Address	CALDWICK ALT - DET CALDER - DET, Bodicaote, OX15		

Check	Evidence	Produced by	OK?
Criterion 1: predicted carbon dioxide emission from proposed dwelling does not exceed the target			
TER (kg CO ₂ /m ² .a)	Fuel = N/A Fuel factor = 1.00 TER = 15.70	Authorised SAP Assessor	
DER for dwelling as designed (kg CO ₂ /m ² .a)	DER = 13.90	Authorised SAP Assessor	
Are emissions from dwelling as designed less than or equal to the target?	DER 13.90 < TER 15.70	Authorised SAP Assessor	Passed
Is the fabric energy efficiency of the dwelling as designed less than or equal to the target?	DFEE 47.0 < TFEE 58.0	Authorised SAP Assessor	Passed

Criterion 2: the performance of the building fabric and the heating, hot water and fixed lighting systems should be no worse than the design limits

Fabric U-values

Are all U-values better than the design limits in Table 2?	Element	Weighted average Highest		Produced by	OK?
	Wall	0.20 (max 0.30)	0.20 (max 0.70)	Authorised SAP Assessor	Passed
	Party wall	(no party wall)			
	Floor	0.16 (max 0.25)	0.16 (max 0.70)		
	Roof	0.11 (max 0.20)	0.11 (max 0.35)		
	Openings	1.21 (max 2.00)	1.30 (max 3.30)		

Thermal bridging

How has the loss from thermal bridges been calculated?	Thermal bridging calculated from linear thermal transmittances for each junction	Authorised SAP Assessor	
--	--	-------------------------	--

Heating and hot water systems

Does the efficiency of the heating systems meet the minimum value set out in the Domestic Heating Compliance Guide?	Main heating system: Mains gas, Regular boiler from database Potterton Promax 24 System ErP Efficiency = 89.00% - SEDBUK 2009 Minimum = 88.00%	Authorised SAP Assessor	Passed
	Secondary heating system: None		
Does the insulation of the hot water cylinder meet the standards set out in the Domestic Heating Compliance Guide?	Cylinder volume = 250.00 litres Declared cylinder loss = 1.67kWh/day Maximum permitted cylinder loss = 2.56kWh/day Primary hot water pipes are insulated	Authorised SAP Assessor	Passed
Do controls meet the minimum controls provision set out in the Domestic Heating Compliance Guide?	Space heating control: Time and temperature zone control - plumbing circuit Hot water control: Boiler interlock (main system 1) Cylinder thermostat Separate water control	Authorised SAP Assessor	Passed

Check	Evidence	Produced by	OK?
Fixed internal lighting			
Does fixed internal lighting comply with paragraphs 42 to 44?	Schedule of installed fixed internal lighting Standard lights = 0 Low energy lights = 16 Percentage of low energy lights = 100% Minimum = 75 %	Authorised SAP Assessor	Passed
Criterion 3: the dwelling has appropriate passive control measures to limit solar gains			
Does the dwelling have a strong tendency to high summertime temperatures?	Overheating risk (June) = Not significant (18.85°) Overheating risk (July) = Not significant (20.5°) Overheating risk (August) = Not significant (20.17°) Region = Midlands Thermal mass parameter = 100.00 Ventilation rate in hot weather = 4.00 ach Blinds/curtains = Dark-coloured curtain or roller blind	Authorised SAP Assessor	Passed
Criterion 4: the performance of the dwelling, as designed, is consistent with the DER			
Design air permeability (m ³ /h.m ² at 50Pa)	Design air permeability = 5.00 Max air permeability = 10.00	Authorised SAP Assessor	Passed
Mechanical ventilation system Specific fan power (SFP)	Not applicable	Authorised SAP Assessor	
Have the key features of the design been included (or bettered) in practice?	The following roofs have a U-value less than 0.13W/m ² K: • 400mm mineral wool (0.11)	Authorised SAP Assessor	

L1A 2013 - Regulations Compliance Report

Design - Draft



This design draft submission provides evidence towards compliance with Part L of the Building Regulations, in accordance with Appendix C of AD L1A. It has been carried out using Approved SAP software. It has been prepared from plans and specifications and may not reflect the 'as built' property. This report covers only items included within the SAP and is not a complete report of regulations compliance.

Assessor name	Mr Simon Gowing	Assessor number	9641
Client		Last modified	29/10/2018
Address	GF 1B Oxford Road, Bodicaote, OX15		

Check	Evidence	Produced by	OK?																		
Criterion 1: predicted carbon dioxide emission from proposed dwelling does not exceed the target																					
TER (kg CO ₂ /m ² .a)	Fuel = N/A Fuel factor = 1.00 TER = 22.28	Authorised SAP Assessor																			
DER for dwelling as designed (kg CO ₂ /m ² .a)	DER = 18.43	Authorised SAP Assessor																			
Are emissions from dwelling as designed less than or equal to the target?	DER 18.43 < TER 22.28	Authorised SAP Assessor	Passed																		
Is the fabric energy efficiency of the dwelling as designed less than or equal to the target?	DFEE 48.1 < TFEE 56.5	Authorised SAP Assessor	Passed																		
Criterion 2: the performance of the building fabric and the heating, hot water and fixed lighting systems should be no worse than the design limits																					
Fabric U-values																					
Are all U-values better than the design limits in Table 2?	<table border="1"> <thead> <tr> <th>Element</th> <th colspan="2">Weighted average Highest</th> </tr> </thead> <tbody> <tr> <td>Wall</td> <td>0.20 (max 0.30)</td> <td>0.20 (max 0.70)</td> </tr> <tr> <td>Party wall</td> <td>0.00 (max 0.20)</td> <td>N/A</td> </tr> <tr> <td>Floor</td> <td>0.17 (max 0.25)</td> <td>0.17 (max 0.70)</td> </tr> <tr> <td>Roof (no roof)</td> <td></td> <td></td> </tr> <tr> <td>Openings</td> <td>1.30 (max 2.00)</td> <td>1.30 (max 3.30)</td> </tr> </tbody> </table>	Element	Weighted average Highest		Wall	0.20 (max 0.30)	0.20 (max 0.70)	Party wall	0.00 (max 0.20)	N/A	Floor	0.17 (max 0.25)	0.17 (max 0.70)	Roof (no roof)			Openings	1.30 (max 2.00)	1.30 (max 3.30)	Authorised SAP Assessor	Passed
Element	Weighted average Highest																				
Wall	0.20 (max 0.30)	0.20 (max 0.70)																			
Party wall	0.00 (max 0.20)	N/A																			
Floor	0.17 (max 0.25)	0.17 (max 0.70)																			
Roof (no roof)																					
Openings	1.30 (max 2.00)	1.30 (max 3.30)																			
Thermal bridging																					
How has the loss from thermal bridges been calculated?	Thermal bridging calculated from linear thermal transmittances for each junction	Authorised SAP Assessor																			
Heating and hot water systems																					
Does the efficiency of the heating systems meet the minimum value set out in the Domestic Heating Compliance Guide?	Main heating system: Mains gas, Combi boiler from database Potterton Promax Ultra Combi 28 ErP Efficiency = 89.10% - SEDBUK 2009 Minimum = 88.00% Secondary heating system: None	Authorised SAP Assessor	Passed																		
Does the insulation of the hot water cylinder meet the standards set out in the Domestic Heating Compliance Guide?	No hot water cylinder	Authorised SAP Assessor																			
Do controls meet the minimum controls provision set out in the Domestic Heating Compliance Guide?	Space heating control: Time and temperature zone control - plumbing circuit Hot water control: No hot water cylinder Boiler interlock (main system 1)	Authorised SAP Assessor	Passed																		

Check	Evidence	Produced by	OK?
Fixed internal lighting			
Does fixed internal lighting comply with paragraphs 42 to 44?	Schedule of installed fixed internal lighting Standard lights = 0 Low energy lights = 10 Percentage of low energy lights = 100% Minimum = 75 %	Authorised SAP Assessor	Passed
Criterion 3: the dwelling has appropriate passive control measures to limit solar gains			
Does the dwelling have a strong tendency to high summertime temperatures?	Overheating risk (June) = Not significant (20.01°) Overheating risk (July) = Slight (21.75°) Overheating risk (August) = Slight (21.55°) Region = Thames Thermal mass parameter = 194.00 Ventilation rate in hot weather = 3.00 ach Blinds/curtains = Light-coloured curtain or roller blind	Authorised SAP Assessor	Passed
Criterion 4: the performance of the dwelling, as designed, is consistent with the DER			
Design air permeability (m ³ /h.m ² at 50Pa)	Design air permeability = 4.00 Max air permeability = 10.00	Authorised SAP Assessor	Passed
Mechanical ventilation system Specific fan power (SFP)	Mechanical extract ventilation (decentralised): each SFP must be no greater than 0.7 W/(litre/sec) In room fans (kitchen) SFP = 0.20 In room fans (non-kitchen) SFP = 0.24	Authorised SAP Assessor	Passed
Have the key features of the design been included (or bettered) in practice?	The following party walls have a U-value less than 0.2W/m ² K: • Party Wall (0.00)	Authorised SAP Assessor	

L1A 2013 - Regulations Compliance Report

Design - Draft



This design draft submission provides evidence towards compliance with Part L of the Building Regulations, in accordance with Appendix C of AD L1A. It has been carried out using Approved SAP software. It has been prepared from plans and specifications and may not reflect the 'as built' property. This report covers only items included within the SAP and is not a complete report of regulations compliance.

Assessor name	Mr Simon Gowing	Assessor number	9641
Client		Last modified	29/10/2018
Address	HA3B - END Oxford Road, Bodicaote, OX15		

Check	Evidence	Produced by	OK?																		
Criterion 1: predicted carbon dioxide emission from proposed dwelling does not exceed the target																					
TER (kg CO ₂ /m ² .a)	Fuel = N/A Fuel factor = 1.00 TER = 17.88	Authorised SAP Assessor																			
DER for dwelling as designed (kg CO ₂ /m ² .a)	DER = 15.65	Authorised SAP Assessor																			
Are emissions from dwelling as designed less than or equal to the target?	DER 15.65 < TER 17.88	Authorised SAP Assessor	Passed																		
Is the fabric energy efficiency of the dwelling as designed less than or equal to the target?	DFEE 46.8 < TFEE 52.7	Authorised SAP Assessor	Passed																		
Criterion 2: the performance of the building fabric and the heating, hot water and fixed lighting systems should be no worse than the design limits																					
Fabric U-values																					
Are all U-values better than the design limits in Table 2?	<table border="1"> <thead> <tr> <th>Element</th> <th colspan="2">Weighted average Highest</th> </tr> </thead> <tbody> <tr> <td>Wall</td> <td>0.21 (max 0.30)</td> <td>0.21 (max 0.70)</td> </tr> <tr> <td>Party wall</td> <td>0.00 (max 0.20)</td> <td>N/A</td> </tr> <tr> <td>Floor</td> <td>0.16 (max 0.25)</td> <td>0.16 (max 0.70)</td> </tr> <tr> <td>Roof</td> <td>0.11 (max 0.20)</td> <td>0.11 (max 0.35)</td> </tr> <tr> <td>Openings</td> <td>1.30 (max 2.00)</td> <td>1.30 (max 3.30)</td> </tr> </tbody> </table>	Element	Weighted average Highest		Wall	0.21 (max 0.30)	0.21 (max 0.70)	Party wall	0.00 (max 0.20)	N/A	Floor	0.16 (max 0.25)	0.16 (max 0.70)	Roof	0.11 (max 0.20)	0.11 (max 0.35)	Openings	1.30 (max 2.00)	1.30 (max 3.30)	Authorised SAP Assessor	Passed
Element	Weighted average Highest																				
Wall	0.21 (max 0.30)	0.21 (max 0.70)																			
Party wall	0.00 (max 0.20)	N/A																			
Floor	0.16 (max 0.25)	0.16 (max 0.70)																			
Roof	0.11 (max 0.20)	0.11 (max 0.35)																			
Openings	1.30 (max 2.00)	1.30 (max 3.30)																			
Thermal bridging																					
How has the loss from thermal bridges been calculated?	Thermal bridging calculated from linear thermal transmittances for each junction	Authorised SAP Assessor																			
Heating and hot water systems																					
Does the efficiency of the heating systems meet the minimum value set out in the Domestic Heating Compliance Guide?	Main heating system: Mains gas, Combi boiler from database Potterton Promax Ultra Combi 33 ErP Efficiency = 89.10% - SEDBUK 2009 Minimum = 88.00% Secondary heating system: None	Authorised SAP Assessor	Passed																		
Does the insulation of the hot water cylinder meet the standards set out in the Domestic Heating Compliance Guide?	No hot water cylinder	Authorised SAP Assessor																			
Do controls meet the minimum controls provision set out in the Domestic Heating Compliance Guide?	Space heating control: Time and temperature zone control - plumbing circuit Hot water control: No hot water cylinder Boiler interlock (main system 1)	Authorised SAP Assessor	Passed																		

Check	Evidence	Produced by	OK?
Fixed internal lighting			
Does fixed internal lighting comply with paragraphs 42 to 44?	Schedule of installed fixed internal lighting Standard lights = 0 Low energy lights = 15 Percentage of low energy lights = 100% Minimum = 75 %	Authorised SAP Assessor	Passed
Criterion 3: the dwelling has appropriate passive control measures to limit solar gains			
Does the dwelling have a strong tendency to high summertime temperatures?	Overheating risk (June) = Not significant (18.91°) Overheating risk (July) = Slight (20.68°) Overheating risk (August) = Not significant (20.48°) Region = Thames Thermal mass parameter = 250.00 Ventilation rate in hot weather = 4.00 ach Blinds/curtains = Dark-coloured curtain or roller blind	Authorised SAP Assessor	Passed
Criterion 4: the performance of the dwelling, as designed, is consistent with the DER			
Design air permeability (m ³ /h.m ² at 50Pa)	Design air permeability = 5.00 Max air permeability = 10.00	Authorised SAP Assessor	Passed
Mechanical ventilation system Specific fan power (SFP)	Not applicable	Authorised SAP Assessor	
Have the key features of the design been included (or bettered) in practice?	The following party walls have a U-value less than 0.2W/m ² K: • Party (0.00) The following roofs have a U-value less than 0.13W/m ² K: • Insulated at Joists (0.11)	Authorised SAP Assessor	

L1A 2013 - Regulations Compliance Report

Design - Draft



This design draft submission provides evidence towards compliance with Part L of the Building Regulations, in accordance with Appendix C of AD L1A. It has been carried out using Approved SAP software. It has been prepared from plans and specifications and may not reflect the 'as built' property. This report covers only items included within the SAP and is not a complete report of regulations compliance.

Assessor name	Mr Simon Gowing	Assessor number	9641
Client		Last modified	29/10/2018
Address	HALSTEAD Oxford Road, Bodicaote, OX15		

Check	Evidence	Produced by	OK?																		
Criterion 1: predicted carbon dioxide emission from proposed dwelling does not exceed the target																					
TER (kg CO ₂ /m ² .a)	Fuel = N/A Fuel factor = 1.00 TER = 15.73	Authorised SAP Assessor																			
DER for dwelling as designed (kg CO ₂ /m ² .a)	DER = 14.64	Authorised SAP Assessor																			
Are emissions from dwelling as designed less than or equal to the target?	DER 14.64 < TER 15.73	Authorised SAP Assessor	Passed																		
Is the fabric energy efficiency of the dwelling as designed less than or equal to the target?	DFEE 42.7 < TFEE 47.5	Authorised SAP Assessor	Passed																		
Criterion 2: the performance of the building fabric and the heating, hot water and fixed lighting systems should be no worse than the design limits																					
Fabric U-values																					
Are all U-values better than the design limits in Table 2?	<table border="1"> <thead> <tr> <th>Element</th> <th colspan="2">Weighted average Highest</th> </tr> </thead> <tbody> <tr> <td>Wall</td> <td>0.21 (max 0.30)</td> <td>0.21 (max 0.70)</td> </tr> <tr> <td>Party wall</td> <td>0.00 (max 0.20)</td> <td>N/A</td> </tr> <tr> <td>Floor</td> <td>0.15 (max 0.25)</td> <td>0.15 (max 0.70)</td> </tr> <tr> <td>Roof</td> <td>0.14 (max 0.20)</td> <td>0.21 (max 0.35)</td> </tr> <tr> <td>Openings</td> <td>1.30 (max 2.00)</td> <td>1.40 (max 3.30)</td> </tr> </tbody> </table>	Element	Weighted average Highest		Wall	0.21 (max 0.30)	0.21 (max 0.70)	Party wall	0.00 (max 0.20)	N/A	Floor	0.15 (max 0.25)	0.15 (max 0.70)	Roof	0.14 (max 0.20)	0.21 (max 0.35)	Openings	1.30 (max 2.00)	1.40 (max 3.30)	Authorised SAP Assessor	Passed
Element	Weighted average Highest																				
Wall	0.21 (max 0.30)	0.21 (max 0.70)																			
Party wall	0.00 (max 0.20)	N/A																			
Floor	0.15 (max 0.25)	0.15 (max 0.70)																			
Roof	0.14 (max 0.20)	0.21 (max 0.35)																			
Openings	1.30 (max 2.00)	1.40 (max 3.30)																			
Thermal bridging																					
How has the loss from thermal bridges been calculated?	Thermal bridging calculated from linear thermal transmittances for each junction	Authorised SAP Assessor																			
Heating and hot water systems																					
Does the efficiency of the heating systems meet the minimum value set out in the Domestic Heating Compliance Guide?	Main heating system: Mains gas, Regular boiler from database Potterton Promax 24 System ErP Efficiency = 89.00% - SEDBUK 2009 Minimum = 88.00% Secondary heating system: None	Authorised SAP Assessor	Passed																		
Does the insulation of the hot water cylinder meet the standards set out in the Domestic Heating Compliance Guide?	Cylinder volume = 250.00 litres Declared cylinder loss = 1.67kWh/day Maximum permitted cylinder loss = 2.56kWh/day Primary hot water pipes are insulated	Authorised SAP Assessor	Passed																		
Do controls meet the minimum controls provision set out in the Domestic Heating Compliance Guide?	Space heating control: Time and temperature zone control - plumbing circuit Hot water control: Boiler interlock (main system 1) Cylinder thermostat Separate water control	Authorised SAP Assessor	Passed																		

Check	Evidence	Produced by	OK?
Fixed internal lighting			
Does fixed internal lighting comply with paragraphs 42 to 44?	Schedule of installed fixed internal lighting Standard lights = 0 Low energy lights = 15 Percentage of low energy lights = 100% Minimum = 75 %	Authorised SAP Assessor	Passed
Criterion 3: the dwelling has appropriate passive control measures to limit solar gains			
Does the dwelling have a strong tendency to high summertime temperatures?	Overheating risk (June) = Not significant (18.87°) Overheating risk (July) = Slight (20.65°) Overheating risk (August) = Not significant (20.43°) Region = Thames Thermal mass parameter = 250.00 Ventilation rate in hot weather = 4.00 ach Blinds/curtains = Dark-coloured curtain or roller blind	Authorised SAP Assessor	Passed
Criterion 4: the performance of the dwelling, as designed, is consistent with the DER			
Design air permeability (m ³ /h.m ² at 50Pa)	Design air permeability = 5.00 Max air permeability = 10.00	Authorised SAP Assessor	Passed
Mechanical ventilation system Specific fan power (SFP)	Not applicable	Authorised SAP Assessor	
Have the key features of the design been included (or bettered) in practice?	The following party walls have a U-value less than 0.2W/m ² K: • Party (0.00) The following roofs have a U-value less than 0.13W/m ² K: • Insulated at rafters (0.12) • 1st to Void (0.12)	Authorised SAP Assessor	

L1A 2013 - Regulations Compliance Report

Design - Draft



This design draft submission provides evidence towards compliance with Part L of the Building Regulations, in accordance with Appendix C of AD L1A. It has been carried out using Approved SAP software. It has been prepared from plans and specifications and may not reflect the 'as built' property. This report covers only items included within the SAP and is not a complete report of regulations compliance.

Assessor name	Mr Simon Gowing	Assessor number	9641
Client		Last modified	29/10/2018
Address	HARTLEY Oxford Road, Bodicaote, OX15		

Check	Evidence	Produced by	OK?																		
Criterion 1: predicted carbon dioxide emission from proposed dwelling does not exceed the target																					
TER (kg CO ₂ /m ² .a)	Fuel = N/A Fuel factor = 1.00 TER = 17.41	Authorised SAP Assessor																			
DER for dwelling as designed (kg CO ₂ /m ² .a)	DER = 15.15	Authorised SAP Assessor																			
Are emissions from dwelling as designed less than or equal to the target?	DER 15.15 < TER 17.41	Authorised SAP Assessor	Passed																		
Is the fabric energy efficiency of the dwelling as designed less than or equal to the target?	DFEE 44.1 < TFEE 50.6	Authorised SAP Assessor	Passed																		
Criterion 2: the performance of the building fabric and the heating, hot water and fixed lighting systems should be no worse than the design limits																					
Fabric U-values																					
Are all U-values better than the design limits in Table 2?	<table border="1"> <thead> <tr> <th>Element</th> <th colspan="2">Weighted average Highest</th> </tr> </thead> <tbody> <tr> <td>Wall</td> <td>0.21 (max 0.30)</td> <td>0.21 (max 0.70)</td> </tr> <tr> <td>Party wall</td> <td>0.00 (max 0.20)</td> <td>N/A</td> </tr> <tr> <td>Floor</td> <td>0.15 (max 0.25)</td> <td>0.15 (max 0.70)</td> </tr> <tr> <td>Roof</td> <td>0.11 (max 0.20)</td> <td>0.11 (max 0.35)</td> </tr> <tr> <td>Openings</td> <td>1.30 (max 2.00)</td> <td>1.30 (max 3.30)</td> </tr> </tbody> </table>	Element	Weighted average Highest		Wall	0.21 (max 0.30)	0.21 (max 0.70)	Party wall	0.00 (max 0.20)	N/A	Floor	0.15 (max 0.25)	0.15 (max 0.70)	Roof	0.11 (max 0.20)	0.11 (max 0.35)	Openings	1.30 (max 2.00)	1.30 (max 3.30)	Authorised SAP Assessor	Passed
Element	Weighted average Highest																				
Wall	0.21 (max 0.30)	0.21 (max 0.70)																			
Party wall	0.00 (max 0.20)	N/A																			
Floor	0.15 (max 0.25)	0.15 (max 0.70)																			
Roof	0.11 (max 0.20)	0.11 (max 0.35)																			
Openings	1.30 (max 2.00)	1.30 (max 3.30)																			
Thermal bridging																					
How has the loss from thermal bridges been calculated?	Thermal bridging calculated from linear thermal transmittances for each junction	Authorised SAP Assessor																			
Heating and hot water systems																					
Does the efficiency of the heating systems meet the minimum value set out in the Domestic Heating Compliance Guide?	Main heating system: Mains gas, Combi boiler from database Potterton Promax Ultra Combi 40 ErP Efficiency = 89.10% - SEDBUK 2009 Minimum = 88.00% Secondary heating system: None	Authorised SAP Assessor	Passed																		
Does the insulation of the hot water cylinder meet the standards set out in the Domestic Heating Compliance Guide?	No hot water cylinder	Authorised SAP Assessor																			
Do controls meet the minimum controls provision set out in the Domestic Heating Compliance Guide?	Space heating control: Time and temperature zone control - plumbing circuit Hot water control: No hot water cylinder Boiler interlock (main system 1)	Authorised SAP Assessor	Passed																		

Check	Evidence	Produced by	OK?
Fixed internal lighting			
Does fixed internal lighting comply with paragraphs 42 to 44?	Schedule of installed fixed internal lighting Standard lights = 0 Low energy lights = 15 Percentage of low energy lights = 100% Minimum = 75 %	Authorised SAP Assessor	Passed
Criterion 3: the dwelling has appropriate passive control measures to limit solar gains			
Does the dwelling have a strong tendency to high summertime temperatures?	Overheating risk (June) = Not significant (19.05°) Overheating risk (July) = Slight (20.81°) Overheating risk (August) = Slight (20.56°) Region = Thames Thermal mass parameter = 250.00 Ventilation rate in hot weather = 4.00 ach Blinds/curtains = Dark-coloured curtain or roller blind	Authorised SAP Assessor	Passed
Criterion 4: the performance of the dwelling, as designed, is consistent with the DER			
Design air permeability (m ³ /h.m ² at 50Pa)	Design air permeability = 5.00 Max air permeability = 10.00	Authorised SAP Assessor	Passed
Mechanical ventilation system Specific fan power (SFP)	Not applicable	Authorised SAP Assessor	
Have the key features of the design been included (or bettered) in practice?	The following party walls have a U-value less than 0.2W/m ² K: • Party (0.00) The following roofs have a U-value less than 0.13W/m ² K: • Insulated at Joists (0.11)	Authorised SAP Assessor	

L1A 2013 - Regulations Compliance Report

Design - Draft



This design draft submission provides evidence towards compliance with Part L of the Building Regulations, in accordance with Appendix C of AD L1A. It has been carried out using Approved SAP software. It has been prepared from plans and specifications and may not reflect the 'as built' property. This report covers only items included within the SAP and is not a complete report of regulations compliance.

Assessor name	Mr Simon Gowing	Assessor number	9641
Client		Last modified	29/10/2018
Address	LANGFORD Oxford Road, Bodicaote, OX15		

Check	Evidence	Produced by	OK?
Criterion 1: predicted carbon dioxide emission from proposed dwelling does not exceed the target			
TER (kg CO ₂ /m ² .a)	Fuel = N/A Fuel factor = 1.00 TER = 17.92	Authorised SAP Assessor	
DER for dwelling as designed (kg CO ₂ /m ² .a)	DER = 16.34	Authorised SAP Assessor	
Are emissions from dwelling as designed less than or equal to the target?	DER 16.34 < TER 17.92	Authorised SAP Assessor	Passed
Is the fabric energy efficiency of the dwelling as designed less than or equal to the target?	DFEE 49.1 < TFEE 56.3	Authorised SAP Assessor	Passed

Criterion 2: the performance of the building fabric and the heating, hot water and fixed lighting systems should be no worse than the design limits

Fabric U-values

Are all U-values better than the design limits in Table 2?	Element	Weighted average Highest		Produced by	OK?
	Wall	0.21 (max 0.30)	0.21 (max 0.70)	Authorised SAP Assessor	Passed
	Party wall	(no party wall)			
	Floor	0.15 (max 0.25)	0.15 (max 0.70)		
	Roof	0.11 (max 0.20)	0.11 (max 0.35)		
	Openings	1.30 (max 2.00)	1.30 (max 3.30)		

Thermal bridging

How has the loss from thermal bridges been calculated?	Thermal bridging calculated from linear thermal transmittances for each junction	Authorised SAP Assessor	
--	--	-------------------------	--

Heating and hot water systems

Does the efficiency of the heating systems meet the minimum value set out in the Domestic Heating Compliance Guide?	Main heating system: Mains gas, Regular boiler from database Potterton Promax 24 System ErP Efficiency = 89.00% - SEDBUK 2009 Minimum = 88.00%	Authorised SAP Assessor	Passed
	Secondary heating system: None		
Does the insulation of the hot water cylinder meet the standards set out in the Domestic Heating Compliance Guide?	Cylinder volume = 250.00 litres Declared cylinder loss = 1.67kWh/day Maximum permitted cylinder loss = 2.56kWh/day Primary hot water pipes are insulated	Authorised SAP Assessor	Passed
Do controls meet the minimum controls provision set out in the Domestic Heating Compliance Guide?	Space heating control: Time and temperature zone control - plumbing circuit Hot water control: Boiler interlock (main system 1) Cylinder thermostat Separate water control	Authorised SAP Assessor	Passed

Check	Evidence	Produced by	OK?
Fixed internal lighting			
Does fixed internal lighting comply with paragraphs 42 to 44?	Schedule of installed fixed internal lighting Standard lights = 0 Low energy lights = 26 Percentage of low energy lights = 100% Minimum = 75 %	Authorised SAP Assessor	Passed
Criterion 3: the dwelling has appropriate passive control measures to limit solar gains			
Does the dwelling have a strong tendency to high summertime temperatures?	Overheating risk (June) = Not significant (19.09°) Overheating risk (July) = Slight (20.88°) Overheating risk (August) = Slight (20.69°) Region = Thames Thermal mass parameter = 191.00 Ventilation rate in hot weather = 4.00 ach Blinds/curtains = Dark-coloured curtain or roller blind	Authorised SAP Assessor	Passed
Criterion 4: the performance of the dwelling, as designed, is consistent with the DER			
Design air permeability (m ³ /h.m ² at 50Pa)	Design air permeability = 5.00 Max air permeability = 10.00	Authorised SAP Assessor	Passed
Mechanical ventilation system Specific fan power (SFP)	Not applicable	Authorised SAP Assessor	
Have the key features of the design been included (or bettered) in practice?	The following roofs have a U-value less than 0.13W/m ² K: • 400mm Mineral wool (0.11) Thermal bridging γ value (0.034) is less than 0.04	Authorised SAP Assessor	

L1A 2013 - Regulations Compliance Report

Design - Draft



This design draft submission provides evidence towards compliance with Part L of the Building Regulations, in accordance with Appendix C of AD L1A. It has been carried out using Approved SAP software. It has been prepared from plans and specifications and may not reflect the 'as built' property. This report covers only items included within the SAP and is not a complete report of regulations compliance.

Assessor name	Mr Simon Gowing	Assessor number	9641
Client		Last modified	29/10/2018
Address	RADLEY Oxford Road, Bodicaote, OX15		

Check	Evidence	Produced by	OK?
Criterion 1: predicted carbon dioxide emission from proposed dwelling does not exceed the target			
TER (kg CO ₂ /m ² .a)	Fuel = N/A Fuel factor = 1.00 TER = 17.27	Authorised SAP Assessor	
DER for dwelling as designed (kg CO ₂ /m ² .a)	DER = 16.03	Authorised SAP Assessor	
Are emissions from dwelling as designed less than or equal to the target?	DER 16.03 < TER 17.27	Authorised SAP Assessor	Passed
Is the fabric energy efficiency of the dwelling as designed less than or equal to the target?	DFEE 54.7 < TFEE 63.2	Authorised SAP Assessor	Passed

Criterion 2: the performance of the building fabric and the heating, hot water and fixed lighting systems should be no worse than the design limits

Fabric U-values

Are all U-values better than the design limits in Table 2?	Element	Weighted average Highest		Produced by	OK?
	Wall	0.21 (max 0.30)	0.21 (max 0.70)	Authorised SAP Assessor	Passed
	Party wall	(no party wall)			
	Floor	0.15 (max 0.25)	0.15 (max 0.70)		
	Roof	0.11 (max 0.20)	0.21 (max 0.35)		
	Openings	1.30 (max 2.00)	1.30 (max 3.30)		

Thermal bridging

How has the loss from thermal bridges been calculated?	Thermal bridging calculated from linear thermal transmittances for each junction	Authorised SAP Assessor	
--	--	-------------------------	--

Heating and hot water systems

Does the efficiency of the heating systems meet the minimum value set out in the Domestic Heating Compliance Guide?	Main heating system: Mains gas, Regular boiler from database Potterton Promax 24 System ErP Efficiency = 89.00% - SEDBUK 2009 Minimum = 88.00% Secondary heating system: None	Authorised SAP Assessor	Passed
Does the insulation of the hot water cylinder meet the standards set out in the Domestic Heating Compliance Guide?	Cylinder volume = 250.00 litres Declared cylinder loss = 1.67kWh/day Maximum permitted cylinder loss = 2.56kWh/day Primary hot water pipes are insulated	Authorised SAP Assessor	Passed
Do controls meet the minimum controls provision set out in the Domestic Heating Compliance Guide?	Space heating control: Time and temperature zone control - plumbing circuit Hot water control: Boiler interlock (main system 1) Cylinder thermostat Separate water control	Authorised SAP Assessor	Passed

Check	Evidence	Produced by	OK?
Fixed internal lighting			
Does fixed internal lighting comply with paragraphs 42 to 44?	Schedule of installed fixed internal lighting Standard lights = 0 Low energy lights = 26 Percentage of low energy lights = 100% Minimum = 75 %	Authorised SAP Assessor	Passed
Criterion 3: the dwelling has appropriate passive control measures to limit solar gains			
Does the dwelling have a strong tendency to high summertime temperatures?	Overheating risk (June) = Not significant (19.02°) Overheating risk (July) = Slight (20.78°) Overheating risk (August) = Not significant (20.47°) Region = Thames Thermal mass parameter = 191.00 Ventilation rate in hot weather = 4.00 ach Blinds/curtains = Dark-coloured curtain or roller blind	Authorised SAP Assessor	Passed
Criterion 4: the performance of the dwelling, as designed, is consistent with the DER			
Design air permeability (m ³ /h.m ² at 50Pa)	Design air permeability = 5.00 Max air permeability = 10.00	Authorised SAP Assessor	Passed
Mechanical ventilation system Specific fan power (SFP)	Not applicable	Authorised SAP Assessor	
Have the key features of the design been included (or bettered) in practice?	The following roofs have a U-value less than 0.13W/m ² K: • 400mm Mineral wool (0.11)	Authorised SAP Assessor	

L1A 2013 - Regulations Compliance Report

Design - Draft



This design draft submission provides evidence towards compliance with Part L of the Building Regulations, in accordance with Appendix C of AD L1A. It has been carried out using Approved SAP software. It has been prepared from plans and specifications and may not reflect the 'as built' property. This report covers only items included within the SAP and is not a complete report of regulations compliance.

Assessor name	Mr Simon Gowing	Assessor number	9641
Client		Last modified	29/10/2018
Address	SOMERTON Oxford Road, Bodicaote, OX15		

Check	Evidence	Produced by	OK?
Criterion 1: predicted carbon dioxide emission from proposed dwelling does not exceed the target			
TER (kg CO ₂ /m ² .a)	Fuel = N/A Fuel factor = 1.00 TER = 16.42	Authorised SAP Assessor	
DER for dwelling as designed (kg CO ₂ /m ² .a)	DER = 15.23	Authorised SAP Assessor	
Are emissions from dwelling as designed less than or equal to the target?	DER 15.23 < TER 16.42	Authorised SAP Assessor	Passed
Is the fabric energy efficiency of the dwelling as designed less than or equal to the target?	DFEE 51.3 < TFEE 58.2	Authorised SAP Assessor	Passed

Criterion 2: the performance of the building fabric and the heating, hot water and fixed lighting systems should be no worse than the design limits

Fabric U-values

Are all U-values better than the design limits in Table 2?	Element	Weighted average Highest		Produced by	OK?
	Wall	0.21 (max 0.30)	0.21 (max 0.70)	Authorised SAP Assessor	Passed
	Party wall	(no party wall)			
	Floor	0.15 (max 0.25)	0.15 (max 0.70)		
	Roof	0.12 (max 0.20)	0.21 (max 0.35)		
	Openings	1.30 (max 2.00)	1.30 (max 3.30)		

Thermal bridging

How has the loss from thermal bridges been calculated?	Thermal bridging calculated from linear thermal transmittances for each junction	Authorised SAP Assessor	
--	--	-------------------------	--

Heating and hot water systems

Does the efficiency of the heating systems meet the minimum value set out in the Domestic Heating Compliance Guide?	Main heating system: Mains gas, Regular boiler from database Potterton Promax 24 System ErP Efficiency = 89.00% - SEDBUK 2009 Minimum = 88.00% Secondary heating system: None	Authorised SAP Assessor	Passed
Does the insulation of the hot water cylinder meet the standards set out in the Domestic Heating Compliance Guide?	Cylinder volume = 250.00 litres Declared cylinder loss = 1.67kWh/day Maximum permitted cylinder loss = 2.56kWh/day Primary hot water pipes are insulated	Authorised SAP Assessor	Passed
Do controls meet the minimum controls provision set out in the Domestic Heating Compliance Guide?	Space heating control: Time and temperature zone control - plumbing circuit Hot water control: Boiler interlock (main system 1) Cylinder thermostat Separate water control	Authorised SAP Assessor	Passed

Check	Evidence	Produced by	OK?
Fixed internal lighting			
Does fixed internal lighting comply with paragraphs 42 to 44?	Schedule of installed fixed internal lighting Standard lights = 0 Low energy lights = 26 Percentage of low energy lights = 100% Minimum = 75 %	Authorised SAP Assessor	Passed
Criterion 3: the dwelling has appropriate passive control measures to limit solar gains			
Does the dwelling have a strong tendency to high summertime temperatures?	Overheating risk (June) = Not significant (19.82°) Overheating risk (July) = Slight (21.56°) Overheating risk (August) = Slight (21.27°) Region = Thames Thermal mass parameter = 191.00 Ventilation rate in hot weather = 4.00 ach Blinds/curtains = Dark-coloured curtain or roller blind	Authorised SAP Assessor	Passed
Criterion 4: the performance of the dwelling, as designed, is consistent with the DER			
Design air permeability (m ³ /h.m ² at 50Pa)	Design air permeability = 5.00 Max air permeability = 10.00	Authorised SAP Assessor	Passed
Mechanical ventilation system Specific fan power (SFP)	Not applicable	Authorised SAP Assessor	
Have the key features of the design been included (or bettered) in practice?	The following roofs have a U-value less than 0.13W/m ² K: • 400mm Mineral wool (0.11) Thermal bridging γ value (0.034) is less than 0.04	Authorised SAP Assessor	

L1A 2013 - Regulations Compliance Report

Design - Draft



This design draft submission provides evidence towards compliance with Part L of the Building Regulations, in accordance with Appendix C of AD L1A. It has been carried out using Approved SAP software. It has been prepared from plans and specifications and may not reflect the 'as built' property. This report covers only items included within the SAP and is not a complete report of regulations compliance.

Assessor name	Mr Simon Gowing	Assessor number	9641
Client		Last modified	29/10/2018
Address	TF 1B Oxford Road, Bodicaote, OX15		

Check	Evidence	Produced by	OK?																		
Criterion 1: predicted carbon dioxide emission from proposed dwelling does not exceed the target																					
TER (kg CO ₂ /m ² .a)	Fuel = N/A Fuel factor = 1.00 TER = 19.99	Authorised SAP Assessor																			
DER for dwelling as designed (kg CO ₂ /m ² .a)	DER = 16.28	Authorised SAP Assessor																			
Are emissions from dwelling as designed less than or equal to the target?	DER 16.28 < TER 19.99	Authorised SAP Assessor	Passed																		
Is the fabric energy efficiency of the dwelling as designed less than or equal to the target?	DFEE 40.8 < TFEE 49.1	Authorised SAP Assessor	Passed																		
Criterion 2: the performance of the building fabric and the heating, hot water and fixed lighting systems should be no worse than the design limits																					
Fabric U-values																					
Are all U-values better than the design limits in Table 2?	<table border="1"> <thead> <tr> <th>Element</th> <th colspan="2">Weighted average Highest</th> </tr> </thead> <tbody> <tr> <td>Wall</td> <td>0.20 (max 0.30)</td> <td>0.20 (max 0.70)</td> </tr> <tr> <td>Party wall</td> <td>0.00 (max 0.20)</td> <td>N/A</td> </tr> <tr> <td>Floor</td> <td>0.19 (max 0.25)</td> <td>0.19 (max 0.70)</td> </tr> <tr> <td>Roof</td> <td>0.11 (max 0.20)</td> <td>0.11 (max 0.35)</td> </tr> <tr> <td>Openings</td> <td>1.30 (max 2.00)</td> <td>1.30 (max 3.30)</td> </tr> </tbody> </table>	Element	Weighted average Highest		Wall	0.20 (max 0.30)	0.20 (max 0.70)	Party wall	0.00 (max 0.20)	N/A	Floor	0.19 (max 0.25)	0.19 (max 0.70)	Roof	0.11 (max 0.20)	0.11 (max 0.35)	Openings	1.30 (max 2.00)	1.30 (max 3.30)	Authorised SAP Assessor	Passed
Element	Weighted average Highest																				
Wall	0.20 (max 0.30)	0.20 (max 0.70)																			
Party wall	0.00 (max 0.20)	N/A																			
Floor	0.19 (max 0.25)	0.19 (max 0.70)																			
Roof	0.11 (max 0.20)	0.11 (max 0.35)																			
Openings	1.30 (max 2.00)	1.30 (max 3.30)																			
Thermal bridging																					
How has the loss from thermal bridges been calculated?	Thermal bridging calculated from linear thermal transmittances for each junction	Authorised SAP Assessor																			
Heating and hot water systems																					
Does the efficiency of the heating systems meet the minimum value set out in the Domestic Heating Compliance Guide?	Main heating system: Mains gas, Combi boiler from database Potterton Promax Ultra Combi 28 ErP Efficiency = 89.10% - SEDBUK 2009 Minimum = 88.00% Secondary heating system: None	Authorised SAP Assessor	Passed																		
Does the insulation of the hot water cylinder meet the standards set out in the Domestic Heating Compliance Guide?	No hot water cylinder	Authorised SAP Assessor																			
Do controls meet the minimum controls provision set out in the Domestic Heating Compliance Guide?	Space heating control: Time and temperature zone control - plumbing circuit Hot water control: No hot water cylinder Boiler interlock (main system 1)	Authorised SAP Assessor	Passed																		

Check	Evidence	Produced by	OK?
Fixed internal lighting			
Does fixed internal lighting comply with paragraphs 42 to 44?	Schedule of installed fixed internal lighting Standard lights = 0 Low energy lights = 10 Percentage of low energy lights = 100% Minimum = 75 %	Authorised SAP Assessor	Passed
Criterion 3: the dwelling has appropriate passive control measures to limit solar gains			
Does the dwelling have a strong tendency to high summertime temperatures?	Overheating risk (June) = Not significant (18.98°) Overheating risk (July) = Slight (20.78°) Overheating risk (August) = Slight (20.65°) Region = Thames Thermal mass parameter = 185.00 Ventilation rate in hot weather = 4.00 ach Blinds/curtains = Light-coloured curtain or roller blind	Authorised SAP Assessor	Passed
Criterion 4: the performance of the dwelling, as designed, is consistent with the DER			
Design air permeability (m ³ /h.m ² at 50Pa)	Design air permeability = 4.00 Max air permeability = 10.00	Authorised SAP Assessor	Passed
Mechanical ventilation system Specific fan power (SFP)	Mechanical extract ventilation (decentralised): each SFP must be no greater than 0.7 W/(litre/sec) In room fans (kitchen) SFP = 0.20 In room fans (non-kitchen) SFP = 0.24	Authorised SAP Assessor	Passed
Have the key features of the design been included (or bettered) in practice?	The following party walls have a U-value less than 0.2W/m ² K: • Party Wall Down (0.00) • Party Wall Up (0.00) The following roofs have a U-value less than 0.13W/m ² K: • Cold Roof (pitched) (0.11)	Authorised SAP Assessor	

L1A 2013 - Regulations Compliance Report

Design - Draft



This design draft submission provides evidence towards compliance with Part L of the Building Regulations, in accordance with Appendix C of AD L1A. It has been carried out using Approved SAP software. It has been prepared from plans and specifications and may not reflect the 'as built' property. This report covers only items included within the SAP and is not a complete report of regulations compliance.

Assessor name	Mr Simon Gowing	Assessor number	9641
Client		Last modified	29/10/2018
Address	TINDALL Oxford Road, Bodicaote, OX15		

Check	Evidence	Produced by	OK?
Criterion 1: predicted carbon dioxide emission from proposed dwelling does not exceed the target			
TER (kg CO ₂ /m ² .a)	Fuel = N/A Fuel factor = 1.00 TER = 13.86	Authorised SAP Assessor	
DER for dwelling as designed (kg CO ₂ /m ² .a)	DER = 12.81	Authorised SAP Assessor	
Are emissions from dwelling as designed less than or equal to the target?	DER 12.81 < TER 13.86	Authorised SAP Assessor	Passed
Is the fabric energy efficiency of the dwelling as designed less than or equal to the target?	DFEE 45.0 < TFEE 51.7	Authorised SAP Assessor	Passed

Criterion 2: the performance of the building fabric and the heating, hot water and fixed lighting systems should be no worse than the design limits

Fabric U-values

Are all U-values better than the design limits in Table 2?	Element	Weighted average Highest		Produced by	OK?
	Wall	0.21 (max 0.30)	0.21 (max 0.70)	Authorised SAP Assessor	Passed
	Party wall	(no party wall)			
	Floor	0.15 (max 0.25)	0.15 (max 0.70)		
	Roof	0.11 (max 0.20)	0.11 (max 0.35)		
	Openings	1.30 (max 2.00)	1.30 (max 3.30)		

Thermal bridging

How has the loss from thermal bridges been calculated?	Thermal bridging calculated from linear thermal transmittances for each junction	Authorised SAP Assessor	
--	--	-------------------------	--

Heating and hot water systems

Does the efficiency of the heating systems meet the minimum value set out in the Domestic Heating Compliance Guide?	Main heating system: Mains gas, Regular boiler from database Potterton Promax 24 System ErP Efficiency = 89.00% - SEDBUK 2009 Minimum = 88.00%	Authorised SAP Assessor	Passed
	Secondary heating system: None		
Does the insulation of the hot water cylinder meet the standards set out in the Domestic Heating Compliance Guide?	Cylinder volume = 250.00 litres Declared cylinder loss = 1.67kWh/day Maximum permitted cylinder loss = 2.56kWh/day Primary hot water pipes are insulated	Authorised SAP Assessor	Passed
Do controls meet the minimum controls provision set out in the Domestic Heating Compliance Guide?	Space heating control: Time and temperature zone control - plumbing circuit Hot water control: Boiler interlock (main system 1) Cylinder thermostat Separate water control	Authorised SAP Assessor	Passed

Check	Evidence	Produced by	OK?
Fixed internal lighting			
Does fixed internal lighting comply with paragraphs 42 to 44?	Schedule of installed fixed internal lighting Standard lights = 0 Low energy lights = 26 Percentage of low energy lights = 100% Minimum = 75 %	Authorised SAP Assessor	Passed
Criterion 3: the dwelling has appropriate passive control measures to limit solar gains			
Does the dwelling have a strong tendency to high summertime temperatures?	Overheating risk (June) = Not significant (20.09°) Overheating risk (July) = Slight (21.83°) Overheating risk (August) = Slight (21.6°) Region = Thames Thermal mass parameter = 191.00 Ventilation rate in hot weather = 4.00 ach Blinds/curtains = Dark-coloured curtain or roller blind	Authorised SAP Assessor	Passed
Criterion 4: the performance of the dwelling, as designed, is consistent with the DER			
Design air permeability (m ³ /h.m ²) at 50Pa)	Design air permeability = 5.00 Max air permeability = 10.00	Authorised SAP Assessor	Passed
Mechanical ventilation system Specific fan power (SFP)	Not applicable	Authorised SAP Assessor	
Have the key features of the design been included (or bettered) in practice?	The following roofs have a U-value less than 0.13W/m ² K: • 400mm Mineral wool (0.11)	Authorised SAP Assessor	

Appendix D

Dwelling Emission Rate (DER) Worksheets

DER Worksheet

Design - Draft



This design submission has been carried out using Approved SAP software. It has been prepared from plans and specifications and may not reflect the property as constructed.

Assessor name	Mr Simon Gowing	Assessor number	9641
Client		Last modified	29/10/2018
Address	ADDERBURY Oxford Road, Bodicaote, OX15		

1. Overall dwelling dimensions

	Area (m ²)	Average storey height (m)	Volume (m ³)
Lowest occupied +1	57.64 (1a) x 2.38 (2a) =		137.18 (3a)
Total floor area	57.16 (1b) x 2.61 (2b) =		149.19 (3b)
Dwelling volume	(1a) + (1b) + (1c) + (1d)...(1n) =	(3a) + (3b) + (3c) + (3d)...(3n) =	114.80 (4) 286.37 (5)

2. Ventilation rate

		m ³ per hour
Number of chimneys	0 x 40 =	0 (6a)
Number of open flues	0 x 20 =	0 (6b)
Number of intermittent fans	5 x 10 =	50 (7a)
Number of passive vents	0 x 10 =	0 (7b)
Number of flueless gas fires	0 x 40 =	0 (7c)

Air changes per hour
 Infiltration due to chimneys, flues, fans, PSVs (6a) + (6b) + (7a) + (7b) + (7c) = 50 ÷ (5) = 0.17 (8)

If a pressurisation test has been carried out or is intended, proceed to (17), otherwise continue from (9) to (16)

Air permeability value, q50, expressed in cubic metres per hour per square metre of envelope area	5.00 (17)
If based on air permeability value, then (18) = [(17) ÷ 20] + (8), otherwise (18) = (16)	0.42 (18)
Number of sides on which the dwelling is sheltered	1 (19)
Shelter factor	1 - [0.075 x (19)] = 0.93 (20)
Infiltration rate incorporating shelter factor	(18) x (20) = 0.39 (21)

Infiltration rate modified for monthly wind speed:

Jan	Feb	Mar	Apr	May	Jun	Jul	Aug	Sep	Oct	Nov	Dec
5.10	5.00	4.90	4.40	4.30	3.80	3.80	3.70	4.00	4.30	4.50	4.70

Monthly average wind speed from Table U2 (22)

Wind factor (22)m ÷ 4

1.28	1.25	1.23	1.10	1.08	0.95	0.95	0.93	1.00	1.08	1.13	1.18
------	------	------	------	------	------	------	------	------	------	------	------

(22a)

Adjusted infiltration rate (allowing for shelter and wind factor) (21) x (22a)m

0.50	0.49	0.48	0.43	0.42	0.37	0.37	0.36	0.39	0.42	0.44	0.46
------	------	------	------	------	------	------	------	------	------	------	------

(22b)

Calculate effective air change rate for the applicable case:

If mechanical ventilation: air change rate through system N/A (23a)

If balanced with heat recovery: efficiency in % allowing for in-use factor from Table 4h N/A (23c)

d) natural ventilation or whole house positive input ventilation from loft

0.63	0.62	0.62	0.59	0.59	0.57	0.57	0.57	0.58	0.59	0.60	0.61
------	------	------	------	------	------	------	------	------	------	------	------

(24d)

Effective air change rate - enter (24a) or (24b) or (24c) or (24d) in (25)

0.63	0.62	0.62	0.59	0.59	0.57	0.57	0.57	0.58	0.59	0.60	0.61
------	------	------	------	------	------	------	------	------	------	------	------

(25)

3. Heat losses and heat loss parameter

Element	Gross area, m ²	Openings m ²	Net area A, m ²	U-value W/m ² K	A x U W/K	k-value, kJ/m ² .K	A x k, kJ/K
Window			28.59	1.24	35.33		
Door			2.03	1.30	2.64		
Ground floor			57.64	0.15	8.65		
External wall			124.15	0.21	26.07		
Roof			57.16	0.11	6.29		
Roof			0.47	0.21	0.10		
Total area of external elements ΣA, m ²			270.04				
Fabric heat loss, W/K = Σ(A x U)							79.07 (33)
Heat capacity Cm = Σ(A x k)							N/A (34)
Thermal mass parameter (TMP) in kJ/m ² K							191.00 (35)
Thermal bridges: Σ(L x Ψ) calculated using Appendix K							13.80 (36)
Total fabric heat loss							92.87 (37)

Total fabric heat loss (33) + (36) = 92.87 (37)

Ventilation heat loss calculated monthly 0.33 x (25)m x (5)

Jan	Feb	Mar	Apr	May	Jun	Jul	Aug	Sep	Oct	Nov	Dec
59.10	58.64	58.19	56.07	55.67	53.83	53.83	53.49	54.54	55.67	56.48	57.31

(38)

Heat transfer coefficient, W/K (37)m + (38)m

Jan	Feb	Mar	Apr	May	Jun	Jul	Aug	Sep	Oct	Nov	Dec
151.97	151.51	151.06	148.94	148.54	146.70	146.70	146.36	147.41	148.54	149.35	150.18

Average = Σ(39)1...12/12 = 148.94 (39)

Heat loss parameter (HLP), W/m²K (39)m ÷ (4)

Jan	Feb	Mar	Apr	May	Jun	Jul	Aug	Sep	Oct	Nov	Dec
1.32	1.32	1.32	1.30	1.29	1.28	1.28	1.27	1.28	1.29	1.30	1.31

Average = Σ(40)1...12/12 = 1.30 (40)

Number of days in month (Table 1a)

Jan	Feb	Mar	Apr	May	Jun	Jul	Aug	Sep	Oct	Nov	Dec
31.00	28.00	31.00	30.00	31.00	30.00	31.00	31.00	30.00	31.00	30.00	31.00

(40)

4. Water heating energy requirement

Assumed occupancy, N 2.84 (42)

Annual average hot water usage in litres per day Vd,average = (25 x N) + 36 101.67 (43)

Jan	Feb	Mar	Apr	May	Jun	Jul	Aug	Sep	Oct	Nov	Dec
111.84	107.77	103.70	99.63	95.57	91.50	91.50	95.57	99.63	103.70	107.77	111.84

Hot water usage in litres per day for each month Vd,m = factor from Table 1c x (43)

Σ(44)1...12 = 1220.02 (44)

Energy content of hot water used = 4.18 x Vd,m x nm x Tm/3600 kWh/month (see Tables 1b, 1c 1d)

Jan	Feb	Mar	Apr	May	Jun	Jul	Aug	Sep	Oct	Nov	Dec
165.85	145.05	149.68	130.50	125.21	108.05	100.12	114.89	116.27	135.50	147.90	160.62

Σ(45)1...12 = 1599.64 (45)

Distribution loss 0.15 x (45)m

Jan	Feb	Mar	Apr	May	Jun	Jul	Aug	Sep	Oct	Nov	Dec
24.88	21.76	22.45	19.57	18.78	16.21	15.02	17.23	17.44	20.32	22.19	24.09

(46)

Storage volume (litres) including any solar or WWHRs storage within same vessel 250.00 (47)

Water storage loss:

a) If manufacturer's declared loss factor is known (kWh/day) 1.67 (48)

Temperature factor from Table 2b 0.54 (49)

Energy lost from water storage (kWh/day) (48) x (49) 0.90 (50)

Enter (50) or (54) in (55) 0.90 (55)

Water storage loss calculated for each month (55) x (41)m

Jan	Feb	Mar	Apr	May	Jun	Jul	Aug	Sep	Oct	Nov	Dec
27.96	25.25	27.96	27.05	27.96	27.05	27.96	27.96	27.05	27.96	27.05	27.96

(56)

If the vessel contains dedicated solar storage or dedicated WWHRs (56)m x [(47) - Vs] ÷ (47), else (56)

27.96	25.25	27.96	27.05	27.96	27.05	27.96	27.96	27.05	27.96	27.05	27.96	(57)
-------	-------	-------	-------	-------	-------	-------	-------	-------	-------	-------	-------	------

Primary circuit loss for each month from Table 3

23.26	21.01	23.26	22.51	23.26	22.51	23.26	23.26	22.51	23.26	22.51	23.26	(59)
-------	-------	-------	-------	-------	-------	-------	-------	-------	-------	-------	-------	------

Combi loss for each month from Table 3a, 3b or 3c

0.00	0.00	0.00	0.00	0.00	0.00	0.00	0.00	0.00	0.00	0.00	0.00	(61)
------	------	------	------	------	------	------	------	------	------	------	------	------

Total heat required for water heating calculated for each month 0.85 x (45)m + (46)m + (57)m + (59)m + (61)m

217.07	191.31	200.90	180.06	176.43	157.62	151.34	166.11	165.83	186.71	197.47	211.83	(62)
--------	--------	--------	--------	--------	--------	--------	--------	--------	--------	--------	--------	------

Solar DHW input calculated using Appendix G or Appendix H

-58.38	-51.37	-52.43	-43.12	-40.04	-33.03	-27.94	-33.84	-34.83	-43.06	-49.89	-56.43	(63)
--------	--------	--------	--------	--------	--------	--------	--------	--------	--------	--------	--------	------

Output from water heater for each month (kWh/month) (62)m + (63)m

158.69	139.95	148.47	136.94	136.39	124.59	123.40	132.28	131.01	143.66	147.58	155.41	(64)
											$\sum(64)1...12 =$	1678.35

Heat gains from water heating (kWh/month) 0.25 x [0.85 x (45)m + (61)m] + 0.8 x [(46)m + (57)m + (59)m]

96.12	85.24	90.74	83.04	82.61	75.58	74.27	79.18	78.31	86.03	88.83	94.38	(65)
-------	-------	-------	-------	-------	-------	-------	-------	-------	-------	-------	-------	------

5. Internal gains

	Jan	Feb	Mar	Apr	May	Jun	Jul	Aug	Sep	Oct	Nov	Dec	
--	-----	-----	-----	-----	-----	-----	-----	-----	-----	-----	-----	-----	--

Metabolic gains (Table 5)

142.04	142.04	142.04	142.04	142.04	142.04	142.04	142.04	142.04	142.04	142.04	142.04	142.04	(66)
--------	--------	--------	--------	--------	--------	--------	--------	--------	--------	--------	--------	--------	------

Lighting gains (calculated in Appendix L, equation L9 or L9a), also see Table 5

24.81	22.04	17.92	13.57	10.14	8.56	9.25	12.03	16.14	20.49	23.92	25.50	(67)
-------	-------	-------	-------	-------	------	------	-------	-------	-------	-------	-------	------

Appliance gains (calculated in Appendix L, equation L13 or L13a), also see Table 5

278.28	281.17	273.89	258.40	238.84	220.46	208.19	205.30	212.58	228.07	247.62	266.00	(68)
--------	--------	--------	--------	--------	--------	--------	--------	--------	--------	--------	--------	------

Cooking gains (calculated in Appendix L, equation L15 or L15a), also see Table 5

37.20	37.20	37.20	37.20	37.20	37.20	37.20	37.20	37.20	37.20	37.20	37.20	(69)
-------	-------	-------	-------	-------	-------	-------	-------	-------	-------	-------	-------	------

Pump and fan gains (Table 5a)

3.00	3.00	3.00	3.00	3.00	3.00	3.00	3.00	3.00	3.00	3.00	3.00	(70)
------	------	------	------	------	------	------	------	------	------	------	------	------

Losses e.g. evaporation (Table 5)

-113.63	-113.63	-113.63	-113.63	-113.63	-113.63	-113.63	-113.63	-113.63	-113.63	-113.63	-113.63	(71)
---------	---------	---------	---------	---------	---------	---------	---------	---------	---------	---------	---------	------

Water heating gains (Table 5)

129.19	126.84	121.97	115.34	111.03	104.97	99.82	106.42	108.77	115.63	123.38	126.85	(72)
--------	--------	--------	--------	--------	--------	-------	--------	--------	--------	--------	--------	------

Total internal gains (66)m + (67)m + (68)m + (69)m + (70)m + (71)m + (72)m

500.89	498.66	482.39	455.91	428.63	402.61	385.87	392.36	406.09	432.80	463.53	486.97	(73)
--------	--------	--------	--------	--------	--------	--------	--------	--------	--------	--------	--------	------

6. Solar gains

	Access factor Table 6d	Area m ²	Solar flux W/m ²	g specific data or Table 6b	FF specific data or Table 6c	Gains W	
NorthWest	0.77	7.15	11.28	0.9 x 0.63	0.70	24.65	(81)
SouthWest	0.77	3.21	36.79	0.9 x 0.63	0.70	36.10	(79)
SouthEast	0.77	14.51	36.79	0.9 x 0.63	0.70	163.16	(77)
North	0.77	0.52	10.63	0.9 x 0.63	0.70	1.69	(74)
NorthEast	0.77	2.67	11.28	0.9 x 0.63	0.70	9.21	(75)
East	0.77	0.53	19.64	0.9 x 0.63	0.70	3.18	(76)

Solar gains in watts $\sum(74)m... (82)m$

237.99	417.78	604.31	803.11	948.83	963.56	920.00	808.04	672.67	470.58	287.32	202.20	(83)
--------	--------	--------	--------	--------	--------	--------	--------	--------	--------	--------	--------	------

Total gains - internal and solar (73)m + (83)m

738.88	916.44	1086.70	1259.02	1377.46	1366.17	1305.87	1200.39	1078.76	903.38	750.85	689.16	(84)
--------	--------	---------	---------	---------	---------	---------	---------	---------	--------	--------	--------	------

7. Mean internal temperature (heating season)

Temperature during heating periods in the living area from Table 9, Th1(°C) 21.00 (85)

Jan	Feb	Mar	Apr	May	Jun	Jul	Aug	Sep	Oct	Nov	Dec
-----	-----	-----	-----	-----	-----	-----	-----	-----	-----	-----	-----

Utilisation factor for gains for living area n1,m (see Table 9a)

0.99	0.98	0.96	0.90	0.79	0.62	0.48	0.53	0.77	0.94	0.99	0.99	(86)
------	------	------	------	------	------	------	------	------	------	------	------	------

Mean internal temp of living area T1 (steps 3 to 7 in Table 9c)

19.25	19.51	19.89	20.35	20.71	20.92	20.98	20.97	20.81	20.32	19.70	19.21	(87)
-------	-------	-------	-------	-------	-------	-------	-------	-------	-------	-------	-------	------

Temperature during heating periods in the rest of dwelling from Table 9, Th2(°C)

19.82	19.83	19.83	19.84	19.85	19.86	19.86	19.86	19.85	19.85	19.84	19.83	(88)
-------	-------	-------	-------	-------	-------	-------	-------	-------	-------	-------	-------	------

Utilisation factor for gains for rest of dwelling n2,m

0.99	0.98	0.95	0.88	0.73	0.53	0.36	0.41	0.69	0.92	0.98	0.99	(89)
------	------	------	------	------	------	------	------	------	------	------	------	------

Mean internal temperature in the rest of dwelling T2 (follow steps 3 to 7 in Table 9c)

17.52	17.89	18.43	19.09	19.56	19.80	19.85	19.84	19.70	19.07	18.18	17.47	(90)
-------	-------	-------	-------	-------	-------	-------	-------	-------	-------	-------	-------	------

Living area fraction

Living area ÷ (4) = 0.18 (91)

Mean internal temperature for the whole dwelling fLA x T1 +(1 - fLA) x T2

17.83	18.18	18.69	19.32	19.77	20.00	20.05	20.04	19.90	19.29	18.45	17.78	(92)
-------	-------	-------	-------	-------	-------	-------	-------	-------	-------	-------	-------	------

Apply adjustment to the mean internal temperature from Table 4e where appropriate

17.68	18.03	18.54	19.17	19.62	19.85	19.90	19.89	19.75	19.14	18.30	17.63	(93)
-------	-------	-------	-------	-------	-------	-------	-------	-------	-------	-------	-------	------

8. Space heating requirement

Utilisation factor for gains, ηm

0.98	0.97	0.93	0.86	0.72	0.53	0.37	0.42	0.68	0.90	0.97	0.99	(94)
------	------	------	------	------	------	------	------	------	------	------	------	------

Useful gains, ηmGm, W (94)m x (84)m

727.33	887.12	1014.88	1079.68	995.29	728.50	476.79	499.51	731.15	811.85	729.31	680.61	(95)
--------	--------	---------	---------	--------	--------	--------	--------	--------	--------	--------	--------	------

Monthly average external temperature from Table U1

4.30	4.90	6.50	8.90	11.70	14.60	16.60	16.40	14.10	10.60	7.10	4.20	(96)
------	------	------	------	-------	-------	-------	-------	-------	-------	------	------	------

Heat loss rate for mean internal temperature, Lm, W [(39)m x [(93)m - (96)m]

2032.69	1989.05	1819.44	1529.28	1176.33	769.90	484.09	511.44	832.60	1268.83	1672.70	2016.87	(97)
---------	---------	---------	---------	---------	--------	--------	--------	--------	---------	---------	---------	------

Space heating requirement, kWh/month 0.024 x [(97)m - (95)m] x (41)m

971.19	740.49	598.59	323.71	134.69	0.00	0.00	0.00	339.99	679.24	994.18	(98)
--------	--------	--------	--------	--------	------	------	------	--------	--------	--------	------

$\sum(98)1...5, 10...12 =$ 4782.08 (98)

Space heating requirement kWh/m²/year

(98) ÷ (4) = 41.66 (99)

9a. Energy requirements - individual heating systems including micro-CHP

Space heating

Fraction of space heat from secondary/supplementary system (table 11)

0.00 (201)

Fraction of space heat from main system(s)

1 - (201) = 1.00 (202)

Fraction of space heat from main system 2

0.00 (202)

Fraction of total space heat from main system 1

(202) x [1 - (203)] = 1.00 (204)

Fraction of total space heat from main system 2

(202) x (203) = 0.00 (205)

Efficiency of main system 1 (%)

93.00 (206)

Jan	Feb	Mar	Apr	May	Jun	Jul	Aug	Sep	Oct	Nov	Dec
-----	-----	-----	-----	-----	-----	-----	-----	-----	-----	-----	-----

Space heating fuel (main system 1), kWh/month

1044.28	796.23	643.65	348.07	144.83	0.00	0.00	0.00	0.00	365.58	730.36	1069.01	(211)
---------	--------	--------	--------	--------	------	------	------	------	--------	--------	---------	-------

$\sum(211)1...5, 10...12 =$ 5142.02 (211)

Water heating

Efficiency of water heater

88.33	88.11	87.65	86.53	84.28	79.30	79.30	79.30	79.30	86.53	87.88	88.39	(217)	
Water heating fuel, kWh/month													
179.66	158.83	169.39	158.25	161.84	157.11	155.61	166.80	165.20	166.02	167.93	175.82		
											$\Sigma(219a)1...12 =$	1982.48	(219)

Annual totals

Space heating fuel - main system 1		5142.02	
Water heating fuel		1982.48	
Electricity for pumps, fans and electric keep-hot (Table 4f)			
central heating pump or water pump within warm air heating unit	30.00		(230c)
boiler flue fan	45.00		(230e)
Total electricity for the above, kWh/year		75.00	(231)
Electricity for lighting (Appendix L)		438.13	(232)
Total delivered energy for all uses	$(211)...(221) + (231) + (232)...(237b) =$	7637.63	(238)

10a. Fuel costs - individual heating systems including micro-CHP

	Fuel kWh/year		Fuel price		Fuel cost £/year	
Space heating - main system 1	5142.02	x	3.48	x 0.01 =	178.94	(240)
Water heating	1982.48	x	3.48	x 0.01 =	68.99	(247)
Pumps and fans	75.00	x	13.19	x 0.01 =	9.89	(249)
Electricity for lighting	438.13	x	13.19	x 0.01 =	57.79	(250)
Additional standing charges					120.00	(251)
Total energy cost				$(240)...(242) + (245)...(254) =$	435.61	(255)

11a. SAP rating - individual heating systems including micro-CHP

Energy cost deflator (Table 12)	0.42	(256)
Energy cost factor (ECF)	1.14	(257)
SAP value	84.03	
SAP rating (section 13)	84	(258)
SAP band	B	

12a. CO₂ emissions - individual heating systems including micro-CHP

	Energy kWh/year		Emission factor kg CO ₂ /kWh		Emissions kg CO ₂ /year	
Space heating - main system 1	5142.02	x	0.216	=	1110.68	(261)
Water heating	1982.48	x	0.216	=	428.22	(264)
Space and water heating				$(261) + (262) + (263) + (264) =$	1538.89	(265)
Pumps and fans	75.00	x	0.519	=	38.93	(267)
Electricity for lighting	438.13	x	0.519	=	227.39	(268)
Total CO ₂ , kg/year				$(265)...(271) =$	1805.21	(272)
Dwelling CO ₂ emission rate				$(272) \div (4) =$	15.72	(273)
EI value					84.86	
EI rating (section 14)					85	(274)
EI band					B	

13a. Primary energy - individual heating systems including micro-CHP

	Energy kWh/year		Primary factor		Primary Energy kWh/year	
Space heating - main system 1	5142.02	x	1.22	=	6273.26	(261)
Water heating	1982.48	x	1.22	=	2418.62	(264)

Space and water heating			$(261) + (262) + (263) + (264) =$	8691.89	(265)	
Pumps and fans	75.00	x	3.07	=	230.25	(267)
Electricity for lighting	438.13	x	3.07	=	1345.07	(268)
Primary energy kWh/year					10267.20	(272)
Dwelling primary energy rate kWh/m ² /year					89.44	(273)

DER Worksheet

Design - Draft



This design submission has been carried out using Approved SAP software. It has been prepared from plans and specifications and may not reflect the property as constructed.

Assessor name	Mr Simon Gowing	Assessor number	9641
Client		Last modified	29/10/2018
Address	AH2B -END Oxford Road, Bodicaote, OX15		

1. Overall dwelling dimensions

	Area (m ²)	Average storey height (m)	Volume (m ³)
Lowest occupied +1	39.10 (1a) x 2.39 (2a) =		93.45 (3a)
Total floor area	39.10 (1b) x 2.61 (2b) =		102.05 (3b)
Dwelling volume	(1a) + (1b) + (1c) + (1d)...(1n) =	(3a) + (3b) + (3c) + (3d)...(3n) =	78.20 (4) 195.50 (5)

2. Ventilation rate

		m ³ per hour
Number of chimneys	0 x 40 =	0 (6a)
Number of open flues	0 x 20 =	0 (6b)
Number of intermittent fans	3 x 10 =	30 (7a)
Number of passive vents	0 x 10 =	0 (7b)
Number of flueless gas fires	0 x 40 =	0 (7c)

Air changes per hour
 Infiltration due to chimneys, flues, fans, PSVs (6a) + (6b) + (7a) + (7b) + (7c) = 30 ÷ (5) = 0.15 (8)

If a pressurisation test has been carried out or is intended, proceed to (17), otherwise continue from (9) to (16)

Air permeability value, q50, expressed in cubic metres per hour per square metre of envelope area	5.00 (17)
If based on air permeability value, then (18) = [(17) ÷ 20] + (8), otherwise (18) = (16)	0.40 (18)
Number of sides on which the dwelling is sheltered	2 (19)
Shelter factor	1 - [0.075 x (19)] = 0.85 (20)
Infiltration rate incorporating shelter factor	(18) x (20) = 0.34 (21)

	Jan	Feb	Mar	Apr	May	Jun	Jul	Aug	Sep	Oct	Nov	Dec
Monthly average wind speed from Table U2	5.10	5.00	4.90	4.40	4.30	3.80	3.80	3.70	4.00	4.30	4.50	4.70

	Jan	Feb	Mar	Apr	May	Jun	Jul	Aug	Sep	Oct	Nov	Dec
Wind factor (22)m ÷ 4	1.28	1.25	1.23	1.10	1.08	0.95	0.95	0.93	1.00	1.08	1.13	1.18

	Jan	Feb	Mar	Apr	May	Jun	Jul	Aug	Sep	Oct	Nov	Dec
Adjusted infiltration rate (allowing for shelter and wind factor) (21) x (22a)m	0.44	0.43	0.42	0.38	0.37	0.33	0.33	0.32	0.34	0.37	0.39	0.40

Calculate effective air change rate for the applicable case:	
If mechanical ventilation: air change rate through system	N/A (23a)
If balanced with heat recovery: efficiency in % allowing for in-use factor from Table 4h	N/A (23c)
d) natural ventilation or whole house positive input ventilation from loft	0.60 0.59 0.59 0.57 0.57 0.55 0.55 0.55 0.56 0.57 0.57 0.58 (24d)

Effective air change rate - enter (24a) or (24b) or (24c) or (24d) in (25)

0.60	0.59	0.59	0.57	0.57	0.55	0.55	0.55	0.56	0.57	0.57	0.58
------	------	------	------	------	------	------	------	------	------	------	------

3. Heat losses and heat loss parameter

Element	Gross area, m ²	Openings m ²	Net area A, m ²	U-value W/m ² K	A x U W/K	k-value, kJ/m ² .K	A x k, kJ/K
Window			10.89	1.24	13.46		
Door			2.12	1.30	2.76		
Ground floor			38.91	0.15	5.84		
External wall			76.02	0.21	15.96		
Party wall			42.76	0.00	0.00		
Roof			38.90	0.11	4.28		
Total area of external elements ΣA, m ²			166.84				
Fabric heat loss, W/K = Σ(A x U)						(26)...(30) + (32) =	42.29 (33)
Heat capacity Cm = Σ(A x k)						(28)...(30) + (32a)...(32e) =	N/A (34)
Thermal mass parameter (TMP) in kJ/m ² K							250.00 (35)
Thermal bridges: Σ(L x Ψ) calculated using Appendix K							8.76 (36)
Total fabric heat loss						(33) + (36) =	51.06 (37)

	Jan	Feb	Mar	Apr	May	Jun	Jul	Aug	Sep	Oct	Nov	Dec
Ventilation heat loss calculated monthly 0.33 x (25)m x (5)	38.42	38.19	37.95	36.85	36.64	35.68	35.68	35.50	36.05	36.64	37.06	37.50

	Jan	Feb	Mar	Apr	May	Jun	Jul	Aug	Sep	Oct	Nov	Dec
Heat transfer coefficient, W/K (37)m + (38)m	89.48	89.24	89.01	87.90	87.70	86.74	86.74	86.56	87.11	87.70	88.12	88.55
Average = Σ(39)1...12/12 =	87.90 (39)											

	Jan	Feb	Mar	Apr	May	Jun	Jul	Aug	Sep	Oct	Nov	Dec
Heat loss parameter (HLP), W/m ² K (39)m ÷ (4)	1.14	1.14	1.14	1.12	1.12	1.11	1.11	1.11	1.11	1.12	1.13	1.13
Average = Σ(40)1...12/12 =	1.12 (40)											

	Jan	Feb	Mar	Apr	May	Jun	Jul	Aug	Sep	Oct	Nov	Dec
Number of days in month (Table 1a)	31.00	28.00	31.00	30.00	31.00	30.00	31.00	31.00	30.00	31.00	30.00	31.00

4. Water heating energy requirement

Assumed occupancy, N	2.43 (42)
Annual average hot water usage in litres per day Vd,average = (25 x N) + 36	91.86 (43)
Hot water usage in litres per day for each month Vd,m = factor from Table 1c x (43)	101.05 97.37 93.70 90.02 86.35 82.67 82.67 86.35 90.02 93.70 97.37 101.05
Σ(44)1...12 =	1102.33 (44)

	Jan	Feb	Mar	Apr	May	Jun	Jul	Aug	Sep	Oct	Nov	Dec
Energy content of hot water used = 4.18 x Vd,m x nm x Tm/3600 kWh/month (see Tables 1b, 1c 1d)	149.85	131.06	135.24	117.91	113.13	97.63	90.47	103.81	105.05	122.43	133.64	145.12
Σ(45)1...12 =	1445.33 (45)											

	Jan	Feb	Mar	Apr	May	Jun	Jul	Aug	Sep	Oct	Nov	Dec
Distribution loss 0.15 x (45)m	22.48	19.66	20.29	17.69	16.97	14.64	13.57	15.57	15.76	18.36	20.05	21.77

	Jan	Feb	Mar	Apr	May	Jun	Jul	Aug	Sep	Oct	Nov	Dec
Water storage loss calculated for each month (55) x (41)m	0.00	0.00	0.00	0.00	0.00	0.00	0.00	0.00	0.00	0.00	0.00	0.00

If the vessel contains dedicated solar storage or dedicated WWHRS (56)m x [(47) - Vs] ÷ (47), else (56)	0.00 0.00 0.00 0.00 0.00 0.00 0.00 0.00 0.00 0.00 0.00 0.00 (57)
---	--

	Jan	Feb	Mar	Apr	May	Jun	Jul	Aug	Sep	Oct	Nov	Dec
Primary circuit loss for each month from Table 3	0.00	0.00	0.00	0.00	0.00	0.00	0.00	0.00	0.00	0.00	0.00	0.00

	Jan	Feb	Mar	Apr	May	Jun	Jul	Aug	Sep	Oct	Nov	Dec
Combi loss for each month from Table 3a, 3b or 3c	21.91	19.75	21.81	21.03	21.68	20.92	21.58	21.64	20.98	21.75	21.14	21.89



Total heat required for water heating calculated for each month $0.85 \times (45)m + (46)m + (57)m + (59)m + (61)m$

171.76	150.81	157.05	138.94	134.81	118.55	112.04	125.45	126.03	144.18	154.77	167.01	(62)
--------	--------	--------	--------	--------	--------	--------	--------	--------	--------	--------	--------	------

Solar DHW input calculated using Appendix G or Appendix H

-48.32	-42.52	-43.40	-35.72	-33.17	-27.37	-23.17	-28.05	-28.87	-35.68	-41.31	-46.70	(63)
--------	--------	--------	--------	--------	--------	--------	--------	--------	--------	--------	--------	------

Output from water heater for each month (kWh/month) (62)m + (63)m

123.43	108.30	113.65	103.22	101.64	91.18	88.87	97.40	97.16	108.50	113.46	120.30	(64)
$\Sigma(64)1...12 =$											1267.12	

Heat gains from water heating (kWh/month) $0.25 \times [0.85 \times (45)m + (61)m] + 0.8 \times [(46)m + (57)m + (59)m]$

55.30	48.52	50.42	44.46	43.04	37.69	35.47	39.93	40.17	46.15	49.72	53.72	(65)
-------	-------	-------	-------	-------	-------	-------	-------	-------	-------	-------	-------	------

5. Internal gains

Metabolic gains (Table 5)

Jan	Feb	Mar	Apr	May	Jun	Jul	Aug	Sep	Oct	Nov	Dec	
121.39	121.39	121.39	121.39	121.39	121.39	121.39	121.39	121.39	121.39	121.39	121.39	(66)

Lighting gains (calculated in Appendix L, equation L9 or L9a), also see Table 5

20.65	18.34	14.91	11.29	8.44	7.13	7.70	10.01	13.43	17.06	19.91	21.22	(67)
-------	-------	-------	-------	------	------	------	-------	-------	-------	-------	-------	------

Appliance gains (calculated in Appendix L, equation L13 or L13a), also see Table 5

215.64	217.88	212.24	200.23	185.08	170.84	161.32	159.08	164.72	176.73	191.88	206.12	(68)
--------	--------	--------	--------	--------	--------	--------	--------	--------	--------	--------	--------	------

Cooking gains (calculated in Appendix L, equation L15 or L15a), also see Table 5

35.14	35.14	35.14	35.14	35.14	35.14	35.14	35.14	35.14	35.14	35.14	35.14	(69)
-------	-------	-------	-------	-------	-------	-------	-------	-------	-------	-------	-------	------

Pump and fan gains (Table 5a)

3.00	3.00	3.00	3.00	3.00	3.00	3.00	3.00	3.00	3.00	3.00	3.00	(70)
------	------	------	------	------	------	------	------	------	------	------	------	------

Losses e.g. evaporation (Table 5)

-97.11	-97.11	-97.11	-97.11	-97.11	-97.11	-97.11	-97.11	-97.11	-97.11	-97.11	-97.11	(71)
--------	--------	--------	--------	--------	--------	--------	--------	--------	--------	--------	--------	------

Water heating gains (Table 5)

74.33	72.20	67.77	61.75	57.85	52.35	47.68	53.67	55.80	62.02	69.05	72.21	(72)
-------	-------	-------	-------	-------	-------	-------	-------	-------	-------	-------	-------	------

Total internal gains (66)m + (67)m + (68)m + (69)m + (70)m + (71)m + (72)m

373.03	370.83	357.34	335.69	313.78	292.73	279.12	285.18	296.37	318.22	343.26	361.97	(73)
--------	--------	--------	--------	--------	--------	--------	--------	--------	--------	--------	--------	------

6. Solar gains

	Access factor Table 6d	Area m ²	Solar flux W/m ²	g specific data or Table 6b	FF specific data or Table 6c	Gains W	
East	0.77	2.77	19.64	0.9	0.63	16.63	(76)
West	0.77	4.89	19.64	0.9	0.63	29.35	(80)
SouthEast	0.77	2.63	36.79	0.9	0.63	29.57	(77)
South	0.77	0.60	46.75	0.9	0.63	8.57	(78)

Solar gains in watts $\Sigma(74)m... (82)m$

84.12	154.36	234.93	321.64	381.47	386.25	369.38	324.78	265.59	177.54	102.91	70.53	(83)
-------	--------	--------	--------	--------	--------	--------	--------	--------	--------	--------	-------	------

Total gains - internal and solar (73)m + (83)m

457.16	525.19	592.27	657.33	695.25	678.98	648.50	609.95	561.96	495.77	446.17	432.50	(84)
--------	--------	--------	--------	--------	--------	--------	--------	--------	--------	--------	--------	------

7. Mean internal temperature (heating season)

Temperature during heating periods in the living area from Table 9, Th1(°C)

21.00	(85)
-------	------

Utilisation factor for gains for living area n1,m (see Table 9a)

1.00	1.00	0.99	0.97	0.90	0.74	0.57	0.63	0.86	0.98	1.00	1.00	(86)
------	------	------	------	------	------	------	------	------	------	------	------	------

Mean internal temp of living area T1 (steps 3 to 7 in Table 9c)

19.75	19.90	20.15	20.48	20.77	20.94	20.99	20.98	20.86	20.49	20.06	19.73	(87)
-------	-------	-------	-------	-------	-------	-------	-------	-------	-------	-------	-------	------

Temperature during heating periods in the rest of dwelling from Table 9, Th2(°C)

19.96	19.97	19.97	19.98	19.98	19.99	19.99	20.00	19.99	19.98	19.98	19.97	(88)
-------	-------	-------	-------	-------	-------	-------	-------	-------	-------	-------	-------	------

Utilisation factor for gains for rest of dwelling n2,m

1.00	0.99	0.99	0.95	0.85	0.65	0.45	0.50	0.80	0.97	0.99	1.00	(89)
------	------	------	------	------	------	------	------	------	------	------	------	------

Mean internal temperature in the rest of dwelling T2 (follow steps 3 to 7 in Table 9c)

18.30	18.52	18.89	19.37	19.75	19.95	19.99	19.99	19.87	19.38	18.76	18.27	(90)
-------	-------	-------	-------	-------	-------	-------	-------	-------	-------	-------	-------	------

Living area fraction

Living area ÷ (4) =	0.23	(91)
---------------------	------	------

Mean internal temperature for the whole dwelling fLA x T1 + (1 - fLA) x T2

18.63	18.83	19.17	19.62	19.98	20.17	20.21	20.21	20.10	19.63	19.05	18.60	(92)
-------	-------	-------	-------	-------	-------	-------	-------	-------	-------	-------	-------	------

Apply adjustment to the mean internal temperature from Table 4e where appropriate

18.48	18.68	19.02	19.47	19.83	20.02	20.06	20.06	19.95	19.48	18.90	18.45	(93)
-------	-------	-------	-------	-------	-------	-------	-------	-------	-------	-------	-------	------

8. Space heating requirement

Utilisation factor for gains, ηm

1.00	0.99	0.98	0.94	0.85	0.66	0.46	0.51	0.79	0.96	0.99	1.00	(94)
------	------	------	------	------	------	------	------	------	------	------	------	------

Useful gains, ηmGm, W (94)m x (84)m

455.46	521.09	580.75	620.13	588.98	446.37	297.45	311.72	446.07	476.78	442.78	431.27	(95)
--------	--------	--------	--------	--------	--------	--------	--------	--------	--------	--------	--------	------

Monthly average external temperature from Table U1

4.30	4.90	6.50	8.90	11.70	14.60	16.60	16.40	14.10	10.60	7.10	4.20	(96)
------	------	------	------	-------	-------	-------	-------	-------	-------	------	------	------

Heat loss rate for mean internal temperature, Lm, W [(93)m x ((93)m - (96)m)]

1268.67	1229.86	1114.52	929.00	712.95	470.55	300.49	316.93	509.34	778.59	1039.98	1261.92	(97)
---------	---------	---------	--------	--------	--------	--------	--------	--------	--------	---------	---------	------

Space heating requirement, kWh/month $0.024 \times [(97)m - (95)m] \times (41)m$

605.03	476.29	397.12	222.39	92.23	0.00	0.00	0.00	0.00	224.55	429.98	618.00	(98)
--------	--------	--------	--------	-------	------	------	------	------	--------	--------	--------	------

Space heating requirement kWh/m²/year

$\Sigma(98)1...5, 10...12 =$	3065.59	(98)
------------------------------	---------	------

(98) ÷ (4)	39.20	(99)
------------	-------	------

9a. Energy requirements - individual heating systems including micro-CHP

Space heating

Fraction of space heat from secondary/supplementary system (table 11)

0.00	(201)
------	-------

Fraction of space heat from main system(s)

1 - (201) =	1.00	(202)
-------------	------	-------

Fraction of space heat from main system 2

0.00	(202)
------	-------

Fraction of total space heat from main system 1

(202) x [1 - (203)] =	1.00	(204)
-----------------------	------	-------

Fraction of total space heat from main system 2

(202) x (203) =	0.00	(205)
-----------------	------	-------

Efficiency of main system 1 (%)

93.00	(206)
-------	-------

Space heating fuel (main system 1), kWh/month

650.57	512.14	427.01	239.13	99.17	0.00	0.00	0.00	0.00	241.45	462.35	664.52	(211)
--------	--------	--------	--------	-------	------	------	------	------	--------	--------	--------	-------

$\Sigma(211)1...5, 10...12 =$	3296.34	(211)
-------------------------------	---------	-------

Water heating

Efficiency of water heater

89.42	89.37	89.24	88.93	88.24	86.70	86.70	86.70	86.70	88.90	89.29	89.45	(217)
-------	-------	-------	-------	-------	-------	-------	-------	-------	-------	-------	-------	-------

Water heating fuel, kWh/month

138.03	121.18	127.35	116.07	115.19	105.16	102.50	112.34	112.07	122.05	127.07	134.50	(219)
--------	--------	--------	--------	--------	--------	--------	--------	--------	--------	--------	--------	-------

$\Sigma(219a)1...12 =$	1433.52	(219)
------------------------	---------	-------

Annual totals

Space heating fuel - main system 1

3296.34	(219)
---------	-------

Water heating fuel

1433.52	(219)
---------	-------

Electricity for pumps, fans and electric keep-hot (Table 4f)

central heating pump or water pump within warm air heating unit	30.00	(230c)
boiler flue fan	45.00	(230e)
Total electricity for the above, kWh/year	75.00	(231)
Electricity for lighting (Appendix L)	364.65	(232)
Total delivered energy for all uses	(211)...(221) + (231) + (232)...(237b) = 5169.51	(238)

10a. Fuel costs - individual heating systems including micro-CHP

	Fuel kWh/year		Fuel price		Fuel cost £/year	
Space heating - main system 1	3296.34	x	3.48	x 0.01 =	114.71	(240)
Water heating	1433.52	x	3.48	x 0.01 =	49.89	(247)
Pumps and fans	75.00	x	13.19	x 0.01 =	9.89	(249)
Electricity for lighting	364.65	x	13.19	x 0.01 =	48.10	(250)
Additional standing charges					120.00	(251)
Total energy cost				(240)...(242) + (245)...(254) =	342.59	(255)

11a. SAP rating - individual heating systems including micro-CHP

Energy cost deflator (Table 12)	0.42	(256)
Energy cost factor (ECF)	1.17	(257)
SAP value	83.71	
SAP rating (section 13)	84	(258)
SAP band	B	

12a. CO₂ emissions - individual heating systems including micro-CHP

	Energy kWh/year		Emission factor kg CO ₂ /kWh		Emissions kg CO ₂ /year	
Space heating - main system 1	3296.34	x	0.216	=	712.01	(261)
Water heating	1433.52	x	0.216	=	309.64	(264)
Space and water heating				(261) + (262) + (263) + (264) =	1021.65	(265)
Pumps and fans	75.00	x	0.519	=	38.93	(267)
Electricity for lighting	364.65	x	0.519	=	189.25	(268)
Total CO ₂ , kg/year				(265)...(271) =	1249.83	(272)
Dwelling CO ₂ emission rate				(272) ÷ (4) =	15.98	(273)
EI value					86.41	
EI rating (section 14)					86	(274)
EI band					B	

13a. Primary energy - individual heating systems including micro-CHP

	Energy kWh/year		Primary factor		Primary Energy kWh/year	
Space heating - main system 1	3296.34	x	1.22	=	4021.53	(261)
Water heating	1433.52	x	1.22	=	1748.90	(264)
Space and water heating				(261) + (262) + (263) + (264) =	5770.43	(265)
Pumps and fans	75.00	x	3.07	=	230.25	(267)
Electricity for lighting	364.65	x	3.07	=	1119.47	(268)
Primary energy kWh/year					7120.15	(272)
Dwelling primary energy rate kWh/m ² /year					91.05	(273)

DER Worksheet Design - Draft



This design submission has been carried out using Approved SAP software. It has been prepared from plans and specifications and may not reflect the property as constructed.

Assessor name	Mr Simon Gowing	Assessor number	9641
Client		Last modified	29/10/2018
Address	AH2B- MID Oxford Road, Bodicaote, OX15		

1. Overall dwelling dimensions

	Area (m ²)	Average storey height (m)	Volume (m ³)
Lowest occupied +1	39.10 (1a) x 39.10 (1b)	2.39 (2a) x 2.61 (2b)	93.45 (3a) x 102.05 (3b)
Total floor area	(1a) + (1b) + (1c) + (1d)...(1n) = 78.20 (4)		
Dwelling volume	(3a) + (3b) + (3c) + (3d)...(3n) = 195.50 (5)		

2. Ventilation rate

		m ³ per hour
Number of chimneys	0 x 40 =	0 (6a)
Number of open flues	0 x 20 =	0 (6b)
Number of intermittent fans	3 x 10 =	30 (7a)
Number of passive vents	0 x 10 =	0 (7b)
Number of flueless gas fires	0 x 40 =	0 (7c)
Infiltration due to chimneys, flues, fans, PSVs	(6a) + (6b) + (7a) + (7b) + (7c) = 30 ÷ (5) =	0.15 (8)
Air permeability value, q ₅₀ , expressed in cubic metres per hour per square metre of envelope area		5.00 (17)
If based on air permeability value, then (18) = [(17) ÷ 20] + (8), otherwise (18) = (16)		0.40 (18)
Number of sides on which the dwelling is sheltered		2 (19)
Shelter factor	1 - [0.075 x (19)] =	0.85 (20)
Infiltration rate incorporating shelter factor	(18) x (20) =	0.34 (21)

	Jan	Feb	Mar	Apr	May	Jun	Jul	Aug	Sep	Oct	Nov	Dec
Monthly average wind speed from Table U2	5.10	5.00	4.90	4.40	4.30	3.80	3.80	3.70	4.00	4.30	4.50	4.70
Wind factor (22)m ÷ 4	1.28	1.25	1.23	1.10	1.08	0.95	0.95	0.93	1.00	1.08	1.13	1.18

	Jan	Feb	Mar	Apr	May	Jun	Jul	Aug	Sep	Oct	Nov	Dec
Adjusted infiltration rate (allowing for shelter and wind factor) (21) x (22a)m	0.44	0.43	0.42	0.38	0.37	0.33	0.33	0.32	0.34	0.37	0.39	0.40

Calculate effective air change rate for the applicable case:	
If mechanical ventilation: air change rate through system	N/A (23a)
If balanced with heat recovery: efficiency in % allowing for in-use factor from Table 4h	N/A (23c)
d) natural ventilation or whole house positive input ventilation from loft	0.60 0.59 0.59 0.57 0.57 0.55 0.55 0.55 0.56 0.57 0.57 0.58 (24d)

Effective air change rate - enter (24a) or (24b) or (24c) or (24d) in (25)



0.60	0.59	0.59	0.57	0.57	0.55	0.55	0.55	0.56	0.57	0.57	0.58
------	------	------	------	------	------	------	------	------	------	------	------

(25)

3. Heat losses and heat loss parameter

Element	Gross area, m ²	Openings m ²	Net area A, m ²	U-value W/m ² K	A x U W/K	k-value, kJ/m ² .K	A x k, kJ/K
Window			10.29	1.24	12.72		
Door			2.12	1.30	2.76		
Ground floor			38.91	0.15	5.84		
External wall			33.29	0.21	6.99		
Party wall			85.59	0.00	0.00		
Roof			38.90	0.11	4.28		
Total area of external elements ΣA , m ²			123.51				
Fabric heat loss, W/K = $\Sigma(A \times U)$					32.58		
Heat capacity Cm = $\Sigma(A \times k)$					N/A		
Thermal mass parameter (TMP) in kJ/m ² K					250.00		
Thermal bridges: $\Sigma(L \times \Psi)$ calculated using Appendix K					6.69		
Total fabric heat loss					39.27		

Jan	Feb	Mar	Apr	May	Jun	Jul	Aug	Sep	Oct	Nov	Dec
38.42	38.19	37.95	36.85	36.64	35.68	35.68	35.50	36.05	36.64	37.06	37.50

Jan	Feb	Mar	Apr	May	Jun	Jul	Aug	Sep	Oct	Nov	Dec
77.69	77.45	77.22	76.12	75.91	74.95	74.95	74.77	75.32	75.91	76.33	76.76
Average = $\Sigma(39)1...12/12 =$											76.12

Jan	Feb	Mar	Apr	May	Jun	Jul	Aug	Sep	Oct	Nov	Dec
0.99	0.99	0.99	0.97	0.97	0.96	0.96	0.96	0.96	0.97	0.98	0.98
Average = $\Sigma(40)1...12/12 =$											0.97

Jan	Feb	Mar	Apr	May	Jun	Jul	Aug	Sep	Oct	Nov	Dec
31.00	28.00	31.00	30.00	31.00	30.00	31.00	31.00	30.00	31.00	30.00	31.00

4. Water heating energy requirement

Assumed occupancy, N	2.43
Annual average hot water usage in litres per day Vd,average = (25 x N) + 36	91.86

Jan	Feb	Mar	Apr	May	Jun	Jul	Aug	Sep	Oct	Nov	Dec
101.05	97.37	93.70	90.02	86.35	82.67	82.67	86.35	90.02	93.70	97.37	101.05
Average = $\Sigma(44)1...12/12 =$											1102.33

Jan	Feb	Mar	Apr	May	Jun	Jul	Aug	Sep	Oct	Nov	Dec
149.85	131.06	135.24	117.91	113.13	97.63	90.47	103.81	105.05	122.43	133.64	145.12
Average = $\Sigma(45)1...12 =$											1445.33

Jan	Feb	Mar	Apr	May	Jun	Jul	Aug	Sep	Oct	Nov	Dec
22.48	19.66	20.29	17.69	16.97	14.64	13.57	15.57	15.76	18.36	20.05	21.77

Jan	Feb	Mar	Apr	May	Jun	Jul	Aug	Sep	Oct	Nov	Dec
0.00	0.00	0.00	0.00	0.00	0.00	0.00	0.00	0.00	0.00	0.00	0.00

Jan	Feb	Mar	Apr	May	Jun	Jul	Aug	Sep	Oct	Nov	Dec
0.00	0.00	0.00	0.00	0.00	0.00	0.00	0.00	0.00	0.00	0.00	0.00

Jan	Feb	Mar	Apr	May	Jun	Jul	Aug	Sep	Oct	Nov	Dec
0.00	0.00	0.00	0.00	0.00	0.00	0.00	0.00	0.00	0.00	0.00	0.00

Jan	Feb	Mar	Apr	May	Jun	Jul	Aug	Sep	Oct	Nov	Dec
21.91	19.75	21.81	21.03	21.68	20.92	21.58	21.64	20.98	21.75	21.14	21.89

171.76	150.81	157.05	138.94	134.81	118.55	112.04	125.45	126.03	144.18	154.77	167.01
--------	--------	--------	--------	--------	--------	--------	--------	--------	--------	--------	--------

-48.32	-42.52	-43.40	-35.72	-33.17	-27.37	-23.17	-28.05	-28.87	-35.68	-41.31	-46.70
--------	--------	--------	--------	--------	--------	--------	--------	--------	--------	--------	--------

Jan	Feb	Mar	Apr	May	Jun	Jul	Aug	Sep	Oct	Nov	Dec
123.43	108.30	113.65	103.22	101.64	91.18	88.87	97.40	97.16	108.50	113.46	120.30
Average = $\Sigma(64)1...12 =$											1267.12

Jan	Feb	Mar	Apr	May	Jun	Jul	Aug	Sep	Oct	Nov	Dec
55.30	48.52	50.42	44.46	43.04	37.69	35.47	39.93	40.17	46.15	49.72	53.72

5. Internal gains

Jan	Feb	Mar	Apr	May	Jun	Jul	Aug	Sep	Oct	Nov	Dec
121.39	121.39	121.39	121.39	121.39	121.39	121.39	121.39	121.39	121.39	121.39	121.39

Jan	Feb	Mar	Apr	May	Jun	Jul	Aug	Sep	Oct	Nov	Dec
20.91	18.57	15.10	11.43	8.55	7.21	7.80	10.13	13.60	17.27	20.16	21.49

Jan	Feb	Mar	Apr	May	Jun	Jul	Aug	Sep	Oct	Nov	Dec
215.64	217.88	212.24	200.23	185.08	170.84	161.32	159.08	164.72	176.73	191.88	206.12

Jan	Feb	Mar	Apr	May	Jun	Jul	Aug	Sep	Oct	Nov	Dec
35.14	35.14	35.14	35.14	35.14	35.14	35.14	35.14	35.14	35.14	35.14	35.14

Jan	Feb	Mar	Apr	May	Jun	Jul	Aug	Sep	Oct	Nov	Dec
3.00	3.00	3.00	3.00	3.00	3.00	3.00	3.00	3.00	3.00	3.00	3.00

Jan	Feb	Mar	Apr	May	Jun	Jul	Aug	Sep	Oct	Nov	Dec
-97.11	-97.11	-97.11	-97.11	-97.11	-97.11	-97.11	-97.11	-97.11	-97.11	-97.11	-97.11

Jan	Feb	Mar	Apr	May	Jun	Jul	Aug	Sep	Oct	Nov	Dec
74.33	72.20	67.77	61.75	57.85	52.35	47.68	53.67	55.80	62.02	69.05	72.21

Jan	Feb	Mar	Apr	May	Jun	Jul	Aug	Sep	Oct	Nov	Dec
373.29	371.06	357.52	335.83	313.89	292.82	279.22	285.30	296.54	318.44	343.51	362.24

6. Solar gains

	Access factor Table 6d	Area m ²	Solar flux W/m ²	g specific data or Table 6b	FF specific data or Table 6c	Gains W
SouthWest	0.77	2.77	36.79	0.63	0.70	31.15
NorthEast	0.77	7.52	11.28	0.63	0.70	25.93

Jan	Feb	Mar	Apr	May	Jun	Jul	Aug	Sep	Oct	Nov	Dec
57.08	105.84	167.69	246.12	310.68	323.83	305.80	255.28	194.48	123.14	69.94	47.83

Jan	Feb	Mar	Apr	May	Jun	Jul	Aug	Sep	Oct	Nov	Dec
430.37	476.90	525.21	581.96	624.57	616.65	585.02	540.59	491.02	441.58	413.44	410.07

7. Mean internal temperature (heating season)

Jan	Feb	Mar	Apr	May	Jun	Jul	Aug	Sep	Oct	Nov	Dec
21.00	21.00	21.00	21.00	21.00	21.00	21.00	21.00	21.00	21.00	21.00	21.00

Jan	Feb	Mar	Apr	May	Jun	Jul	Aug	Sep	Oct	Nov	Dec
1.00	1.00	0.99	0.97	0.90	0.73	0.55	0.62	0.88	0.98	1.00	1.00

Jan	Feb	Mar	Apr	May	Jun	Jul	Aug	Sep	Oct	Nov	Dec
19.93	20.05	20.26	20.56	20.82	20.96	20.99	20.99	20.89	20.56	20.20	19.91

Jan	Feb	Mar	Apr	May	Jun	Jul	Aug	Sep	Oct	Nov	Dec
20.09	20.09	20.09	20.11	20.11	20.12	20.12	20.12	20.11	20.11	20.10	20.10

Utilisation factor for gains for rest of dwelling n2,m	1.00	1.00	0.99	0.96	0.86	0.65	0.45	0.51	0.82	0.98	1.00	1.00	(89)
--	------	------	------	------	------	------	------	------	------	------	------	------	------

Mean internal temperature in the rest of dwelling T2 (follow steps 3 to 7 in Table 9c)	18.65	18.82	19.13	19.57	19.93	20.09	20.12	20.11	20.02	19.58	19.05	18.63	(90)
--	-------	-------	-------	-------	-------	-------	-------	-------	-------	-------	-------	-------	------

Living area fraction	Living area ÷ (4) =												0.23	(91)
----------------------	---------------------	--	--	--	--	--	--	--	--	--	--	--	------	------

Mean internal temperature for the whole dwelling fLA x T1 +(1 - fLA) x T2	18.94	19.10	19.39	19.80	20.13	20.29	20.31	20.31	20.22	19.80	19.31	18.92	(92)
---	-------	-------	-------	-------	-------	-------	-------	-------	-------	-------	-------	-------	------

Apply adjustment to the mean internal temperature from Table 4e where appropriate	18.79	18.95	19.24	19.65	19.98	20.14	20.16	20.16	20.07	19.65	19.16	18.77	(93)
---	-------	-------	-------	-------	-------	-------	-------	-------	-------	-------	-------	-------	------

8. Space heating requirement

	Jan	Feb	Mar	Apr	May	Jun	Jul	Aug	Sep	Oct	Nov	Dec	
Utilisation factor for gains, ηm	1.00	0.99	0.99	0.95	0.85	0.65	0.45	0.51	0.81	0.97	0.99	1.00	(94)

Useful gains, ηmGm, W (94)m x (84)m	429.22	474.40	518.21	555.66	533.91	400.67	265.62	278.31	399.07	428.62	411.13	409.23	(95)
-------------------------------------	--------	--------	--------	--------	--------	--------	--------	--------	--------	--------	--------	--------	------

Monthly average external temperature from Table U1	4.30	4.90	6.50	8.90	11.70	14.60	16.60	16.40	14.10	10.60	7.10	4.20	(96)
--	------	------	------	------	-------	-------	-------	-------	-------	-------	------	------	------

Heat loss rate for mean internal temperature, Lm, W [(39)m x ((93)m - (96)m)]	1125.41	1088.04	983.63	817.94	628.37	415.15	267.13	281.32	449.35	687.06	920.34	1118.22	(97)
---	---------	---------	--------	--------	--------	--------	--------	--------	--------	--------	--------	---------	------

Space heating requirement, kWh/month 0.024 x ((97)m - (95)m) x (41)m	517.97	412.36	346.27	188.84	70.28	0.00	0.00	0.00	192.28	366.63	527.49			
	$\Sigma(98)1...5, 10...12 =$												2622.13	(98)
	$(98) \div (4) =$												33.53	(99)

Space heating requirement kWh/m ² /year													33.53	(99)
--	--	--	--	--	--	--	--	--	--	--	--	--	-------	------

9a. Energy requirements - individual heating systems including micro-CHP

Space heating														
Fraction of space heat from secondary/supplementary system (table 11)													0.00	(201)
Fraction of space heat from main system(s)	1 - (201) =												1.00	(202)
Fraction of space heat from main system 2													0.00	(202)
Fraction of total space heat from main system 1	(202) x [1 - (203)] =												1.00	(204)
Fraction of total space heat from main system 2	(202) x (203) =												0.00	(205)
Efficiency of main system 1 (%)													93.00	(206)

	Jan	Feb	Mar	Apr	May	Jun	Jul	Aug	Sep	Oct	Nov	Dec		
Space heating fuel (main system 1), kWh/month	556.96	443.40	372.34	203.06	75.57	0.00	0.00	0.00	0.00	206.75	394.23	567.20		
	$\Sigma(211)1...5, 10...12 =$												2819.50	(211)

Water heating													
Efficiency of water heater	89.35	89.29	89.16	88.81	88.02	86.70	86.70	86.70	86.70	88.78	89.20	89.37	(217)

Water heating fuel, kWh/month	138.15	121.28	127.47	116.23	115.48	105.16	102.50	112.34	112.07	122.21	127.20	134.62		
	$\Sigma(219a)1...12 =$												1434.72	(219)

Annual totals														
Space heating fuel - main system 1													2819.50	
Water heating fuel													1434.72	
Electricity for pumps, fans and electric keep-hot (Table 4f)														
central heating pump or water pump within warm air heating unit													30.00	(230c)

boiler flue fan	45.00			(230e)
Total electricity for the above, kWh/year		75.00		(231)
Electricity for lighting (Appendix L)		369.22		(232)
Total delivered energy for all uses	(211)...(221) + (231) + (232)...(237b) =	4698.43		(238)

10a. Fuel costs - individual heating systems including micro-CHP

	Fuel kWh/year		Fuel price		Fuel cost £/year	
Space heating - main system 1	2819.50	x	3.48	x 0.01 =	98.12	(240)
Water heating	1434.72	x	3.48	x 0.01 =	49.93	(247)
Pumps and fans	75.00	x	13.19	x 0.01 =	9.89	(249)
Electricity for lighting	369.22	x	13.19	x 0.01 =	48.70	(250)
Additional standing charges					120.00	(251)
Total energy cost				(240)...(242) + (245)...(254) =	326.64	(255)

11a. SAP rating - individual heating systems including micro-CHP

Energy cost deflator (Table 12)	0.42	(256)
Energy cost factor (ECF)	1.11	(257)
SAP value	84.47	
SAP rating (section 13)	84	(258)
SAP band	B	

12a. CO₂ emissions - individual heating systems including micro-CHP

	Energy kWh/year		Emission factor kg CO ₂ /kWh		Emissions kg CO ₂ /year	
Space heating - main system 1	2819.50	x	0.216	=	609.01	(261)
Water heating	1434.72	x	0.216	=	309.90	(264)
Space and water heating				(261) + (262) + (263) + (264) =	918.91	(265)
Pumps and fans	75.00	x	0.519	=	38.93	(267)
Electricity for lighting	369.22	x	0.519	=	191.62	(268)
Total CO ₂ , kg/year				(265)...(271) =	1149.46	(272)
Dwelling CO ₂ emission rate				(272) ÷ (4) =	14.70	(273)
EI value					87.50	
EI rating (section 14)					87	(274)
EI band					B	

13a. Primary energy - individual heating systems including micro-CHP

	Energy kWh/year		Primary factor		Primary Energy kWh/year	
Space heating - main system 1	2819.50	x	1.22	=	3439.78	(261)
Water heating	1434.72	x	1.22	=	1750.36	(264)
Space and water heating				(261) + (262) + (263) + (264) =	5190.14	(265)
Pumps and fans	75.00	x	3.07	=	230.25	(267)
Electricity for lighting	369.22	x	3.07	=	1133.50	(268)
Primary energy kWh/year					6553.89	(272)
Dwelling primary energy rate kWh/m ² /year					83.81	(273)

This design submission has been carried out using Approved SAP software. It has been prepared from plans and specifications and may not reflect the property as constructed.

Assessor name	Mr Simon Gowing	Assessor number	9641
Client		Last modified	29/10/2018
Address	CALDER - DET CALDER - DET, Bodicaote, OX15		

1. Overall dwelling dimensions

	Area (m ²)	Average storey height (m)	Volume (m ³)
Lowest occupied +1	70.13 (1a) x 67.55 (1b) = 137.68 (4)	2.39 (2a) x 2.61 (2b) = 6.24 (2c)	167.61 (3a) x 176.31 (3b) = 343.92 (5)
Total floor area	(1a) + (1b) + (1c) + (1d)...(1n) = 137.68 (4)		
Dwelling volume	(3a) + (3b) + (3c) + (3d)...(3n) = 343.92 (5)		

2. Ventilation rate

		m ³ per hour
Number of chimneys	0 x 40 =	0 (6a)
Number of open flues	0 x 20 =	0 (6b)
Number of intermittent fans	5 x 10 =	50 (7a)
Number of passive vents	0 x 10 =	0 (7b)
Number of flueless gas fires	0 x 40 =	0 (7c)
Infiltration due to chimneys, flues, fans, PSVs	(6a) + (6b) + (7a) + (7b) + (7c) = 50 ÷ (5) =	0.15 (8)

If a pressurisation test has been carried out or is intended, proceed to (17), otherwise continue from (9) to (16)

Air permeability value, q50, expressed in cubic metres per hour per square metre of envelope area	5.00 (17)
If based on air permeability value, then (18) = [(17) ÷ 20] + (8), otherwise (18) = (16)	0.40 (18)
Number of sides on which the dwelling is sheltered	2 (19)
Shelter factor	1 - [0.075 x (19)] = 0.85 (20)
Infiltration rate incorporating shelter factor	(18) x (20) = 0.34 (21)

Infiltration rate modified for monthly wind speed:

	Jan	Feb	Mar	Apr	May	Jun	Jul	Aug	Sep	Oct	Nov	Dec
Monthly average wind speed from Table U2	5.10	5.00	4.90	4.40	4.30	3.80	3.80	3.70	4.00	4.30	4.50	4.70
Wind factor (22)m ÷ 4	1.28	1.25	1.23	1.10	1.08	0.95	0.95	0.93	1.00	1.08	1.13	1.18

Adjusted infiltration rate (allowing for shelter and wind factor) (21) x (22a)m	0.43	0.42	0.41	0.37	0.36	0.32	0.32	0.31	0.34	0.36	0.38	0.39
---	------	------	------	------	------	------	------	------	------	------	------	------

Calculate effective air change rate for the applicable case:

If mechanical ventilation: air change rate through system	N/A (23a)
If balanced with heat recovery: efficiency in % allowing for in-use factor from Table 4h	N/A (23c)
d) natural ventilation or whole house positive input ventilation from loft	0.59 0.59 0.58 0.57 0.57 0.55 0.55 0.55 0.56 0.57 0.57 0.58 (24d)

Effective air change rate - enter (24a) or (24b) or (24c) or (24d) in (25)

0.59	0.59	0.58	0.57	0.57	0.55	0.55	0.55	0.56	0.57	0.57	0.58
------	------	------	------	------	------	------	------	------	------	------	------

3. Heat losses and heat loss parameter

Element	Gross area, m ²	Openings m ²	Net area A, m ²	U-value W/m ² K	A x U W/K	k-value, kJ/m ² .K	A x k, kJ/K
Window			21.15	1.15	24.22		
Door			2.03	1.30	2.64		
Ground floor			70.13	0.16	11.22		
External wall			147.96	0.20	29.59		
Roof			70.12	0.11	7.71		
Total area of external elements ΣA, m ²			311.39				
Fabric heat loss, W/K = Σ(A x U)							75.38 (33)
Heat capacity Cm = Σ(A x k)							N/A (34)
Thermal mass parameter (TMP) in kJ/m ² K							100.00 (35)
Thermal bridges: Σ(L x Ψ) calculated using Appendix K							11.16 (36)
Total fabric heat loss							86.55 (37)

	Jan	Feb	Mar	Apr	May	Jun	Jul	Aug	Sep	Oct	Nov	Dec
Ventilation heat loss calculated monthly 0.33 x (25)m x (5)	67.17	66.76	66.36	64.50	64.15	62.53	62.53	62.23	63.16	64.15	64.86	65.60

Heat transfer coefficient, W/K (37)m + (38)m	153.71	153.31	152.91	151.05	150.70	149.08	149.08	148.78	149.70	150.70	151.40	152.14
Average = Σ(39)1...12/12 =	151.05 (39)											

Heat loss parameter (HLP), W/m ² K (39)m ÷ (4)	1.12	1.11	1.11	1.10	1.09	1.08	1.08	1.08	1.09	1.09	1.10	1.11
Average = Σ(40)1...12/12 =	1.10 (40)											

Number of days in month (Table 1a)	31.00	28.00	31.00	30.00	31.00	30.00	31.00	31.00	30.00	31.00	30.00	31.00
------------------------------------	-------	-------	-------	-------	-------	-------	-------	-------	-------	-------	-------	-------

4. Water heating energy requirement

Assumed occupancy, N	2.91 (42)
Annual average hot water usage in litres per day Vd,average = (25 x N) + 36	103.37 (43)

	Jan	Feb	Mar	Apr	May	Jun	Jul	Aug	Sep	Oct	Nov	Dec
Hot water usage in litres per day for each month Vd,m = factor from Table 1c x (43)	113.71	109.58	105.44	101.31	97.17	93.04	93.04	97.17	101.31	105.44	109.58	113.71
Σ(44)1...12 =	1240.47 (44)											

Energy content of hot water used = 4.18 x Vd,m x nm x Tm/3600 kWh/month (see Tables 1b, 1c 1d)	168.63	147.48	152.19	132.68	127.31	109.86	101.80	116.82	118.21	137.77	150.38	163.31
Σ(45)1...12 =	1626.45 (45)											

Distribution loss 0.15 x (45)m	25.29	22.12	22.83	19.90	19.10	16.48	15.27	17.52	17.73	20.67	22.56	24.50
Storage volume (litres) including any solar or WWHRS storage within same vessel	250.00 (47)											

Water storage loss:	
a) If manufacturer's declared loss factor is known (kWh/day)	1.67 (48)
Temperature factor from Table 2b	0.54 (49)
Energy lost from water storage (kWh/day) (48) x (49)	0.90 (50)
Enter (50) or (54) in (55)	0.90 (55)
Water storage loss calculated for each month (55) x (41)m	27.96 25.25 27.96 27.05 27.96 27.05 27.96 27.96 27.05 27.96 27.05 27.96
Σ(56)1...12 =	327.96 (56)

If the vessel contains dedicated solar storage or dedicated WWHRS (56)m x [(47) - Vs] ÷ (47), else (56)

27.96	25.25	27.96	27.05	27.96	27.05	27.96	27.96	27.05	27.96	27.05	27.96	(57)
-------	-------	-------	-------	-------	-------	-------	-------	-------	-------	-------	-------	------

Primary circuit loss for each month from Table 3

23.26	21.01	23.26	22.51	23.26	22.51	23.26	23.26	22.51	23.26	22.51	23.26	(59)
-------	-------	-------	-------	-------	-------	-------	-------	-------	-------	-------	-------	------

Combi loss for each month from Table 3a, 3b or 3c

0.00	0.00	0.00	0.00	0.00	0.00	0.00	0.00	0.00	0.00	0.00	0.00	(61)
------	------	------	------	------	------	------	------	------	------	------	------	------

Total heat required for water heating calculated for each month $0.85 \times (45)m + (46)m + (57)m + (59)m + (61)m$

219.85	193.75	203.41	182.25	178.53	159.43	153.02	168.04	167.78	188.99	199.95	214.53	(62)
--------	--------	--------	--------	--------	--------	--------	--------	--------	--------	--------	--------	------

Solar DHW input calculated using Appendix G or Appendix H

-39.77	-35.00	-35.72	-29.38	-27.27	-22.50	-19.03	-23.05	-23.72	-29.33	-33.99	-38.44	(63)
--------	--------	--------	--------	--------	--------	--------	--------	--------	--------	--------	--------	------

Output from water heater for each month (kWh/month) $(62)m + (63)m$

180.07	158.75	167.69	152.87	151.26	136.93	133.99	144.99	144.06	159.65	165.97	176.08	(64)
$\sum(64)1...12 =$											1872.31	

Heat gains from water heating (kWh/month) $0.25 \times [0.85 \times (45)m + (61)m] + 0.8 \times [(46)m + (57)m + (59)m]$

97.04	86.05	91.58	83.77	83.31	76.18	74.82	79.82	78.96	86.78	89.66	95.27	(65)
-------	-------	-------	-------	-------	-------	-------	-------	-------	-------	-------	-------	------

5. Internal gains

	Jan	Feb	Mar	Apr	May	Jun	Jul	Aug	Sep	Oct	Nov	Dec	
Metabolic gains (Table 5)	145.63	145.63	145.63	145.63	145.63	145.63	145.63	145.63	145.63	145.63	145.63	145.63	(66)

Lighting gains (calculated in Appendix L, equation L9 or L9a), also see Table 5

28.77	25.55	20.78	15.73	11.76	9.93	10.73	13.94	18.71	23.76	27.73	29.57	(67)
-------	-------	-------	-------	-------	------	-------	-------	-------	-------	-------	-------	------

Appliance gains (calculated in Appendix L, equation L13 or L13a), also see Table 5

306.76	309.94	301.92	284.84	263.29	243.03	229.49	226.31	234.33	251.41	272.96	293.22	(68)
--------	--------	--------	--------	--------	--------	--------	--------	--------	--------	--------	--------	------

Cooking gains (calculated in Appendix L, equation L15 or L15a), also see Table 5

37.56	37.56	37.56	37.56	37.56	37.56	37.56	37.56	37.56	37.56	37.56	37.56	(69)
-------	-------	-------	-------	-------	-------	-------	-------	-------	-------	-------	-------	------

Pump and fan gains (Table 5a)

3.00	3.00	3.00	3.00	3.00	3.00	3.00	3.00	3.00	3.00	3.00	3.00	(70)
------	------	------	------	------	------	------	------	------	------	------	------	------

Losses e.g. evaporation (Table 5)

-116.50	-116.50	-116.50	-116.50	-116.50	-116.50	-116.50	-116.50	-116.50	-116.50	-116.50	-116.50	(71)
---------	---------	---------	---------	---------	---------	---------	---------	---------	---------	---------	---------	------

Water heating gains (Table 5)

130.43	128.05	123.09	116.35	111.97	105.81	100.57	107.28	109.67	116.64	124.52	128.06	(72)
--------	--------	--------	--------	--------	--------	--------	--------	--------	--------	--------	--------	------

Total internal gains $(66)m + (67)m + (68)m + (69)m + (70)m + (71)m + (72)m$

535.65	533.23	515.48	486.61	456.70	428.45	410.48	417.22	432.40	461.50	494.91	520.53	(73)
--------	--------	--------	--------	--------	--------	--------	--------	--------	--------	--------	--------	------

6. Solar gains

	Access factor Table 6d	Area m ²	Solar flux W/m ²	g specific data or Table 6b	FF specific data or Table 6c	Gains W	
SouthWest	0.77	7.50	36.79	0.9×0.63	0.70	84.34	(79)
NorthWest	0.77	0.55	11.28	0.9×0.63	0.70	1.90	(81)
NorthEast	0.77	13.10	11.28	0.9×0.63	0.70	45.17	(75)

Solar gains in watts $\sum(74)m... (82)m$

131.40	239.46	369.17	527.02	653.84	677.06	641.13	542.24	423.16	275.85	160.24	110.61	(83)
--------	--------	--------	--------	--------	--------	--------	--------	--------	--------	--------	--------	------

Total gains - internal and solar $(73)m + (83)m$

667.05	772.69	884.65	1013.63	1110.55	1105.51	1051.61	959.47	855.56	737.35	655.15	631.15	(84)
--------	--------	--------	---------	---------	---------	---------	--------	--------	--------	--------	--------	------

7. Mean internal temperature (heating season)

Temperature during heating periods in the living area from Table 9, Th1(°C)

$\sum(85)1...12 =$											21.00	(85)
--------------------	--	--	--	--	--	--	--	--	--	--	-------	------

Jan	Feb	Mar	Apr	May	Jun	Jul	Aug	Sep	Oct	Nov	Dec
-----	-----	-----	-----	-----	-----	-----	-----	-----	-----	-----	-----

Utilisation factor for gains for living area n1,m (see Table 9a)

0.98	0.97	0.95	0.90	0.81	0.67	0.54	0.60	0.79	0.93	0.97	0.98	(86)
------	------	------	------	------	------	------	------	------	------	------	------	------

Mean internal temp of living area T1 (steps 3 to 7 in Table 9c)

18.49	18.74	19.18	19.79	20.33	20.72	20.89	20.85	20.53	19.83	19.06	18.45	(87)
-------	-------	-------	-------	-------	-------	-------	-------	-------	-------	-------	-------	------

Temperature during heating periods in the rest of dwelling from Table 9, Th2(°C)

19.99	19.99	19.99	20.00	20.01	20.01	20.01	20.02	20.01	20.01	20.00	20.00	(88)
-------	-------	-------	-------	-------	-------	-------	-------	-------	-------	-------	-------	------

Utilisation factor for gains for rest of dwelling n2,m

0.98	0.96	0.94	0.88	0.77	0.61	0.45	0.50	0.74	0.91	0.96	0.98	(89)
------	------	------	------	------	------	------	------	------	------	------	------	------

Mean internal temperature in the rest of dwelling T2 (follow steps 3 to 7 in Table 9c)

16.60	16.97	17.61	18.48	19.24	19.75	19.94	19.91	19.53	18.56	17.44	16.55	(90)
-------	-------	-------	-------	-------	-------	-------	-------	-------	-------	-------	-------	------

Living area fraction

Living area ÷ (4) = 0.15 (91)

Mean internal temperature for the whole dwelling $fLA \times T1 + (1 - fLA) \times T2$

16.89	17.24	17.85	18.68	19.40	19.90	20.08	20.05	19.68	18.75	17.69	16.84	(92)
-------	-------	-------	-------	-------	-------	-------	-------	-------	-------	-------	-------	------

Apply adjustment to the mean internal temperature from Table 4e where appropriate

16.74	17.09	17.70	18.53	19.25	19.75	19.93	19.90	19.53	18.60	17.54	16.69	(93)
-------	-------	-------	-------	-------	-------	-------	-------	-------	-------	-------	-------	------

8. Space heating requirement

	Jan	Feb	Mar	Apr	May	Jun	Jul	Aug	Sep	Oct	Nov	Dec	
Utilisation factor for gains, η_m	0.96	0.94	0.91	0.84	0.74	0.59	0.44	0.49	0.71	0.88	0.94	0.96	(94)

Useful gains, $\eta_m G_m$, W (94)m x (84)m

640.05	727.76	804.10	855.46	819.72	649.91	460.12	470.27	608.18	646.29	617.59	608.66	(95)
--------	--------	--------	--------	--------	--------	--------	--------	--------	--------	--------	--------	------

Monthly average external temperature from Table U1

4.30	4.90	6.50	8.90	11.70	14.60	16.60	16.40	14.10	10.60	7.10	4.20	(96)
------	------	------	------	-------	-------	-------	-------	-------	-------	------	------	------

Heat loss rate for mean internal temperature, Lm, W $[(39)m \times ((93)m - (96)m)]$

1911.76	1868.37	1712.91	1454.31	1138.46	767.62	496.71	520.89	812.52	1205.60	1580.42	1899.74	(97)
---------	---------	---------	---------	---------	--------	--------	--------	--------	---------	---------	---------	------

Space heating requirement, kWh/month $0.024 \times ((97)m - (95)m) \times (41)m$

946.15	766.49	676.16	431.17	237.14	0.00	0.00	0.00	0.00	416.12	693.24	960.56	(98)
$\sum(98)1...5, 10...12 =$											5127.03	

Space heating requirement kWh/m²/year

$(98) \div (4) =$ 37.24 (99)

9a. Energy requirements - individual heating systems including micro-CHP

Space heating

Fraction of space heat from secondary/supplementary system (table 11)

$=$ 0.00 (201)

Fraction of space heat from main system(s)

$1 - (201) =$ 1.00 (202)

Fraction of space heat from main system 2

$=$ 0.00 (202)

Fraction of total space heat from main system 1

$(202) \times [1 - (203)] =$ 1.00 (204)

Fraction of total space heat from main system 2

$(202) \times (203) =$ 0.00 (205)

Efficiency of main system 1 (%)

$=$ 93.00 (206)

	Jan	Feb	Mar	Apr	May	Jun	Jul	Aug	Sep	Oct	Nov	Dec	
Space heating fuel (main system 1), kWh/month	1017.37	824.18	727.05	463.62	254.99	0.00	0.00	0.00	0.00	447.44	745.42	1032.86	(211)
$\sum(211)1...5, 10...12 =$											5512.94		

Water heating

Efficiency of water heater

88.10	87.96	87.65	86.93	85.51	79.30	79.30	79.30	79.30	86.75	87.71	88.16	(217)
-------	-------	-------	-------	-------	-------	-------	-------	-------	-------	-------	-------	-------

Water heating fuel, kWh/month

204.40	180.47	191.32	175.86	176.89	172.67	168.96	182.84	181.66	184.03	189.21	199.74	(218)
--------	--------	--------	--------	--------	--------	--------	--------	--------	--------	--------	--------	-------

	$\Sigma(219a)1...12 =$	2208.06	(219)
Annual totals			
Space heating fuel - main system 1		5512.94	
Water heating fuel		2208.06	
Electricity for pumps, fans and electric keep-hot (Table 4f)			
central heating pump or water pump within warm air heating unit	30.00		(230c)
boiler flue fan	45.00		(230e)
Total electricity for the above, kWh/year		75.00	(231)
Electricity for lighting (Appendix L)		508.03	(232)
Total delivered energy for all uses	$(211)...(221) + (231) + (232)...(237b) =$	8304.02	(238)

Primary energy kWh/year	11209.51	(272)
Dwelling primary energy rate kWh/m2/year	81.42	(273)

10a. Fuel costs - individual heating systems including micro-CHP

	Fuel kWh/year		Fuel price		Fuel cost £/year	
Space heating - main system 1	5512.94	x	3.48	x 0.01 =	191.85	(240)
Water heating	2208.06	x	3.48	x 0.01 =	76.84	(247)
Pumps and fans	75.00	x	13.19	x 0.01 =	9.89	(249)
Electricity for lighting	508.03	x	13.19	x 0.01 =	67.01	(250)
Additional standing charges					120.00	(251)
Total energy cost				$(240)...(242) + (245)...(254) =$	465.59	(255)

11a. SAP rating - individual heating systems including micro-CHP

Energy cost deflator (Table 12)	0.42	(256)
Energy cost factor (ECF)	1.07	(257)
SAP value	85.07	
SAP rating (section 13)	85	(258)
SAP band	B	

12a. CO₂ emissions - individual heating systems including micro-CHP

	Energy kWh/year		Emission factor kg CO ₂ /kWh		Emissions kg CO ₂ /year	
Space heating - main system 1	5512.94	x	0.216	=	1190.79	(261)
Water heating	2208.06	x	0.216	=	476.94	(264)
Space and water heating				$(261) + (262) + (263) + (264) =$	1667.74	(265)
Pumps and fans	75.00	x	0.519	=	38.93	(267)
Electricity for lighting	508.03	x	0.519	=	263.67	(268)
Total CO ₂ , kg/year				$(265)...(271) =$	1970.33	(272)
Dwelling CO ₂ emission rate				$(272) \div (4) =$	14.31	(273)
EI value					85.55	
EI rating (section 14)					86	(274)
EI band					B	

13a. Primary energy - individual heating systems including micro-CHP

	Energy kWh/year		Primary factor		Primary Energy kWh/year	
Space heating - main system 1	5512.94	x	1.22	=	6725.78	(261)
Water heating	2208.06	x	1.22	=	2693.83	(264)
Space and water heating				$(261) + (262) + (263) + (264) =$	9419.62	(265)
Pumps and fans	75.00	x	3.07	=	230.25	(267)
Electricity for lighting	508.03	x	3.07	=	1559.64	(268)



This design submission has been carried out using Approved SAP software. It has been prepared from plans and specifications and may not reflect the property as constructed.

Assessor name	Mr Simon Gowing	Assessor number	9641
Client		Last modified	29/10/2018
Address	CALDWICK ALT - DET CALDER - DET, Bodicaote, OX15		

1. Overall dwelling dimensions

	Area (m ²)	Average storey height (m)	Volume (m ³)
Lowest occupied +1	82.46 (1a) x	2.39 (2a) =	197.08 (3a)
Total floor area	82.46 (1b) x	2.61 (2b) =	215.22 (3b)
Dwelling volume	(1a) + (1b) + (1c) + (1d)...(1n) = 164.92 (4)	(3a) + (3b) + (3c) + (3d)...(3n) =	412.30 (5)

2. Ventilation rate

		m ³ per hour
Number of chimneys	0 x 40 =	0 (6a)
Number of open flues	0 x 20 =	0 (6b)
Number of intermittent fans	6 x 10 =	60 (7a)
Number of passive vents	0 x 10 =	0 (7b)
Number of flueless gas fires	0 x 40 =	0 (7c)
Infiltration due to chimneys, flues, fans, PSVs	(6a) + (6b) + (7a) + (7b) + (7c) = 60 ÷ (5) =	0.15 (8)

If a pressurisation test has been carried out or is intended, proceed to (17), otherwise continue from (9) to (16)

Air permeability value, q50, expressed in cubic metres per hour per square metre of envelope area	5.00 (17)
If based on air permeability value, then (18) = [(17) ÷ 20] + (8), otherwise (18) = (16)	0.40 (18)
Number of sides on which the dwelling is sheltered	2 (19)
Shelter factor	1 - [0.075 x (19)] = 0.85 (20)
Infiltration rate incorporating shelter factor	(18) x (20) = 0.34 (21)

Infiltration rate modified for monthly wind speed:

	Jan	Feb	Mar	Apr	May	Jun	Jul	Aug	Sep	Oct	Nov	Dec
Monthly average wind speed from Table U2	5.10	5.00	4.90	4.40	4.30	3.80	3.80	3.70	4.00	4.30	4.50	4.70
Wind factor (22)m ÷ 4	1.28	1.25	1.23	1.10	1.08	0.95	0.95	0.93	1.00	1.08	1.13	1.18

Adjusted infiltration rate (allowing for shelter and wind factor) (21) x (22a)m	0.43	0.42	0.41	0.37	0.36	0.32	0.32	0.31	0.34	0.36	0.38	0.40
---	------	------	------	------	------	------	------	------	------	------	------	------

Calculate effective air change rate for the applicable case:	
If mechanical ventilation: air change rate through system	N/A (23a)
If balanced with heat recovery: efficiency in % allowing for in-use factor from Table 4h	N/A (23c)
d) natural ventilation or whole house positive input ventilation from loft	0.59 0.59 0.58 0.57 0.57 0.55 0.55 0.55 0.56 0.57 0.57 0.58 (24d)

Effective air change rate - enter (24a) or (24b) or (24c) or (24d) in (25)	0.59 0.59 0.58 0.57 0.57 0.55 0.55 0.55 0.56 0.57 0.57 0.58 (25)
--	--

Effective air change rate - enter (24a) or (24b) or (24c) or (24d) in (25)	0.59 0.59 0.58 0.57 0.57 0.55 0.55 0.55 0.56 0.57 0.57 0.58 (25)
--	--

Effective air change rate - enter (24a) or (24b) or (24c) or (24d) in (25)	0.59 0.59 0.58 0.57 0.57 0.55 0.55 0.55 0.56 0.57 0.57 0.58 (25)
--	--

0.59	0.59	0.58	0.57	0.57	0.55	0.55	0.55	0.56	0.57	0.57	0.58
------	------	------	------	------	------	------	------	------	------	------	------

3. Heat losses and heat loss parameter

Element	Gross area, m ²	Openings m ²	Net area A, m ²	U-value W/m ² K	A x U W/K	k-value, kJ/m ² .K	A x k, kJ/K
Window			35.37	1.15	40.50		
Door			2.00	1.30	2.60		
Ground floor			82.46	0.16	13.19		
External wall			173.73	0.20	34.75		
Roof			82.46	0.11	9.07		
Total area of external elements ΣA, m ²			376.02				
Fabric heat loss, W/K = Σ(A x U)						(26)...(30) + (32) =	100.11 (33)
Heat capacity Cm = Σ(A x k)						(28)...(30) + (32) + (32a)...(32e) =	N/A (34)
Thermal mass parameter (TMP) in kJ/m ² K							100.00 (35)
Thermal bridges: Σ(L x Ψ) calculated using Appendix K							15.04 (36)
Total fabric heat loss						(33) + (36) =	115.15 (37)

	Jan	Feb	Mar	Apr	May	Jun	Jul	Aug	Sep	Oct	Nov	Dec
Ventilation heat loss calculated monthly 0.33 x (25)m x (5)	80.53	80.04	79.57	77.33	76.92	74.97	74.97	74.61	75.72	76.92	77.76	78.65

Heat transfer coefficient, W/K (37)m + (38)m	195.68	195.20	194.72	192.49	192.07	190.12	190.12	189.76	190.87	192.07	192.91	193.80
Average = Σ(39)1...12/12 =	192.48 (39)											

Heat loss parameter (HLP), W/m ² K (39)m ÷ (4)	1.19	1.18	1.18	1.17	1.16	1.15	1.15	1.15	1.16	1.16	1.17	1.18
Average = Σ(40)1...12/12 =	1.17 (40)											

Number of days in month (Table 1a)	31.00	28.00	31.00	30.00	31.00	30.00	31.00	31.00	30.00	31.00	30.00	31.00
------------------------------------	-------	-------	-------	-------	-------	-------	-------	-------	-------	-------	-------	-------

4. Water heating energy requirement

Assumed occupancy, N	2.96 (42)
Annual average hot water usage in litres per day Vd,average = (25 x N) + 36	104.40 (43)

	Jan	Feb	Mar	Apr	May	Jun	Jul	Aug	Sep	Oct	Nov	Dec
Hot water usage in litres per day for each month Vd,m = factor from Table 1c x (43)	114.84	110.66	106.49	102.31	98.13	93.96	93.96	98.13	102.31	106.49	110.66	114.84
Σ(44)1...12 =	1252.78 (44)											

Energy content of hot water used = 4.18 x Vd,m x nm x Tm/3600 kWh/month (see Tables 1b, 1c 1d)	170.30	148.95	153.70	134.00	128.58	110.95	102.81	117.98	119.39	139.13	151.88	164.93
Σ(45)1...12 =	1642.59 (45)											

Distribution loss 0.15 x (45)m	25.55	22.34	23.05	20.10	19.29	16.64	15.42	17.70	17.91	20.87	22.78	24.74
Storage volume (litres) including any solar or WWHRs storage within same vessel	250.00 (47)											

Water storage loss:	
a) If manufacturer's declared loss factor is known (kWh/day)	1.67 (48)
Temperature factor from Table 2b	0.54 (49)
Energy lost from water storage (kWh/day) (48) x (49)	0.90 (50)
Enter (50) or (54) in (55)	0.90 (55)

Water storage loss calculated for each month (55) x (41)m	27.96	25.25	27.96	27.05	27.96	27.05	27.96	27.96	27.05	27.96	27.05	27.96
If the vessel contains dedicated solar storage or dedicated WWHRs (56)m x [(47) - Vs] ÷ (47), else (56)												

27.96	25.25	27.96	27.05	27.96	27.05	27.96	27.96	27.05	27.96	27.05	27.96	(57)
-------	-------	-------	-------	-------	-------	-------	-------	-------	-------	-------	-------	------

Primary circuit loss for each month from Table 3

23.26	21.01	23.26	22.51	23.26	22.51	23.26	23.26	22.51	23.26	22.51	23.26	(59)
-------	-------	-------	-------	-------	-------	-------	-------	-------	-------	-------	-------	------

Combi loss for each month from Table 3a, 3b or 3c

0.00	0.00	0.00	0.00	0.00	0.00	0.00	0.00	0.00	0.00	0.00	0.00	(61)
------	------	------	------	------	------	------	------	------	------	------	------	------

Total heat required for water heating calculated for each month 0.85 x (45)m + (46)m + (57)m + (59)m + (61)m

221.52	195.21	204.92	183.57	179.79	160.52	154.03	169.20	168.95	190.35	201.44	216.15	(62)
--------	--------	--------	--------	--------	--------	--------	--------	--------	--------	--------	--------	------

Solar DHW input calculated using Appendix G or Appendix H

-40.29	-35.45	-36.18	-29.76	-27.62	-22.78	-19.28	-23.34	-24.03	-29.71	-34.42	-38.94	(63)
--------	--------	--------	--------	--------	--------	--------	--------	--------	--------	--------	--------	------

Output from water heater for each month (kWh/month) (62)m + (63)m

181.23	159.76	168.74	153.81	152.17	137.73	134.75	145.86	144.93	160.65	167.02	177.21	(64)
$\Sigma(64)1...12 =$											1883.85	

Heat gains from water heating (kWh/month) 0.25 x [0.85 x (45)m + (61)m] + 0.8 x [(46)m + (57)m + (59)m]

97.60	86.53	92.08	84.21	83.73	76.54	75.16	80.20	79.35	87.24	90.15	95.81	(65)
-------	-------	-------	-------	-------	-------	-------	-------	-------	-------	-------	-------	------

5. Internal gains

	Jan	Feb	Mar	Apr	May	Jun	Jul	Aug	Sep	Oct	Nov	Dec	
--	-----	-----	-----	-----	-----	-----	-----	-----	-----	-----	-----	-----	--

Metabolic gains (Table 5)

147.79	147.79	147.79	147.79	147.79	147.79	147.79	147.79	147.79	147.79	147.79	147.79	147.79	(66)
--------	--------	--------	--------	--------	--------	--------	--------	--------	--------	--------	--------	--------	------

Lighting gains (calculated in Appendix L, equation L9 or L9a), also see Table 5

30.03	26.67	21.69	16.42	12.27	10.36	11.20	14.55	19.53	24.80	28.95	30.86	(67)
-------	-------	-------	-------	-------	-------	-------	-------	-------	-------	-------	-------	------

Appliance gains (calculated in Appendix L, equation L13 or L13a), also see Table 5

336.33	339.82	331.03	312.30	288.67	266.46	251.62	248.13	256.92	275.64	299.28	321.49	(68)
--------	--------	--------	--------	--------	--------	--------	--------	--------	--------	--------	--------	------

Cooking gains (calculated in Appendix L, equation L15 or L15a), also see Table 5

37.78	37.78	37.78	37.78	37.78	37.78	37.78	37.78	37.78	37.78	37.78	37.78	(69)
-------	-------	-------	-------	-------	-------	-------	-------	-------	-------	-------	-------	------

Pump and fan gains (Table 5a)

3.00	3.00	3.00	3.00	3.00	3.00	3.00	3.00	3.00	3.00	3.00	3.00	(70)
------	------	------	------	------	------	------	------	------	------	------	------	------

Losses e.g. evaporation (Table 5)

-118.23	-118.23	-118.23	-118.23	-118.23	-118.23	-118.23	-118.23	-118.23	-118.23	-118.23	-118.23	(71)
---------	---------	---------	---------	---------	---------	---------	---------	---------	---------	---------	---------	------

Water heating gains (Table 5)

131.18	128.77	123.76	116.95	112.53	106.31	101.02	107.80	110.21	117.25	125.21	128.78	(72)
--------	--------	--------	--------	--------	--------	--------	--------	--------	--------	--------	--------	------

Total internal gains (66)m + (67)m + (68)m + (69)m + (70)m + (71)m + (72)m

567.88	565.60	546.82	516.01	483.81	453.47	434.17	440.81	457.00	488.04	523.78	551.47	(73)
--------	--------	--------	--------	--------	--------	--------	--------	--------	--------	--------	--------	------

6. Solar gains

	Access factor Table 6d	Area m ²	Solar flux W/m ²	g specific data or Table 6b	FF specific data or Table 6c	Gains W	
--	---------------------------	------------------------	--------------------------------	-----------------------------------	------------------------------------	------------	--

SouthWest $0.77 \times 9.01 \times 36.79 \times 0.9 \times 0.63 \times 0.70 = 101.31$ (79)

SouthEast $0.77 \times 3.93 \times 36.79 \times 0.9 \times 0.63 \times 0.70 = 44.19$ (77)

NorthEast $0.77 \times 15.73 \times 11.28 \times 0.9 \times 0.63 \times 0.70 = 54.24$ (75)

NorthWest $0.77 \times 6.70 \times 11.28 \times 0.9 \times 0.63 \times 0.70 = 23.10$ (81)

Solar gains in watts $\Sigma(74)m... (82)m$

222.85	405.29	622.77	886.02	1096.81	1134.80	1074.96	910.68	712.82	466.33	271.60	187.69	(83)
--------	--------	--------	--------	---------	---------	---------	--------	--------	--------	--------	--------	------

Total gains - internal and solar (73)m + (83)m

790.73	970.88	1169.58	1402.03	1580.63	1588.27	1509.13	1351.49	1169.82	954.36	795.38	739.16	(84)
--------	--------	---------	---------	---------	---------	---------	---------	---------	--------	--------	--------	------

7. Mean internal temperature (heating season)

Temperature during heating periods in the living area from Table 9, Th1(°C) 21.00 (85)

	Jan	Feb	Mar	Apr	May	Jun	Jul	Aug	Sep	Oct	Nov	Dec	
--	-----	-----	-----	-----	-----	-----	-----	-----	-----	-----	-----	-----	--

Utilisation factor for gains for living area n1,m (see Table 9a)

0.98	0.97	0.94	0.87	0.76	0.62	0.49	0.55	0.76	0.92	0.97	0.98	(86)
------	------	------	------	------	------	------	------	------	------	------	------	------

Mean internal temp of living area T1 (steps 3 to 7 in Table 9c)

18.33	18.64	19.15	19.81	20.38	20.75	20.90	20.87	20.54	19.79	18.94	18.28	(87)
-------	-------	-------	-------	-------	-------	-------	-------	-------	-------	-------	-------	------

Temperature during heating periods in the rest of dwelling from Table 9, Th2(°C)

19.93	19.93	19.94	19.95	19.95	19.96	19.96	19.96	19.95	19.95	19.94	19.94	(88)
-------	-------	-------	-------	-------	-------	-------	-------	-------	-------	-------	-------	------

Utilisation factor for gains for rest of dwelling n2,m

0.98	0.96	0.93	0.85	0.72	0.55	0.40	0.46	0.71	0.90	0.96	0.98	(89)
------	------	------	------	------	------	------	------	------	------	------	------	------

Mean internal temperature in the rest of dwelling T2 (follow steps 3 to 7 in Table 9c)

16.35	16.79	17.53	18.47	19.25	19.73	19.89	19.86	19.49	18.47	17.25	16.28	(90)
-------	-------	-------	-------	-------	-------	-------	-------	-------	-------	-------	-------	------

Living area fraction

Living area ÷ (4) = 0.17 (91)

Mean internal temperature for the whole dwelling fLA x T1 + (1 - fLA) x T2

16.68	17.10	17.80	18.70	19.44	19.90	20.06	20.03	19.67	18.69	17.53	16.62	(92)
-------	-------	-------	-------	-------	-------	-------	-------	-------	-------	-------	-------	------

Apply adjustment to the mean internal temperature from Table 4e where appropriate

16.53	16.95	17.65	18.55	19.29	19.75	19.91	19.88	19.52	18.54	17.38	16.47	(93)
-------	-------	-------	-------	-------	-------	-------	-------	-------	-------	-------	-------	------

8. Space heating requirement

	Jan	Feb	Mar	Apr	May	Jun	Jul	Aug	Sep	Oct	Nov	Dec	
--	-----	-----	-----	-----	-----	-----	-----	-----	-----	-----	-----	-----	--

Utilisation factor for gains, ηm

0.96	0.94	0.89	0.81	0.69	0.54	0.39	0.45	0.68	0.86	0.94	0.97	(94)
------	------	------	------	------	------	------	------	------	------	------	------	------

Useful gains, ηmGm, W (94)m x (84)m

759.05	909.33	1045.80	1140.54	1093.17	850.27	590.37	604.24	791.24	824.05	748.64	713.64	(95)
--------	--------	---------	---------	---------	--------	--------	--------	--------	--------	--------	--------	------

Monthly average external temperature from Table U1

4.30	4.90	6.50	8.90	11.70	14.60	16.60	16.40	14.10	10.60	7.10	4.20	(96)
------	------	------	------	-------	-------	-------	-------	-------	-------	------	------	------

Heat loss rate for mean internal temperature, Lm, W [(39)m x [(93)m - (96)m]

2393.28	2352.41	2170.99	1856.86	1457.46	979.29	629.64	660.68	1034.08	1524.77	1983.34	2377.23	(97)
---------	---------	---------	---------	---------	--------	--------	--------	---------	---------	---------	---------	------

Space heating requirement, kWh/month 0.024 x [(97)m - (95)m] x (41)m

1215.87	969.75	837.14	515.75	271.03	0.00	0.00	0.00	521.34	888.99	1237.71		(98)
$\Sigma(98)1...5, 10...12 =$											6457.57	

Space heating requirement kWh/m²/year

(98) ÷ (4) = 39.16 (99)

9a. Energy requirements - individual heating systems including micro-CHP

Space heating

Fraction of space heat from secondary/supplementary system (table 11) 0.00 (201)

Fraction of space heat from main system(s) 1 - (201) = 1.00 (202)

Fraction of space heat from main system 2 0.00 (202)

Fraction of total space heat from main system 1 (202) x [1 - (203)] = 1.00 (204)

Fraction of total space heat from main system 2 (202) x (203) = 0.00 (205)

Efficiency of main system 1 (%) 93.00 (206)

	Jan	Feb	Mar	Apr	May	Jun	Jul	Aug	Sep	Oct	Nov	Dec	
--	-----	-----	-----	-----	-----	-----	-----	-----	-----	-----	-----	-----	--

Space heating fuel (main system 1), kWh/month

1307.38	1042.74	900.15	554.57	291.43	0.00	0.00	0.00	0.00	560.58	955.90	1330.87	(211)
$\Sigma(211)1...5, 10...12 =$											6943.63	

Water heating

Efficiency of water heater 88.45 (217)

Water heating fuel, kWh/month

204.90	180.90	191.73	176.20	177.28	173.69	169.93	183.93	182.76	184.17	189.54	200.22	
Σ(219a)1...12 =											2215.23	(219)

Annual totals

Space heating fuel - main system 1		6943.63	
Water heating fuel		2215.23	
Electricity for pumps, fans and electric keep-hot (Table 4f)			
central heating pump or water pump within warm air heating unit	30.00		(230c)
boiler flue fan	45.00		(230e)
Total electricity for the above, kWh/year		75.00	(231)
Electricity for lighting (Appendix L)		530.29	(232)
Total delivered energy for all uses	(211)...(221) + (231) + (232)...(237b) =	9764.15	(238)

10a. Fuel costs - individual heating systems including micro-CHP

	Fuel kWh/year		Fuel price		Fuel cost £/year	
Space heating - main system 1	6943.63	x	3.48	x 0.01 =	241.64	(240)
Water heating	2215.23	x	3.48	x 0.01 =	77.09	(247)
Pumps and fans	75.00	x	13.19	x 0.01 =	9.89	(249)
Electricity for lighting	530.29	x	13.19	x 0.01 =	69.95	(250)
Additional standing charges					120.00	(251)
Total energy cost				(240)...(242) + (245)...(254) =	518.57	(255)

11a. SAP rating - individual heating systems including micro-CHP

Energy cost deflator (Table 12)	0.42	(256)
Energy cost factor (ECF)	1.04	(257)
SAP value	85.53	
SAP rating (section 13)	86	(258)
SAP band	B	

12a. CO₂ emissions - individual heating systems including micro-CHP

	Energy kWh/year		Emission factor kg CO ₂ /kWh		Emissions kg CO ₂ /year	
Space heating - main system 1	6943.63	x	0.216	=	1499.82	(261)
Water heating	2215.23	x	0.216	=	478.49	(264)
Space and water heating				(261) + (262) + (263) + (264) =	1978.31	(265)
Pumps and fans	75.00	x	0.519	=	38.93	(267)
Electricity for lighting	530.29	x	0.519	=	275.22	(268)
Total CO ₂ , kg/year				(265)...(271) =	2292.46	(272)
Dwelling CO ₂ emission rate				(272) ÷ (4) =	13.90	(273)
EI value					85.37	
EI rating (section 14)					85	(274)
EI band					B	

13a. Primary energy - individual heating systems including micro-CHP

	Energy kWh/year		Primary factor		Primary Energy kWh/year	
Space heating - main system 1	6943.63	x	1.22	=	8471.23	(261)
Water heating	2215.23	x	1.22	=	2702.59	(264)
Space and water heating				(261) + (262) + (263) + (264) =	11173.81	(265)
Pumps and fans	75.00	x	3.07	=	230.25	(267)

Electricity for lighting	530.29	x	3.07	=	1628.00	(268)
Primary energy kWh/year					13032.06	(272)
Dwelling primary energy rate kWh/m ² /year					79.02	(273)

This design submission has been carried out using Approved SAP software. It has been prepared from plans and specifications and may not reflect the property as constructed.

Assessor name	Mr Simon Gowing	Assessor number	9641
Client		Last modified	29/10/2018
Address	GF 1B Oxford Road, Bodicaote, OX15		

1. Overall dwelling dimensions

	Area (m ²)	Average storey height (m)	Volume (m ³)
Lowest occupied	<input type="text" value="43.62"/> (1a) x	<input type="text" value="2.39"/> (2a) =	<input type="text" value="104.25"/> (3a)
Total floor area	(1a) + (1b) + (1c) + (1d)...(1n) = <input type="text" value="43.62"/> (4)		
Dwelling volume	(3a) + (3b) + (3c) + (3d)...(3n) = <input type="text" value="104.25"/> (5)		

2. Ventilation rate

		m ³ per hour
Number of chimneys	<input type="text" value="0"/> x 40 =	<input type="text" value="0"/> (6a)
Number of open flues	<input type="text" value="0"/> x 20 =	<input type="text" value="0"/> (6b)
Number of intermittent fans	<input type="text" value="0"/> x 10 =	<input type="text" value="0"/> (7a)
Number of passive vents	<input type="text" value="0"/> x 10 =	<input type="text" value="0"/> (7b)
Number of flueless gas fires	<input type="text" value="0"/> x 40 =	<input type="text" value="0"/> (7c)

	Air changes per hour
Infiltration due to chimneys, flues, fans, PSVs	(6a) + (6b) + (7a) + (7b) + (7c) = <input type="text" value="0"/> ÷ (5) = <input type="text" value="0.00"/> (8)

If a pressurisation test has been carried out or is intended, proceed to (17), otherwise continue from (9) to (16)

Air permeability value, q ₅₀ , expressed in cubic metres per hour per square metre of envelope area	<input type="text" value="4.00"/> (17)
If based on air permeability value, then (18) = [(17) ÷ 20] + (8), otherwise (18) = (16)	<input type="text" value="0.20"/> (18)
Number of sides on which the dwelling is sheltered	<input type="text" value="1"/> (19)
Shelter factor	1 - [0.075 x (19)] = <input type="text" value="0.93"/> (20)
Infiltration rate incorporating shelter factor	(18) x (20) = <input type="text" value="0.19"/> (21)

Infiltration rate modified for monthly wind speed:

	Jan	Feb	Mar	Apr	May	Jun	Jul	Aug	Sep	Oct	Nov	Dec
Monthly average wind speed from Table U2	<input type="text" value="5.10"/>	<input type="text" value="5.00"/>	<input type="text" value="4.90"/>	<input type="text" value="4.40"/>	<input type="text" value="4.30"/>	<input type="text" value="3.80"/>	<input type="text" value="3.80"/>	<input type="text" value="3.70"/>	<input type="text" value="4.00"/>	<input type="text" value="4.30"/>	<input type="text" value="4.50"/>	<input type="text" value="4.70"/> (22)

Wind factor (22)m ÷ 4	<input type="text" value="1.28"/>	<input type="text" value="1.25"/>	<input type="text" value="1.23"/>	<input type="text" value="1.10"/>	<input type="text" value="1.08"/>	<input type="text" value="0.95"/>	<input type="text" value="0.95"/>	<input type="text" value="0.93"/>	<input type="text" value="1.00"/>	<input type="text" value="1.08"/>	<input type="text" value="1.13"/>	<input type="text" value="1.18"/> (22a)
-----------------------	-----------------------------------	-----------------------------------	-----------------------------------	-----------------------------------	-----------------------------------	-----------------------------------	-----------------------------------	-----------------------------------	-----------------------------------	-----------------------------------	-----------------------------------	---

Adjusted infiltration rate (allowing for shelter and wind factor) (21) x (22a)m	<input type="text" value="0.24"/>	<input type="text" value="0.23"/>	<input type="text" value="0.23"/>	<input type="text" value="0.20"/>	<input type="text" value="0.20"/>	<input type="text" value="0.18"/>	<input type="text" value="0.18"/>	<input type="text" value="0.17"/>	<input type="text" value="0.19"/>	<input type="text" value="0.20"/>	<input type="text" value="0.21"/>	<input type="text" value="0.22"/> (22b)
---	-----------------------------------	-----------------------------------	-----------------------------------	-----------------------------------	-----------------------------------	-----------------------------------	-----------------------------------	-----------------------------------	-----------------------------------	-----------------------------------	-----------------------------------	---

Calculate effective air change rate for the applicable case:

If mechanical ventilation: air change rate through system (23a)

If balanced with heat recovery: efficiency in % allowing for in-use factor from Table 4h (23c)

c) whole house extract ventilation or positive input ventilation from outside	<input type="text" value="0.50"/>	<input type="text" value="0.50"/>	<input type="text" value="0.50"/>	<input type="text" value="0.50"/>	<input type="text" value="0.50"/>	<input type="text" value="0.50"/>	<input type="text" value="0.50"/>	<input type="text" value="0.50"/>	<input type="text" value="0.50"/>	<input type="text" value="0.50"/>	<input type="text" value="0.50"/>	<input type="text" value="0.50"/> (24c)
---	-----------------------------------	-----------------------------------	-----------------------------------	-----------------------------------	-----------------------------------	-----------------------------------	-----------------------------------	-----------------------------------	-----------------------------------	-----------------------------------	-----------------------------------	---

Effective air change rate - enter (24a) or (24b) or (24c) or (24d) in (25)	<input type="text" value="0.50"/>	<input type="text" value="0.50"/>	<input type="text" value="0.50"/>	<input type="text" value="0.50"/>	<input type="text" value="0.50"/>	<input type="text" value="0.50"/>	<input type="text" value="0.50"/>	<input type="text" value="0.50"/>	<input type="text" value="0.50"/>	<input type="text" value="0.50"/>	<input type="text" value="0.50"/>	<input type="text" value="0.50"/> (25)
--	-----------------------------------	-----------------------------------	-----------------------------------	-----------------------------------	-----------------------------------	-----------------------------------	-----------------------------------	-----------------------------------	-----------------------------------	-----------------------------------	-----------------------------------	--

3. Heat losses and heat loss parameter

Element	Gross area, m ²	Openings m ²	Net area A, m ²	U-value W/m ² K	A x U W/K	k-value, kJ/m ² .K	A x k, kJ/K
Window	<input type="text" value="7.15"/>	<input type="text" value="1.24"/>	<input type="text" value="8.84"/>	<input type="text" value="0.95"/>	<input type="text" value="8.84"/>		<input type="text" value="8.84"/> (27)
Door	<input type="text" value="2.22"/>	<input type="text" value="1.30"/>	<input type="text" value="2.89"/>	<input type="text" value="0.95"/>	<input type="text" value="2.89"/>		<input type="text" value="2.89"/> (26)
Ground floor	<input type="text" value="43.62"/>	<input type="text" value="0.17"/>	<input type="text" value="7.42"/>	<input type="text" value="0.17"/>	<input type="text" value="7.42"/>		<input type="text" value="7.42"/> (28a)
External wall	<input type="text" value="43.43"/>	<input type="text" value="0.20"/>	<input type="text" value="8.69"/>	<input type="text" value="0.20"/>	<input type="text" value="8.69"/>		<input type="text" value="8.69"/> (29a)
Party wall	<input type="text" value="17.40"/>	<input type="text" value="0.00"/>	<input type="text" value="0.00"/>	<input type="text" value="0.00"/>	<input type="text" value="0.00"/>		<input type="text" value="0.00"/> (32)
Total area of external elements ΣA, m ²			<input type="text" value="96.42"/>				<input type="text" value="96.42"/> (31)
Fabric heat loss, W/K = Σ(A x U)						(26)...(30) + (32) =	<input type="text" value="27.82"/> (33)
Heat capacity Cm = Σ(A x k)						(28)...(30) + (32) + (32a)...(32e) =	<input type="text" value="N/A"/> (34)
Thermal mass parameter (TMP) in kJ/m ² K							<input type="text" value="194.00"/> (35)
Thermal bridges: Σ(L x Ψ) calculated using Appendix K							<input type="text" value="5.81"/> (36)
Total fabric heat loss						(33) + (36) =	<input type="text" value="33.64"/> (37)
Ventilation heat loss calculated monthly 0.33 x (25)m x (5)	<input type="text" value="17.20"/>	<input type="text" value="17.20"/>	<input type="text" value="17.20"/>	<input type="text" value="17.20"/>	<input type="text" value="17.20"/>	<input type="text" value="17.20"/>	<input type="text" value="17.20"/>
Heat transfer coefficient, W/K (37)m + (38)m	<input type="text" value="50.84"/>	<input type="text" value="50.84"/>	<input type="text" value="50.84"/>	<input type="text" value="50.84"/>	<input type="text" value="50.84"/>	<input type="text" value="50.84"/>	<input type="text" value="50.84"/>
Average = Σ(39)1...12/12 =							<input type="text" value="50.84"/> (39)
Heat loss parameter (HLP), W/m ² K (39)m ÷ (4)	<input type="text" value="1.17"/>	<input type="text" value="1.17"/>	<input type="text" value="1.17"/>	<input type="text" value="1.17"/>	<input type="text" value="1.17"/>	<input type="text" value="1.17"/>	<input type="text" value="1.17"/>
Average = Σ(40)1...12/12 =							<input type="text" value="1.17"/> (40)
Number of days in month (Table 1a)	<input type="text" value="31.00"/>	<input type="text" value="28.00"/>	<input type="text" value="31.00"/>	<input type="text" value="30.00"/>	<input type="text" value="31.00"/>	<input type="text" value="30.00"/>	<input type="text" value="31.00"/>

4. Water heating energy requirement

Assumed occupancy, N	<input type="text" value="1.51"/> (42)											
Annual average hot water usage in litres per day V _{d,average} = (25 x N) + 36	<input type="text" value="69.96"/> (43)											
Hot water usage in litres per day for each month V _{d,m} = factor from Table 1c x (43)	<input type="text" value="76.95"/>	<input type="text" value="74.15"/>	<input type="text" value="71.36"/>	<input type="text" value="68.56"/>	<input type="text" value="65.76"/>	<input type="text" value="62.96"/>	<input type="text" value="62.96"/>	<input type="text" value="65.76"/>	<input type="text" value="68.56"/>	<input type="text" value="71.36"/>	<input type="text" value="74.15"/>	<input type="text" value="76.95"/>
Σ(44)1...12 =	<input type="text" value="839.48"/> (44)											
Energy content of hot water used = 4.18 x V _{d,m} x nm x T _m /3600 kWh/month (see Tables 1b, 1c 1d)	<input type="text" value="114.12"/>	<input type="text" value="99.81"/>	<input type="text" value="102.99"/>	<input type="text" value="89.79"/>	<input type="text" value="86.16"/>	<input type="text" value="74.35"/>	<input type="text" value="68.89"/>	<input type="text" value="79.06"/>	<input type="text" value="80.00"/>	<input type="text" value="93.23"/>	<input type="text" value="101.77"/>	<input type="text" value="110.52"/>
Σ(45)1...12 =	<input type="text" value="1100.68"/> (45)											
Distribution loss 0.15 x (45)m	<input type="text" value="17.12"/>	<input type="text" value="14.97"/>	<input type="text" value="15.45"/>	<input type="text" value="13.47"/>	<input type="text" value="12.92"/>	<input type="text" value="11.15"/>	<input type="text" value="10.33"/>	<input type="text" value="11.86"/>	<input type="text" value="12.00"/>	<input type="text" value="13.98"/>	<input type="text" value="15.27"/>	<input type="text" value="16.58"/> (46)
Water storage loss calculated for each month (55) x (41)m	<input type="text" value="0.00"/>	<input type="text" value="0.00"/>	<input type="text" value="0.00"/>	<input type="text" value="0.00"/>	<input type="text" value="0.00"/>	<input type="text" value="0.00"/>	<input type="text" value="0.00"/>	<input type="text" value="0.00"/>	<input type="text" value="0.00"/>	<input type="text" value="0.00"/>	<input type="text" value="0.00"/>	<input type="text" value="0.00"/> (56)
If the vessel contains dedicated solar storage or dedicated WWHRS (56)m x [(47) - Vs] ÷ (47), else (56)	<input type="text" value="0.00"/>	<input type="text" value="0.00"/>	<input type="text" value="0.00"/>	<input type="text" value="0.00"/>	<input type="text" value="0.00"/>	<input type="text" value="0.00"/>	<input type="text" value="0.00"/>	<input type="text" value="0.00"/>	<input type="text" value="0.00"/>	<input type="text" value="0.00"/>	<input type="text" value="0.00"/>	<input type="text" value="0.00"/> (57)
Primary circuit loss for each month from Table 3	<input type="text" value="0.00"/>	<input type="text" value="0.00"/>	<input type="text" value="0.00"/>	<input type="text" value="0.00"/>	<input type="text" value="0.00"/>	<input type="text" value="0.00"/>	<input type="text" value="0.00"/>	<input type="text" value="0.00"/>	<input type="text" value="0.00"/>	<input type="text" value="0.00"/>	<input type="text" value="0.00"/>	<input type="text" value="0.00"/> (59)
Combi loss for each month from Table 3a, 3b or 3c	<input type="text" value="21.54"/>	<input type="text" value="19.43"/>	<input type="text" value="21.47"/>	<input type="text" value="20.74"/>	<input type="text" value="21.40"/>	<input type="text" value="20.67"/>	<input type="text" value="21.34"/>	<input type="text" value="21.38"/>	<input type="text" value="20.71"/>	<input type="text" value="21.44"/>	<input type="text" value="20.80"/>	<input type="text" value="21.52"/> (61)
Total heat required for water heating calculated for each month 0.85 x (45)m + (46)m + (57)m + (59)m + (61)m	<input type="text" value="135.65"/>	<input type="text" value="119.24"/>	<input type="text" value="124.47"/>	<input type="text" value="110.53"/>	<input type="text" value="107.56"/>	<input type="text" value="95.02"/>	<input type="text" value="90.23"/>	<input type="text" value="100.43"/>	<input type="text" value="100.71"/>	<input type="text" value="114.68"/>	<input type="text" value="122.57"/>	<input type="text" value="132.04"/> (62)

Solar DHW input calculated using Appendix G or Appendix H

-32.73	-28.79	-29.39	-24.24	-22.54	-18.62	-15.80	-19.12	-19.66	-24.25	-28.03	-31.62	(63)
--------	--------	--------	--------	--------	--------	--------	--------	--------	--------	--------	--------	------

Output from water heater for each month (kWh/month) (62)m + (63)m

102.92	90.44	95.08	86.29	85.01	76.40	74.43	81.32	81.05	90.42	94.54	100.42	(64)
$\Sigma(64)1...12 =$											1058.32	

Heat gains from water heating (kWh/month) $0.25 \times [0.85 \times (45)m + (61)m] + 0.8 \times [(46)m + (57)m + (59)m]$

43.33	38.04	39.61	35.04	34.00	29.89	28.24	31.63	31.78	36.36	39.04	42.13	(65)
-------	-------	-------	-------	-------	-------	-------	-------	-------	-------	-------	-------	------

5. Internal gains

Metabolic gains (Table 5)

75.28	75.28	75.28	75.28	75.28	75.28	75.28	75.28	75.28	75.28	75.28	75.28	(66)
-------	-------	-------	-------	-------	-------	-------	-------	-------	-------	-------	-------	------

Lighting gains (calculated in Appendix L, equation L9 or L9a), also see Table 5

12.10	10.75	8.74	6.62	4.95	4.18	4.51	5.87	7.87	10.00	11.67	12.44	(67)
-------	-------	------	------	------	------	------	------	------	-------	-------	-------	------

Appliance gains (calculated in Appendix L, equation L13 or L13a), also see Table 5

130.73	132.09	128.67	121.39	112.21	103.57	97.80	96.45	99.87	107.14	116.33	124.96	(68)
--------	--------	--------	--------	--------	--------	-------	-------	-------	--------	--------	--------	------

Cooking gains (calculated in Appendix L, equation L15 or L15a), also see Table 5

30.53	30.53	30.53	30.53	30.53	30.53	30.53	30.53	30.53	30.53	30.53	30.53	(69)
-------	-------	-------	-------	-------	-------	-------	-------	-------	-------	-------	-------	------

Pump and fan gains (Table 5a)

3.00	3.00	3.00	3.00	3.00	3.00	3.00	3.00	3.00	3.00	3.00	3.00	(70)
------	------	------	------	------	------	------	------	------	------	------	------	------

Losses e.g. evaporation (Table 5)

-60.22	-60.22	-60.22	-60.22	-60.22	-60.22	-60.22	-60.22	-60.22	-60.22	-60.22	-60.22	(71)
--------	--------	--------	--------	--------	--------	--------	--------	--------	--------	--------	--------	------

Water heating gains (Table 5)

58.24	56.61	53.24	48.67	45.69	41.51	37.96	42.51	44.14	48.87	54.22	56.62	(72)
-------	-------	-------	-------	-------	-------	-------	-------	-------	-------	-------	-------	------

Total internal gains (66)m + (67)m + (68)m + (69)m + (70)m + (71)m + (72)m

249.66	248.03	239.24	225.26	211.43	197.84	188.86	193.41	200.46	214.60	230.80	242.61	(73)
--------	--------	--------	--------	--------	--------	--------	--------	--------	--------	--------	--------	------

6. Solar gains

Access factor Table 6d, Area m², Solar flux W/m², g specific data or Table 6b, FF specific data or Table 6c, Gains W

NorthWest	0.77	x	1.70	x	11.28	x 0.9 x	0.63	x	0.70	=	5.86	(81)
NorthEast	0.77	x	1.66	x	11.28	x 0.9 x	0.63	x	0.70	=	5.72	(75)
SouthEast	0.77	x	3.79	x	36.79	x 0.9 x	0.63	x	0.70	=	42.62	(77)

Solar gains in watts $\Sigma(74)m... (82)m$

54.20	96.18	141.82	192.85	231.65	236.85	225.49	195.49	159.32	109.05	65.62	45.93	(83)
-------	-------	--------	--------	--------	--------	--------	--------	--------	--------	-------	-------	------

Total gains - internal and solar (73)m + (83)m

303.86	344.21	381.05	418.11	443.08	434.69	414.35	388.90	359.78	323.65	296.43	288.54	(84)
--------	--------	--------	--------	--------	--------	--------	--------	--------	--------	--------	--------	------

7. Mean internal temperature (heating season)

Temperature during heating periods in the living area from Table 9, Th1(°C) 21.00 (85)

Jan	Feb	Mar	Apr	May	Jun	Jul	Aug	Sep	Oct	Nov	Dec
-----	-----	-----	-----	-----	-----	-----	-----	-----	-----	-----	-----

Utilisation factor for gains for living area n1,m (see Table 9a)

0.99	0.98	0.97	0.92	0.83	0.67	0.52	0.57	0.79	0.94	0.98	0.99	(86)
------	------	------	------	------	------	------	------	------	------	------	------	------

Mean internal temp of living area T1 (steps 3 to 7 in Table 9c)

19.57	19.75	20.04	20.40	20.72	20.92	20.98	20.97	20.83	20.42	19.92	19.52	(87)
-------	-------	-------	-------	-------	-------	-------	-------	-------	-------	-------	-------	------

Temperature during heating periods in the rest of dwelling from Table 9, Th2(°C)

19.95	19.95	19.95	19.95	19.95	19.95	19.95	19.95	19.95	19.95	19.95	19.95	(88)
-------	-------	-------	-------	-------	-------	-------	-------	-------	-------	-------	-------	------

Utilisation factor for gains for rest of dwelling n2,m

0.99	0.98	0.96	0.90	0.78	0.59	0.40	0.45	0.72	0.92	0.98	0.99	(89)
------	------	------	------	------	------	------	------	------	------	------	------	------

Mean internal temperature in the rest of dwelling T2 (follow steps 3 to 7 in Table 9c)

18.06	18.31	18.73	19.24	19.67	19.88	19.94	19.93	19.80	19.27	18.56	17.98	(90)
-------	-------	-------	-------	-------	-------	-------	-------	-------	-------	-------	-------	------

Living area fraction

Living area ÷ (4) = 0.43 (91)

Mean internal temperature for the whole dwelling fLA x T1 +(1 - fLA) x T2

18.71	18.93	19.29	19.74	20.12	20.33	20.38	20.38	20.24	19.77	19.14	18.64	(92)
-------	-------	-------	-------	-------	-------	-------	-------	-------	-------	-------	-------	------

Apply adjustment to the mean internal temperature from Table 4e where appropriate

18.56	18.78	19.14	19.59	19.97	20.18	20.23	20.23	20.09	19.62	18.99	18.49	(93)
-------	-------	-------	-------	-------	-------	-------	-------	-------	-------	-------	-------	------

8. Space heating requirement

Utilisation factor for gains, ηm

0.98	0.97	0.95	0.89	0.78	0.61	0.44	0.49	0.73	0.91	0.97	0.99	(94)
------	------	------	------	------	------	------	------	------	------	------	------	------

Useful gains, ηmGm, W (94)m x (84)m

298.72	334.55	361.31	373.21	346.36	264.12	180.93	188.62	263.20	295.94	287.97	284.50	(95)
--------	--------	--------	--------	--------	--------	--------	--------	--------	--------	--------	--------	------

Monthly average external temperature from Table U1

4.30	4.90	6.50	8.90	11.70	14.60	16.60	16.40	14.10	10.60	7.10	4.20	(96)
------	------	------	------	-------	-------	-------	-------	-------	-------	------	------	------

Heat loss rate for mean internal temperature, Lm, W [(39)m x (93)m - (96)m]

724.83	705.63	642.72	543.52	420.52	283.57	184.78	194.55	304.71	458.32	604.67	726.62	(97)
--------	--------	--------	--------	--------	--------	--------	--------	--------	--------	--------	--------	------

Space heating requirement, kWh/month $0.024 \times [(97)m - (95)m] \times (41)m$

317.02	249.37	209.37	122.62	55.18	0.00	0.00	0.00	120.81	228.02	328.94		(98)
$\Sigma(98)1...5, 10...12 =$											1631.33	

Space heating requirement kWh/m²/year

(98) ÷ (4) = 37.40 (99)

9a. Energy requirements - individual heating systems including micro-CHP

Space heating

Fraction of space heat from secondary/supplementary system (table 11) 0.00 (201)

Fraction of space heat from main system(s) 1 - (201) = 1.00 (202)

Fraction of space heat from main system 2 0.00 (202)

Fraction of total space heat from main system 1 (202) x [1 - (203)] = 1.00 (204)

Fraction of total space heat from main system 2 (202) x (203) = 0.00 (205)

Efficiency of main system 1 (%) 93.00 (206)

Space heating fuel (main system 1), kWh/month

340.89	268.14	225.12	131.85	59.33	0.00	0.00	0.00	0.00	129.90	245.19	353.70	(211)
$\Sigma(211)1...5, 10...12 =$											1754.11	

Water heating

Efficiency of water heater

89.17	89.10	88.94	88.61	87.97	86.70	86.70	86.70	86.70	86.70	88.56	89.01	89.21	(217)
-------	-------	-------	-------	-------	-------	-------	-------	-------	-------	-------	-------	-------	-------

Water heating fuel, kWh/month

115.42	101.51	106.89	97.38	96.64	88.12	85.85	93.79	93.49	102.10	106.21	112.57	(219)
$\Sigma(219)1...12 =$											1199.98	

Annual totals

Space heating fuel - main system 1 1754.11

Water heating fuel 1199.98

Electricity for pumps, fans and electric keep-hot (Table 4f)

mechanical ventilation fans - balanced, extract or positive input from outside 31.14 (230a)

central heating pump or water pump within warm air heating unit 30.00 (230c)

boiler flue fan		45.00		(230e)
Total electricity for the above, kWh/year			106.14	(231)
Electricity for lighting (Appendix L)			213.73	(232)
Total delivered energy for all uses	(211)...(221) + (231) + (232)...(237b) =		3273.96	(238)

10a. Fuel costs - individual heating systems including micro-CHP

	Fuel kWh/year		Fuel price		Fuel cost £/year	
Space heating - main system 1	1754.11	x	3.48	x 0.01 =	61.04	(240)
Water heating	1199.98	x	3.48	x 0.01 =	41.76	(247)
Pumps and fans	106.14	x	13.19	x 0.01 =	14.00	(249)
Electricity for lighting	213.73	x	13.19	x 0.01 =	28.19	(250)
Additional standing charges					120.00	(251)
Total energy cost			(240)...(242) + (245)...(254) =		264.99	(255)

11a. SAP rating - individual heating systems including micro-CHP

Energy cost deflator (Table 12)	0.42	(256)
Energy cost factor (ECF)	1.26	(257)
SAP value	82.48	
SAP rating (section 13)	82	(258)
SAP band	B	

12a. CO₂ emissions - individual heating systems including micro-CHP

	Energy kWh/year		Emission factor kg CO ₂ /kWh		Emissions kg CO ₂ /year	
Space heating - main system 1	1754.11	x	0.216	=	378.89	(261)
Water heating	1199.98	x	0.216	=	259.20	(264)
Space and water heating			(261) + (262) + (263) + (264) =		638.08	(265)
Pumps and fans	106.14	x	0.519	=	55.08	(267)
Electricity for lighting	213.73	x	0.519	=	110.93	(268)
Total CO ₂ , kg/year			(265)...(271) =		804.10	(272)
Dwelling CO ₂ emission rate			(272) ÷ (4) =		18.43	(273)
EI value					87.84	
EI rating (section 14)					88	(274)
EI band					B	

13a. Primary energy - individual heating systems including micro-CHP

	Energy kWh/year		Primary factor		Primary Energy kWh/year	
Space heating - main system 1	1754.11	x	1.22	=	2140.02	(261)
Water heating	1199.98	x	1.22	=	1463.98	(264)
Space and water heating			(261) + (262) + (263) + (264) =		3604.00	(265)
Pumps and fans	106.14	x	3.07	=	325.84	(267)
Electricity for lighting	213.73	x	3.07	=	656.16	(268)
Primary energy kWh/year					4585.99	(272)
Dwelling primary energy rate kWh/m ² /year					105.13	(273)

DER Worksheet Design - Draft



This design submission has been carried out using Approved SAP software. It has been prepared from plans and specifications and may not reflect the property as constructed.

Assessor name	Mr Simon Gowing	Assessor number	9641
Client		Last modified	29/10/2018
Address	HA3B - END Oxford Road, Bodicaote, OX15		

1. Overall dwelling dimensions

	Area (m ²)		Average storey height (m)		Volume (m ³)
Lowest occupied +1	46.26 (1a) x		2.39 (2a) =		110.56 (3a)
Total floor area	46.26 (1b) x		2.61 (2b) =		120.74 (3b)
Dwelling volume	(1a) + (1b) + (1c) + (1d)...(1n) =			(3a) + (3b) + (3c) + (3d)...(3n) =	231.30 (5)

2. Ventilation rate

			m ³ per hour
Number of chimneys	0	x 40 =	0 (6a)
Number of open flues	0	x 20 =	0 (6b)
Number of intermittent fans	3	x 10 =	30 (7a)
Number of passive vents	0	x 10 =	0 (7b)
Number of flueless gas fires	0	x 40 =	0 (7c)
			Air changes per hour
Infiltration due to chimneys, flues, fans, PSVs	(6a) + (6b) + (7a) + (7b) + (7c) =	30	÷ (5) = 0.13 (8)
<i>If a pressurisation test has been carried out or is intended, proceed to (17), otherwise continue from (9) to (16)</i>			
Air permeability value, q ₅₀ , expressed in cubic metres per hour per square metre of envelope area			5.00 (17)
If based on air permeability value, then (18) = [(17) ÷ 20] + (8), otherwise (18) = (16)			0.38 (18)
Number of sides on which the dwelling is sheltered			1 (19)
Shelter factor		1 - [0.075 x (19)] =	0.93 (20)
Infiltration rate incorporating shelter factor		(18) x (20) =	0.35 (21)

	Jan	Feb	Mar	Apr	May	Jun	Jul	Aug	Sep	Oct	Nov	Dec
Monthly average wind speed from Table U2	5.10	5.00	4.90	4.40	4.30	3.80	3.80	3.70	4.00	4.30	4.50	4.70
Wind factor (22)m ÷ 4	1.28	1.25	1.23	1.10	1.08	0.95	0.95	0.93	1.00	1.08	1.13	1.18
Adjusted infiltration rate (allowing for shelter and wind factor) (21) x (22a)m	0.45	0.44	0.43	0.39	0.38	0.33	0.33	0.32	0.35	0.38	0.40	0.41

Calculate effective air change rate for the applicable case:

If mechanical ventilation: air change rate through system N/A (23a)

If balanced with heat recovery: efficiency in % allowing for in-use factor from Table 4h N/A (23c)

d) natural ventilation or whole house positive input ventilation from loft

0.60	0.60	0.59	0.57	0.57	0.56	0.56	0.55	0.56	0.57	0.58	0.59
------	------	------	------	------	------	------	------	------	------	------	------

(24d)

Effective air change rate - enter (24a) or (24b) or (24c) or (24d) in (25)



0.60	0.60	0.59	0.57	0.57	0.56	0.56	0.55	0.56	0.57	0.58	0.59
------	------	------	------	------	------	------	------	------	------	------	------

(25)

3. Heat losses and heat loss parameter

Element	Gross area, m ²	Openings m ²	Net area A, m ²	U-value W/m ² K	A x U W/K	k-value, kJ/m ² .K	A x k, kJ/K
---------	----------------------------	-------------------------	----------------------------	----------------------------	-----------	-------------------------------	-------------

Window 14.29 x 1.24 = 17.66 (27)

Door 2.12 x 1.30 = 2.76 (26)

Ground floor 46.29 x 0.16 = 7.41 (28a)

External wall 96.27 x 0.21 = 20.22 (29a)

Party wall 30.63 x 0.00 = 0.00 (32)

Roof 46.37 x 0.11 = 5.10 (30)

Total area of external elements ΣA, m² 205.34 (31)

Fabric heat loss, W/K = Σ(A x U) (26)...(30) + (32) = 53.14 (33)

Heat capacity Cm = Σ(A x k) (28)...(30) + (32) + (32a)...(32e) = N/A (34)

Thermal mass parameter (TMP) in kJ/m²K 250.00 (35)

Thermal bridges: Σ(L x Ψ) calculated using Appendix K 10.20 (36)

Total fabric heat loss (33) + (36) = 63.34 (37)

Jan	Feb	Mar	Apr	May	Jun	Jul	Aug	Sep	Oct	Nov	Dec
45.82	45.52	45.23	43.86	43.61	42.41	42.41	42.19	42.87	43.61	44.12	44.66

(38)

Jan	Feb	Mar	Apr	May	Jun	Jul	Aug	Sep	Oct	Nov	Dec
109.16	108.86	108.57	107.20	106.94	105.75	105.75	105.53	106.21	106.94	107.46	108.00
Average = Σ(39)1...12/12 = 107.20 (39)											

Jan	Feb	Mar	Apr	May	Jun	Jul	Aug	Sep	Oct	Nov	Dec
1.18	1.18	1.17	1.16	1.16	1.14	1.14	1.14	1.15	1.16	1.16	1.17
Average = Σ(40)1...12/12 = 1.16 (40)											

Jan	Feb	Mar	Apr	May	Jun	Jul	Aug	Sep	Oct	Nov	Dec
31.00	28.00	31.00	30.00	31.00	30.00	31.00	31.00	30.00	31.00	30.00	31.00

(40)

4. Water heating energy requirement

Assumed occupancy, N	2.66
Annual average hot water usage in litres per day Vd,average = (25 x N) + 36	97.34

(42)

(43)

Jan	Feb	Mar	Apr	May	Jun	Jul	Aug	Sep	Oct	Nov	Dec
107.08	103.18	99.29	95.40	91.50	87.61	87.61	91.50	95.40	99.29	103.18	107.08
Σ(44)1...12 = 1168.12 (44)											

Jan	Feb	Mar	Apr	May	Jun	Jul	Aug	Sep	Oct	Nov	Dec
158.79	138.88	143.31	124.94	119.89	103.45	95.86	110.01	111.32	129.73	141.61	153.78
Σ(45)1...12 = 1531.59 (45)											

Jan	Feb	Mar	Apr	May	Jun	Jul	Aug	Sep	Oct	Nov	Dec
23.82	20.83	21.50	18.74	17.98	15.52	14.38	16.50	16.70	19.46	21.24	23.07

(46)

Jan	Feb	Mar	Apr	May	Jun	Jul	Aug	Sep	Oct	Nov	Dec
0.00	0.00	0.00	0.00	0.00	0.00	0.00	0.00	0.00	0.00	0.00	0.00

(56)

Jan	Feb	Mar	Apr	May	Jun	Jul	Aug	Sep	Oct	Nov	Dec
0.00	0.00	0.00	0.00	0.00	0.00	0.00	0.00	0.00	0.00	0.00	0.00

(57)

Jan	Feb	Mar	Apr	May	Jun	Jul	Aug	Sep	Oct	Nov	Dec
0.00	0.00	0.00	0.00	0.00	0.00	0.00	0.00	0.00	0.00	0.00	0.00

(59)

Jan	Feb	Mar	Apr	May	Jun	Jul	Aug	Sep	Oct	Nov	Dec
21.95	19.80	21.88	21.09	21.73	20.96	21.62	21.69	21.03	21.82	21.19	21.93

(61)

180.74	158.69	165.19	146.03	141.62	124.42	117.48	131.70	132.35	151.55	162.80	175.71
--------	--------	--------	--------	--------	--------	--------	--------	--------	--------	--------	--------

(62)

-55.13	-48.51	-49.51	-40.73	-37.82	-31.20	-26.41	-31.97	-32.91	-40.68	-47.12	-53.28
--------	--------	--------	--------	--------	--------	--------	--------	--------	--------	--------	--------

(63)

125.61	110.18	115.68	105.30	103.80	93.21	91.08	99.73	99.45	110.87	115.68	122.43
Σ(64)1...12 = 1293.01 (64)											

58.29	51.13	53.12	46.82	45.30	39.64	37.28	42.00	42.27	48.59	52.38	56.61
-------	-------	-------	-------	-------	-------	-------	-------	-------	-------	-------	-------

(65)

5. Internal gains

Jan	Feb	Mar	Apr	May	Jun	Jul	Aug	Sep	Oct	Nov	Dec
132.93	132.93	132.93	132.93	132.93	132.93	132.93	132.93	132.93	132.93	132.93	132.93

(66)

Jan	Feb	Mar	Apr	May	Jun	Jul	Aug	Sep	Oct	Nov	Dec
22.82	20.27	16.48	12.48	9.33	7.88	8.51	11.06	14.85	18.85	22.00	23.46

(67)

Jan	Feb	Mar	Apr	May	Jun	Jul	Aug	Sep	Oct	Nov	Dec
243.64	246.17	239.80	226.23	209.11	193.02	182.27	179.74	186.11	199.68	216.80	232.89

(68)

Jan	Feb	Mar	Apr	May	Jun	Jul	Aug	Sep	Oct	Nov	Dec
36.29	36.29	36.29	36.29	36.29	36.29	36.29	36.29	36.29	36.29	36.29	36.29

(69)

Jan	Feb	Mar	Apr	May	Jun	Jul	Aug	Sep	Oct	Nov	Dec
3.00	3.00	3.00	3.00	3.00	3.00	3.00	3.00	3.00	3.00	3.00	3.00

(70)

Jan	Feb	Mar	Apr	May	Jun	Jul	Aug	Sep	Oct	Nov	Dec
-106.35	-106.35	-106.35	-106.35	-106.35	-106.35	-106.35	-106.35	-106.35	-106.35	-106.35	-106.35

(71)

Jan	Feb	Mar	Apr	May	Jun	Jul	Aug	Sep	Oct	Nov	Dec
78.34	76.09	71.40	65.02	60.88	55.05	50.11	56.45	58.71	65.31	72.75	76.09

(72)

410.68	408.40	393.56	369.61	345.20	321.83	306.77	313.14	325.55	349.72	377.43	398.32
--------	--------	--------	--------	--------	--------	--------	--------	--------	--------	--------	--------

(73)

6. Solar gains

	Access factor Table 6d	Area m ²	Solar flux W/m ²	g specific data or Table 6b	FF specific data or Table 6c	Gains W
NorthEast	0.77	3.15	11.28	0.63	0.70	10.86 (75)
SouthWest	0.77	7.54	36.79	0.63	0.70	84.78 (79)
South	0.77	1.50	46.75	0.63	0.70	21.43 (78)
NorthWest	0.77	2.10	11.28	0.63	0.70	7.24 (81)

124.32	216.37	308.70	404.40	473.46	479.18	458.17	405.16	341.57	242.51	149.74	105.86
--------	--------	--------	--------	--------	--------	--------	--------	--------	--------	--------	--------

(83)

535.00	624.77	702.26	774.02	818.66	801.01	764.94	718.30	667.12	592.22	527.17	504.18
--------	--------	--------	--------	--------	--------	--------	--------	--------	--------	--------	--------

(84)

7. Mean internal temperature (heating season)

21.00

(85)

Jan	Feb	Mar	Apr	May	Jun	Jul	Aug	Sep	Oct	Nov	Dec
1.00	1.00	0.99	0.97	0.90	0.76	0.59	0.64	0.87	0.98	1.00	1.00

(86)

19.70	19.86	20.11	20.44	20.74	20.93	20.98	20.98	20.85	20.46	20.02	19.67
-------	-------	-------	-------	-------	-------	-------	-------	-------	-------	-------	-------

(87)

Temperature during heating periods in the rest of dwelling from Table 9, Th2(°C)

19.94	19.94	19.94	19.95	19.96	19.97	19.97	19.97	19.96	19.96	19.95	19.95	(88)
-------	-------	-------	-------	-------	-------	-------	-------	-------	-------	-------	-------	------

Utilisation factor for gains for rest of dwelling n2,m

1.00	0.99	0.99	0.96	0.86	0.67	0.46	0.51	0.80	0.97	0.99	1.00	(89)
------	------	------	------	------	------	------	------	------	------	------	------	------

Mean internal temperature in the rest of dwelling T2 (follow steps 3 to 7 in Table 9c)

18.20	18.44	18.81	19.29	19.69	19.92	19.96	19.96	19.83	19.32	18.68	18.17	(90)
-------	-------	-------	-------	-------	-------	-------	-------	-------	-------	-------	-------	------

Living area fraction

Living area ÷ (4) = (91)

Mean internal temperature for the whole dwelling fLA x T1 +(1 - fLA) x T2

18.54	18.76	19.10	19.55	19.93	20.15	20.19	20.19	20.06	19.58	18.98	18.51	(92)
-------	-------	-------	-------	-------	-------	-------	-------	-------	-------	-------	-------	------

Apply adjustment to the mean internal temperature from Table 4e where appropriate

18.39	18.61	18.95	19.40	19.78	20.00	20.04	20.04	19.91	19.43	18.83	18.36	(93)
-------	-------	-------	-------	-------	-------	-------	-------	-------	-------	-------	-------	------

8. Space heating requirement

Jan	Feb	Mar	Apr	May	Jun	Jul	Aug	Sep	Oct	Nov	Dec
-----	-----	-----	-----	-----	-----	-----	-----	-----	-----	-----	-----

Utilisation factor for gains, ηm

1.00	0.99	0.98	0.95	0.86	0.67	0.47	0.52	0.80	0.96	0.99	1.00	(94)
------	------	------	------	------	------	------	------	------	------	------	------	------

Useful gains, ηmGm, W (94)m x (84)m

533.07	619.80	688.76	732.43	700.16	536.73	359.55	376.34	533.98	569.48	523.18	502.81	(95)
--------	--------	--------	--------	--------	--------	--------	--------	--------	--------	--------	--------	------

Monthly average external temperature from Table U1

4.30	4.90	6.50	8.90	11.70	14.60	16.60	16.40	14.10	10.60	7.10	4.20	(96)
------	------	------	------	-------	-------	-------	-------	-------	-------	------	------	------

Heat loss rate for mean internal temperature, Lm, W [(39)m x ((93)m - (96)m)]

1538.25	1492.40	1351.97	1126.03	864.33	570.72	364.09	384.04	617.51	944.41	1261.03	1529.68	(97)
---------	---------	---------	---------	--------	--------	--------	--------	--------	--------	---------	---------	------

Space heating requirement, kWh/month 0.024 x ((97)m - (95)m) x (41)m

747.85	586.39	493.43	283.39	122.14	0.00	0.00	0.00	0.00	278.94	531.25	763.99	(98)
--------	--------	--------	--------	--------	------	------	------	------	--------	--------	--------	------

Σ(98)1...5, 10...12 = (98)

Space heating requirement kWh/m²/year

(98) ÷ (4) = (99)

9a. Energy requirements - individual heating systems including micro-CHP

Space heating

Fraction of space heat from secondary/supplementary system (table 11)

(201)

Fraction of space heat from main system(s)

1 - (201) = (202)

Fraction of space heat from main system 2

(202)

Fraction of total space heat from main system 1

(202) x [1 - (203)] = (204)

Fraction of total space heat from main system 2

(202) x (203) = (205)

Efficiency of main system 1 (%)

(206)

Jan	Feb	Mar	Apr	May	Jun	Jul	Aug	Sep	Oct	Nov	Dec
-----	-----	-----	-----	-----	-----	-----	-----	-----	-----	-----	-----

Space heating fuel (main system 1), kWh/month

804.14	630.52	530.57	304.72	131.33	0.00	0.00	0.00	0.00	299.94	571.24	821.49	(211)
--------	--------	--------	--------	--------	------	------	------	------	--------	--------	--------	-------

Σ(211)1...5, 10...12 = (211)

Water heating

Efficiency of water heater

89.51	89.46	89.35	89.08	88.45	86.70	86.70	86.70	86.70	89.04	89.39	89.53	(217)
-------	-------	-------	-------	-------	-------	-------	-------	-------	-------	-------	-------	-------

Water heating fuel, kWh/month

140.33	123.16	129.47	118.21	117.35	107.51	105.05	115.02	114.70	124.52	129.41	136.74	(219)
--------	--------	--------	--------	--------	--------	--------	--------	--------	--------	--------	--------	-------

Σ(219a)1...12 = (219)

Annual totals

Space heating fuel - main system 1

Water heating fuel

Electricity for pumps, fans and electric keep-hot (Table 4f)

central heating pump or water pump within warm air heating unit

(230c)

boiler flue fan

(230e)

Total electricity for the above, kWh/year

(231)

Electricity for lighting (Appendix L)

(232)

Total delivered energy for all uses

(211)...(221) + (231) + (232)...(237b) = (238)

10a. Fuel costs - individual heating systems including micro-CHP

	Fuel kWh/year		Fuel price		Fuel cost £/year	
Space heating - main system 1	<input type="text" value="4093.96"/>	x	<input type="text" value="3.48"/>	x 0.01 =	<input type="text" value="142.47"/>	(240)
Water heating	<input type="text" value="1461.47"/>	x	<input type="text" value="3.48"/>	x 0.01 =	<input type="text" value="50.86"/>	(247)
Pumps and fans	<input type="text" value="75.00"/>	x	<input type="text" value="13.19"/>	x 0.01 =	<input type="text" value="9.89"/>	(249)
Electricity for lighting	<input type="text" value="403.04"/>	x	<input type="text" value="13.19"/>	x 0.01 =	<input type="text" value="53.16"/>	(250)
Additional standing charges					<input type="text" value="120.00"/>	(251)
Total energy cost				(240)...(242) + (245)...(254) =	<input type="text" value="376.38"/>	(255)

11a. SAP rating - individual heating systems including micro-CHP

Energy cost deflator (Table 12)	<input type="text" value="0.42"/>	(256)
Energy cost factor (ECF)	<input type="text" value="1.15"/>	(257)
SAP value	<input type="text" value="83.96"/>	(258)
SAP rating (section 13)	<input type="text" value="84"/>	(258)
SAP band	<input type="text" value="B"/>	

12a. CO₂ emissions - individual heating systems including micro-CHP

	Energy kWh/year		Emission factor kg CO ₂ /kWh		Emissions kg CO ₂ /year	
Space heating - main system 1	<input type="text" value="4093.96"/>	x	<input type="text" value="0.216"/>	=	<input type="text" value="884.29"/>	(261)
Water heating	<input type="text" value="1461.47"/>	x	<input type="text" value="0.216"/>	=	<input type="text" value="315.68"/>	(264)
Space and water heating				(261) + (262) + (263) + (264) =	<input type="text" value="1199.97"/>	(265)
Pumps and fans	<input type="text" value="75.00"/>	x	<input type="text" value="0.519"/>	=	<input type="text" value="38.93"/>	(267)
Electricity for lighting	<input type="text" value="403.04"/>	x	<input type="text" value="0.519"/>	=	<input type="text" value="209.18"/>	(268)
Total CO ₂ , kg/year				(265)...(271) =	<input type="text" value="1448.08"/>	(272)
Dwelling CO ₂ emission rate				(272) ÷ (4) =	<input type="text" value="15.65"/>	(273)
EI value					<input type="text" value="85.89"/>	
EI rating (section 14)					<input type="text" value="86"/>	(274)
EI band					<input type="text" value="B"/>	

13a. Primary energy - individual heating systems including micro-CHP

	Energy kWh/year		Primary factor		Primary Energy kWh/year	
Space heating - main system 1	<input type="text" value="4093.96"/>	x	<input type="text" value="1.22"/>	=	<input type="text" value="4994.63"/>	(261)
Water heating	<input type="text" value="1461.47"/>	x	<input type="text" value="1.22"/>	=	<input type="text" value="1783.00"/>	(264)
Space and water heating				(261) + (262) + (263) + (264) =	<input type="text" value="6777.62"/>	(265)
Pumps and fans	<input type="text" value="75.00"/>	x	<input type="text" value="3.07"/>	=	<input type="text" value="230.25"/>	(267)
Electricity for lighting	<input type="text" value="403.04"/>	x	<input type="text" value="3.07"/>	=	<input type="text" value="1237.34"/>	(268)
Primary energy kWh/year					<input type="text" value="8245.21"/>	(272)
Dwelling primary energy rate kWh/m ² /year					<input type="text" value="89.12"/>	(273)

This design submission has been carried out using Approved SAP software. It has been prepared from plans and specifications and may not reflect the property as constructed.

Assessor name	Mr Simon Gowing	Assessor number	9641
Client		Last modified	29/10/2018
Address	HALSTEAD Oxford Road, Bodicaote, OX15		

1. Overall dwelling dimensions

	Area (m ²)	Average storey height (m)	Volume (m ³)
Lowest occupied	37.84 (1a) x	2.39 (2a) =	90.44 (3a)
+1	37.84 (1b) x	2.61 (2b) =	98.76 (3b)
+2	35.45 (1c) x	2.36 (2c) =	83.66 (3c)
Total floor area	(1a) + (1b) + (1c) + (1d)...(1n) =		111.13 (4)
Dwelling volume	(3a) + (3b) + (3c) + (3d)...(3n) =		272.86 (5)

2. Ventilation rate

		m ³ per hour
Number of chimneys	0 x 40 =	0 (6a)
Number of open flues	0 x 20 =	0 (6b)
Number of intermittent fans	4 x 10 =	40 (7a)
Number of passive vents	0 x 10 =	0 (7b)
Number of flueless gas fires	0 x 40 =	0 (7c)
Air changes per hour		
Infiltration due to chimneys, flues, fans, PSVs	(6a) + (6b) + (7a) + (7b) + (7c) =	40 ÷ (5) = 0.15 (8)
<i>If a pressurisation test has been carried out or is intended, proceed to (17), otherwise continue from (9) to (16)</i>		
Air permeability value, q50, expressed in cubic metres per hour per square metre of envelope area		5.00 (17)
If based on air permeability value, then (18) = [(17) ÷ 20] + (8), otherwise (18) = (16)		0.40 (18)
Number of sides on which the dwelling is sheltered		2 (19)
Shelter factor	1 - [0.075 x (19)] =	0.85 (20)
Infiltration rate incorporating shelter factor	(18) x (20) =	0.34 (21)

Infiltration rate modified for monthly wind speed:

	Jan	Feb	Mar	Apr	May	Jun	Jul	Aug	Sep	Oct	Nov	Dec
Monthly average wind speed from Table U2	5.10	5.00	4.90	4.40	4.30	3.80	3.80	3.70	4.00	4.30	4.50	4.70 (22)
Wind factor (22)m ÷ 4	1.28	1.25	1.23	1.10	1.08	0.95	0.95	0.93	1.00	1.08	1.13	1.18 (22a)
Adjusted infiltration rate (allowing for shelter and wind factor) (21) x (22a)m	0.43	0.42	0.41	0.37	0.36	0.32	0.32	0.31	0.34	0.36	0.38	0.40 (22b)

Calculate effective air change rate for the applicable case:

If mechanical ventilation: air change rate through system N/A (23a)

If balanced with heat recovery: efficiency in % allowing for in-use factor from Table 4h N/A (23c)

d) natural ventilation or whole house positive input ventilation from loft

0.59	0.59	0.59	0.57	0.57	0.55	0.55	0.55	0.56	0.57	0.57	0.58	(24d)
------	------	------	------	------	------	------	------	------	------	------	------	-------

Effective air change rate - enter (24a) or (24b) or (24c) or (24d) in (25)

0.59	0.59	0.59	0.57	0.57	0.55	0.55	0.55	0.56	0.57	0.57	0.58	(25)
------	------	------	------	------	------	------	------	------	------	------	------	------

3. Heat losses and heat loss parameter

Element	Gross area, m ²	Openings m ²	Net area A, m ²	U-value W/m ² K	A x U W/K	k-value, kJ/m ² .K	A x k, kJ/K
Window			15.96	1.24	19.72		(27)
Roof window			0.88	1.33	1.17		(27a)
Door			2.02	1.30	2.63		(26)
Ground floor			37.84	0.15	5.68		(28a)
External wall			93.46	0.21	19.63		(29a)
Party wall			58.25	0.00	0.00		(32)
External wall			2.84	0.20	0.57		(29a)
Roof			24.76	0.12	2.85		(30)
Roof			12.84	0.16	2.05		(30)
Roof			2.59	0.21	0.54		(30)
Total area of external elements ΣA, m ²			193.19				(31)

Fabric heat loss, W/K = Σ(A x U) (26)...(30) + (32) = 54.83 (33)

Heat capacity Cm = Σ(A x k) (28)...(30) + (32) + (32a)...(32e) = N/A (34)

Thermal mass parameter (TMP) in kJ/m²K 250.00 (35)

Thermal bridges: Σ(L x Ψ) calculated using Appendix K 11.02 (36)

Total fabric heat loss (33) + (36) = 65.86 (37)

	Jan	Feb	Mar	Apr	May	Jun	Jul	Aug	Sep	Oct	Nov	Dec
Ventilation heat loss calculated monthly 0.33 x (25)m x (5)	53.34	53.02	52.70	51.21	50.93	49.64	49.64	49.40	50.14	50.93	51.50	52.09 (38)

Heat transfer coefficient, W/K (37)m + (38)m

119.19	118.87	118.56	117.07	116.79	115.50	115.50	115.26	115.99	116.79	117.35	117.94
--------	--------	--------	--------	--------	--------	--------	--------	--------	--------	--------	--------

Average = Σ(39)1...12/12 = 117.07 (39)

Heat loss parameter (HLP), W/m²K (39)m ÷ (4)

1.07	1.07	1.07	1.05	1.05	1.04	1.04	1.04	1.04	1.05	1.06	1.06
------	------	------	------	------	------	------	------	------	------	------	------

Average = Σ(40)1...12/12 = 1.05 (40)

Number of days in month (Table 1a)

31.00	28.00	31.00	30.00	31.00	30.00	31.00	31.00	30.00	31.00	30.00	31.00	(40)
-------	-------	-------	-------	-------	-------	-------	-------	-------	-------	-------	-------	------

4. Water heating energy requirement

Assumed occupancy, N 2.82 (42)

Annual average hot water usage in litres per day Vd,average = (25 x N) + 36 101.21 (43)

	Jan	Feb	Mar	Apr	May	Jun	Jul	Aug	Sep	Oct	Nov	Dec
Hot water usage in litres per day for each month Vd,m = factor from Table 1c x (43)	111.33	107.28	103.23	99.19	95.14	91.09	91.09	95.14	99.19	103.23	107.28	111.33
	Σ(44)1...12 = 1214.51 (44)											

Energy content of hot water used = 4.18 x Vd,m x nm x Tm/3600 kWh/month (see Tables 1b, 1c 1d)

165.10	144.40	149.00	129.91	124.65	107.56	99.67	114.37	115.74	134.88	147.24	159.89
--------	--------	--------	--------	--------	--------	-------	--------	--------	--------	--------	--------

Σ(45)1...12 = 1592.42 (45)

Distribution loss 0.15 x (45)m

24.76	21.66	22.35	19.49	18.70	16.13	14.95	17.16	17.36	20.23	22.09	23.98
-------	-------	-------	-------	-------	-------	-------	-------	-------	-------	-------	-------

Storage volume (litres) including any solar or WWHRS storage within same vessel 250.00 (47)

Water storage loss:

a) If manufacturer's declared loss factor is known (kWh/day) 1.67 (48)

Temperature factor from Table 2b	0.54	(49)											
Energy lost from water storage (kWh/day) (48) x (49)	0.90	(50)											
Enter (50) or (54) in (55)	0.90	(55)											
Water storage loss calculated for each month (55) x (41)m	27.96	25.25	27.96	27.05	27.96	27.96	27.05	27.96	27.05	27.96	(56)		
If the vessel contains dedicated solar storage or dedicated WWHRS (56)m x [(47) - Vs] ÷ (47), else (56)	27.96	25.25	27.96	27.05	27.96	27.05	27.96	27.05	27.96	27.05	27.96	(57)	
Primary circuit loss for each month from Table 3	23.26	21.01	23.26	22.51	23.26	22.51	23.26	23.26	22.51	23.26	22.51	23.26	(59)
Combi loss for each month from Table 3a, 3b or 3c	0.00	0.00	0.00	0.00	0.00	0.00	0.00	0.00	0.00	0.00	0.00	0.00	(61)
Total heat required for water heating calculated for each month 0.85 x (45)m + (46)m + (57)m + (59)m + (61)m	216.32	190.66	200.22	179.47	175.87	157.13	150.89	165.59	165.31	186.10	196.80	211.11	(62)
Solar DHW input calculated using Appendix G or Appendix H	-58.03	-51.06	-52.12	-42.87	-39.80	-32.83	-27.78	-33.64	-34.62	-42.81	-49.59	-56.09	(63)
Output from water heater for each month (kWh/month) (62)m + (63)m	158.28	139.60	148.11	136.60	136.06	124.30	123.11	131.95	130.68	143.30	147.21	155.01	(64)
	$\sum(64)1...12 =$											1674.22	(64)
Heat gains from water heating (kWh/month) 0.25 x [0.85 x (45)m + (61)m] + 0.8 x [(46)m + (57)m + (59)m]	95.87	85.02	90.52	82.85	82.42	75.42	74.12	79.00	78.14	85.82	88.61	94.14	(65)

5. Internal gains

	Jan	Feb	Mar	Apr	May	Jun	Jul	Aug	Sep	Oct	Nov	Dec	
Metabolic gains (Table 5)	141.07	141.07	141.07	141.07	141.07	141.07	141.07	141.07	141.07	141.07	141.07	141.07	(66)
Lighting gains (calculated in Appendix L, equation L9 or L9a), also see Table 5	25.63	22.77	18.52	14.02	10.48	8.85	9.56	12.42	16.68	21.17	24.71	26.34	(67)
Appliance gains (calculated in Appendix L, equation L13 or L13a), also see Table 5	273.17	276.00	268.86	253.65	234.46	216.42	204.36	201.53	208.67	223.88	243.07	261.12	(68)
Cooking gains (calculated in Appendix L, equation L15 or L15a), also see Table 5	37.11	37.11	37.11	37.11	37.11	37.11	37.11	37.11	37.11	37.11	37.11	37.11	(69)
Pump and fan gains (Table 5a)	3.00	3.00	3.00	3.00	3.00	3.00	3.00	3.00	3.00	3.00	3.00	3.00	(70)
Losses e.g. evaporation (Table 5)	-112.86	-112.86	-112.86	-112.86	-112.86	-112.86	-112.86	-112.86	-112.86	-112.86	-112.86	-112.86	(71)
Water heating gains (Table 5)	128.86	126.52	121.66	115.06	110.78	104.75	99.62	106.19	108.52	115.35	123.07	126.53	(72)
Total internal gains (66)m + (67)m + (68)m + (69)m + (70)m + (71)m + (72)m	495.98	493.61	477.36	451.06	424.04	398.33	381.86	388.46	402.19	428.73	459.18	482.31	(73)

6. Solar gains

	Access factor Table 6d	Area m ²	Solar flux W/m ²	g specific data or Table 6b	FF specific data or Table 6c	Gains W		
South	0.77	6.46	46.75	0.9	0.63	92.30	(78)	
North	0.77	7.47	10.63	0.9	0.63	24.28	(74)	
North	1.00	0.88	15.69	0.9	0.63	5.48	(74)	
West	0.77	2.03	19.64	0.9	0.63	12.18	(80)	
Solar gains in watts $\sum(74)m...(82)m$								

134.24	231.67	329.07	434.68	516.31	526.82	501.89	437.96	364.71	258.91	161.24	114.65	(83)
Total gains - internal and solar (73)m + (83)m												
630.22	725.28	806.43	885.74	940.35	925.15	883.75	826.42	766.91	687.64	620.42	596.96	(84)

7. Mean internal temperature (heating season)

Temperature during heating periods in the living area from Table 9, Th1(°C)												21.00	(85)	
	Jan	Feb	Mar	Apr	May	Jun	Jul	Aug	Sep	Oct	Nov	Dec		
Utilisation factor for gains for living area n1,m (see Table 9a)	1.00	1.00	0.99	0.97	0.90	0.74	0.56	0.62	0.86	0.98	1.00	1.00	(86)	
Mean internal temp of living area T1 (steps 3 to 7 in Table 9c)	19.83	19.98	20.21	20.52	20.79	20.95	20.99	20.98	20.88	20.53	20.13	19.81	(87)	
Temperature during heating periods in the rest of dwelling from Table 9, Th2(°C)												20.02	(88)	
Utilisation factor for gains for rest of dwelling n2,m	1.00	1.00	0.99	0.96	0.86	0.65	0.45	0.50	0.80	0.97	1.00	1.00	(89)	
Mean internal temperature in the rest of dwelling T2 (follow steps 3 to 7 in Table 9c)	18.46	18.67	19.01	19.46	19.83	20.02	20.05	20.05	19.95	19.49	18.90	18.43	(90)	
Living area fraction												Living area ÷ (4) =	0.15	(91)
Mean internal temperature for the whole dwelling fLA x T1 + (1 - fLA) x T2	18.67	18.87	19.20	19.62	19.98	20.16	20.19	20.19	20.09	19.65	19.09	18.64	(92)	
Apply adjustment to the mean internal temperature from Table 4e where appropriate	18.52	18.72	19.05	19.47	19.83	20.01	20.04	20.04	19.94	19.50	18.94	18.49	(93)	

8. Space heating requirement

	Jan	Feb	Mar	Apr	May	Jun	Jul	Aug	Sep	Oct	Nov	Dec	
Utilisation factor for gains, ηm	1.00	0.99	0.98	0.95	0.85	0.65	0.45	0.50	0.79	0.96	0.99	1.00	(94)
Useful gains, ηmGm, W (94)m x (84)m	628.16	720.06	792.08	838.82	797.22	598.86	394.61	414.28	604.17	660.80	615.92	595.48	(95)
Monthly average external temperature from Table U1	4.30	4.90	6.50	8.90	11.70	14.60	16.60	16.40	14.10	10.60	7.10	4.20	(96)
Heat loss rate for mean internal temperature, Lm, W [(39)m x ((93)m - (96)m)]	1694.88	1643.14	1487.34	1237.95	949.18	624.74	397.42	419.42	677.37	1039.48	1389.42	1685.76	(97)
Space heating requirement, kWh/month 0.024 x ((97)m - (95)m) x (41)m	793.64	620.31	517.27	287.37	113.06	0.00	0.00	0.00	0.00	281.74	556.92	811.17	(98)
	$\sum(98)1...5, 10...12 =$											3981.47	(98)
Space heating requirement kWh/m ² /year	$(98) ÷ (4) =$											35.83	(99)

9a. Energy requirements - individual heating systems including micro-CHP

Space heating														
Fraction of space heat from secondary/supplementary system (table 11)												0.00	(201)	
Fraction of space heat from main system(s)												1 - (201) =	1.00	(202)
Fraction of space heat from main system 2												0.00	(202)	
Fraction of total space heat from main system 1												(202) x [1 - (203)] =	1.00	(204)
Fraction of total space heat from main system 2												(202) x (203) =	0.00	(205)
Efficiency of main system 1 (%)												93.00	(206)	
	Jan	Feb	Mar	Apr	May	Jun	Jul	Aug	Sep	Oct	Nov	Dec		
Space heating fuel (main system 1), kWh/month	853.38	667.00	556.20	309.00	121.57	0.00	0.00	0.00	0.00	302.94	598.84	872.22		

$$\Sigma(211)1...5, 10...12 = 4281.15 \quad (211)$$

Water heating

Efficiency of water heater

88.03	87.82	87.38	86.25	83.82	79.30	79.30	79.30	79.30	86.08	87.53	88.09	(217)
-------	-------	-------	-------	-------	-------	-------	-------	-------	-------	-------	-------	-------

Water heating fuel, kWh/month

179.82	158.95	169.51	158.38	162.32	156.74	155.24	166.40	164.80	166.46	168.18	175.97	(218)
--------	--------	--------	--------	--------	--------	--------	--------	--------	--------	--------	--------	-------

$$\Sigma(219a)1...12 = 1982.77 \quad (219)$$

Annual totals

Space heating fuel - main system 1

4281.15

Water heating fuel

1982.77

Electricity for pumps, fans and electric keep-hot (Table 4f)

central heating pump or water pump within warm air heating unit 30.00 (230c)

boiler flue fan 45.00 (230e)

Total electricity for the above, kWh/year

75.00 (231)

Electricity for lighting (Appendix L)

452.68 (232)

Total delivered energy for all uses

$$(211)...(221) + (231) + (232)...(237b) = 6791.60 \quad (238)$$

10a. Fuel costs - individual heating systems including micro-CHP

	Fuel kWh/year		Fuel price		Fuel cost £/year	
Space heating - main system 1	4281.15	x	3.48	x 0.01 =	148.98	(240)
Water heating	1982.77	x	3.48	x 0.01 =	69.00	(247)
Pumps and fans	75.00	x	13.19	x 0.01 =	9.89	(249)
Electricity for lighting	452.68	x	13.19	x 0.01 =	59.71	(250)
Additional standing charges					120.00	(251)
Total energy cost				(240)...(242) + (245)...(254) =	407.59	(255)

11a. SAP rating - individual heating systems including micro-CHP

Energy cost deflator (Table 12)	0.42	(256)
Energy cost factor (ECF)	1.10	(257)
SAP value	84.70	
SAP rating (section 13)	85	(258)
SAP band	B	

12a. CO₂ emissions - individual heating systems including micro-CHP

	Energy kWh/year		Emission factor kg CO ₂ /kWh		Emissions kg CO ₂ /year	
Space heating - main system 1	4281.15	x	0.216	=	924.73	(261)
Water heating	1982.77	x	0.216	=	428.28	(264)
Space and water heating				(261) + (262) + (263) + (264) =	1353.01	(265)
Pumps and fans	75.00	x	0.519	=	38.93	(267)
Electricity for lighting	452.68	x	0.519	=	234.94	(268)
Total CO ₂ , kg/year				(265)...(271) =	1626.87	(272)
Dwelling CO ₂ emission rate				(272) ÷ (4) =	14.64	(273)
EI value					86.04	
EI rating (section 14)					86	(274)
EI band					B	

13a. Primary energy - individual heating systems including micro-CHP

	Energy kWh/year		Primary factor		Primary Energy kWh/year	
Space heating - main system 1	4281.15	x	1.22	=	5223.01	(261)
Water heating	1982.77	x	1.22	=	2418.98	(264)
Space and water heating				(261) + (262) + (263) + (264) =	7641.98	(265)
Pumps and fans	75.00	x	3.07	=	230.25	(267)
Electricity for lighting	452.68	x	3.07	=	1389.72	(268)
Primary energy kWh/year					9261.96	(272)
Dwelling primary energy rate kWh/m ² /year					83.34	(273)

DER Worksheet

Design - Draft



This design submission has been carried out using Approved SAP software. It has been prepared from plans and specifications and may not reflect the property as constructed.

Assessor name	Mr Simon Gowing	Assessor number	9641
Client		Last modified	29/10/2018
Address	HARTLEY Oxford Road, Bodicaote, OX15		

1. Overall dwelling dimensions

	Area (m ²)	Average storey height (m)	Volume (m ³)
Lowest occupied +1	46.49 (1a) x 2.39 (2a) =		111.11 (3a)
Total floor area	46.50 (1b) x 2.61 (2b) =		121.37 (3b)
Dwelling volume	(1a) + (1b) + (1c) + (1d)...(1n) =	(3a) + (3b) + (3c) + (3d)...(3n) =	232.48 (5)

2. Ventilation rate

		m ³ per hour
Number of chimneys	0 x 40 =	0 (6a)
Number of open flues	0 x 20 =	0 (6b)
Number of intermittent fans	4 x 10 =	40 (7a)
Number of passive vents	0 x 10 =	0 (7b)
Number of flueless gas fires	0 x 40 =	0 (7c)

	Air changes per hour
Infiltration due to chimneys, flues, fans, PSVs	(6a) + (6b) + (7a) + (7b) + (7c) = 40 ÷ (5) = 0.17 (8)

If a pressurisation test has been carried out or is intended, proceed to (17), otherwise continue from (9) to (16)

Air permeability value, q ₅₀ , expressed in cubic metres per hour per square metre of envelope area	5.00 (17)
If based on air permeability value, then (18) = [(17) ÷ 20] + (8), otherwise (18) = (16)	0.42 (18)
Number of sides on which the dwelling is sheltered	2 (19)
Shelter factor	1 - [0.075 x (19)] = 0.85 (20)
Infiltration rate incorporating shelter factor	(18) x (20) = 0.36 (21)

	Jan	Feb	Mar	Apr	May	Jun	Jul	Aug	Sep	Oct	Nov	Dec
Monthly average wind speed from Table U2	5.10	5.00	4.90	4.40	4.30	3.80	3.80	3.70	4.00	4.30	4.50	4.70

	Jan	Feb	Mar	Apr	May	Jun	Jul	Aug	Sep	Oct	Nov	Dec
Wind factor (22)m ÷ 4	1.28	1.25	1.23	1.10	1.08	0.95	0.95	0.93	1.00	1.08	1.13	1.18

	Jan	Feb	Mar	Apr	May	Jun	Jul	Aug	Sep	Oct	Nov	Dec
Adjusted infiltration rate (allowing for shelter and wind factor) (21) x (22a)m	0.46	0.45	0.44	0.39	0.39	0.34	0.34	0.33	0.36	0.39	0.40	0.42

Calculate effective air change rate for the applicable case:	
If mechanical ventilation: air change rate through system	N/A (23a)
If balanced with heat recovery: efficiency in % allowing for in-use factor from Table 4h	N/A (23c)
d) natural ventilation or whole house positive input ventilation from loft	0.60 0.60 0.60 0.58 0.57 0.56 0.56 0.56 0.56 0.57 0.58 0.59 (24d)

Effective air change rate - enter (24a) or (24b) or (24c) or (24d) in (25)

0.60	0.60	0.60	0.58	0.57	0.56	0.56	0.56	0.56	0.57	0.58	0.59
------	------	------	------	------	------	------	------	------	------	------	------

3. Heat losses and heat loss parameter

Element	Gross area, m ²	Openings m ²	Net area A, m ²	U-value W/m ² K	A x U W/K	k-value, kJ/m ² .K	A x k, kJ/K
Window			14.52	1.24	17.94		
Door			2.02	1.30	2.63		
Ground floor			46.49	0.15	6.97		
External wall			80.65	0.21	16.94		
Party wall			42.49	0.00	0.00		
Roof			46.50	0.11	5.12		
Total area of external elements ΣA, m ²			190.18				
Fabric heat loss, W/K = Σ(A x U)						(26)...(30) + (32) =	49.59 (33)
Heat capacity Cm = Σ(A x k)						(28)...(30) + (32) + (32a)...(32e) =	N/A (34)
Thermal mass parameter (TMP) in kJ/m ² K							250.00 (35)
Thermal bridges: Σ(L x Ψ) calculated using Appendix K							8.07 (36)
Total fabric heat loss						(33) + (36) =	57.67 (37)

	Jan	Feb	Mar	Apr	May	Jun	Jul	Aug	Sep	Oct	Nov	Dec
Ventilation heat loss calculated monthly 0.33 x (25)m x (5)	46.38	46.07	45.77	44.33	44.06	42.81	42.81	42.58	43.30	44.06	44.61	45.17

	Jan	Feb	Mar	Apr	May	Jun	Jul	Aug	Sep	Oct	Nov	Dec
Heat transfer coefficient, W/K (37)m + (38)m	104.05	103.74	103.44	102.00	101.73	100.48	100.48	100.25	100.96	101.73	102.28	102.84
Average = Σ(39)1...12/12 =	102.00 (39)											

	Jan	Feb	Mar	Apr	May	Jun	Jul	Aug	Sep	Oct	Nov	Dec
Heat loss parameter (HLP), W/m ² K (39)m ÷ (4)	1.12	1.12	1.11	1.10	1.09	1.08	1.08	1.08	1.09	1.09	1.10	1.11
Average = Σ(40)1...12/12 =	1.10 (40)											

	Jan	Feb	Mar	Apr	May	Jun	Jul	Aug	Sep	Oct	Nov	Dec
Number of days in month (Table 1a)	31.00	28.00	31.00	30.00	31.00	30.00	31.00	31.00	30.00	31.00	30.00	31.00

4. Water heating energy requirement

Assumed occupancy, N	2.66 (42)
Annual average hot water usage in litres per day Vd,average = (25 x N) + 36	97.48 (43)
Hot water usage in litres per day for each month Vd,m = factor from Table 1c x (43)	107.23 103.33 99.43 95.53 91.63 87.73 87.73 91.63 95.53 99.43 103.33 107.23
Σ(44)1...12 =	1169.78 (44)

	Jan	Feb	Mar	Apr	May	Jun	Jul	Aug	Sep	Oct	Nov	Dec
Energy content of hot water used = 4.18 x Vd,m x nm x Tm/3600 kWh/month (see Tables 1b, 1c 1d)	159.02	139.08	143.52	125.12	120.06	103.60	96.00	110.16	111.48	129.92	141.81	154.00
Σ(45)1...12 =	1533.76 (45)											

	Jan	Feb	Mar	Apr	May	Jun	Jul	Aug	Sep	Oct	Nov	Dec
Distribution loss 0.15 x (45)m	23.85	20.86	21.53	18.77	18.01	15.54	14.40	16.52	16.72	19.49	21.27	23.10

	Jan	Feb	Mar	Apr	May	Jun	Jul	Aug	Sep	Oct	Nov	Dec
Water storage loss calculated for each month (55) x (41)m	0.00	0.00	0.00	0.00	0.00	0.00	0.00	0.00	0.00	0.00	0.00	0.00

If the vessel contains dedicated solar storage or dedicated WWHRS (56)m x [(47) - Vs] ÷ (47), else (56)	0.00 0.00 0.00 0.00 0.00 0.00 0.00 0.00 0.00 0.00 0.00 0.00
Σ(57)1...12 =	0.00 (57)

	Jan	Feb	Mar	Apr	May	Jun	Jul	Aug	Sep	Oct	Nov	Dec
Primary circuit loss for each month from Table 3	0.00	0.00	0.00	0.00	0.00	0.00	0.00	0.00	0.00	0.00	0.00	0.00

	Jan	Feb	Mar	Apr	May	Jun	Jul	Aug	Sep	Oct	Nov	Dec
Combi loss for each month from Table 3a, 3b or 3c	21.05	18.99	20.98	20.22	20.84	20.10	20.73	20.80	20.16	20.92	20.32	21.03



Total heat required for water heating calculated for each month $0.85 \times (45)m + (46)m + (57)m + (59)m + (61)m$

180.07	158.07	164.49	145.34	140.89	123.70	116.73	130.96	131.64	150.84	162.13	175.03	(62)
--------	--------	--------	--------	--------	--------	--------	--------	--------	--------	--------	--------	------

Solar DHW input calculated using Appendix G or Appendix H

-55.23	-48.60	-49.60	-40.81	-37.89	-31.26	-26.46	-32.03	-32.97	-40.75	-47.21	-53.38	(63)
--------	--------	--------	--------	--------	--------	--------	--------	--------	--------	--------	--------	------

Output from water heater for each month (kWh/month) (62)m + (63)m

124.83	109.47	114.89	104.53	103.00	92.44	90.27	98.93	98.67	110.08	114.92	121.64	(64)
$\sum(64)1...12 =$											1283.69	

Heat gains from water heating (kWh/month) $0.25 \times [0.85 \times (45)m + (61)m] + 0.8 \times [(46)m + (57)m + (59)m]$

58.14	50.99	52.96	46.66	45.13	39.47	37.10	41.83	42.11	48.43	52.23	56.46	(65)
-------	-------	-------	-------	-------	-------	-------	-------	-------	-------	-------	-------	------

5. Internal gains

	Jan	Feb	Mar	Apr	May	Jun	Jul	Aug	Sep	Oct	Nov	Dec	
Metabolic gains (Table 5)	133.22	133.22	133.22	133.22	133.22	133.22	133.22	133.22	133.22	133.22	133.22	133.22	(66)

Lighting gains (calculated in Appendix L, equation L9 or L9a), also see Table 5

22.85	20.29	16.50	12.50	9.34	7.89	8.52	11.08	14.87	18.87	22.03	23.48	(67)
-------	-------	-------	-------	------	------	------	-------	-------	-------	-------	-------	------

Appliance gains (calculated in Appendix L, equation L13 or L13a), also see Table 5

244.47	247.01	240.62	227.01	209.83	193.68	182.89	180.36	186.75	200.36	217.54	233.69	(68)
--------	--------	--------	--------	--------	--------	--------	--------	--------	--------	--------	--------	------

Cooking gains (calculated in Appendix L, equation L15 or L15a), also see Table 5

36.32	36.32	36.32	36.32	36.32	36.32	36.32	36.32	36.32	36.32	36.32	36.32	(69)
-------	-------	-------	-------	-------	-------	-------	-------	-------	-------	-------	-------	------

Pump and fan gains (Table 5a)

3.00	3.00	3.00	3.00	3.00	3.00	3.00	3.00	3.00	3.00	3.00	3.00	(70)
------	------	------	------	------	------	------	------	------	------	------	------	------

Losses e.g. evaporation (Table 5)

-106.58	-106.58	-106.58	-106.58	-106.58	-106.58	-106.58	-106.58	-106.58	-106.58	-106.58	-106.58	(71)
---------	---------	---------	---------	---------	---------	---------	---------	---------	---------	---------	---------	------

Water heating gains (Table 5)

78.14	75.88	71.19	64.80	60.66	54.82	49.87	56.22	58.48	65.09	72.54	75.89	(72)
-------	-------	-------	-------	-------	-------	-------	-------	-------	-------	-------	-------	------

Total internal gains (66)m + (67)m + (68)m + (69)m + (70)m + (71)m + (72)m

411.43	409.15	394.28	370.27	345.79	322.35	307.25	313.62	326.06	350.29	378.08	399.03	(73)
--------	--------	--------	--------	--------	--------	--------	--------	--------	--------	--------	--------	------

6. Solar gains

	Access factor Table 6d	Area m ²	Solar flux W/m ²	g specific data or Table 6b	FF specific data or Table 6c	Gains W	
West	0.77	5.81	19.64	0.9	0.63	0.70	= 34.87 (80)
East	0.77	8.71	19.64	0.9	0.63	0.70	= 52.28 (76)

Solar gains in watts $\sum(74)m... (82)m$

87.15	170.49	280.77	409.49	501.85	513.73	489.09	420.12	326.55	202.30	108.67	71.67	(83)
-------	--------	--------	--------	--------	--------	--------	--------	--------	--------	--------	-------	------

Total gains - internal and solar (73)m + (83)m

498.58	579.64	675.05	779.76	847.64	836.09	796.34	733.74	652.62	552.59	486.75	470.70	(84)
--------	--------	--------	--------	--------	--------	--------	--------	--------	--------	--------	--------	------

7. Mean internal temperature (heating season)

Temperature during heating periods in the living area from Table 9, Th1(°C) 21.00 (85)

	Jan	Feb	Mar	Apr	May	Jun	Jul	Aug	Sep	Oct	Nov	Dec	
Utilisation factor for gains for living area n1,m (see Table 9a)	1.00	1.00	0.99	0.96	0.88	0.71	0.54	0.61	0.87	0.98	1.00	1.00	(86)

Mean internal temp of living area T1 (steps 3 to 7 in Table 9c)

19.74	19.89	20.16	20.51	20.80	20.95	20.99	20.98	20.87	20.48	20.05	19.72	(87)
-------	-------	-------	-------	-------	-------	-------	-------	-------	-------	-------	-------	------

Temperature during heating periods in the rest of dwelling from Table 9, Th2(°C)

19.99	19.99	19.99	20.00	20.01	20.02	20.02	20.02	20.01	20.01	20.00	20.00	(88)
-------	-------	-------	-------	-------	-------	-------	-------	-------	-------	-------	-------	------

Utilisation factor for gains for rest of dwelling n2,m

1.00	1.00	0.99	0.95	0.84	0.63	0.43	0.49	0.80	0.98	1.00	1.00	(89)
------	------	------	------	------	------	------	------	------	------	------	------	------

Mean internal temperature in the rest of dwelling T2 (follow steps 3 to 7 in Table 9c)

18.30	18.52	18.91	19.42	19.80	19.99	20.01	20.01	19.90	19.38	18.76	18.27	(90)
-------	-------	-------	-------	-------	-------	-------	-------	-------	-------	-------	-------	------

Living area fraction

Living area ÷ (4) = 0.22 (91)

Mean internal temperature for the whole dwelling fLA x T1 + (1 - fLA) x T2

18.61	18.82	19.18	19.66	20.02	20.20	20.23	20.23	20.11	19.62	19.04	18.59	(92)
-------	-------	-------	-------	-------	-------	-------	-------	-------	-------	-------	-------	------

Apply adjustment to the mean internal temperature from Table 4e where appropriate

18.46	18.67	19.03	19.51	19.87	20.05	20.08	20.08	19.96	19.47	18.89	18.44	(93)
-------	-------	-------	-------	-------	-------	-------	-------	-------	-------	-------	-------	------

8. Space heating requirement

	Jan	Feb	Mar	Apr	May	Jun	Jul	Aug	Sep	Oct	Nov	Dec	
Utilisation factor for gains, ηm	1.00	0.99	0.98	0.94	0.83	0.63	0.44	0.50	0.80	0.97	0.99	1.00	(94)

Useful gains, ηmGm, W (94)m x (84)m

497.32	576.32	663.69	734.47	704.63	525.69	346.88	363.58	519.92	535.32	484.17	469.81	(95)
--------	--------	--------	--------	--------	--------	--------	--------	--------	--------	--------	--------	------

Monthly average external temperature from Table U1

4.30	4.90	6.50	8.90	11.70	14.60	16.60	16.40	14.10	10.60	7.10	4.20	(96)
------	------	------	------	-------	-------	-------	-------	-------	-------	------	------	------

Heat loss rate for mean internal temperature, Lm, W [(39)m x (96)m]

1473.80	1428.33	1295.96	1081.99	831.37	547.34	349.42	368.42	591.90	902.44	1205.62	1464.60	(97)
---------	---------	---------	---------	--------	--------	--------	--------	--------	--------	---------	---------	------

Space heating requirement, kWh/month $0.024 \times [(97)m - (95)m] \times (41)m$

726.50	572.55	470.41	250.21	94.29	0.00	0.00	0.00	0.00	273.14	519.45	740.13	(98)
$\sum(98)1...5, 10...12 =$											3646.68	

Space heating requirement kWh/m²/year

(98) ÷ (4) = 39.22 (99)

9a. Energy requirements - individual heating systems including micro-CHP

Space heating

Fraction of space heat from secondary/supplementary system (table 11)	0.00 (201)
Fraction of space heat from main system(s)	1 - (201) = 1.00 (202)
Fraction of space heat from main system 2	0.00 (203)
Fraction of total space heat from main system 1	(202) x [1 - (203)] = 1.00 (204)
Fraction of total space heat from main system 2	(202) x (203) = 0.00 (205)
Efficiency of main system 1 (%)	93.00 (206)

	Jan	Feb	Mar	Apr	May	Jun	Jul	Aug	Sep	Oct	Nov	Dec	
Space heating fuel (main system 1), kWh/month	781.18	615.65	505.82	269.05	101.39	0.00	0.00	0.00	293.70	558.54	795.83	(211)	
$\sum(211)1...5, 10...12 =$											3921.16		

Water heating

Efficiency of water heater	89.50	89.45	89.33	89.00	88.25	86.70	86.70	86.70	86.70	89.03	89.38	89.52	(217)
----------------------------	-------	-------	-------	-------	-------	-------	-------	-------	-------	-------	-------	-------	-------

Water heating fuel, kWh/month

139.48	122.38	128.61	117.45	116.72	106.62	104.12	114.10	113.81	123.65	128.57	135.88	(219)
$\sum(219a)1...12 =$											1451.39	

Annual totals

Space heating fuel - main system 1	3921.16
Water heating fuel	1451.39
Electricity for pumps, fans and electric keep-hot (Table 4f)	
central heating pump or water pump within warm air heating unit	30.00 (230c)

boiler flue fan	45.00	(230e)
Total electricity for the above, kWh/year	75.00	(231)
Electricity for lighting (Appendix L)	403.53	(232)
Total delivered energy for all uses	(211)...(221) + (231) + (232)...(237b) = 5851.08	(238)

10a. Fuel costs - individual heating systems including micro-CHP

	Fuel kWh/year		Fuel price		Fuel cost £/year	
Space heating - main system 1	3921.16	x	3.48	x 0.01 =	136.46	(240)
Water heating	1451.39	x	3.48	x 0.01 =	50.51	(247)
Pumps and fans	75.00	x	13.19	x 0.01 =	9.89	(249)
Electricity for lighting	403.53	x	13.19	x 0.01 =	53.23	(250)
Additional standing charges					120.00	(251)
Total energy cost				(240)...(242) + (245)...(254) =	370.08	(255)

11a. SAP rating - individual heating systems including micro-CHP

Energy cost deflator (Table 12)	0.42	(256)
Energy cost factor (ECF)	1.13	(257)
SAP value	84.29	
SAP rating (section 13)	84	(258)
SAP band	B	

12a. CO₂ emissions - individual heating systems including micro-CHP

	Energy kWh/year		Emission factor kg CO ₂ /kWh		Emissions kg CO ₂ /year	
Space heating - main system 1	3921.16	x	0.216	=	846.97	(261)
Water heating	1451.39	x	0.216	=	313.50	(264)
Space and water heating				(261) + (262) + (263) + (264) =	1160.47	(265)
Pumps and fans	75.00	x	0.519	=	38.93	(267)
Electricity for lighting	403.53	x	0.519	=	209.43	(268)
Total CO ₂ , kg/year				(265)...(271) =	1408.83	(272)
Dwelling CO ₂ emission rate				(272) ÷ (4) =	15.15	(273)
EI value					86.32	
EI rating (section 14)					86	(274)
EI band					B	

13a. Primary energy - individual heating systems including micro-CHP

	Energy kWh/year		Primary factor		Primary Energy kWh/year	
Space heating - main system 1	3921.16	x	1.22	=	4783.82	(261)
Water heating	1451.39	x	1.22	=	1770.70	(264)
Space and water heating				(261) + (262) + (263) + (264) =	6554.52	(265)
Pumps and fans	75.00	x	3.07	=	230.25	(267)
Electricity for lighting	403.53	x	3.07	=	1238.82	(268)
Primary energy kWh/year					8023.59	(272)
Dwelling primary energy rate kWh/m ² /year					86.28	(273)

DER Worksheet Design - Draft



This design submission has been carried out using Approved SAP software. It has been prepared from plans and specifications and may not reflect the property as constructed.

Assessor name	Mr Simon Gowing	Assessor number	9641
Client		Last modified	29/10/2018
Address	LANGFORD Oxford Road, Bodicaote, OX15		

1. Overall dwelling dimensions

	Area (m ²)	Average storey height (m)	Volume (m ³)
Lowest occupied +1	50.58 (1a) x 50.58 (1b)	2.39 (2a) x 2.61 (2b)	120.89 (3a) x 132.01 (3b)
Total floor area	(1a) + (1b) + (1c) + (1d)...(1n) = 101.16 (4)		
Dwelling volume		(3a) + (3b) + (3c) + (3d)...(3n) =	252.90 (5)

2. Ventilation rate

		m ³ per hour
Number of chimneys	0 x 40 =	0 (6a)
Number of open flues	0 x 20 =	0 (6b)
Number of intermittent fans	4 x 10 =	40 (7a)
Number of passive vents	0 x 10 =	0 (7b)
Number of flueless gas fires	0 x 40 =	0 (7c)
Infiltration due to chimneys, flues, fans, PSVs	(6a) + (6b) + (7a) + (7b) + (7c) = 40 ÷ (5) =	0.16 (8)
Air permeability value, q ₅₀ , expressed in cubic metres per hour per square metre of envelope area		5.00 (17)
If based on air permeability value, then (18) = [(17) ÷ 20] + (8), otherwise (18) = (16)		0.41 (18)
Number of sides on which the dwelling is sheltered		1 (19)
Shelter factor	1 - [0.075 x (19)] =	0.93 (20)
Infiltration rate incorporating shelter factor	(18) x (20) =	0.38 (21)

Infiltration rate modified for monthly wind speed:

	Jan	Feb	Mar	Apr	May	Jun	Jul	Aug	Sep	Oct	Nov	Dec
Monthly average wind speed from Table U2	5.10	5.00	4.90	4.40	4.30	3.80	3.80	3.70	4.00	4.30	4.50	4.70
Wind factor (22)m ÷ 4	1.28	1.25	1.23	1.10	1.08	0.95	0.95	0.93	1.00	1.08	1.13	1.18
Adjusted infiltration rate (allowing for shelter and wind factor) (21) x (22a)m	0.48	0.47	0.46	0.42	0.41	0.36	0.36	0.35	0.38	0.41	0.42	0.44

Calculate effective air change rate for the applicable case:

If mechanical ventilation: air change rate through system	N/A (23a)
If balanced with heat recovery: efficiency in % allowing for in-use factor from Table 4h	N/A (23c)
d) natural ventilation or whole house positive input ventilation from loft	0.62 0.61 0.61 0.59 0.58 0.56 0.56 0.56 0.57 0.58 0.59 0.60 (24d)

Effective air change rate - enter (24a) or (24b) or (24c) or (24d) in (25)



0.62	0.61	0.61	0.59	0.58	0.56	0.56	0.56	0.57	0.58	0.59	0.60
------	------	------	------	------	------	------	------	------	------	------	------

(25)

3. Heat losses and heat loss parameter

Element	Gross area, m ²	Openings m ²	Net area A, m ²	U-value W/m ² K	A x U W/K	κ-value, kJ/m ² .K	A x κ, kJ/K
Window			14.68	1.24	18.14		
Door			2.13	1.30	2.77		
Ground floor			50.58	0.15	7.59		
External wall			129.64	0.21	27.22		
Roof			50.58	0.11	5.56		
Total area of external elements ΣA, m ²			247.61				
Fabric heat loss, W/K = Σ(A x U)					(26)...(30) + (32) = 61.28		
Heat capacity Cm = Σ(A x κ)					(28)...(30) + (32) + (32a)...(32e) = N/A		
Thermal mass parameter (TMP) in kJ/m ² K							191.00
Thermal bridges: Σ(L x Ψ) calculated using Appendix K							8.43
Total fabric heat loss					(33) + (36) = 69.71		

	Jan	Feb	Mar	Apr	May	Jun	Jul	Aug	Sep	Oct	Nov	Dec
Ventilation heat loss calculated monthly 0.33 x (25)m x (5)	51.40	51.02	50.65	48.93	48.60	47.10	47.10	46.82	47.68	48.60	49.26	49.94

(38)

	Jan	Feb	Mar	Apr	May	Jun	Jul	Aug	Sep	Oct	Nov	Dec
Heat transfer coefficient, W/K (37)m + (38)m	121.11	120.73	120.37	118.64	118.31	116.81	116.81	116.53	117.39	118.31	118.97	119.65
Average = Σ(39)1...12/12 =	118.63											

(39)

	Jan	Feb	Mar	Apr	May	Jun	Jul	Aug	Sep	Oct	Nov	Dec
Heat loss parameter (HLP), W/m ² K (39)m ÷ (4)	1.20	1.19	1.19	1.17	1.17	1.15	1.15	1.15	1.16	1.17	1.18	1.18
Average = Σ(40)1...12/12 =	1.17											

(40)

	Jan	Feb	Mar	Apr	May	Jun	Jul	Aug	Sep	Oct	Nov	Dec
Number of days in month (Table 1a)	31.00	28.00	31.00	30.00	31.00	30.00	31.00	31.00	30.00	31.00	30.00	31.00

(40)

4. Water heating energy requirement

Assumed occupancy, N	2.75
Annual average hot water usage in litres per day Vd,average = (25 x N) + 36	99.51

(42)

(43)

	Jan	Feb	Mar	Apr	May	Jun	Jul	Aug	Sep	Oct	Nov	Dec
Hot water usage in litres per day for each month Vd,m = factor from Table 1c x (43)	109.46	105.48	101.50	97.52	93.54	89.56	89.56	93.54	97.52	101.50	105.48	109.46
Σ(44)1...12 =	1194.15											

(44)

	Jan	Feb	Mar	Apr	May	Jun	Jul	Aug	Sep	Oct	Nov	Dec
Energy content of hot water used = 4.18 x Vd,m x nm x Tm/3600 kWh/month (see Tables 1b, 1c 1d)	162.33	141.98	146.51	127.73	122.56	105.76	98.00	112.46	113.80	132.62	144.77	157.21
Σ(45)1...12 =	1565.72											

(45)

	Jan	Feb	Mar	Apr	May	Jun	Jul	Aug	Sep	Oct	Nov	Dec
Distribution loss 0.15 x (45)m	24.35	21.30	21.98	19.16	18.38	15.86	14.70	16.87	17.07	19.89	21.72	23.58

(46)

Storage volume (litres) including any solar or WWHRs storage within same vessel	250.00
---	--------

(47)

Water storage loss:	
a) If manufacturer's declared loss factor is known (kWh/day)	1.67
Temperature factor from Table 2b	0.54
Energy lost from water storage (kWh/day) (48) x (49)	0.90
Enter (50) or (54) in (55)	0.90

(48)

(49)

(50)

(55)

	Jan	Feb	Mar	Apr	May	Jun	Jul	Aug	Sep	Oct	Nov	Dec
Water storage loss calculated for each month (55) x (41)m	27.96	25.25	27.96	27.05	27.96	27.05	27.96	27.96	27.05	27.96	27.05	27.96

(56)

If the vessel contains dedicated solar storage or dedicated WWHRs (56)m x [(47) - Vs] ÷ (47), else (56)

27.96	25.25	27.96	27.05	27.96	27.05	27.96	27.96	27.05	27.96	27.05	27.96
-------	-------	-------	-------	-------	-------	-------	-------	-------	-------	-------	-------

(57)

Primary circuit loss for each month from Table 3

23.26	21.01	23.26	22.51	23.26	22.51	23.26	23.26	22.51	23.26	22.51	23.26
-------	-------	-------	-------	-------	-------	-------	-------	-------	-------	-------	-------

(59)

Combi loss for each month from Table 3a, 3b or 3c

0.00	0.00	0.00	0.00	0.00	0.00	0.00	0.00	0.00	0.00	0.00	0.00
------	------	------	------	------	------	------	------	------	------	------	------

(61)

Total heat required for water heating calculated for each month 0.85 x (45)m + (46)m + (57)m + (59)m + (61)m

213.55	188.24	197.73	177.29	173.78	155.32	149.22	163.68	163.37	183.84	194.33	208.43
--------	--------	--------	--------	--------	--------	--------	--------	--------	--------	--------	--------

(62)

Solar DHW input calculated using Appendix G or Appendix H

-56.76	-49.94	-50.97	-41.93	-38.93	-32.12	-27.18	-32.91	-33.87	-41.87	-48.51	-54.86
--------	--------	--------	--------	--------	--------	--------	--------	--------	--------	--------	--------

(63)

Output from water heater for each month (kWh/month) (62)m + (63)m

156.79	138.30	146.75	135.36	134.84	123.21	122.04	130.77	129.50	141.97	145.83	153.57
--------	--------	--------	--------	--------	--------	--------	--------	--------	--------	--------	--------

(64)

Σ(64)1...12 = 1658.93

Heat gains from water heating (kWh/month) 0.25 x [0.85 x (45)m + (61)m] + 0.8 x [(46)m + (57)m + (59)m]

94.95	84.22	89.69	82.12	81.73	74.82	73.56	78.37	77.49	85.07	87.79	93.25
-------	-------	-------	-------	-------	-------	-------	-------	-------	-------	-------	-------

(65)

5. Internal gains

	Jan	Feb	Mar	Apr	May	Jun	Jul	Aug	Sep	Oct	Nov	Dec
Metabolic gains (Table 5)	137.50	137.50	137.50	137.50	137.50	137.50	137.50	137.50	137.50	137.50	137.50	137.50

(66)

Lighting gains (calculated in Appendix L, equation L9 or L9a), also see Table 5

24.50	21.76	17.70	13.40	10.02	8.46	9.14	11.88	15.94	20.24	23.62	25.18
-------	-------	-------	-------	-------	------	------	-------	-------	-------	-------	-------

(67)

Appliance gains (calculated in Appendix L, equation L13 or L13a), also see Table 5

258.19	260.87	254.12	239.74	221.60	204.55	193.16	190.48	197.23	211.60	229.75	246.80
--------	--------	--------	--------	--------	--------	--------	--------	--------	--------	--------	--------

(68)

Cooking gains (calculated in Appendix L, equation L15 or L15a), also see Table 5

36.75	36.75	36.75	36.75	36.75	36.75	36.75	36.75	36.75	36.75	36.75	36.75
-------	-------	-------	-------	-------	-------	-------	-------	-------	-------	-------	-------

(69)

Pump and fan gains (Table 5a)

3.00	3.00	3.00	3.00	3.00	3.00	3.00	3.00	3.00	3.00	3.00	3.00
------	------	------	------	------	------	------	------	------	------	------	------

(70)

Losses e.g. evaporation (Table 5)

-110.00	-110.00	-110.00	-110.00	-110.00	-110.00	-110.00	-110.00	-110.00	-110.00	-110.00	-110.00
---------	---------	---------	---------	---------	---------	---------	---------	---------	---------	---------	---------

(71)

Water heating gains (Table 5)

127.62	125.32	120.55	114.06	109.85	103.91	98.87	105.33	107.63	114.34	121.93	125.33
--------	--------	--------	--------	--------	--------	-------	--------	--------	--------	--------	--------

(72)

Total internal gains (66)m + (67)m + (68)m + (69)m + (70)m + (71)m + (72)m

477.56	475.20	459.62	434.45	408.71	384.17	368.41	374.94	388.05	413.44	442.55	464.56
--------	--------	--------	--------	--------	--------	--------	--------	--------	--------	--------	--------

(73)

6. Solar gains

	Access factor Table 6d	Area m ²	Solar flux W/m ²	g specific data or Table 6b	FF specific data or Table 6c	Gains W						
South	0.77	5.71	46.75	0.63	0.70	81.58						
North	0.77	8.97	10.63	0.63	0.70	29.15						
Solar gains in watts Σ(74)m...(82)m	110.73	189.32	264.86	344.41	405.28	412.18	393.20	345.46	291.61	210.43	132.67	94.80

(78)

(74)

(83)

Total gains - internal and solar (73)m + (83)m

588.30	664.53	724.48	778.86	813.99	796.35	761.62	720.40	679.65	623.86	575.21	559.36
--------	--------	--------	--------	--------	--------	--------	--------	--------	--------	--------	--------

(84)

7. Mean internal temperature (heating season)

Temperature during heating periods in the living area from Table 9, Th1(°C)	21.00
---	-------

(85)

	Jan	Feb	Mar	Apr	May	Jun	Jul	Aug	Sep	Oct	Nov	Dec
Utilisation factor for gains for living area n1,m (see Table 9a)												

0.99	0.99	0.98	0.96	0.90	0.78	0.62	0.67	0.87	0.97	0.99	1.00	(86)
Mean internal temp of living area T1 (steps 3 to 7 in Table 9c)												
19.38	19.55	19.83	20.22	20.58	20.85	20.96	20.94	20.75	20.29	19.77	19.35	(87)
Temperature during heating periods in the rest of dwelling from Table 9, Th2(°C)												
19.92	19.93	19.93	19.94	19.94	19.96	19.96	19.96	19.95	19.94	19.94	19.93	(88)
Utilisation factor for gains for rest of dwelling n2,m												
0.99	0.99	0.98	0.95	0.87	0.70	0.50	0.55	0.81	0.95	0.99	0.99	(89)
Mean internal temperature in the rest of dwelling T2 (follow steps 3 to 7 in Table 9c)												
17.76	18.01	18.42	18.99	19.49	19.84	19.93	19.93	19.72	19.09	18.34	17.73	(90)
Living area fraction Living area ÷ (4) = 0.14 (91)												
Mean internal temperature for the whole dwelling fLA x T1 +(1 - fLA) x T2												
17.99	18.23	18.62	19.16	19.65	19.98	20.08	20.07	19.87	19.26	18.55	17.96	(92)
Apply adjustment to the mean internal temperature from Table 4e where appropriate												
17.84	18.08	18.47	19.01	19.50	19.83	19.93	19.92	19.72	19.11	18.40	17.81	(93)

8. Space heating requirement

	Jan	Feb	Mar	Apr	May	Jun	Jul	Aug	Sep	Oct	Nov	Dec	
Utilisation factor for gains, ηm													
	0.99	0.98	0.97	0.93	0.85	0.68	0.49	0.54	0.79	0.94	0.98	0.99	(94)
Useful gains, ηmGm, W (94)m x (84)m													
	581.71	652.20	700.23	724.43	690.06	545.40	376.02	391.18	536.56	585.90	564.08	554.17	(95)
Monthly average external temperature from Table U1													
	4.30	4.90	6.50	8.90	11.70	14.60	16.60	16.40	14.10	10.60	7.10	4.20	(96)
Heat loss rate for mean internal temperature, Lm, W [(39)m x ((93)m - (96)m)]													
	1639.60	1590.89	1441.02	1199.71	922.68	611.03	388.84	410.09	659.19	1007.28	1343.92	1628.74	(97)
Space heating requirement, kWh/month 0.024 x ((97)m - (95)m) x (41)m													
	787.07	630.80	551.15	342.20	173.06	0.00	0.00	0.00	0.00	313.50	561.48	799.48	
	Σ(98)1...5, 10...12 =											4158.75 (98)	
Space heating requirement kWh/m ² /year (98) ÷ (4) =													41.11 (99)

9a. Energy requirements - individual heating systems including micro-CHP

Space heating

Fraction of space heat from secondary/supplementary system (table 11)		0.00	(201)										
Fraction of space heat from main system(s)	1 - (201) =	1.00	(202)										
Fraction of space heat from main system 2		0.00	(202)										
Fraction of total space heat from main system 1	(202) x [1 - (203)] =	1.00	(204)										
Fraction of total space heat from main system 2	(202) x (203) =	0.00	(205)										
Efficiency of main system 1 (%)		93.00	(206)										
Space heating fuel (main system 1), kWh/month													
	Jan	Feb	Mar	Apr	May	Jun	Jul	Aug	Sep	Oct	Nov	Dec	
	846.31	678.28	592.63	367.96	186.09	0.00	0.00	0.00	0.00	337.10	603.75	859.65	
	Σ(211)1...5, 10...12 =											4471.77 (211)	

Water heating

Efficiency of water heater													
	88.03	87.87	87.52	86.68	84.98	79.30	79.30	79.30	79.30	86.37	87.56	88.08	(217)
Water heating fuel, kWh/month													
	178.12	157.39	167.69	156.15	158.68	155.37	153.90	164.90	163.30	164.38	166.54	174.34	
	Σ(219a)1...12 =											1960.76 (219)	

Annual totals

Space heating fuel - main system 1		4471.77	
Water heating fuel		1960.76	
Electricity for pumps, fans and electric keep-hot (Table 4f)			
central heating pump or water pump within warm air heating unit		30.00	(230c)
boiler flue fan		45.00	(230e)
Total electricity for the above, kWh/year		75.00	(231)
Electricity for lighting (Appendix L)		432.73	(232)
Total delivered energy for all uses	(211)...(221) + (231) + (232)...(237b) =	6940.26	(238)

10a. Fuel costs - individual heating systems including micro-CHP

	Fuel kWh/year		Fuel price		Fuel cost £/year	
Space heating - main system 1	4471.77	x	3.48	x 0.01 =	155.62	(240)
Water heating	1960.76	x	3.48	x 0.01 =	68.23	(247)
Pumps and fans	75.00	x	13.19	x 0.01 =	9.89	(249)
Electricity for lighting	432.73	x	13.19	x 0.01 =	57.08	(250)
Additional standing charges					120.00	(251)
Total energy cost				(240)...(242) + (245)...(254) =	410.82	(255)

11a. SAP rating - individual heating systems including micro-CHP

Energy cost deflator (Table 12)		0.42	(256)
Energy cost factor (ECF)		1.18	(257)
SAP value		83.53	
SAP rating (section 13)		84	(258)
SAP band		B	

12a. CO₂ emissions - individual heating systems including micro-CHP

	Energy kWh/year		Emission factor kg CO ₂ /kWh		Emissions kg CO ₂ /year	
Space heating - main system 1	4471.77	x	0.216	=	965.90	(261)
Water heating	1960.76	x	0.216	=	423.52	(264)
Space and water heating				(261) + (262) + (263) + (264) =	1389.43	(265)
Pumps and fans	75.00	x	0.519	=	38.93	(267)
Electricity for lighting	432.73	x	0.519	=	224.59	(268)
Total CO ₂ , kg/year				(265)...(271) =	1652.94	(272)
Dwelling CO ₂ emission rate				(272) ÷ (4) =	16.34	(273)
EI value					84.85	
EI rating (section 14)					85	(274)
EI band					B	

13a. Primary energy - individual heating systems including micro-CHP

	Energy kWh/year		Primary factor		Primary Energy kWh/year	
Space heating - main system 1	4471.77	x	1.22	=	5455.56	(261)
Water heating	1960.76	x	1.22	=	2392.12	(264)
Space and water heating				(261) + (262) + (263) + (264) =	7847.68	(265)
Pumps and fans	75.00	x	3.07	=	230.25	(267)
Electricity for lighting	432.73	x	3.07	=	1328.50	(268)
Primary energy kWh/year					9406.43	(272)

DER Worksheet Design - Draft



This design submission has been carried out using Approved SAP software. It has been prepared from plans and specifications and may not reflect the property as constructed.

Assessor name	Mr Simon Gowing	Assessor number	9641
Client		Last modified	29/10/2018
Address	RADLEY Oxford Road, Bodicaote, OX15		

1. Overall dwelling dimensions

	Area (m ²)	Average storey height (m)	Volume (m ³)
Lowest occupied	74.27 (1a) x	2.37 (2a) =	176.02 (3a)
+1	72.78 (1b) x	2.61 (2b) =	189.96 (3b)
Total floor area	(1a) + (1b) + (1c) + (1d)...(1n) =		147.05 (4)
Dwelling volume	(3a) + (3b) + (3c) + (3d)...(3n) =		365.98 (5)

2. Ventilation rate

	m ³ per hour
Number of chimneys	0 x 40 = 0 (6a)
Number of open flues	0 x 20 = 0 (6b)
Number of intermittent fans	5 x 10 = 50 (7a)
Number of passive vents	0 x 10 = 0 (7b)
Number of flueless gas fires	0 x 40 = 0 (7c)

Infiltration due to chimneys, flues, fans, PSVs (6a) + (6b) + (7a) + (7b) + (7c) = 50 ÷ (5) = 0.14 (8)

If a pressurisation test has been carried out or is intended, proceed to (17), otherwise continue from (9) to (16)

Air permeability value, q50, expressed in cubic metres per hour per square metre of envelope area 5.00 (17)

If based on air permeability value, then (18) = [(17) ÷ 20] + (8), otherwise (18) = (16) 0.39 (18)

Number of sides on which the dwelling is sheltered 0 (19)

Shelter factor 1 - [0.075 x (19)] = 1.00 (20)

Infiltration rate incorporating shelter factor (18) x (20) = 0.39 (21)

Infiltration rate modified for monthly wind speed:

	Jan	Feb	Mar	Apr	May	Jun	Jul	Aug	Sep	Oct	Nov	Dec
Monthly average wind speed from Table U2	5.10	5.00	4.90	4.40	4.30	3.80	3.80	3.70	4.00	4.30	4.50	4.70

	Jan	Feb	Mar	Apr	May	Jun	Jul	Aug	Sep	Oct	Nov	Dec
Wind factor (22)m ÷ 4	1.28	1.25	1.23	1.10	1.08	0.95	0.95	0.93	1.00	1.08	1.13	1.18

	Jan	Feb	Mar	Apr	May	Jun	Jul	Aug	Sep	Oct	Nov	Dec
Adjusted infiltration rate (allowing for shelter and wind factor) (21) x (22a)m	0.49	0.48	0.47	0.43	0.42	0.37	0.37	0.36	0.39	0.42	0.43	0.45

Calculate effective air change rate for the applicable case:

If mechanical ventilation: air change rate through system N/A (23a)

If balanced with heat recovery: efficiency in % allowing for in-use factor from Table 4h N/A (23c)

	Jan	Feb	Mar	Apr	May	Jun	Jul	Aug	Sep	Oct	Nov	Dec
d) natural ventilation or whole house positive input ventilation from loft	0.62	0.62	0.61	0.59	0.59	0.57	0.57	0.56	0.57	0.59	0.59	0.60

Effective air change rate - enter (24a) or (24b) or (24c) or (24d) in (25)



0.62	0.62	0.61	0.59	0.59	0.57	0.57	0.56	0.57	0.59	0.59	0.60
------	------	------	------	------	------	------	------	------	------	------	------

(25)

3. Heat losses and heat loss parameter

Element	Gross area, m ²	Openings m ²	Net area A, m ²	U-value W/m ² K	A x U W/K	k-value, kJ/m ² .K	A x k, kJ/K
Window			28.76	1.24	35.54		
Door			2.03	1.30	2.64		
Ground floor			74.27	0.15	11.14		
External wall			154.73	0.21	32.49		
Roof			72.78	0.11	8.01		
Roof			1.50	0.21	0.32		
Total area of external elements ΣA, m ²			334.07				
Fabric heat loss, W/K = Σ(A x U)					(26)...(30) + (32) =	90.13	
Heat capacity Cm = Σ(A x k)					(28)...(30) + (32) + (32a)...(32e) =	N/A	
Thermal mass parameter (TMP) in kJ/m ² K						191.00	
Thermal bridges: Σ(L x Ψ) calculated using Appendix K						15.03	
Total fabric heat loss					(33) + (36) =	105.17	

	Jan	Feb	Mar	Apr	May	Jun	Jul	Aug	Sep	Oct	Nov	Dec
Ventilation heat loss calculated monthly 0.33 x (25)m x (5)	75.06	74.49	73.93	71.31	70.82	68.53	68.53	68.11	69.41	70.82	71.81	72.85

(38)

	Jan	Feb	Mar	Apr	May	Jun	Jul	Aug	Sep	Oct	Nov	Dec
Heat transfer coefficient, W/K (37)m + (38)m	180.23	179.66	179.10	176.47	175.98	173.70	173.70	173.28	174.58	175.98	176.98	178.01
Average = Σ(39)1...12/12 =	176.47											

(39)

	Jan	Feb	Mar	Apr	May	Jun	Jul	Aug	Sep	Oct	Nov	Dec
Heat loss parameter (HLP), W/m ² K (39)m ÷ (4)	1.23	1.22	1.22	1.20	1.20	1.18	1.18	1.18	1.19	1.20	1.20	1.21
Average = Σ(40)1...12/12 =	1.20											

(40)

	Jan	Feb	Mar	Apr	May	Jun	Jul	Aug	Sep	Oct	Nov	Dec
Number of days in month (Table 1a)	31.00	28.00	31.00	30.00	31.00	30.00	31.00	31.00	30.00	31.00	30.00	31.00

(40)

4. Water heating energy requirement

Assumed occupancy, N	2.93
Annual average hot water usage in litres per day Vd,average = (25 x N) + 36	103.78
	Jan Feb Mar Apr May Jun Jul Aug Sep Oct Nov Dec
Hot water usage in litres per day for each month Vd,m = factor from Table 1c x (43)	114.15 110.00 105.85 101.70 97.55 93.40 93.40 97.55 101.70 105.85 110.00 114.15
Σ(44)1...12 =	1245.30

(44)

	Jan	Feb	Mar	Apr	May	Jun	Jul	Aug	Sep	Oct	Nov	Dec
Energy content of hot water used = 4.18 x Vd,m x nm x Tm/3600 kWh/month (see Tables 1b, 1c 1d)	169.29	148.06	152.78	133.20	127.81	110.29	102.20	117.27	118.67	138.30	150.97	163.94
Σ(45)1...12 =	1632.79											

(45)

	Jan	Feb	Mar	Apr	May	Jun	Jul	Aug	Sep	Oct	Nov	Dec
Distribution loss 0.15 x (45)m	25.39	22.21	22.92	19.98	19.17	16.54	15.33	17.59	17.80	20.75	22.65	24.59

(46)

Storage volume (litres) including any solar or WWHRs storage within same vessel	250.00
---	--------

(47)

Water storage loss:	
a) If manufacturer's declared loss factor is known (kWh/day)	1.67
Temperature factor from Table 2b	0.54
Energy lost from water storage (kWh/day) (48) x (49)	0.90
Enter (50) or (54) in (55)	0.90

(48)

(49)

(50)

(55)

	Jan	Feb	Mar	Apr	May	Jun	Jul	Aug	Sep	Oct	Nov	Dec
Water storage loss calculated for each month (55) x (41)m	27.96	25.25	27.96	27.05	27.96	27.05	27.96	27.96	27.05	27.96	27.05	27.96

(56)

If the vessel contains dedicated solar storage or dedicated WWHRs (56)m x [(47) - Vs] ÷ (47), else (56)

27.96	25.25	27.96	27.05	27.96	27.05	27.96	27.96	27.05	27.96	27.05	27.96
-------	-------	-------	-------	-------	-------	-------	-------	-------	-------	-------	-------

(57)

Primary circuit loss for each month from Table 3

23.26	21.01	23.26	22.51	23.26	22.51	23.26	23.26	22.51	23.26	22.51	23.26
-------	-------	-------	-------	-------	-------	-------	-------	-------	-------	-------	-------

(59)

Combi loss for each month from Table 3a, 3b or 3c

0.00	0.00	0.00	0.00	0.00	0.00	0.00	0.00	0.00	0.00	0.00	0.00
------	------	------	------	------	------	------	------	------	------	------	------

(61)

Total heat required for water heating calculated for each month 0.85 x (45)m + (46)m + (57)m + (61)m

220.50	194.32	204.00	182.77	179.03	159.85	153.42	168.49	168.24	189.52	200.54	215.16
--------	--------	--------	--------	--------	--------	--------	--------	--------	--------	--------	--------

(62)

Solar DHW input calculated using Appendix G or Appendix H

-61.01	-53.69	-54.79	-45.07	-41.84	-34.51	-29.20	-35.35	-36.39	-44.99	-52.13	-58.98
--------	--------	--------	--------	--------	--------	--------	--------	--------	--------	--------	--------

(63)

Output from water heater for each month (kWh/month) (62)m + (63)m

159.49	140.63	149.21	137.70	137.19	125.35	124.22	133.14	131.85	144.53	148.40	156.19
--------	--------	--------	--------	--------	--------	--------	--------	--------	--------	--------	--------

(64)

Heat gains from water heating (kWh/month) 0.25 x [0.85 x (45)m + (61)m] + 0.8 x [(46)m + (57)m + (59)m]

97.26	86.24	91.77	83.94	83.47	76.32	74.96	79.97	79.11	86.96	89.85	95.49
-------	-------	-------	-------	-------	-------	-------	-------	-------	-------	-------	-------

(65)

5. Internal gains

	Jan	Feb	Mar	Apr	May	Jun	Jul	Aug	Sep	Oct	Nov	Dec
Metabolic gains (Table 5)	146.47	146.47	146.47	146.47	146.47	146.47	146.47	146.47	146.47	146.47	146.47	146.47
Lighting gains (calculated in Appendix L, equation L9 or L9a), also see Table 5	28.56	25.36	20.63	15.62	11.67	9.86	10.65	13.84	18.58	23.59	27.53	29.35
Appliance gains (calculated in Appendix L, equation L13 or L13a), also see Table 5	317.30	320.59	312.29	294.63	272.33	251.37	237.37	234.08	242.38	260.04	282.34	303.30
Cooking gains (calculated in Appendix L, equation L15 or L15a), also see Table 5	37.65	37.65	37.65	37.65	37.65	37.65	37.65	37.65	37.65	37.65	37.65	37.65
Pump and fan gains (Table 5a)	3.00	3.00	3.00	3.00	3.00	3.00	3.00	3.00	3.00	3.00	3.00	3.00
Losses e.g. evaporation (Table 5)	-117.18	-117.18	-117.18	-117.18	-117.18	-117.18	-117.18	-117.18	-117.18	-117.18	-117.18	-117.18
Water heating gains (Table 5)	130.73	128.33	123.35	116.59	112.19	106.01	100.75	107.48	109.88	116.88	124.79	128.34
Total internal gains (66)m + (67)m + (68)m + (69)m + (70)m + (71)m + (72)m	546.52	544.23	526.21	496.77	466.14	437.18	418.71	425.35	440.78	470.46	504.61	530.93

(66)

(67)

(68)

(69)

(70)

(71)

(72)

(73)

6. Solar gains

	Access factor Table 6d	Area m ²	Solar flux W/m ²	g specific data or Table 6b	FF specific data or Table 6c	Gains W						
North	0.77	28.76	10.63	0.63	0.70	93.46						
Solar gains in watts Σ(74)m...(82)m	93.46	178.61	303.50	487.50	656.71	703.03	656.36	520.74	364.91	212.61	115.30	77.91
Total gains - internal and solar (73)m + (83)m	639.98	722.83	829.71	984.27	1122.85	1140.20	1075.08	946.09	805.68	683.07	619.90	608.84

(74)

(83)

(84)

7. Mean internal temperature (heating season)

Temperature during heating periods in the living area from Table 9, Th1(°C)	21.00
	Jan Feb Mar Apr May Jun Jul Aug Sep Oct Nov Dec
Utilisation factor for gains for living area n1,m (see Table 9a)	

(85)

1.00	1.00	0.99	0.97	0.92	0.79	0.65	0.73	0.92	0.99	1.00	1.00	(86)
Mean internal temp of living area T1 (steps 3 to 7 in Table 9c)												
19.17	19.32	19.63	20.09	20.53	20.84	20.95	20.91	20.64	20.10	19.57	19.15	(87)
Temperature during heating periods in the rest of dwelling from Table 9, Th2(°C)												
19.90	19.90	19.91	19.92	19.92	19.94	19.94	19.94	19.93	19.92	19.92	19.91	(88)
Utilisation factor for gains for rest of dwelling n2,m												
1.00	1.00	0.99	0.97	0.89	0.71	0.52	0.60	0.88	0.98	1.00	1.00	(89)
Mean internal temperature in the rest of dwelling T2 (follow steps 3 to 7 in Table 9c)												
17.44	17.67	18.12	18.79	19.41	19.80	19.91	19.89	19.58	18.82	18.04	17.43	(90)
Living area fraction Living area ÷ (4) = 0.12 (91)												
Mean internal temperature for the whole dwelling fLA x T1 +(1 - fLA) x T2												
17.64	17.86	18.29	18.94	19.54	19.92	20.03	20.01	19.70	18.97	18.22	17.63	(92)
Apply adjustment to the mean internal temperature from Table 4e where appropriate												
17.49	17.71	18.14	18.79	19.39	19.77	19.88	19.86	19.55	18.82	18.07	17.48	(93)

8. Space heating requirement

	Jan	Feb	Mar	Apr	May	Jun	Jul	Aug	Sep	Oct	Nov	Dec	
Utilisation factor for gains, ηm													
	1.00	0.99	0.98	0.95	0.87	0.70	0.51	0.59	0.86	0.97	0.99	1.00	(94)
Useful gains, ηmGm, W (94)m x (84)m													
	637.13	717.37	815.89	936.75	971.38	792.74	547.59	559.96	692.74	664.07	615.18	606.63	(95)
Monthly average external temperature from Table U1													
	4.30	4.90	6.50	8.90	11.70	14.60	16.60	16.40	14.10	10.60	7.10	4.20	(96)
Heat loss rate for mean internal temperature, Lm, W [(39)m x ((93)m - (96)m)]													
	2378.08	2301.56	2085.35	1745.52	1353.05	898.41	569.71	599.32	952.00	1446.43	1941.52	2364.09	(97)
Space heating requirement, kWh/month 0.024 x ((97)m - (95)m) x (41)m													
	1295.27	1064.58	944.48	582.31	283.97	0.00	0.00	0.00	0.00	582.08	954.96	1307.55	
	Σ(98)1...5, 10...12 =											7015.19 (98)	
Space heating requirement kWh/m ² /year (98) ÷ (4) =													47.71 (99)

9a. Energy requirements - individual heating systems including micro-CHP

Space heating

Fraction of space heat from secondary/supplementary system (table 11)		0.00	(201)										
Fraction of space heat from main system(s)	1 - (201) =	1.00	(202)										
Fraction of space heat from main system 2		0.00	(202)										
Fraction of total space heat from main system 1	(202) x [1 - (203)] =	1.00	(204)										
Fraction of total space heat from main system 2	(202) x (203) =	0.00	(205)										
Efficiency of main system 1 (%)		93.00	(206)										
Space heating fuel (main system 1), kWh/month													
	Jan	Feb	Mar	Apr	May	Jun	Jul	Aug	Sep	Oct	Nov	Dec	
	1392.76	1144.71	1015.57	626.14	305.34	0.00	0.00	0.00	0.00	625.89	1026.84	1405.97	
	Σ(211)1...5, 10...12 =											7543.22 (211)	

Water heating

Efficiency of water heater													
	88.69	88.60	88.37	87.74	86.21	79.30	79.30	79.30	79.30	87.65	88.40	88.72	(217)
Water heating fuel, kWh/month													
	179.83	158.72	168.84	156.95	159.13	158.07	156.65	167.89	166.27	164.90	167.88	176.04	
	Σ(219a)1...12 =											1981.17 (219)	

Annual totals

Space heating fuel - main system 1		7543.22	
Water heating fuel		1981.17	
Electricity for pumps, fans and electric keep-hot (Table 4f)			
central heating pump or water pump within warm air heating unit		30.00	(230c)
boiler flue fan		45.00	(230e)
Total electricity for the above, kWh/year		75.00	(231)
Electricity for lighting (Appendix L)		504.33	(232)
Total delivered energy for all uses	(211)...(221) + (231) + (232)...(237b) =	10103.71	(238)

10a. Fuel costs - individual heating systems including micro-CHP

	Fuel kWh/year		Fuel price		Fuel cost £/year	
Space heating - main system 1	7543.22	x	3.48	x 0.01 =	262.50	(240)
Water heating	1981.17	x	3.48	x 0.01 =	68.94	(247)
Pumps and fans	75.00	x	13.19	x 0.01 =	9.89	(249)
Electricity for lighting	504.33	x	13.19	x 0.01 =	66.52	(250)
Additional standing charges					120.00	(251)
Total energy cost				(240)...(242) + (245)...(254) =	527.86	(255)

11a. SAP rating - individual heating systems including micro-CHP

Energy cost deflator (Table 12)		0.42	(256)
Energy cost factor (ECF)		1.15	(257)
SAP value		83.90	
SAP rating (section 13)		84	(258)
SAP band		B	

12a. CO₂ emissions - individual heating systems including micro-CHP

	Energy kWh/year		Emission factor kg CO ₂ /kWh		Emissions kg CO ₂ /year	
Space heating - main system 1	7543.22	x	0.216	=	1629.33	(261)
Water heating	1981.17	x	0.216	=	427.93	(264)
Space and water heating				(261) + (262) + (263) + (264) =	2057.27	(265)
Pumps and fans	75.00	x	0.519	=	38.93	(267)
Electricity for lighting	504.33	x	0.519	=	261.75	(268)
Total CO ₂ , kg/year				(265)...(271) =	2357.94	(272)
Dwelling CO ₂ emission rate				(272) ÷ (4) =	16.03	(273)
EI value					83.55	
EI rating (section 14)					84	(274)
EI band					B	

13a. Primary energy - individual heating systems including micro-CHP

	Energy kWh/year		Primary factor		Primary Energy kWh/year	
Space heating - main system 1	7543.22	x	1.22	=	9202.72	(261)
Water heating	1981.17	x	1.22	=	2417.02	(264)
Space and water heating				(261) + (262) + (263) + (264) =	11619.75	(265)
Pumps and fans	75.00	x	3.07	=	230.25	(267)
Electricity for lighting	504.33	x	3.07	=	1548.30	(268)
Primary energy kWh/year					13398.29	(272)

DER Worksheet Design - Draft



This design submission has been carried out using Approved SAP software. It has been prepared from plans and specifications and may not reflect the property as constructed.

Assessor name	Mr Simon Gowing	Assessor number	9641
Client		Last modified	29/10/2018
Address	SOMERTON Oxford Road, Bodicaote, OX15		

1. Overall dwelling dimensions

	Area (m ²)	Average storey height (m)	Volume (m ³)
Lowest occupied	71.68 (1a) x	2.36 (2a) =	169.16 (3a)
+1	67.23 (1b) x	2.61 (2b) =	175.47 (3b)
Total floor area	(1a) + (1b) + (1c) + (1d)...(1n) =		138.91 (4)
Dwelling volume	(3a) + (3b) + (3c) + (3d)...(3n) =		344.64 (5)

2. Ventilation rate

Number of chimneys	0	x 40 =	0 (6a)									
Number of open flues	0	x 20 =	0 (6b)									
Number of intermittent fans	4	x 10 =	40 (7a)									
Number of passive vents	0	x 10 =	0 (7b)									
Number of flueless gas fires	0	x 40 =	0 (7c)									
			m³ per hour									
Infiltration due to chimneys, flues, fans, PSVs (6a) + (6b) + (7a) + (7b) + (7c) =			40 ÷ (5) = 0.12 (8)									
<i>If a pressurisation test has been carried out or is intended, proceed to (17), otherwise continue from (9) to (16)</i>												
Air permeability value, q50, expressed in cubic metres per hour per square metre of envelope area			5.00 (17)									
If based on air permeability value, then (18) = [(17) ÷ 20] + (8), otherwise (18) = (16)			0.37 (18)									
Number of sides on which the dwelling is sheltered			1 (19)									
Shelter factor			1 - [0.075 x (19)] = 0.93 (20)									
Infiltration rate incorporating shelter factor			(18) x (20) = 0.34 (21)									
Infiltration rate modified for monthly wind speed:												
	Jan	Feb	Mar	Apr	May	Jun	Jul	Aug	Sep	Oct	Nov	Dec
Monthly average wind speed from Table U2	5.10	5.00	4.90	4.40	4.30	3.80	3.80	3.70	4.00	4.30	4.50	4.70
Wind factor (22)m ÷ 4	1.28	1.25	1.23	1.10	1.08	0.95	0.95	0.93	1.00	1.08	1.13	1.18
Adjusted infiltration rate (allowing for shelter and wind factor) (21) x (22a)m	0.43	0.42	0.41	0.37	0.36	0.32	0.32	0.31	0.34	0.36	0.38	0.40
Calculate effective air change rate for the applicable case:												
If mechanical ventilation: air change rate through system	N/A (23a)											
If balanced with heat recovery: efficiency in % allowing for in-use factor from Table 4h	N/A (23c)											
d) natural ventilation or whole house positive input ventilation from loft	0.59	0.59	0.59	0.57	0.57	0.55	0.55	0.55	0.56	0.57	0.57	0.58
Effective air change rate - enter (24a) or (24b) or (24c) or (24d) in (25)												

DRAFT



0.59	0.59	0.59	0.57	0.57	0.55	0.55	0.55	0.56	0.57	0.57	0.58
------	------	------	------	------	------	------	------	------	------	------	------

(25)

3. Heat losses and heat loss parameter

Element	Gross area, m ²	Openings m ²	Net area A, m ²	U-value W/m ² K	A x U W/K	κ-value, kJ/m ² .K	A x κ, kJ/K
Window			35.31	1.24	43.63		
Door			2.03	1.30	2.64		
Ground floor			71.68	0.15	10.75		
External wall			138.62	0.21	29.11		
Roof			67.23	0.11	7.40		
Roof			4.41	0.21	0.93		
Total area of external elements ΣA, m ²			319.28				
Fabric heat loss, W/K = Σ(A x U)					(26)...(30) + (32) =	94.46	
Heat capacity Cm = Σ(A x κ)					(28)...(30) + (32) + (32a)...(32e) =	N/A	
Thermal mass parameter (TMP) in kJ/m ² K						191.00	
Thermal bridges: Σ(L x Ψ) calculated using Appendix K						18.18	
Total fabric heat loss					(33) + (36) =	112.64	

	Jan	Feb	Mar	Apr	May	Jun	Jul	Aug	Sep	Oct	Nov	Dec
Ventilation heat loss calculated monthly 0.33 x (25)m x (5)	67.46	67.05	66.65	64.75	64.40	62.75	62.75	62.44	63.38	64.40	65.12	65.87

(38)

	Jan	Feb	Mar	Apr	May	Jun	Jul	Aug	Sep	Oct	Nov	Dec
Heat transfer coefficient, W/K (37)m + (38)m	180.10	179.69	179.29	177.39	177.04	175.39	175.39	175.08	176.02	177.04	177.75	178.50
Average = Σ(39)1...12/12 =	177.39											

(39)

	Jan	Feb	Mar	Apr	May	Jun	Jul	Aug	Sep	Oct	Nov	Dec
Heat loss parameter (HLP), W/m ² K (39)m ÷ (4)	1.30	1.29	1.29	1.28	1.27	1.26	1.26	1.26	1.27	1.27	1.28	1.29
Average = Σ(40)1...12/12 =	1.28											

(40)

	Jan	Feb	Mar	Apr	May	Jun	Jul	Aug	Sep	Oct	Nov	Dec
Number of days in month (Table 1a)	31.00	28.00	31.00	30.00	31.00	30.00	31.00	31.00	30.00	31.00	30.00	31.00

(40)

4. Water heating energy requirement

Assumed occupancy, N	2.91											
Annual average hot water usage in litres per day Vd,average = (25 x N) + 36	103.43											
	Jan	Feb	Mar	Apr	May	Jun	Jul	Aug	Sep	Oct	Nov	Dec
Hot water usage in litres per day for each month Vd,m = factor from Table 1c x (43)	113.77	109.64	105.50	101.36	97.22	93.09	93.09	97.22	101.36	105.50	109.64	113.77
Σ(44)1...12 =	1241.17											

(44)

	Jan	Feb	Mar	Apr	May	Jun	Jul	Aug	Sep	Oct	Nov	Dec
Energy content of hot water used = 4.18 x Vd,m x nm x Tm/3600 kWh/month (see Tables 1b, 1c 1d)	168.72	147.57	152.28	132.76	127.38	109.92	101.86	116.89	118.28	137.85	150.47	163.40
Σ(45)1...12 =	1627.37											

(45)

	Jan	Feb	Mar	Apr	May	Jun	Jul	Aug	Sep	Oct	Nov	Dec
Distribution loss 0.15 x (45)m	25.31	22.13	22.84	19.91	19.11	16.49	15.28	17.53	17.74	20.68	22.57	24.51

(46)

Storage volume (litres) including any solar or WWHRs storage within same vessel	250.00
---	--------

(47)

Water storage loss:	
a) If manufacturer's declared loss factor is known (kWh/day)	1.67
Temperature factor from Table 2b	0.54
Energy lost from water storage (kWh/day) (48) x (49)	0.90
Enter (50) or (54) in (55)	0.90

(48)

(49)

(50)

(55)

	Jan	Feb	Mar	Apr	May	Jun	Jul	Aug	Sep	Oct	Nov	Dec
Water storage loss calculated for each month (55) x (41)m	27.96	25.25	27.96	27.05	27.96	27.05	27.96	27.96	27.05	27.96	27.05	27.96

(56)

If the vessel contains dedicated solar storage or dedicated WWHRs (56)m x [(47) - Vs] ÷ (47), else (56)

27.96	25.25	27.96	27.05	27.96	27.05	27.96	27.96	27.05	27.96	27.05	27.96
-------	-------	-------	-------	-------	-------	-------	-------	-------	-------	-------	-------

(57)

Primary circuit loss for each month from Table 3

23.26	21.01	23.26	22.51	23.26	22.51	23.26	23.26	22.51	23.26	22.51	23.26
-------	-------	-------	-------	-------	-------	-------	-------	-------	-------	-------	-------

(59)

Combi loss for each month from Table 3a, 3b or 3c

0.00	0.00	0.00	0.00	0.00	0.00	0.00	0.00	0.00	0.00	0.00	0.00
------	------	------	------	------	------	------	------	------	------	------	------

(61)

Total heat required for water heating calculated for each month 0.85 x (45)m + (46)m + (57)m + (59)m

219.94	193.83	203.49	182.32	178.60	159.49	153.08	168.10	167.85	189.06	200.04	214.62
--------	--------	--------	--------	--------	--------	--------	--------	--------	--------	--------	--------

(62)

Solar DHW input calculated using Appendix G or Appendix H

-59.70	-52.53	-53.62	-44.10	-40.94	-33.77	-28.57	-34.60	-35.61	-44.03	-51.01	-57.71
--------	--------	--------	--------	--------	--------	--------	--------	--------	--------	--------	--------

(63)

Output from water heater for each month (kWh/month) (62)m + (63)m

160.24	141.30	149.88	138.22	137.66	125.72	124.51	133.51	132.24	145.03	149.02	156.91
--------	--------	--------	--------	--------	--------	--------	--------	--------	--------	--------	--------

(64)

Heat gains from water heating (kWh/month) 0.25 x [0.85 x (45)m + (61)m] + 0.8 x [(46)m + (57)m + (59)m]

97.08	86.08	91.61	83.79	83.33	76.20	74.84	79.84	78.98	86.81	89.68	95.30
-------	-------	-------	-------	-------	-------	-------	-------	-------	-------	-------	-------

(65)

5. Internal gains

	Jan	Feb	Mar	Apr	May	Jun	Jul	Aug	Sep	Oct	Nov	Dec
Metabolic gains (Table 5)	145.75	145.75	145.75	145.75	145.75	145.75	145.75	145.75	145.75	145.75	145.75	145.75
Lighting gains (calculated in Appendix L, equation L9 or L9a), also see Table 5	27.47	24.40	19.84	15.02	11.23	9.48	10.24	13.32	17.87	22.69	26.49	28.24
Appliance gains (calculated in Appendix L, equation L13 or L13a), also see Table 5	308.17	311.37	303.31	286.15	264.50	244.14	230.55	227.35	235.41	252.56	274.22	294.57
Cooking gains (calculated in Appendix L, equation L15 or L15a), also see Table 5	37.57	37.57	37.57	37.57	37.57	37.57	37.57	37.57	37.57	37.57	37.57	37.57
Pump and fan gains (Table 5a)	3.00	3.00	3.00	3.00	3.00	3.00	3.00	3.00	3.00	3.00	3.00	3.00
Losses e.g. evaporation (Table 5)	-116.60	-116.60	-116.60	-116.60	-116.60	-116.60	-116.60	-116.60	-116.60	-116.60	-116.60	-116.60
Water heating gains (Table 5)	130.48	128.09	123.13	116.38	112.00	105.84	100.60	107.31	109.70	116.68	124.56	128.10
Total internal gains (66)m + (67)m + (68)m + (69)m + (70)m + (71)m + (72)m	535.84	533.58	516.00	487.28	457.46	429.19	411.11	417.70	432.70	461.66	494.99	520.63

(66)

(67)

(68)

(69)

(70)

(71)

(72)

(73)

6. Solar gains

	Access factor Table 6d	Area m ²	Solar flux W/m ²	g specific data or Table 6b	FF specific data or Table 6c	Gains W						
South	0.77	10.22	46.75	0.63	0.70	146.02						
North	0.77	11.63	10.63	0.63	0.70	37.79						
East	0.77	7.18	19.64	0.63	0.70	43.10						
West	0.77	6.28	19.64	0.63	0.70	37.69						
Solar gains in watts Σ(74)m...(82)m	264.61	469.42	687.64	921.04	1089.56	1105.80	1056.17	927.66	768.50	531.45	320.45	224.12
Total gains - internal and solar (73)m + (83)m	800.45	1003.00	1203.65	1408.32	1547.01	1534.99	1467.28	1345.36	1201.20	993.11	815.44	744.76

(78)

(74)

(76)

(80)

(83)

(84)

7. Mean internal temperature (heating season)

Temperature during heating periods in the living area from Table 9, Th1(°C) (85)

Jan	Feb	Mar	Apr	May	Jun	Jul	Aug	Sep	Oct	Nov	Dec
-----	-----	-----	-----	-----	-----	-----	-----	-----	-----	-----	-----

Utilisation factor for gains for living area n1,m (see Table 9a)

0.99	0.99	0.97	0.92	0.81	0.65	0.50	0.56	0.80	0.95	0.99	1.00
------	------	------	------	------	------	------	------	------	------	------	------

Mean internal temp of living area T1 (steps 3 to 7 in Table 9c)

19.22	19.47	19.85	20.31	20.69	20.90	20.97	20.96	20.79	20.28	19.66	19.18
-------	-------	-------	-------	-------	-------	-------	-------	-------	-------	-------	-------

Temperature during heating periods in the rest of dwelling from Table 9, Th2(°C)

19.84	19.85	19.85	19.86	19.86	19.87	19.87	19.87	19.87	19.86	19.86	19.85
-------	-------	-------	-------	-------	-------	-------	-------	-------	-------	-------	-------

Utilisation factor for gains for rest of dwelling n2,m

0.99	0.98	0.96	0.90	0.76	0.56	0.38	0.44	0.72	0.93	0.99	0.99
------	------	------	------	------	------	------	------	------	------	------	------

Mean internal temperature in the rest of dwelling T2 (follow steps 3 to 7 in Table 9c)

17.48	17.84	18.39	19.05	19.55	19.80	19.86	19.85	19.69	19.02	18.13	17.43
-------	-------	-------	-------	-------	-------	-------	-------	-------	-------	-------	-------

Living area fraction Living area ÷ (4) = (91)

Mean internal temperature for the whole dwelling fLA x T1 +(1 - fLA) x T2

17.80	18.14	18.66	19.28	19.76	20.01	20.07	20.06	19.89	19.25	18.41	17.75
-------	-------	-------	-------	-------	-------	-------	-------	-------	-------	-------	-------

Apply adjustment to the mean internal temperature from Table 4e where appropriate

17.65	17.99	18.51	19.13	19.61	19.86	19.92	19.91	19.74	19.10	18.26	17.60
-------	-------	-------	-------	-------	-------	-------	-------	-------	-------	-------	-------

8. Space heating requirement

Jan	Feb	Mar	Apr	May	Jun	Jul	Aug	Sep	Oct	Nov	Dec
-----	-----	-----	-----	-----	-----	-----	-----	-----	-----	-----	-----

Utilisation factor for gains, ηm

0.99	0.98	0.95	0.88	0.75	0.56	0.39	0.44	0.71	0.92	0.98	0.99
------	------	------	------	------	------	------	------	------	------	------	------

Useful gains, ηmGm, W (94)m x (84)m

791.57	978.74	1139.26	1235.65	1159.43	863.72	570.89	596.84	853.35	911.61	798.28	738.30
--------	--------	---------	---------	---------	--------	--------	--------	--------	--------	--------	--------

Monthly average external temperature from Table U1

4.30	4.90	6.50	8.90	11.70	14.60	16.60	16.40	14.10	10.60	7.10	4.20
------	------	------	------	-------	-------	-------	-------	-------	-------	------	------

Heat loss rate for mean internal temperature, Lm, W [(39)m x [(93)m - (96)m]

2404.98	2352.81	2152.92	1815.56	1400.12	921.70	581.42	614.10	993.27	1505.10	1983.63	2392.21
---------	---------	---------	---------	---------	--------	--------	--------	--------	---------	---------	---------

Space heating requirement, kWh/month 0.024 x [(97)m - (95)m] x (41)m

1200.38	923.38	754.16	417.54	179.07	0.00	0.00	0.00	0.00	441.55	853.45	1230.51
---------	--------	--------	--------	--------	------	------	------	------	--------	--------	---------

$\Sigma(98)1...5, 10...12 =$ (98)

Space heating requirement kWh/m²/year (98) ÷ (4) = (99)

9a. Energy requirements - individual heating systems including micro-CHP

Space heating

Fraction of space heat from secondary/supplementary system (table 11) (201)

Fraction of space heat from main system(s) 1 - (201) = (202)

Fraction of space heat from main system 2 (202)

Fraction of total space heat from main system 1 (202) x [1 - (203)] = (204)

Fraction of total space heat from main system 2 (202) x (203) = (205)

Efficiency of main system 1 (%) (206)

Jan	Feb	Mar	Apr	May	Jun	Jul	Aug	Sep	Oct	Nov	Dec
-----	-----	-----	-----	-----	-----	-----	-----	-----	-----	-----	-----

Space heating fuel (main system 1), kWh/month

1290.73	992.88	810.93	448.96	192.55	0.00	0.00	0.00	0.00	474.79	917.69	1323.13
---------	--------	--------	--------	--------	------	------	------	------	--------	--------	---------

$\Sigma(211)1...5, 10...12 =$ (211)

Water heating

Efficiency of water heater

88.59	88.42	88.03	87.08	85.01	79.30	79.30	79.30	79.30	87.09	88.23	88.65
-------	-------	-------	-------	-------	-------	-------	-------	-------	-------	-------	-------

Water heating fuel, kWh/month

180.87	159.81	170.26	158.74	161.93	158.54	157.01	168.36	166.76	166.53	168.90	177.00
--------	--------	--------	--------	--------	--------	--------	--------	--------	--------	--------	--------

$\Sigma(219a)1...12 =$ (219)

Annual totals

Space heating fuel - main system 1

Water heating fuel

Electricity for pumps, fans and electric keep-hot (Table 4f)

central heating pump or water pump within warm air heating unit (230c)

boiler flue fan (230e)

Total electricity for the above, kWh/year (231)

Electricity for lighting (Appendix L) (232)

Total delivered energy for all uses (211)...(221) + (231) + (232)...(237b) = (238)

10a. Fuel costs - individual heating systems including micro-CHP

	Fuel kWh/year		Fuel price		Fuel cost £/year
Space heating - main system 1	<input type="text" value="6451.66"/>	x	<input type="text" value="3.48"/>	x 0.01 =	<input type="text" value="224.52"/> (240)
Water heating	<input type="text" value="1994.69"/>	x	<input type="text" value="3.48"/>	x 0.01 =	<input type="text" value="69.42"/> (247)
Pumps and fans	<input type="text" value="75.00"/>	x	<input type="text" value="13.19"/>	x 0.01 =	<input type="text" value="9.89"/> (249)
Electricity for lighting	<input type="text" value="485.19"/>	x	<input type="text" value="13.19"/>	x 0.01 =	<input type="text" value="64.00"/> (250)
Additional standing charges					<input type="text" value="120.00"/> (251)
Total energy cost				(240)...(242) + (245)...(254) =	<input type="text" value="487.82"/> (255)

11a. SAP rating - individual heating systems including micro-CHP

Energy cost deflator (Table 12)	<input type="text" value="0.42"/> (256)
Energy cost factor (ECF)	<input type="text" value="1.11"/> (257)
SAP value	<input type="text" value="84.46"/>
SAP rating (section 13)	<input type="text" value="84"/> (258)
SAP band	<input type="text" value="B"/>

12a. CO₂ emissions - individual heating systems including micro-CHP

	Energy kWh/year		Emission factor kg CO ₂ /kWh		Emissions kg CO ₂ /year
Space heating - main system 1	<input type="text" value="6451.66"/>	x	<input type="text" value="0.216"/>	=	<input type="text" value="1393.56"/> (261)
Water heating	<input type="text" value="1994.69"/>	x	<input type="text" value="0.216"/>	=	<input type="text" value="430.85"/> (264)
Space and water heating				(261) + (262) + (263) + (264) =	<input type="text" value="1824.41"/> (265)
Pumps and fans	<input type="text" value="75.00"/>	x	<input type="text" value="0.519"/>	=	<input type="text" value="38.93"/> (267)
Electricity for lighting	<input type="text" value="485.19"/>	x	<input type="text" value="0.519"/>	=	<input type="text" value="251.81"/> (268)
Total CO ₂ , kg/year				(265)...(271) =	<input type="text" value="2115.15"/> (272)
Dwelling CO ₂ emission rate				(272) ÷ (4) =	<input type="text" value="528.79"/> (273)
EI value					<input type="text" value="84.59"/>
EI rating (section 14)					<input type="text" value="85"/> (274)
EI band					<input type="text" value="B"/>

13a. Primary energy - individual heating systems including micro-CHP

	Energy kWh/year		Primary factor		Primary Energy kWh/year
Space heating - main system 1	<input type="text" value="6451.66"/>	x	<input type="text" value="1.22"/>	=	<input type="text" value="7871.02"/> (261)
Water heating	<input type="text" value="1994.69"/>	x	<input type="text" value="1.22"/>	=	<input type="text" value="2433.53"/> (264)
Space and water heating				(261) + (262) + (263) + (264) =	<input type="text" value="10304.55"/> (265)

Pumps and fans	<input type="text" value="75.00"/>	x	<input type="text" value="3.07"/>	=	<input type="text" value="230.25"/>	(267)
Electricity for lighting	<input type="text" value="485.19"/>	x	<input type="text" value="3.07"/>	=	<input type="text" value="1489.54"/>	(268)
Primary energy kWh/year					<input type="text" value="12024.34"/>	(272)
Dwelling primary energy rate kWh/m ² /year					<input type="text" value="86.56"/>	(273)

DER Worksheet Design - Draft



This design submission has been carried out using Approved SAP software. It has been prepared from plans and specifications and may not reflect the property as constructed.

Assessor name	Mr Simon Gowing	Assessor number	9641
Client		Last modified	29/10/2018
Address	TF 1B Oxford Road, Bodicaote, OX15		

1. Overall dwelling dimensions

	Area (m ²)	Average storey height (m)	Volume (m ³)
Lowest occupied	<input type="text" value="4.51"/> (1a) x	<input type="text" value="2.83"/> (2a) =	<input type="text" value="12.76"/> (3a)
+1	<input type="text" value="50.48"/> (1b) x	<input type="text" value="2.39"/> (2b) =	<input type="text" value="120.65"/> (3b)
Total floor area	(1a) + (1b) + (1c) + (1d)...(1n) =		<input type="text" value="54.99"/> (4)
Dwelling volume	(3a) + (3b) + (3c) + (3d)...(3n) =		<input type="text" value="133.41"/> (5)

2. Ventilation rate

	m ³ per hour
Number of chimneys	<input type="text" value="0"/> x 40 = <input type="text" value="0"/> (6a)
Number of open flues	<input type="text" value="0"/> x 20 = <input type="text" value="0"/> (6b)
Number of intermittent fans	<input type="text" value="0"/> x 10 = <input type="text" value="0"/> (7a)
Number of passive vents	<input type="text" value="0"/> x 10 = <input type="text" value="0"/> (7b)
Number of flueless gas fires	<input type="text" value="0"/> x 40 = <input type="text" value="0"/> (7c)

Air changes per hour
 Infiltration due to chimneys, flues, fans, PSVs (6a) + (6b) + (7a) + (7b) + (7c) = ÷ (5) = (8)

If a pressurisation test has been carried out or is intended, proceed to (17), otherwise continue from (9) to (16)

Air permeability value, q ₅₀ , expressed in cubic metres per hour per square metre of envelope area	<input type="text" value="4.00"/> (17)
If based on air permeability value, then (18) = [(17) ÷ 20] + (8), otherwise (18) = (16)	<input type="text" value="0.20"/> (18)
Number of sides on which the dwelling is sheltered	<input type="text" value="1"/> (19)
Shelter factor	1 - [0.075 x (19)] = <input type="text" value="0.93"/> (20)
Infiltration rate incorporating shelter factor	(18) x (20) = <input type="text" value="0.19"/> (21)

Infiltration rate modified for monthly wind speed:

	Jan	Feb	Mar	Apr	May	Jun	Jul	Aug	Sep	Oct	Nov	Dec
Monthly average wind speed from Table U2	<input type="text" value="5.10"/>	<input type="text" value="5.00"/>	<input type="text" value="4.90"/>	<input type="text" value="4.40"/>	<input type="text" value="4.30"/>	<input type="text" value="3.80"/>	<input type="text" value="3.80"/>	<input type="text" value="3.70"/>	<input type="text" value="4.00"/>	<input type="text" value="4.30"/>	<input type="text" value="4.50"/>	<input type="text" value="4.70"/>

Wind factor (22)m ÷ 4	<input type="text" value="1.28"/>	<input type="text" value="1.25"/>	<input type="text" value="1.23"/>	<input type="text" value="1.10"/>	<input type="text" value="1.08"/>	<input type="text" value="0.95"/>	<input type="text" value="0.95"/>	<input type="text" value="0.93"/>	<input type="text" value="1.00"/>	<input type="text" value="1.08"/>	<input type="text" value="1.13"/>	<input type="text" value="1.18"/>
-----------------------	-----------------------------------	-----------------------------------	-----------------------------------	-----------------------------------	-----------------------------------	-----------------------------------	-----------------------------------	-----------------------------------	-----------------------------------	-----------------------------------	-----------------------------------	-----------------------------------

Adjusted infiltration rate (allowing for shelter and wind factor) (21) x (22a)m	<input type="text" value="0.24"/>	<input type="text" value="0.23"/>	<input type="text" value="0.23"/>	<input type="text" value="0.20"/>	<input type="text" value="0.20"/>	<input type="text" value="0.18"/>	<input type="text" value="0.18"/>	<input type="text" value="0.17"/>	<input type="text" value="0.19"/>	<input type="text" value="0.20"/>	<input type="text" value="0.21"/>	<input type="text" value="0.22"/>
---	-----------------------------------	-----------------------------------	-----------------------------------	-----------------------------------	-----------------------------------	-----------------------------------	-----------------------------------	-----------------------------------	-----------------------------------	-----------------------------------	-----------------------------------	-----------------------------------

Calculate effective air change rate for the applicable case:

If mechanical ventilation: air change rate through system (23a)

If balanced with heat recovery: efficiency in % allowing for in-use factor from Table 4h (23c)

c) whole house extract ventilation or positive input ventilation from outside

<input type="text" value="0.50"/>	<input type="text" value="0.50"/>	<input type="text" value="0.50"/>	<input type="text" value="0.50"/>	<input type="text" value="0.50"/>	<input type="text" value="0.50"/>	<input type="text" value="0.50"/>	<input type="text" value="0.50"/>	<input type="text" value="0.50"/>	<input type="text" value="0.50"/>	<input type="text" value="0.50"/>	<input type="text" value="0.50"/>	<input type="text" value="0.50"/>
-----------------------------------	-----------------------------------	-----------------------------------	-----------------------------------	-----------------------------------	-----------------------------------	-----------------------------------	-----------------------------------	-----------------------------------	-----------------------------------	-----------------------------------	-----------------------------------	-----------------------------------

Effective air change rate - enter (24a) or (24b) or (24c) or (24d) in (25)

DRAFT

0.50	0.50	0.50	0.50	0.50	0.50	0.50	0.50	0.50	0.50	0.50	0.50	0.50	(25)
------	------	------	------	------	------	------	------	------	------	------	------	------	------

3. Heat losses and heat loss parameter

Element	Gross area, m ²	Openings m ²	Net area A, m ²	U-value W/m ² K	A x U W/K	k-value, kJ/m ² .K	A x κ, kJ/K
Window			5.49	1.24	6.78		
Door			2.22	1.30	2.89		
Ground floor			4.51	0.19	0.86		
External wall			53.38	0.20	10.68		
Party wall			41.82	0.00	0.00		
Roof			50.48	0.11	5.55		
Total area of external elements ΣA, m ²			116.08				
Fabric heat loss, W/K = Σ(A x U)					(26)...(30) + (32) =		26.76
Heat capacity Cm = Σ(A x κ)					(28)...(30) + (32) + (32a)...(32e) =		N/A
Thermal mass parameter (TMP) in kJ/m ² K							185.00
Thermal bridges: Σ(L x Ψ) calculated using Appendix K							5.94
Total fabric heat loss					(33) + (36) =		32.69

	Jan	Feb	Mar	Apr	May	Jun	Jul	Aug	Sep	Oct	Nov	Dec
Ventilation heat loss calculated monthly 0.33 x (25)m x (5)	22.01	22.01	22.01	22.01	22.01	22.01	22.01	22.01	22.01	22.01	22.01	22.01

	Jan	Feb	Mar	Apr	May	Jun	Jul	Aug	Sep	Oct	Nov	Dec
Heat transfer coefficient, W/K (37)m + (38)m	54.70	54.70	54.70	54.70	54.70	54.70	54.70	54.70	54.70	54.70	54.70	54.70
Average = Σ(39)1...12/12 =	54.70											

	Jan	Feb	Mar	Apr	May	Jun	Jul	Aug	Sep	Oct	Nov	Dec
Heat loss parameter (HLP), W/m ² K (39)m ÷ (4)	0.99	0.99	0.99	0.99	0.99	0.99	0.99	0.99	0.99	0.99	0.99	0.99
Average = Σ(40)1...12/12 =	0.99											

	Jan	Feb	Mar	Apr	May	Jun	Jul	Aug	Sep	Oct	Nov	Dec
Number of days in month (Table 1a)	31.00	28.00	31.00	30.00	31.00	30.00	31.00	31.00	30.00	31.00	30.00	31.00

4. Water heating energy requirement

Assumed occupancy, N	1.84											
Annual average hot water usage in litres per day Vd,average = (25 x N) + 36	77.83											
	Jan	Feb	Mar	Apr	May	Jun	Jul	Aug	Sep	Oct	Nov	Dec
Hot water usage in litres per day for each month Vd,m = factor from Table 1c x (43)	85.61	82.50	79.39	76.27	73.16	70.05	70.05	73.16	76.27	79.39	82.50	85.61
Σ(44)1...12 =	933.96											

	Jan	Feb	Mar	Apr	May	Jun	Jul	Aug	Sep	Oct	Nov	Dec
Energy content of hot water used = 4.18 x Vd,m x nm x Tm/3600 kWh/month (see Tables 1b, 1c 1d)	126.96	111.04	114.59	99.90	95.85	82.72	76.65	87.95	89.01	103.73	113.23	122.96
Σ(45)1...12 =	1224.57											

	Jan	Feb	Mar	Apr	May	Jun	Jul	Aug	Sep	Oct	Nov	Dec
Distribution loss 0.15 x (45)m	19.04	16.66	17.19	14.98	14.38	12.41	11.50	13.19	13.35	15.56	16.98	18.44

	Jan	Feb	Mar	Apr	May	Jun	Jul	Aug	Sep	Oct	Nov	Dec
Water storage loss calculated for each month (55) x (41)m	0.00	0.00	0.00	0.00	0.00	0.00	0.00	0.00	0.00	0.00	0.00	0.00

	Jan	Feb	Mar	Apr	May	Jun	Jul	Aug	Sep	Oct	Nov	Dec
If the vessel contains dedicated solar storage or dedicated WWHRS (56)m x [(47) - Vs] ÷ (47), else (56)	0.00	0.00	0.00	0.00	0.00	0.00	0.00	0.00	0.00	0.00	0.00	0.00

	Jan	Feb	Mar	Apr	May	Jun	Jul	Aug	Sep	Oct	Nov	Dec
Primary circuit loss for each month from Table 3	0.00	0.00	0.00	0.00	0.00	0.00	0.00	0.00	0.00	0.00	0.00	0.00

	Jan	Feb	Mar	Apr	May	Jun	Jul	Aug	Sep	Oct	Nov	Dec
Combi loss for each month from Table 3a, 3b or 3c	21.63	19.51	21.55	20.80	21.46	20.72	21.39	21.43	20.77	21.51	20.88	21.61

	Jan	Feb	Mar	Apr	May	Jun	Jul	Aug	Sep	Oct	Nov	Dec
Total heat required for water heating calculated for each month 0.85 x (45)m + (46)m + (57)m + (59)m + (61)m	148.59	130.55	136.14	120.70	117.31	103.44	98.03	109.39	109.77	125.24	134.10	144.57

	Jan	Feb	Mar	Apr	May	Jun	Jul	Aug	Sep	Oct	Nov	Dec
Solar DHW input calculated using Appendix G or Appendix H	-38.34	-33.73	-34.43	-28.37	-26.36	-21.77	-18.45	-22.33	-22.97	-28.36	-32.81	-37.05

	Jan	Feb	Mar	Apr	May	Jun	Jul	Aug	Sep	Oct	Nov	Dec
Output from water heater for each month (kWh/month) (62)m + (63)m	110.25	96.82	101.71	92.33	90.95	81.67	79.58	87.06	86.80	96.88	101.30	107.52
Σ(64)1...12 =	1132.88											

	Jan	Feb	Mar	Apr	May	Jun	Jul	Aug	Sep	Oct	Nov	Dec
Heat gains from water heating (kWh/month) 0.25 x [0.85 x (45)m + (61)m] + 0.8 x [(46)m + (57)m + (59)m]	47.62	41.80	43.49	38.42	37.24	32.68	30.83	34.60	34.79	39.87	42.87	46.29

5. Internal gains

	Jan	Feb	Mar	Apr	May	Jun	Jul	Aug	Sep	Oct	Nov	Dec
Metabolic gains (Table 5)	91.85	91.85	91.85	91.85	91.85	91.85	91.85	91.85	91.85	91.85	91.85	91.85

	Jan	Feb	Mar	Apr	May	Jun	Jul	Aug	Sep	Oct	Nov	Dec
Lighting gains (calculated in Appendix L, equation L9 or L9a), also see Table 5	16.49	14.65	11.91	9.02	6.74	5.69	6.15	7.99	10.73	13.62	15.90	16.95

	Jan	Feb	Mar	Apr	May	Jun	Jul	Aug	Sep	Oct	Nov	Dec
Appliance gains (calculated in Appendix L, equation L13 or L13a), also see Table 5	160.16	161.82	157.63	148.72	137.46	126.89	119.82	118.16	122.34	131.26	142.52	153.09

	Jan	Feb	Mar	Apr	May	Jun	Jul	Aug	Sep	Oct	Nov	Dec
Cooking gains (calculated in Appendix L, equation L15 or L15a), also see Table 5	32.19	32.19	32.19	32.19	32.19	32.19	32.19	32.19	32.19	32.19	32.19	32.19

	Jan	Feb	Mar	Apr	May	Jun	Jul	Aug	Sep	Oct	Nov	Dec
Pump and fan gains (Table 5a)	3.00	3.00	3.00	3.00	3.00	3.00	3.00	3.00	3.00	3.00	3.00	3.00

	Jan	Feb	Mar	Apr	May	Jun	Jul	Aug	Sep	Oct	Nov	Dec
Losses e.g. evaporation (Table 5)	-73.48	-73.48	-73.48	-73.48	-73.48	-73.48	-73.48	-73.48	-73.48	-73.48	-73.48	-73.48

	Jan	Feb	Mar	Apr	May	Jun	Jul	Aug	Sep	Oct	Nov	Dec
Water heating gains (Table 5)	64.01	62.20	58.45	53.36	50.05	45.39	41.44	46.51	48.31	53.58	59.54	62.21

	Jan	Feb	Mar	Apr	May	Jun	Jul	Aug	Sep	Oct	Nov	Dec
Total internal gains (66)m + (67)m + (68)m + (69)m + (70)m + (71)m + (72)m	294.22	292.23	281.55	264.65	247.81	231.53	220.97	226.22	234.94	252.03	271.51	285.81

6. Solar gains

	Access factor Table 6d	Area m ²	Solar flux W/m ²	g specific data or Table 6b	FF specific data or Table 6c	Gains W
NorthWest	0.77	1.70	11.28	0.9 x 0.63	0.70	5.86
SouthEast	0.77	3.79	36.79	0.9 x 0.63	0.70	42.62

	Jan	Feb	Mar	Apr	May	Jun	Jul	Aug	Sep	Oct	Nov	Dec
Solar gains in watts Σ(74)m...(82)m	48.48	84.53	120.82	158.37	185.31	187.45	179.27	158.65	133.74	94.81	58.42	41.26

	Jan	Feb	Mar	Apr	May	Jun	Jul	Aug	Sep	Oct	Nov	Dec
Total gains - internal and solar (73)m + (83)m	342.70	376.75	402.38	423.02	433.11	418.97	400.23	384.86	368.69	346.84	329.93	327.07

7. Mean internal temperature (heating season)

	Jan	Feb	Mar	Apr	May	Jun	Jul	Aug	Sep	Oct	Nov	Dec
Temperature during heating periods in the living area from Table 9, Th1(°C)	21.00											

	Jan	Feb	Mar	Apr	May	Jun	Jul	Aug	Sep	Oct	Nov	Dec
Utilisation factor for gains for living area n1,m (see Table 9a)	0.99	0.99	0.98	0.95	0.88	0.74	0.57	0.62	0.83	0.95	0.99	0.99

	Jan	Feb	Mar	Apr	May	Jun	Jul	Aug	Sep	Oct	Nov	Dec
Mean internal temp of living area T1 (steps 3 to 7 in Table 9c)	19.72	19.87	20.11	20.42	20.71	20.91	20.98	20.97	20.84	20.47	20.03	19.68

	Jan	Feb	Mar	Apr	May	Jun	Jul	Aug	Sep	Oct	Nov	Dec
Temperature during heating periods in the rest of dwelling from Table 9, Th2(°C)	20.09	20.09	20.09	20.09	20.09	20.09	20.09	20.09	20.09	20.09	20.09	20.09

Utilisation factor for gains for rest of dwelling n2,m	0.99	0.98	0.97	0.93	0.84	0.66	0.47	0.51	0.77	0.94	0.98	0.99	(89)
--	------	------	------	------	------	------	------	------	------	------	------	------	------

Mean internal temperature in the rest of dwelling T2 (follow steps 3 to 7 in Table 9c)	18.38	18.58	18.93	19.38	19.78	20.01	20.08	20.07	19.94	19.46	18.83	18.31	(90)
--	-------	-------	-------	-------	-------	-------	-------	-------	-------	-------	-------	-------	------

Living area fraction	Living area ÷ (4) =												0.34	(91)
----------------------	---------------------	--	--	--	--	--	--	--	--	--	--	--	------	------

Mean internal temperature for the whole dwelling fLA x T1 + (1 - fLA) x T2	18.84	19.02	19.33	19.73	20.10	20.32	20.38	20.38	20.25	19.80	19.24	18.78	(92)
--	-------	-------	-------	-------	-------	-------	-------	-------	-------	-------	-------	-------	------

Apply adjustment to the mean internal temperature from Table 4e where appropriate	18.69	18.87	19.18	19.58	19.95	20.17	20.23	20.23	20.10	19.65	19.09	18.63	(93)
---	-------	-------	-------	-------	-------	-------	-------	-------	-------	-------	-------	-------	------

8. Space heating requirement

	Jan	Feb	Mar	Apr	May	Jun	Jul	Aug	Sep	Oct	Nov	Dec	
Utilisation factor for gains, ηm	0.99	0.98	0.96	0.92	0.83	0.67	0.49	0.53	0.77	0.93	0.98	0.99	(94)

Useful gains, ηmGm, W (94)m x (84)m	337.83	368.34	386.56	389.44	360.57	280.13	194.20	202.70	282.29	321.89	322.00	323.22	(95)
-------------------------------------	--------	--------	--------	--------	--------	--------	--------	--------	--------	--------	--------	--------	------

Monthly average external temperature from Table U1	4.30	4.90	6.50	8.90	11.70	14.60	16.60	16.40	14.10	10.60	7.10	4.20	(96)
--	------	------	------	------	-------	-------	-------	-------	-------	-------	------	------	------

Heat loss rate for mean internal temperature, Lm, W [(39)m x ((93)m - (96)m)]	786.97	764.37	693.92	584.31	451.08	304.61	198.76	209.32	328.02	495.17	655.78	789.20	(97)
---	--------	--------	--------	--------	--------	--------	--------	--------	--------	--------	--------	--------	------

Space heating requirement, kWh/month 0.024 x ((97)m - (95)m) x (41)m	334.16	266.14	228.68	140.31	67.34	0.00	0.00	0.00	128.92	240.32	346.69			
	$\Sigma(98)1...5, 10...12 =$												1752.55	(98)
	$(98) \div (4) =$												31.87	(99)

Space heating requirement kWh/m ² /year													31.87	(99)
--	--	--	--	--	--	--	--	--	--	--	--	--	-------	------

9a. Energy requirements - individual heating systems including micro-CHP

Space heating														
Fraction of space heat from secondary/supplementary system (table 11)													0.00	(201)
Fraction of space heat from main system(s)	$1 - (201) =$												1.00	(202)
Fraction of space heat from main system 2													0.00	(202)
Fraction of total space heat from main system 1	$(202) \times [1 - (203)] =$												1.00	(204)
Fraction of total space heat from main system 2	$(202) \times (203) =$												0.00	(205)
Efficiency of main system 1 (%)													93.00	(206)

	Jan	Feb	Mar	Apr	May	Jun	Jul	Aug	Sep	Oct	Nov	Dec		
Space heating fuel (main system 1), kWh/month	359.31	286.17	245.89	150.87	72.41	0.00	0.00	0.00	138.62	258.41	372.78			
	$\Sigma(211)1...5, 10...12 =$												1884.46	(211)

Water heating														
Efficiency of water heater	89.16	89.10	88.96	88.66	88.07	86.70	86.70	86.70	86.70	88.55	89.00	89.20	(217)	

Water heating fuel, kWh/month	123.66	108.67	114.34	104.14	103.26	94.20	91.79	100.41	100.12	109.40	113.82	120.55		
	$\Sigma(219a)1...12 =$												1284.37	(219)

Annual totals														
Space heating fuel - main system 1													1884.46	
Water heating fuel													1284.37	
Electricity for pumps, fans and electric keep-hot (Table 4f)														
mechanical ventilation fans - balanced, extract or positive input from outside													39.84	(230a)

central heating pump or water pump within warm air heating unit	30.00			(230c)
boiler flue fan	45.00			(230e)
Total electricity for the above, kWh/year			114.84	(231)
Electricity for lighting (Appendix L)			291.28	(232)
Total delivered energy for all uses			(211)...(221) + (231) + (232)...(237b) =	3574.95 (238)

10a. Fuel costs - individual heating systems including micro-CHP

	Fuel kWh/year		Fuel price		Fuel cost £/year	
Space heating - main system 1	1884.46	x	3.48	x 0.01 =	65.58	(240)
Water heating	1284.37	x	3.48	x 0.01 =	44.70	(247)
Pumps and fans	114.84	x	13.19	x 0.01 =	15.15	(249)
Electricity for lighting	291.28	x	13.19	x 0.01 =	38.42	(250)
Additional standing charges					120.00	(251)
Total energy cost				(240)...(242) + (245)...(254) =	283.84	(255)

11a. SAP rating - individual heating systems including micro-CHP

Energy cost deflator (Table 12)	0.42	(256)
Energy cost factor (ECF)	1.19	(257)
SAP value	83.37	
SAP rating (section 13)	83	(258)
SAP band	B	

12a. CO₂ emissions - individual heating systems including micro-CHP

	Energy kWh/year		Emission factor kg CO ₂ /kWh		Emissions kg CO ₂ /year	
Space heating - main system 1	1884.46	x	0.216	=	407.04	(261)
Water heating	1284.37	x	0.216	=	277.42	(264)
Space and water heating				(261) + (262) + (263) + (264) =	684.47	(265)
Pumps and fans	114.84	x	0.519	=	59.60	(267)
Electricity for lighting	291.28	x	0.519	=	151.17	(268)
Total CO ₂ , kg/year				(265)...(271) =	895.24	(272)
Dwelling CO ₂ emission rate				(272) ÷ (4) =	16.28	(273)
EI value					88.00	
EI rating (section 14)					88	(274)
EI band					B	

13a. Primary energy - individual heating systems including micro-CHP

	Energy kWh/year		Primary factor		Primary Energy kWh/year	
Space heating - main system 1	1884.46	x	1.22	=	2299.04	(261)
Water heating	1284.37	x	1.22	=	1566.93	(264)
Space and water heating				(261) + (262) + (263) + (264) =	3865.97	(265)
Pumps and fans	114.84	x	3.07	=	352.57	(267)
Electricity for lighting	291.28	x	3.07	=	894.22	(268)
Primary energy kWh/year					5112.76	(272)
Dwelling primary energy rate kWh/m ² /year					92.98	(273)

DER Worksheet

Design - Draft



This design submission has been carried out using Approved SAP software. It has been prepared from plans and specifications and may not reflect the property as constructed.

Assessor name	Mr Simon Gowing	Assessor number	9641
Client		Last modified	29/10/2018
Address	TINDALL Oxford Road, Bodicaote, OX15		

1. Overall dwelling dimensions

	Area (m ²)	Average storey height (m)	Volume (m ³)
Lowest occupied +1	97.22 (1a) x 97.22 (1b)	2.39 (2a) x 2.61 (2b)	232.36 (3a) x 253.74 (3b)
Total floor area	(1a) + (1b) + (1c) + (1d)...(1n) = 194.44 (4)		
Dwelling volume	(3a) + (3b) + (3c) + (3d)...(3n) = 486.10 (5)		

2. Ventilation rate

	m ³ per hour
Number of chimneys	0 x 40 = 0 (6a)
Number of open flues	0 x 20 = 0 (6b)
Number of intermittent fans	6 x 10 = 60 (7a)
Number of passive vents	0 x 10 = 0 (7b)
Number of flueless gas fires	0 x 40 = 0 (7c)

Air changes per hour
 Infiltration due to chimneys, flues, fans, PSVs (6a) + (6b) + (7a) + (7b) + (7c) = 60 ÷ (5) = 0.12 (8)

If a pressurisation test has been carried out or is intended, proceed to (17), otherwise continue from (9) to (16)

Air permeability value, q50, expressed in cubic metres per hour per square metre of envelope area	5.00 (17)
If based on air permeability value, then (18) = [(17) ÷ 20] + (8), otherwise (18) = (16)	0.37 (18)
Number of sides on which the dwelling is sheltered	0 (19)
Shelter factor	1 - [0.075 x (19)] = 1.00 (20)
Infiltration rate incorporating shelter factor	(18) x (20) = 0.37 (21)

Infiltration rate modified for monthly wind speed:

	Jan	Feb	Mar	Apr	May	Jun	Jul	Aug	Sep	Oct	Nov	Dec
Monthly average wind speed from Table U2	5.10	5.00	4.90	4.40	4.30	3.80	3.80	3.70	4.00	4.30	4.50	4.70
Wind factor (22)m ÷ 4	1.28	1.25	1.23	1.10	1.08	0.95	0.95	0.93	1.00	1.08	1.13	1.18

Adjusted infiltration rate (allowing for shelter and wind factor) (21) x (22a)m

	0.48	0.47	0.46	0.41	0.40	0.35	0.35	0.37	0.40	0.42	0.44
--	------	------	------	------	------	------	------	------	------	------	------

Calculate effective air change rate for the applicable case:

If mechanical ventilation: air change rate through system N/A (23a)

If balanced with heat recovery: efficiency in % allowing for in-use factor from Table 4h N/A (23c)

d) natural ventilation or whole house positive input ventilation from loft

	0.61	0.61	0.60	0.58	0.58	0.56	0.56	0.56	0.57	0.58	0.59	0.60
--	------	------	------	------	------	------	------	------	------	------	------	------

Effective air change rate - enter (24a) or (24b) or (24c) or (24d) in (25)

0.61	0.61	0.60	0.58	0.58	0.56	0.56	0.56	0.57	0.58	0.59	0.60
------	------	------	------	------	------	------	------	------	------	------	------

3. Heat losses and heat loss parameter

Element	Gross area, m ²	Openings m ²	Net area A, m ²	U-value W/m ² K	A x U W/K	k-value, kJ/m ² .K	A x k, kJ/K
Window			62.15	1.24	76.80		
Door			2.12	1.30	2.76		
Ground floor			97.22	0.15	14.58		
External wall			145.03	0.21	30.46		
Roof			97.22	0.11	10.69		
Total area of external elements ΣA, m ²			403.74				

Fabric heat loss, W/K = Σ(A x U) (26)...(30) + (32) = 135.29 (33)
 Heat capacity Cm = Σ(A x k) (28)...(30) + (32) + (32a)...(32e) = N/A (34)
 Thermal mass parameter (TMP) in kJ/m²K 191.00 (35)
 Thermal bridges: Σ(L x Ψ) calculated using Appendix K 17.44 (36)
 Total fabric heat loss (33) + (36) = 152.73 (37)

	Jan	Feb	Mar	Apr	May	Jun	Jul	Aug	Sep	Oct	Nov	Dec
Ventilation heat loss calculated monthly 0.33 x (25)m x (5)	98.39	97.68	96.99	93.74	93.13	90.30	90.30	89.78	91.39	93.13	94.36	95.65

Heat transfer coefficient, W/K (37)m + (38)m
 251.12 250.41 249.72 246.47 245.86 243.03 243.03 242.51 244.12 245.86 247.09 248.38
 Average = Σ(39)1...12/12 = 246.47 (39)

Heat loss parameter (HLP), W/m²K (39)m ÷ (4)
 1.29 1.29 1.28 1.27 1.26 1.25 1.25 1.25 1.26 1.26 1.27 1.28
 Average = Σ(40)1...12/12 = 1.27 (40)

Number of days in month (Table 1a)
 31.00 28.00 31.00 30.00 31.00 30.00 31.00 31.00 30.00 31.00 30.00 31.00 (40)

4. Water heating energy requirement

Assumed occupancy, N 2.99 (42)
 Annual average hot water usage in litres per day Vd,average = (25 x N) + 36 105.32 (43)

	Jan	Feb	Mar	Apr	May	Jun	Jul	Aug	Sep	Oct	Nov	Dec
Hot water usage in litres per day for each month Vd,m = factor from Table 1c x (43)	115.86	111.64	107.43	103.22	99.00	94.79	94.79	99.00	103.22	107.43	111.64	115.86
	Σ(44)1...12 = 1263.88 (44)											

Energy content of hot water used = 4.18 x Vd,m x nm x Tm/3600 kWh/month (see Tables 1b, 1c 1d)
 171.81 150.27 155.06 135.19 129.72 111.93 103.72 119.02 120.45 140.37 153.22 166.39
 Σ(45)1...12 = 1657.15 (45)

Distribution loss 0.15 x (45)m
 25.77 22.54 23.26 20.28 19.46 16.79 15.56 17.85 18.07 21.06 22.98 24.96 (46)

Storage volume (litres) including any solar or WWHRs storage within same vessel 250.00 (47)

Water storage loss:
 a) If manufacturer's declared loss factor is known (kWh/day) 1.67 (48)
 Temperature factor from Table 2b 0.54 (49)
 Energy lost from water storage (kWh/day) (48) x (49) 0.90 (50)
 Enter (50) or (54) in (55) 0.90 (55)

Water storage loss calculated for each month (55) x (41)m
 27.96 25.25 27.96 27.05 27.96 27.05 27.96 27.96 27.05 27.96 27.05 27.96 (56)

If the vessel contains dedicated solar storage or dedicated WWHRs (56)m x [(47) - Vs] ÷ (47), else (56)



27.96	25.25	27.96	27.05	27.96	27.05	27.96	27.96	27.05	27.96	27.05	27.96	(57)	
Primary circuit loss for each month from Table 3													
23.26	21.01	23.26	22.51	23.26	22.51	23.26	23.26	22.51	23.26	22.51	23.26	(59)	
Combi loss for each month from Table 3a, 3b or 3c													
0.00	0.00	0.00	0.00	0.00	0.00	0.00	0.00	0.00	0.00	0.00	0.00	(61)	
Total heat required for water heating calculated for each month $0.85 \times (45)m + (46)m + (57)m + (59)m + (61)m$													
223.03	196.53	206.28	184.75	180.93	161.50	154.94	170.24	170.01	191.59	202.79	217.61	(62)	
Solar DHW input calculated using Appendix G or Appendix H													
-62.20	-54.73	-55.86	-45.94	-42.64	-35.17	-29.76	-36.03	-37.09	-45.86	-53.14	-60.12	(63)	
Output from water heater for each month (kWh/month) (62)m + (63)m													
160.83	141.80	150.42	138.82	138.29	126.33	125.19	134.21	132.92	145.72	149.65	157.49	(64)	
											$\sum(64)1...12 =$	1701.67	(64)
Heat gains from water heating (kWh/month) $0.25 \times [0.85 \times (45)m + (61)m] + 0.8 \times [(46)m + (57)m + (59)m]$													
98.10	86.97	92.53	84.60	84.10	76.87	75.46	80.55	79.70	87.65	90.60	96.30	(65)	

5. Internal gains

	Jan	Feb	Mar	Apr	May	Jun	Jul	Aug	Sep	Oct	Nov	Dec	
Metabolic gains (Table 5)													
	149.73	149.73	149.73	149.73	149.73	149.73	149.73	149.73	149.73	149.73	149.73	149.73	(66)
Lighting gains (calculated in Appendix L, equation L9 or L9a), also see Table 5													
	32.61	28.96	23.55	17.83	13.33	11.25	12.16	15.80	21.21	26.93	31.44	33.51	(67)
Appliance gains (calculated in Appendix L, equation L13 or L13a), also see Table 5													
	365.73	369.53	359.96	339.60	313.90	289.75	273.61	269.81	279.38	299.74	325.44	349.59	(68)
Cooking gains (calculated in Appendix L, equation L15 or L15a), also see Table 5													
	37.97	37.97	37.97	37.97	37.97	37.97	37.97	37.97	37.97	37.97	37.97	37.97	(69)
Pump and fan gains (Table 5a)													
	3.00	3.00	3.00	3.00	3.00	3.00	3.00	3.00	3.00	3.00	3.00	3.00	(70)
Losses e.g. evaporation (Table 5)													
	-119.79	-119.79	-119.79	-119.79	-119.79	-119.79	-119.79	-119.79	-119.79	-119.79	-119.79	-119.79	(71)
Water heating gains (Table 5)													
	131.86	129.42	124.37	117.50	113.04	106.77	101.43	108.27	110.70	117.81	125.83	129.43	(72)
Total internal gains (66)m + (67)m + (68)m + (69)m + (70)m + (71)m + (72)m													
	601.11	598.83	578.81	545.86	511.19	478.68	458.12	464.80	482.21	515.40	553.63	583.46	(73)

6. Solar gains

	Access factor Table 6d	Area m ²	Solar flux W/m ²	g specific data or Table 6b	FF specific data or Table 6c	Gains W							
South	0.77	40.64	46.75	0.9	0.63	0.70	= 580.67 (78)						
North	0.77	19.11	10.63	0.9	0.63	0.70	= 62.10 (74)						
West	0.77	0.73	19.64	0.9	0.63	0.70	= 4.38 (80)						
East	0.77	1.67	19.64	0.9	0.63	0.70	= 10.02 (76)						
Solar gains in watts $\sum(74)m... (82)m$													
	657.17	1097.84	1459.46	1760.74	1946.02	1925.07	1858.49	1718.26	1561.87	1200.43	782.86	565.37	(83)
Total gains - internal and solar (73)m + (83)m													
	1258.29	1696.67	2038.26	2306.59	2457.22	2403.75	2316.61	2183.06	2044.08	1715.83	1336.49	1148.83	(84)

7. Mean internal temperature (heating season)

Temperature during heating periods in the living area from Table 9, Th1(°C)	21.00	(85)
---	-------	------

	Jan	Feb	Mar	Apr	May	Jun	Jul	Aug	Sep	Oct	Nov	Dec		
Utilisation factor for gains for living area n1,m (see Table 9a)														
	0.99	0.98	0.95	0.88	0.76	0.60	0.45	0.49	0.71	0.92	0.98	0.99	(86)	
Mean internal temp of living area T1 (steps 3 to 7 in Table 9c)														
	19.30	19.63	20.02	20.45	20.76	20.93	20.98	20.97	20.86	20.43	19.77	19.25	(87)	
Temperature during heating periods in the rest of dwelling from Table 9, Th2(°C)														
	19.85	19.85	19.85	19.87	19.87	19.88	19.88	19.88	19.88	19.87	19.86	19.86	(88)	
Utilisation factor for gains for rest of dwelling n2,m														
	0.99	0.97	0.93	0.85	0.71	0.51	0.34	0.38	0.63	0.89	0.98	0.99	(89)	
Mean internal temperature in the rest of dwelling T2 (follow steps 3 to 7 in Table 9c)														
	17.61	18.08	18.64	19.24	19.64	19.83	19.87	19.87	19.77	19.23	18.30	17.53	(90)	
											Living area fraction	Living area ÷ (4) =	0.13	(91)
Mean internal temperature for the whole dwelling fLA x T1 + (1 - fLA) x T2														
	17.83	18.29	18.82	19.39	19.78	19.98	20.02	20.02	19.91	19.38	18.49	17.76	(92)	
Apply adjustment to the mean internal temperature from Table 4e where appropriate														
	17.68	18.14	18.67	19.24	19.63	19.83	19.87	19.87	19.76	19.23	18.34	17.61	(93)	

8. Space heating requirement

	Jan	Feb	Mar	Apr	May	Jun	Jul	Aug	Sep	Oct	Nov	Dec	
Utilisation factor for gains, ηm													
	0.98	0.96	0.91	0.83	0.69	0.51	0.34	0.38	0.62	0.87	0.97	0.99	(94)
Useful gains, ηmGm, W (94)m x (84)m													
	1238.08	1626.35	1862.19	1911.99	1700.66	1215.65	785.68	827.11	1263.70	1486.74	1291.60	1135.12	(95)
Monthly average external temperature from Table U1													
	4.30	4.90	6.50	8.90	11.70	14.60	16.60	16.40	14.10	10.60	7.10	4.20	(96)
Heat loss rate for mean internal temperature, Lm, W [(39)m x [(93)m - (96)m]													
	3359.95	3314.45	3040.06	2549.66	1950.54	1270.22	794.39	840.52	1382.21	2123.00	2778.07	3330.79	(97)
Space heating requirement, kWh/month $0.024 \times [(97)m - (95)m] \times (41)m$													
	1578.67	1134.40	876.34	459.13	185.91	0.00	0.00	0.00	0.00	473.37	1070.26	1633.58	(98)
											$\sum(98)1...5, 10...12 =$	7411.66	(98)
											(98) ÷ (4) =	38.12	(99)

9a. Energy requirements - individual heating systems including micro-CHP

Space heating														
Fraction of space heat from secondary/supplementary system (table 11)												0.00	(201)	
Fraction of space heat from main system(s)												1 - (201) =	1.00	(202)
Fraction of space heat from main system 2												0.00	(202)	
Fraction of total space heat from main system 1												(202) x [1 - (203)] =	1.00	(204)
Fraction of total space heat from main system 2												(202) x (203) =	0.00	(205)
Efficiency of main system 1 (%)												93.00	(206)	
	Jan	Feb	Mar	Apr	May	Jun	Jul	Aug	Sep	Oct	Nov	Dec		
Space heating fuel (main system 1), kWh/month														
	1697.49	1219.79	942.30	493.68	199.90	0.00	0.00	0.00	0.00	509.01	1150.82	1756.54	(211)	
											$\sum(211)1...5, 10...12 =$	7969.53	(211)	
Water heating														
Efficiency of water heater														
	88.89	88.67	88.26	87.27	85.10	79.30	79.30	79.30	79.30	87.23	88.53	88.94	(217)	
Water heating fuel, kWh/month														

180.93	159.92	170.44	159.07	162.50	159.30	157.86	169.24	167.62	167.06	169.03	177.06	
Σ(219a)1...12 =											2000.04	(219)

Annual totals

Space heating fuel - main system 1		7969.53	
Water heating fuel		2000.04	
Electricity for pumps, fans and electric keep-hot (Table 4f)			
central heating pump or water pump within warm air heating unit	30.00		(230c)
boiler flue fan	45.00		(230e)
Total electricity for the above, kWh/year		75.00	(231)
Electricity for lighting (Appendix L)		575.82	(232)
Total delivered energy for all uses	(211)...(221) + (231) + (232)...(237b) =	10620.39	(238)

10a. Fuel costs - individual heating systems including micro-CHP

	Fuel kWh/year		Fuel price		Fuel cost £/year	
Space heating - main system 1	7969.53	x	3.48	x 0.01 =	277.34	(240)
Water heating	2000.04	x	3.48	x 0.01 =	69.60	(247)
Pumps and fans	75.00	x	13.19	x 0.01 =	9.89	(249)
Electricity for lighting	575.82	x	13.19	x 0.01 =	75.95	(250)
Additional standing charges					120.00	(251)
Total energy cost				(240)...(242) + (245)...(254) =	552.78	(255)

11a. SAP rating - individual heating systems including micro-CHP

Energy cost deflator (Table 12)	0.42	(256)
Energy cost factor (ECF)	0.97	(257)
SAP value	86.47	
SAP rating (section 13)	86	(258)
SAP band	B	

12a. CO₂ emissions - individual heating systems including micro-CHP

	Energy kWh/year		Emission factor kg CO ₂ /kWh		Emissions kg CO ₂ /year	
Space heating - main system 1	7969.53	x	0.216	=	1721.42	(261)
Water heating	2000.04	x	0.216	=	432.01	(264)
Space and water heating				(261) + (262) + (263) + (264) =	2153.43	(265)
Pumps and fans	75.00	x	0.519	=	38.93	(267)
Electricity for lighting	575.82	x	0.519	=	298.85	(268)
Total CO ₂ , kg/year				(265)...(271) =	2491.20	(272)
Dwelling CO ₂ emission rate				(272) ÷ (4) =	12.81	(273)
EI value					86.06	
EI rating (section 14)					86	(274)
EI band					B	

13a. Primary energy - individual heating systems including micro-CHP

	Energy kWh/year		Primary factor		Primary Energy kWh/year	
Space heating - main system 1	7969.53	x	1.22	=	9722.83	(261)
Water heating	2000.04	x	1.22	=	2440.05	(264)
Space and water heating				(261) + (262) + (263) + (264) =	12162.88	(265)
Pumps and fans	75.00	x	3.07	=	230.25	(267)

Electricity for lighting	575.82	x	3.07	=	1767.76	(268)
Primary energy kWh/year					14160.88	(272)
Dwelling primary energy rate kWh/m ² /year					72.83	(273)

Appendix E

Low and Zero Carbon Technologies Summary

Appendix E - Low Carbon and Renewable Energy Technology Feasibility Study

Feasibility Study Table									
Technology	Sufficient Energy Generated?	Payback	Land Use Issues	Local Planning Requirements	Noise	Carbon Payback	Available Grants	Feasible?	Reason not Feasible or Selected
Combined Heat & Power (CHP)	Yes	Medium	Air quality in residential area	Encouraged for large scale developments	In Plant Room	Yes	Tax Relief - ECA, RHI	No	No available connection. High maintenance costs increasing resident bills.
Biomass	Yes	None	Air quality in residential area	Encouraged for large scale developments	In Plant Room	Yes	RHI; Bio-energy Capital Grants Scheme	No	Requires district heating to be suitable. District heating not suitable due to high costs (as CHP).
Solar Thermal	Yes	High	Sufficient roof space required	Encouraged	None	~2 years	RHI	Yes	Dependant on Hot water usage. PV More suitable
Solar Photovoltaic (PV)	Yes	Very High	Sufficient roof space required	Encouraged	None	2-5 years	FiT	Yes	Viable
Ground Source Heat Pumps (GSHPs)	Yes	High	Requires large area for coils or borehole	Encouraged	None	Low	RHI	No	No suitable space
Air Source Heat Pumps (ASHPs)	Yes	Very High	Visual intrusion of external units	None	Low	Low	RHI	No	No suitable space
Wind Power	No	Low	Urban Area - low and turbulent wind; Visual impact	Encouraged for large scale developments	Yes	~1 year	FiT	No	Wind speeds in area insufficient
Hydro Power	No	Medium	Requires suitable water resource; Visual impact	None	Low	~1 year	FiT	No	No nearby sources

1. INTRODUCTION

- > This Appendix is intended to provide the background information for the low carbon and renewable energy technologies that have been considered in the formulation of this Energy Statement.
- > The information provided here forms the basis for the project specific technical selection of low carbon/renewable energy technologies contained in the main section of this Energy Statement.

2. COMBINED HEAT AND POWER (CHP)

> CHP is a form of decentralised energy generation that generally uses gas to generate electricity for local consumption, reducing the need for grid electricity and its associated high CO₂ emissions. As the CHP system is close to the point of energy demand, it is possible to use the heat that is generated during the electricity generation process. As both the electricity and heat from the generator is used, the efficiency of the system is increased above that of a conventional power plant where the heat is not utilised.

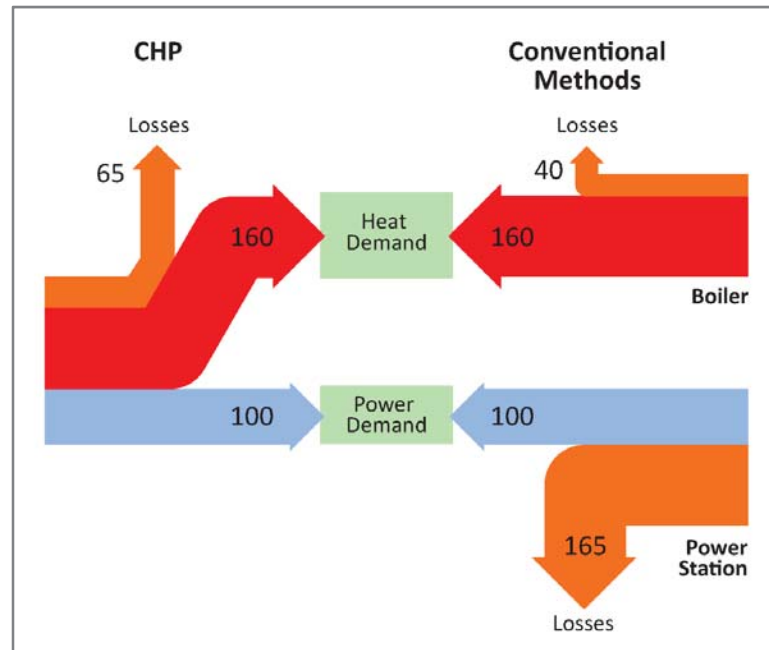

Diagram 1 – CHP Diagram

- > However, the overall efficiency of ~80% is still lower than the ~90% efficiency of a heat only gas boiler.
- > Where there are high thermal loads, CHP can be used within district heating networks to supply the required heat.
- > **Performance and Calculation Methodology: -**
 - > Most commonly sized on the heat load of a development, not the electrical load. This prevents an over-generation of heat.
 - > Require a high and relatively constant heat demand to be viable.
 - > CHP engines are best suited to providing the base heating load of a development (~year round hot water demand) with conventional gas boilers responding to the peak heating demand (~winter space heating). CHP engines are not able to effectively respond to peaks in demand.

- > In general, CHP engines have an electrical efficiency of ~30% and a thermal efficiency of ~45%. Larger engines have a better heat to power ratio and are therefore able to reduce CO₂ emissions by greater amount.
- > Electricity produced by the CHP engine displaces grid electricity which is given a carbon intensity of 0.519 kg per kWh.
- > **Capital Cost: -**
 - > Around £1,000 per kW of electrical output.
 - > Relative cost reduces as the size of engine increases.
 - > Generally best suited to larger sites, where there is a suitable economy of scale.
- > **Running Costs/Savings: -**
 - > CHP engines often struggle to provide cost-effective energy to dwellings on smaller residential schemes compared to conventional individual gas boilers.
 - > Onsite use of CHP generated electricity; power Purchase Agreement with electricity Supply Company or Private Wire arrangement to local large non-domestic demand enhances economic case.
- > **Land Use Issues and Space Required: -**
 - > CHP engines require a plant room, and possibly an energy centre for large residential developments.
 - > CHP engines require a flue to effectively disperse pollutants. This is best to rise to a minimum of 2m above the roofline of the tallest building.
 - > Route for district heating pipe around the site must be safeguarded.
- > **Operational Impacts/Issues: -**
 - > Often run by Energy Services Company (ESCO) who maybe unenthusiastic about getting involved in small – medium scale schemes.
 - > Can also be run in-house with specialist maintenance and customer services activities contracted out.
 - > Issues with rights to dig up roads for district heating networks.
 - > Emissions of oxides of nitrogen – ~500mg/kWh – 10 times higher than for a gas boiler. Specialist technologies exist (e.g. selective catalytic reduction) to reduce this to ~20mg/kWh if air quality issues require.
- > **Embodied Energy: -** Comparable to that of a conventional gas boiler.
- > **Funding Opportunities: -**
 - > Tax relief for businesses under the Enhanced Capital Allowances scheme..
- > **Reductions in Energy Achievable: -** Can provide some reductions in effective primary energy, but when distribution losses and other local losses are included more fuel is required.

- > **Reductions in CO₂ Achievable:** - Can provide greater reductions in CO₂ than energy, aided by the emissions factor of grid displaced electricity of 0.519 kg CO₂/kWh. CO₂ reduction increase as size of engine increases.
 - > **Advantages:** -
 - > Good reductions in overall primary energy and CO₂ emissions.
 - > Most cost effective and appropriate strategy to achieve substantial CO₂ reductions on large schemes.
 - > **Disadvantages:** -
 - > On smaller schemes often do not supply energy cost-effectively in comparison to conventional individual gas boilers.
 - > Requires sale of generated electricity to maximise cost effectiveness.
- Application:** - Best suited to larger developments.

3. COMBINED COOLING HEAT AND POWER (CCHP)

- > CCHP is a CHP system which additionally has the facility to transform heat into energy for cooling. This is done with an absorption chiller which utilises a heat source to provide the energy needed to drive a cooling system. As absorption chillers are far less efficient than conventional coolers (CoP of 0.7 compared to >4) they are generally only used where there is a current excess generation of heat. New CHP systems are generally sized to provide the year round base heating load only.
- > For this reason it is generally not suitable for new CHP systems to include cooling.
- > Where there are high thermal loads, CCHP can be used within district heating and cooling networks to supply the required heat and coolth.
- > **Performance and Calculation Methodology:** -
 - > Most commonly sized on the heat load of a development, not the electrical load. This prevents an over-generation of heat.
 - > Require a high and relatively constant heat and cooling demand to be viable.
 - > CCHP systems are best suited to providing the base loads of a development with conventional gas boilers and chillers responding to the peak demands. CCHP systems are not able to effectively respond to peaks in demand.

- > In general, CHP engines have an electrical efficiency of ~30% and a thermal efficiency of ~45%.
- > Absorption chillers have a CoP of ~0.7.
- > Electricity produced by the CHP engine displaces grid electricity which is given a carbon intensity of 0.519 kg per kWh.
- > **Capital Cost: -**
 - > High in comparison to biomass boilers and increased further by inclusion of absorption chiller.
- > **Running Costs/Savings: -**
 - > Coolth from absorption chillers is more expensive than from conventional systems unless heat used is genuine waste heat.
- > **Land Use Issues and Space Required: -**
 - > CCHP systems require a plant room, and possibly an energy centre for large residential developments.
 - > CHP engines require a flue to effectively disperse pollutants. This is best to rise to a minimum of 2m above the roofline of the tallest building. Additionally the absorption chiller requires either a cooling tower or dry cooler bed for heat rejection purposes.
 - > Heating and cooling distribution pipework required around the site.
- > **Operational Impacts/Issues: -**
 - > Often run by an ESCo who are unenthusiastic about getting involved in small – medium scale schemes.
 - > Can also be run in-house with specialist maintenance and customer services activities contracted out.
 - > Issues with rights to dig up roads for heat networks.
 - > Emissions of oxides of nitrogen– ~500mg/kWh – 10 times higher than for gas boilers. Specialist technologies exist (e.g. selective catalytic reduction) to reduce this ~20mg/kWh if air quality issues require.
 - > Rejection of heat is higher than for conventional cooling, thus enforcing the urban heat island effect.
 - > Embodied Energy: - Comparable to conventional gas boilers.
- > **Funding Opportunities: -**
 - > Tax relief for businesses under Enhanced Capital Allowance scheme.
 - > Reductions in Energy Achievable: - Absorption cooling generally requires more energy than conventional chillers.

- > Reductions in CO₂ Achievable: - Can provide greater reductions in CO₂ than energy, aided by the emissions factor of grid displaced electricity of 0.519 kg CO₂/kWh.
 - > **Advantages:** -
 - > Reasonable reductions in overall primary energy and CO₂ emissions.
 - > Disadvantages: - More expensive to install than conventional chillers.
 - > Operational costs higher than for conventional chillers.
 - > **Application:** - Best suited where there is genuine waste heat available.
-

4. BIOMASS BOILERS

- > Biomass boilers generate heat on a renewable basis as they are run on biomass fuel which is almost carbon neutral. Fuel is generally wood chip or wood pellets. Wood pellets are slightly more expensive than wood chips but have a significantly higher calorific value and enable greater automation of the system.
- > Various other suitable fuels are available including organic materials including straw, dedicated energy crops, sewage sludge and animal litter. Each fuel tends to have its own advantages dependant on site requirements.
- > Can be used with district heating networks or as individual boilers on a house-by-house basis.
- > **Performance and Calculation Methodology:** -
 - > Biomass boilers are best suited to providing the base heating load of a development (~year round hot water demand) with conventional gas boilers responding to the peak heating demand (~winter space heating).
 - > Operate with an efficiency of around 90%.
 - > Small models available.
 - > Conflicts with CHP they are both best suited to providing the base heating load of a development. As such they should not be installed in tandem unless surplus hot water capacity is available. Special control measures would be required in this case.
- > **Capital Cost:** -
 - > Low in comparison to CHP.
 - > More suitable to smaller developments than CHP as installed cost is lower.

- > **Running Costs/Savings: -**
 - > Biomass fuel is more expensive than gas and as such heat being provided to dwellings is generally more expensive than alternatives.
- > **Land Use Issues and Space Required: -**
 - > Biomass boilers require a plant room and possibly separate energy centre for large residential developments.
 - > Require a flue to effectively disperse pollutants. This is best to rise to a minimum of 2m above the roofline of the tallest building. Additionally the absorption chiller requires either a cooling tower or dry cooler bed for heat rejection purposes.
 - > Fuel store will be required. This should be maximised to reduce fuel delivery frequency.
 - > Space must be available for delivery vehicle to park close to plant room.
 - > Route for district heating pipe around the site must be safeguarded.
- > **Operational Impacts/Issues: -**
 - > Normally run on biomass, but can also work with biogas.
 - > Require some operational support and maintenance.
 - > Fuel deliveries required.
 - > Boiler and fuel store must be sited in proximity to space for delivery vehicle to park.
 - > Issues with rights to dig up roads, etc (for heat networks).
 - > Emissions of oxides of nitrogen – ~80-100mg/kWh.
 - > Emissions of particulate matter. To minimise this ceramic filter systems are required.
 - > Embodied Energy: - Comparable to conventional gas boiler.
- > **Funding Opportunities: -**
 - > Renewable Heat Incentive (RHI) provides incentive funds to developers of small or medium installations with a reasonable heat load that meet a minimum energy efficiency standard & meet the RHI eligibility criteria.
 - > Reductions in Energy Achievable: - No reduction in energy demand, but energy generated from a renewable fuel. Significant long term running costs (fuel).
 - > Reductions in CO₂ Achievable: - Can provide significant reductions in CO₂, but generally limited by the hot water load (base heating load).
 - > Advantages: - Reductions in CO₂ at low installed cost.

> **Disadvantages: -**

- > High long-term running costs, unless receiving RHI.
- > Often do not supply energy cost-effectively in comparison to gas boilers.

5. SOLAR THERMAL PANELS

- > Solar Thermal Heating Systems contribute to the hot water demand of a dwelling or building. Water or glycol (heat transfer fluid) is circulated to roof level where it is heated using solar energy before being returned to a thermal store in the plant room where heat is exchanged with water from the conventional system. Due to the seasonal availability of heat, solar thermal panels should be scaled to provide no more than 1/2 of the hot water load.

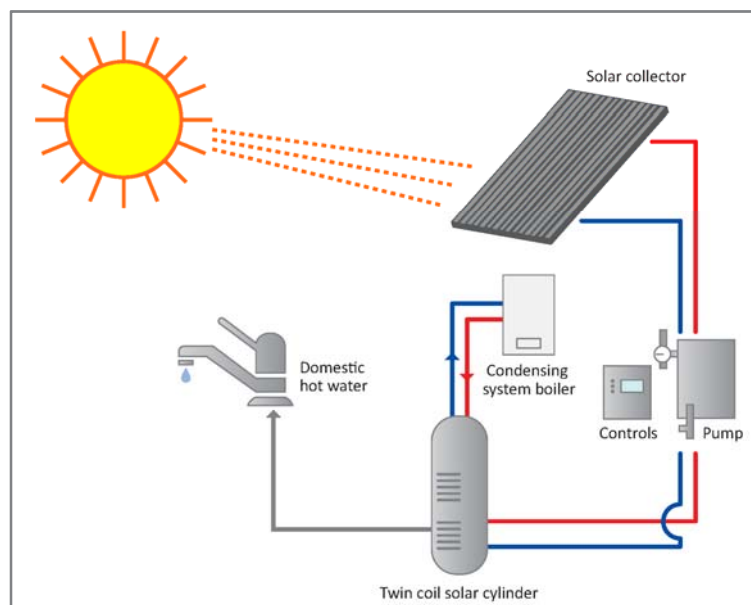

Diagram 2 – Solar Thermal System

- > Can also be used to provide energy for space heating in highly insulated dwellings.
- > There are two types of solar thermal panel: evacuated tube collectors and flat plate collectors.
- > **Performance and Calculation Methodology: -**
 - > Evacuated Tube Collectors: ~60% efficiency.
 - > Flat Plate Collectors: ~50% efficiency.
 - > SAP Table H2 used for solar irradiation at different angles.

- > Operate best on south facing roofs angled at 30-45° and free of shading, or on flat roofs on frames. East/West facing panels suffer a loss in performance of 15-20% depending on the angle of installation.
- > Flat plate collectors cannot be installed horizontally as this would prevent operation of the water pump. Must therefore be angled and separated to avoid overshadowing each other.
- > **Capital Cost:** - Typically £2,500 per 4m² plus installation. Costs higher for evacuated tubes than flat plate collectors.
- > **Running Costs/Savings:** -
 - > Reduce reliance on gas and therefore reduce costs.
 - > Payback period of ~20 years per dwelling.
- > **Land Use Issues and Space Required:** -
 - > Installed on roof so no impact on land use.
 - > Requires hot water cylinders in dwellings.
 - > Due to amount of roof space required and distance from tank to panels, less suitable for dense developments of relatively high rise flats.
 - > Within permitted development rights unless in a conservation area where they must not be visible from the public highways.
 - > Dormer and Velux windows may conflict if energy/CO₂ reduction required is large.
- > **Operational Impacts/Issues:** - Biggest reductions achieved by people who operate their hot water system with consideration of the panels.
 - > Embodied Energy: - Carbon payback is ~2 years.
 - > Funding Opportunities: - none
- > **Reductions in Energy Achievable:** - Reduce primary energy demand by more per standard panel area than solar PV panels.
 - > Reductions in CO₂ Achievable: - Comparable to solar PV per m².
- > **Advantages:** - Virtually free fuel, low maintenance and reductions in energy/CO₂.
- > **Disadvantages:** - Benefits limited to maximum ~50% of hot water load.
 - > Higher Costs in comparison to PV
- > **Application:** - Best suited for small to medium housing developments ~1-100

6. SOLAR PHOTOVOLTAIC (PV) PANELS

- > Solar PV panels generate electricity by harnessing the power of the sun. They convert solar radiation into electricity which can be used on site or exported to the grid in times of excess generation.
- > **Performance and Calculation Methodology: -**
 - > The best PV panels operate with an efficiency approaching 20%. ~7m² of these high performance panels will produce 1kWp of electricity.
 - > Operate best on south facing roofs angled at 30-45° or on flat roofs on frames. Panels orientated east/west suffer from a loss in performance of 15-20% depending on the angle of installation.
 - > Must be free of any potential shading.
 - > Cannot be installed horizontally as would prevent self-cleaning. Must therefore be angled and separated to avoid overshadowing each other.
 - > Electricity produced displaces grid electricity which has a carbon intensity of 0.519 kg CO₂ per kWh.
- > **Capital Cost: -** ~£2,000 per kWp.
- > **Running Costs/Savings: -**
 - > Reduce reliance on grid electricity and therefore reduce running costs.
 - > At current electricity prices, payback period of ~60-70 years per dwelling.
 - > Feed-in tariff and Renewables Obligation Certificates (ROCs) payments required for maximum financial benefit.
- > **Land Use Issues and Space Required: -**
 - > Installed on roof so no impact on land use.
 - > Due to amount of roof space required are less suitable for dense developments of relatively high rise flats.
 - > Within permitted development rights unless in a conservation area where they must not be visible from the public highways.
 - > Dormer and Velux windows may conflict if energy/CO₂ reduction required is large.
- > **Operational Impacts/Issues: -**
 - > Proportionately large arrays may need electrical infrastructure upgrade.

- > Virtually maintenance free and panels are self-cleaning at angles in excess of 10 degrees.
- > Provision for access to solar panels installed on flat roofs needs to be incorporated into the design of PV arrays layout as well as inclusion of spaces for inverters within the development.
- > Quality of PV panels varies dramatically.
- > **Embodied Energy:** - Carbon payback of 2-5 years.
- > **Funding Opportunities:** - Financier utilising Feed-in-Tariffs.
- > **Reductions in Energy Achievable:** - Reduce energy demand by less per m² than solar thermal panels.
- > **Reductions in CO₂ Achievable:** - Provide greater percentage reductions in CO₂ than energy. Comparable to solar thermal per square metre.
- > **Advantages:** - Virtually free fuel, very low maintenance and good reductions in CO₂.
 - > Cheaper in comparison to solar thermal panels.
- > **Disadvantages:** -
 - > Slightly greater loss in performance than solar thermal panels when orientated away from south.
- > **Application:** Best suited for a variety of developments from single houses to multi apartment blocks and even whole estates.

7. GROUND SOURCE HEAT PUMPS (GSHPS)

- > Ground Source Heat Pumps work in much the same way as a refrigerator, converting low grade heat from a large 'reservoir' into higher temperature heat for input in a smaller space. Electricity drives the pump which circulates a fluid (water/antifreeze mix or refrigerant) through a closed loop of underground pipe. This fluid absorbs the solar

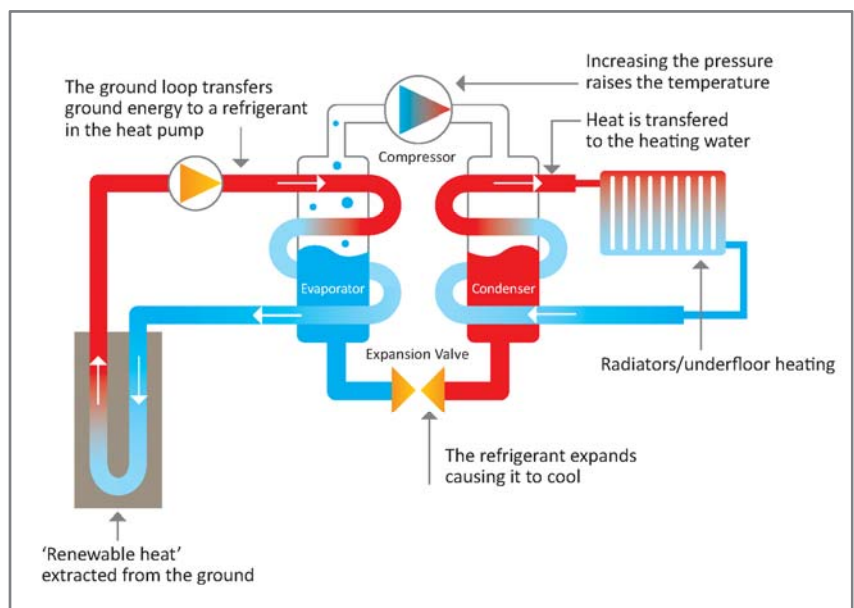

Diagram 3 – Ground Source Heat Pump

energy that is stored in the earth (which in the UK remains at a near constant temperature of 12°C throughout the year) and carries it to a pump. A compressor in the heat pump upgrades the temperature of the fluid which can then be used for space heating and hot water.

> **Performance and Calculation Methodology: -**

- > System requires electricity to drive the pump. Therefore displaces gas heating with electric, which has higher carbon intensity (gas: 0.216; electricity: 0.519).
- > As they are upgrading heat energy from the earth, GSHPs operate at 'efficiencies' in excess of 350%. This is limited in SAP unless Appendix Q rated model used.
- > Due to the lower temperature of the output of GSHPs compared to traditional gas boilers, GSHPs work best in well insulated buildings and with underfloor heating. They can, however, also be installed with oversized radiators, albeit with a consequent reduction in performance.

> **Capital Cost: -** ~£7,500 per house. Additional costs if underfloor heating is to be installed.

> **Running Costs/Savings: -**

- > Electricity more expensive than gas, thus fuel costs not reduced as much as energy is reduced.
- > Payback period of ~20 years per dwelling.

> **Land Use Issues and Space Required: -**

- > Require extensive ground works to bury the coils that extract the low grade heat from the earth. They therefore require a large area for horizontal burial (40-100m long trench) or a vertical bore (50-100m) which is considerably more expensive but can be used where space is limited.
- > Best suited to new developments that have provision for large ground works already in place, to minimise ground work costs.
- > Must be sized correctly to prevent freezing of the ground during winter and consequent shutdown of the system.
- > May require planning permission for engineering works. Once buried, there is no external evidence of the GSHPs.

> **Operational Impacts/Issues: -**

- > Work best in well insulated houses.
- > Need immersion backup for hot water.

- > Highly reliable and require virtually no maintenance.
- > Problems if ground bore fails.
- > **Embodied Energy:** - Low, but as gas is being replaced with the more carbon intensive electricity, carbon payback is slowed. Carbon payback depends on CoP.
- > **Funding Opportunities:** - Renewable Heat Incentive (RHI) provides incentive funds to developers of small or medium installations with a reasonable heat load that meet a minimum energy efficiency standard & meet the RHI eligibility criteria.
- > **Reductions in Energy Achievable:** - Reduce energy demand by less per m² than solar thermal panels.
- > **Reductions in CO₂ Achievable:** - Provide greater %age reductions in CO₂ than energy. Comparable to solar thermal (esp. in SAP).
- > **Advantages:** - Large reductions in Energy. Currently receives benefit from SAP of an electrical baseline rather than gas.
- > **Disadvantages:** -
 - > Small reduction in CO₂. CoP limited in SAP. Only small cost savings.
 - > GSHPs are not entirely a 'renewable' technology as they require electricity to drive their pumps or compressors.
- > **Application:** - Best suited for small to medium developments ~1-100

8. AIR SOURCE HEAT PUMPS (ASHPS)

- > Air Source Heat Pumps work in much the same way as a refrigerator, converting low grade heat from a large 'reservoir' into higher temperature heat for input into a smaller space. Electricity drives the pump which extracts heat from the air as it flows over the coils in the heat pump unit. A compressor in the heat pump upgrades the temperature of the extracted energy which can then be used for space heating and hot water.

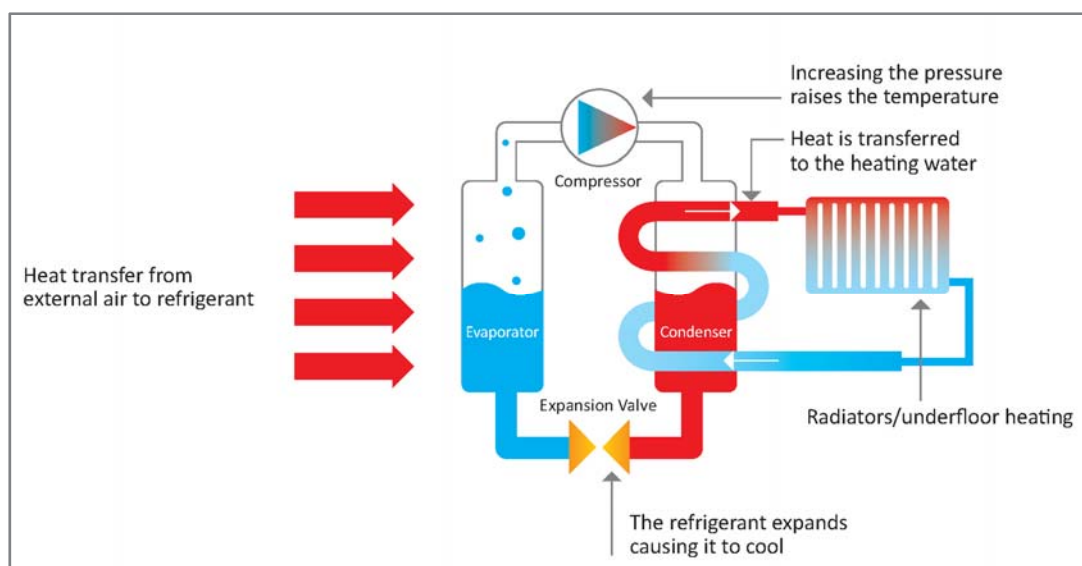

Diagram 4 – Air Source Heat Pump

- > Generally ASHPs are air-to-water devices but can also be air-to-air.
- > **Performance and Calculation Methodology: -**
 - > System requires electricity to drive the pump. Therefore displaces gas heating with electric, which has higher carbon intensity (gas: 0.216; electricity: 0.519).
 - > Performance defined by the Coefficient of Performance (CoP) which is a measure of electricity input to heat output. However, the concept of a CoP must be treated with caution as it is an instantaneous measurement and does not take account of varying external conditions throughout the year.
 - > As they are upgrading heat energy from the air, ASHPs operate at 'efficiencies' in excess of 250%. This is limited in SAP unless an Appendix Q rated model is used.
 - > British winter conditions (low temperatures and high humidity) lead to freezing of external unit. Reverse cycling defrosts the ASHP, but can substantially reduce performance when it is most needed. Performance under these conditions varies considerably between models. Vital that ASHP that has been proven in British winter conditions is installed.
 - > Due to the lower temperature of the output of ASHPs compared to traditional gas boilers, ASHPs work best in well insulated buildings and with underfloor heating. They can, however, also be installed with oversized radiators, albeit with a consequent reduction in performance.
- > **Capital Cost: -** ~£2,000 per house.
- > **Running Costs/Savings: -**
 - > Electricity more expensive than gas, thus fuel costs not reduced as much as energy is reduced.
 - > Payback period of ~10 years per dwelling.
- > **Land Use Issues and Space Required: -**
 - > No need for external ground works, only a heat pump unit for the air to pass through.
 - > Minimal external visual evidence.
- > **Operational Impacts/Issues: -**
 - > Work best in well insulated houses.
 - > Unit must be sized correctly for each dwelling.
 - > Vital that ASHP model selected has been proven to maintain performance at the low temperature and high humidity conditions of the British winter.

- > May need immersion backup for hot water.
 - > Highly reliable and require virtually no maintenance.
 - > Noise from ASHPs must be below 42 dB at a position one metre external to the centre point of any door or window in a habitable room. According to planning standards MCS020.
 - > **Embodied Energy:** - Low. Carbon payback longer than for GSHPs as the CoP is lower.
 - > **Funding Opportunities:** - Renewable Heat Incentive (RHI) provides incentive funds to developers of small or medium installations with a reasonable heat load that meet a minimum energy efficiency standard & meet the RHI eligibility criteria.
 - > **Reductions in Energy Achievable:** - Large reductions in energy demand. Less so than GSHPs.
 - > **Reductions in CO₂ Achievable:** - Provide smaller percentage reductions in CO₂ than energy. Less than GSHPs.
 - > **Advantages:** - Large reductions in Energy. Currently receives benefit from SAP of an electrical fuel factor rather than a gas baseline.
 - > **Disadvantages:** -
 - > Small reduction in CO₂ CoP limited in SAP. Only small cost savings.
 - > ASHPs are not entirely a 'renewable' technology as they require electricity to drive their pumps or compressors.
 - > **Application:** - Best suited for small to medium developments ~1-100
-

9. WIND POWER

- > Wind energy installations can range from small domestic turbines (1kW) to large commercial turbines (140m tall, 2MW). There are also different designs and styles (horizontal or vertical axis; 1 blade to multiple blades) to suit the location. They generate clean electricity that can be provided for use on-site, or sold directly to the local electricity network
- > **Performance and Calculation Methodology:** -
 - > Power generated is proportional to the cube of the wind speed. Therefore, wind speed is critical.
 - > Horizontal axis turbines require >~6m/s to operate effectively and vertical axis turbines require >~4.5m/s. The rated power of a turbine is often for wind speeds double these figures.
 - > Wind speeds for area from BERR's Wind Speed Database.
 - > Electricity produced displaces grid electricity which has a carbon intensity of 0.568 kg/kWh.

> **Capital Cost: -**

- > ~£1,000 per kW. Smaller models are more expensive per kW.
- > Vertical axis turbines more expensive than horizontal.

> **Running Costs/Savings: -**

- > Reduce reliance on grid electricity and therefore reduce costs.
- > Payback period of ~15-20 years per dwelling.
- > Feed-in tariff and ROC payments required for maximum financial benefit.

> **Land Use Issues and Space Required: -**

- > Smaller models (<6kW) can be roof mounted.
- > Must be higher than surrounding structures/trees.
- > Planning permission required.

> **Operational Impacts/Issues: -**

- > Urban environments generally have low wind speeds and high turbulence which reduce the effectiveness of turbines.
- > Vertical axis turbines have a lower performance than horizontal axis turbines but work better in urban environments.
- > Annual services required.
- > Turbines rated in excess of 5kW may require the network to be strengthened and arrangements to be made with the local Distribution Network Operator and electricity supplier.
- > Noise.

> **Embodied Energy: -** Carbon payback is ~1 year for most turbines.

> **Funding Opportunities: -** Financier utilising Feed-in-Tariffs.

> **Reductions in Energy Achievable: -** Significant reduction in reliance on grid electricity.

> **Reductions in CO₂ Achievable: -** Good. Greater reduction in CO₂ than PV for same investment.

> **Advantages: -** Virtually free fuel; reductions in CO₂.

> **Disadvantages: -**

- > Expensive, although cheaper than PV for same return.
- > Lack of suitable sites.

- > Maintenance costs.
 - > Often not building integrated.
 - > **Application:** Best suited for small to large developments in rural open areas
-

10. HYDRO POWER

- > Hydro power harnesses the energy of falling water, converting the potential or kinetic energy of water into electricity through use of a hydro turbine. Micro hydro schemes (<100kW) tend to be 'run-of-river' developments, taking the flow of the river that is available at any given time and not relying on a reservoir of stored water. They generate clean electricity that can be provided for use on-site, or sold directly to the local electricity network.
- > **Performance and Calculation Methodology:** -
 - > Flow rates at particular sites from National River Flow Archive held by Centre for Ecology and Hydrology.
 - > Electricity produced displaces grid electricity which has a carbon intensity of 0.568 kg/kWh.
- > **Capital Cost:** -
 - > £3,000 - £5,000 per kW.
 - > Particularly cost effective on sites of old water mills where much of the infrastructure is in place.
- > **Running Costs/Savings:** -
 - > Reduce reliance on grid electricity and therefore reduce costs.
 - > Payback period of ~10-15 years per dwelling
 - > Feed-in tariff and ROC payments required for maximum financial benefit.
- > **Land Use Issues and Space Required:** -
 - > Require suitable water resource.
 - > Visual intrusion of scheme.
 - > Special requirements where river populated by migrating species of fish.
 - > Planning permission will require various consents and licences including an Environmental Statement and Abstraction Licence.
- > **Operational Impacts/Issues:** -
 - > Routine inspections and annual service required.
 - > Automatic cleaners should be installed to prevent intake of rubbish.
- > **Embodied Energy:** - Carbon payback for small schemes of ~1 year.

- > **Funding Opportunities:** - Financier utilising Feed-in-Tariffs.
- > **Reductions in Energy Achievable:** - significant reduction in reliance on grid electricity.
- > **Reductions in CO₂ Achievable:** - High.
- > **Advantages:** - Virtually free fuel, reductions in CO₂.
- > **Disadvantages:** -
 - > Expensive, but good payback period.
 - > Lack of suitable sites.
 - > Planning obstructions.
- > **Application:** - Best suited to medium to larger developments in rural places ~ 100+ units

Appendix F

SAP 2012 PV Calculation and indicative layout

Photovoltaic Generation

PV Array 1			
Required Roof Area	233 m ²	Peak Power Output	29.12 kWp
Overshading	None	Solar Radiation	1,029 kWh/m ²
Angle from North	135 °	Energy Generation	23,976 kWh/year
Pitch from Horizontal	30 °	CO ₂ Emissions Offset	12,444 kg CO ₂ /year

PV Array 2			
Required Roof Area	72 m ²	Peak Power Output	8.96 kWp
Overshading	None	Solar Radiation	1,004 kWh/m ²
Angle from North	225 °	Energy Generation	7,197 kWh/year
Pitch from Horizontal	45 °	CO ₂ Emissions Offset	3,735 kg CO ₂ /year



- KEY: SITE LAYOUT**
- APPLICATION BOUNDARY
- SURFACE MATERIALS:**
- GARDEN/POS/HIGHWAY VERGE (SEE DETAILED LANDSCAPE PROPOSALS)
 - TARMACADAM
 - BLOCK PAVING
 - CONCRETE SLAB
- ENCLOSURE DETAILS:**
- 1.8M HIGH BRICK WALL (BW)
 - 1.8M HIGH TIMBER PANEL FENCING (PF)
 - 1.8M HIGH CLOSE BOARDED FENCING (CBF)
 - 1M HIGH BOW TOP RAILINGS
- LANDSCAPING:**
- RETAINED TREE
 - INDICATIVE TREE PLANTING (SEE DETAILED LANDSCAPE PROPOSALS)
- OTHER:**
- DWELLING PLOTTED AS SHOWN IN HOUSE PACK
 - DWELLING HANDED FROM HOUSE PACK
 - AFFORDABLE HOUSING (SHARED OWNERSHIP)
 - AFFORDABLE HOUSING (RENTED)
 - BIN COLLECTION POINT
 - GATE/PERSONNEL DOOR
 - PROPOSED DRAINAGE EASEMENT
 - SECURE CYCLE PARKING

Indicative PV
Layout.
For illustration
purposes only.
29 kWp SE facing
9 kWp SW facing

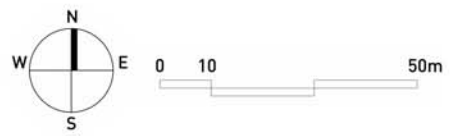

Accommodation Schedule

Unit Type	No. Beds	Stores	Sqft/Unit	Sqms/Unit	No. of Units
UNASSIGNED	0	0	0	0	0
HARTLEY	3	0	991	92.4	6
HUNTWOOD	3	0	1,017	95.4	6
LONGHORN	3	0	1,100	102.7	6
HALL STRAD	2	0	1,170	108.8	6
ADON	4	0	1,399	129.5	6
SHAMPORE	4	0	1,514	142.7	6
VALDER	4	0	1,537	143.7	6
RADLEY	4	0	1,579	146.7	6
CALDWICK	4	0	1,723	160.7	6
TRIGG	5	0	2,118	196.8	6
ACKERSHURTY	5	0	2,381	223.3	6
OW TOTAL					60
Affordable					
RENTED					
AVON	0	0	769	71.6	3
WHELETH	2	0	874	81.2	3
WHELETH	2	0	1,130	105.2	3
WHELETH	3	0	1,311	122.4	3
WHELETH	3	0	1,528	142.5	3
Sub Total					15
INTERMEDIATE					
WHELETH	0	0	769	71.6	0
WHELETH	2	0	874	81.2	0
Sub Total					0
APP TOTAL					75
TOTAL LIMITS					75

OXFORD ROAD, BODICOTE - COMPOSITE SITE LAYOUT Pegasus Design

Appendix G

CO₂ Calculations Summary Sheet (With PV)

Appendix G

CO₂ Emissions at Be Green Stage

Unit Type Description	Individual			Number of Units	Total			Emissions Rate Improvement
	Unit Floor Area	Dwelling Emissions Rate	Target Emissions Rate		Total Floor Area	Dwelling Emissions Rate	Target Emissions Rate	
	m ²	kg CO ₂ /m ² /year	kg CO ₂ /m ² /year		m ²	kg CO ₂ /year	kg CO ₂ /year	-
Domestic								
ADDERBURY (detached)	115	15.7	17.0	4	459	7,221	7,788	7.3%
AH2B (semi-detached/end terrace)	78	16.0	18.3	18	1,408	22,497	25,808	12.8%
AH3B (mid terrace)	78	14.7	17.5	1	78	1,149	1,366	15.8%
CALDER (detached)	138	14.3	16.2	3	413	5,911	6,709	11.9%
CALDERWICK (detached)	165	13.9	15.7	8	1,319	18,340	20,717	11.5%
Ground Floor apartment	44	18.4	22.3	2	87	1,608	1,944	17.3%
AH23B (semi-detached/end terrace)	93	15.7	17.9	10	925	14,481	16,545	12.5%
HALSTEAD (semi-detached)	111	14.6	15.7	8	889	13,015	13,989	7.0%
HARTLEY AND SANDOWN (semi-detached)	93	15.2	17.4	10	930	14,088	16,193	13.0%
LANFORD AND HUNTINGFORD (detached)	101	16.3	17.9	8	809	13,224	14,503	8.8%
RADLEY (detached)	147	16.0	17.3	10	1,471	23,579	25,392	7.1%
SOMERTON (detached)	139	15.2	16.4	7	972	14,806	15,971	7.3%
Top Floor apartment	55	16.3	20.0	2	110	1,790	2,198	18.5%
TINDALL (detached)	194	12.8	13.9	4	778	9,965	10,782	7.6%
Total CO ₂ Emissions Offset by PV						16,179		
Total for All Units					10,649	145,496	179,904	19.1%

Appendix H

Water Efficiency Calculator

Water Efficiency Calculator (Internal: 105 litres/person/day)				
Oxford Road, Bodicote				
Internal Water Consumption				
Installation Type	Unit of Measure	Capacity / Flow Rate	Litres/person/day	Notes
WC	Full Flush Volume (Litres)	6	8.76	Low flush WCs will be installed to reduce the volume of water consumed during flushing. All WCs will have dual flush cisterns which will provide both part (3L) and full (6L) flushes.
	Part Flush Volume (Litres)	3	8.88	
Bath	Capacity (Litres to overflow)	165	18.15	All baths will have reduced capacities of 165 litres (excluding displacement). The bath taps are not included in this calculation as they are already incorporated into the use factor for the baths.
Shower	Flow Rate (Litres/min)	8	34.96	Shower flow rates will be reduced to 8 litres/minute using flow restrictors fixed to the shower heads. These contain precision-made holes or filters to restrict water flow and reduce the outlet flow and pressure.
Kitchen Tap	Flow Rate (Litres/min)	8	13.88	Kitchen taps will be reduced to 8 litres/minute using flow restrictors which will be fitted within the console of the tap or in the pipework.
Basin Tap	Flow Rate (Litres/min)	4	7.55	All taps (excluding kitchen taps) will be reduced to 3.78 litres/minute using flow restrictors. Where multiple taps are to be provided the average flow rate will be used.
Washing Machine	Water Consumption (Litres/kg)	8.17	17.16	Water efficient washing machines or washer-dryers will be specified. The make and model numbers of the appliances are unknown at this stage therefore a default figure of 8.17 litres/kg has been assumed.
Dishwasher	Water Consumption (Litres/place setting)	1.25	4.51	All dishwashers will be water efficient. The make and models numbers are unknown therefore a default figure of 1.25 litres/place setting has been assumed at this stage.
Net Internal Water Consumption (Litres/person/day)			113.8	
Normalisation Factor			0.91	
Total Water Consumption (Litres/person/day)			103.6	The internal water consumption target of ≤105 litres/person/day will be achieved.