

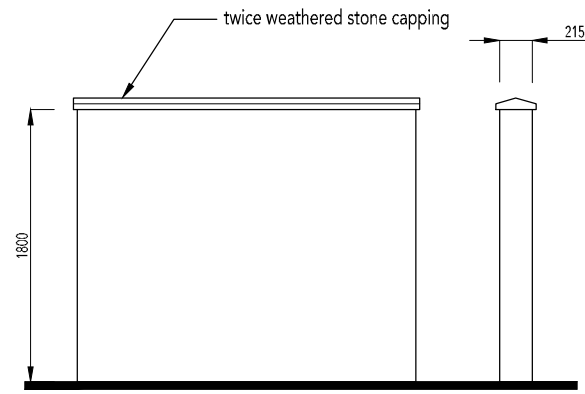

REVISION/S:

- A. 2017-06-08. 1350mm high piers, field gate and knee rail added to the External Detailing Sheet to suit revised Planning Layout. DW



1800mm High Screen Wall

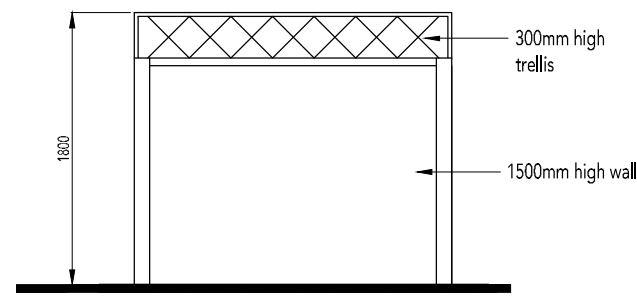

300mm High Trellis on 1500mm High Screen Wall

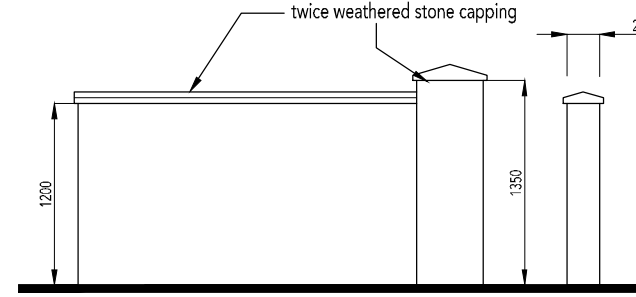

1200mm High Screen Wall with 1350mm High Pier

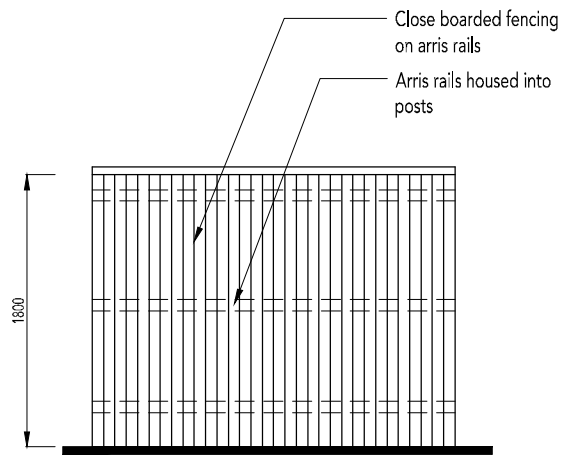

1800mm High Close Board Timber Fence

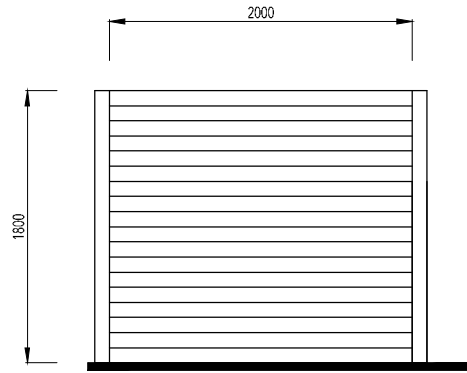

1800mm High Plot Division Panel Fence

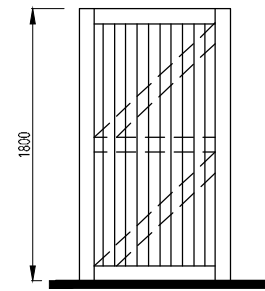

1800mm High Timber Matchboard Access Gate

PLEASE NOTE:

MATERIALS TO SCREEN WALLS & MASONRY PIERS TO BE INDICATED ON MATERIALS LAYOUT DRG NO: 0521-PH9-108.



300mm High Timber Knee Railing

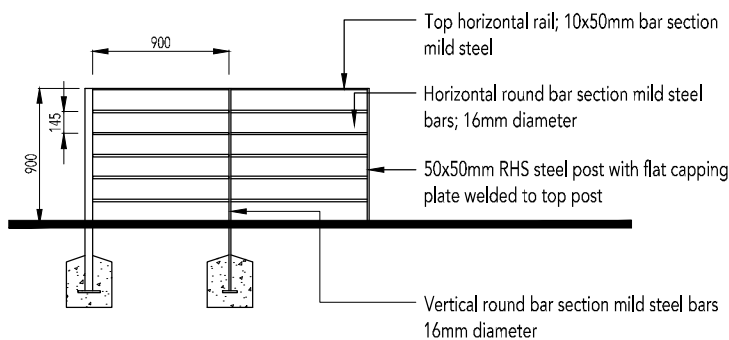

900mm High Metal Estate Railings

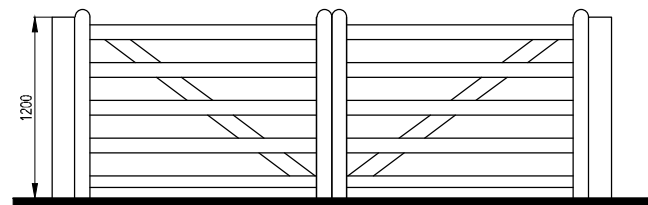

1200mm High Timber Field Gate

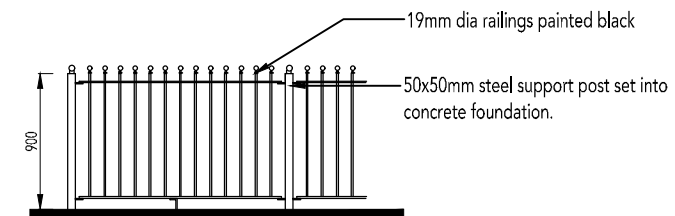

900mm High Metal Railings