

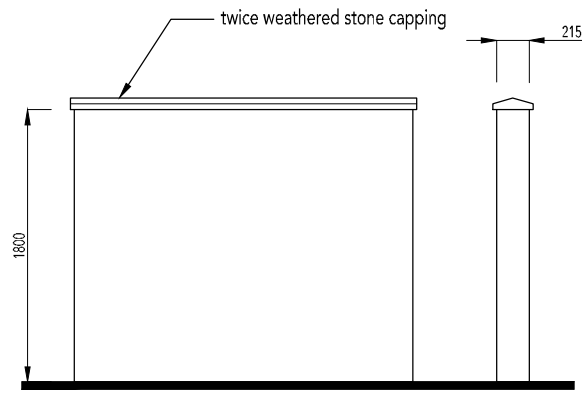

REVISION/S:

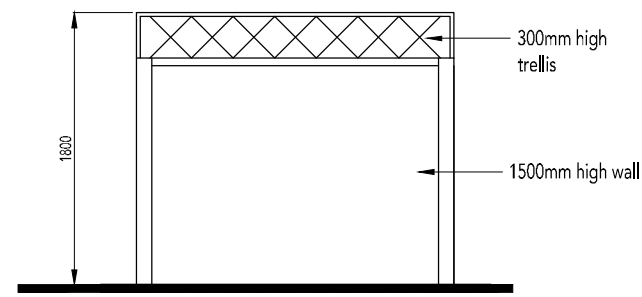

1800mm High Screen Wall



300mm High Trellis on 1500mm High Screen Wall

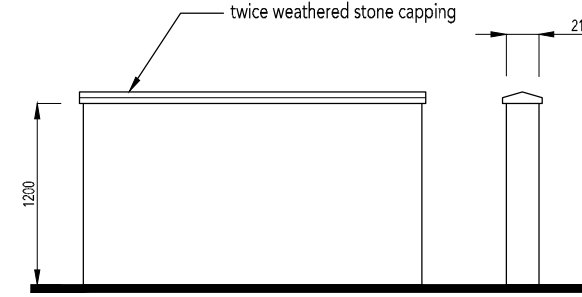

1200mm High Screen Wall

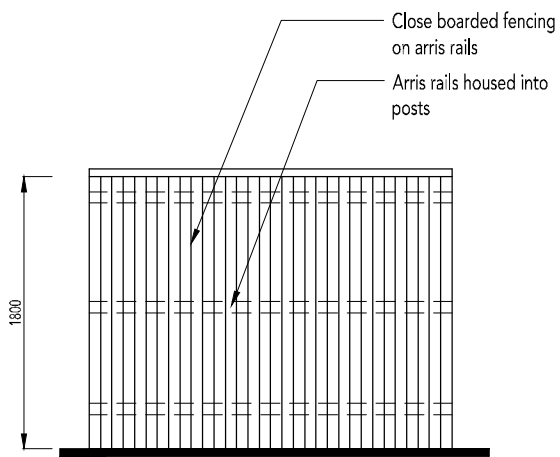

1800mm High Close Board Fence

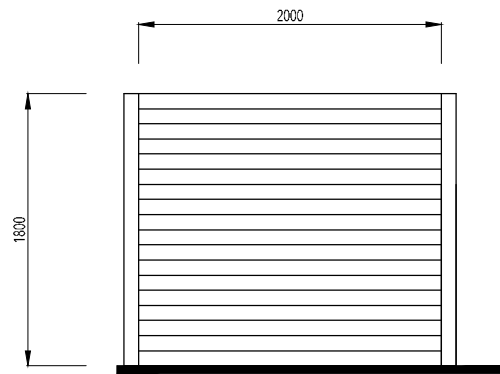

1800mm High Plot Division Panel Fence

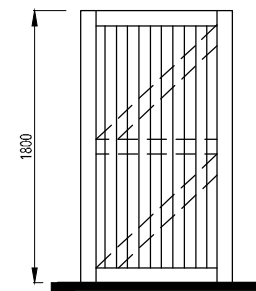

1800mm High Timber Matchboard Access Gate

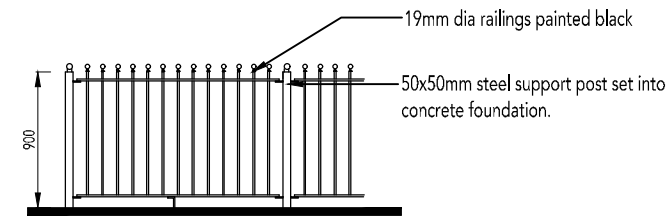

900mm High Metal Railings

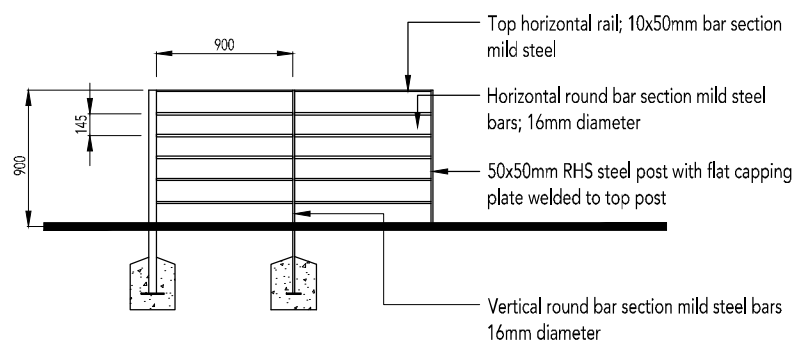

900mm High Estate Railings

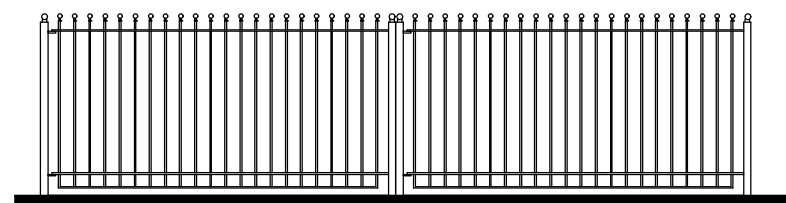

1200mm High Railing Gate

PLEASE NOTE:

MATERIALS TO SCREEN WALLS & MASONRY PIERS TO BE INDICATED ON MATERIALS LAYOUT DRG NO: 0521-PH9-108.