



**Geophysical survey and archaeological evaluation  
at Banbury Road, Bodicote  
Oxfordshire  
June 2014**

Report No. 14/143

Authors: Yvonne Wolframm-Murray  
John Walford

Illustrators: Amir Bassir  
John Walford (Geophysics)



# Geophysical survey and archaeological evaluation at Banbury Road, Bodicote Oxfordshire June 2014

Report No. 14/143

Quality control and sign off:

Issue No.	Date approved:	Checked by:	Verified by:	Approved by:	Reason for Issue:
1	22.07.14	Pat Chapman	Adam Yates	Andy Chapman	Draft for review
2	04.08.14	Pat Chapman	Adam Yates	Andy Chapman	Draft for review
3	24.09.14	Pat Chapman	Adam Yates	Andy Chapman	Approved version

Author: Yvonne Wolframm-Murray

John Walford

Illustrators: Amir Bassir

John Walford

© MOLA Northampton 2014

MOLA  
Bolton House  
Wootton Hall Park  
Northampton  
NN4 8BN  
01604 700 493  
[www.mola.org.uk](http://www.mola.org.uk)  
[sparry@mola.org.uk](mailto:sparry@mola.org.uk)

## STAFF

Project Manager: Adam Yates BA MfA

Fieldwork: Ian Fisher BSc  
Yvonne Wolframm-Murray BSc PhD  
Adam Reid BSc MSc  
David Hayes  
Ben Kidd BA  
Mo Muldowney BA AlfA

Text: Yvonne Wolframm-Murray  
John Walford BSc MSc

Iron Age pottery and slag: Andy Chapman BSc MfA FSA

Worked flint: Yvonne Wolframm-Murray

Romano-British, medieval and  
post-medieval pottery: Paul Blinkhorn BTech

Clay tobacco-pipe Tora Hylton

Charred plant macrofossils: Val Fryer BA MfA

Animal bone: Adam Reid

Illustrations: Amir Bassir BSc  
John Walford

## OASIS REPORT FORM

<b>PROJECT DETAILS</b>		<b>Oasis No. molanort1-184508</b>	
Project title	Geophysical survey and archaeological evaluation at Banbury Road, Bodicote, Oxfordshire		
Short description	A geophysical survey and trial trench evaluation was undertaken on land at Banbury Road, Bodicote, Oxfordshire in June 2014. Eleven trenches were targeted on anomalies identified by the geophysical survey. The anomalies comprised a large sub-rectangular ditched enclosure and linear and curvilinear anomalies. A ring ditch was also detected at the northern edge of the survey area. The evaluation confirmed the presence of the anomalies and showed the enclosure ditches to be substantial. Additionally, two potential cremation burials were noted. These features are difficult to characterise to period due to lack of datable artefacts.		
Project type	Geophysical survey and trial trench evaluation		
Site Status	-		
Previous work	None		
Current land use	Arable Field		
Future work	unknown		
Monument type and period	Iron Age/Roman		
Significant finds	-		
<b>PROJECT LOCATION</b>			
County	Oxfordshire		
Site address	Banbury Road, Bodicote		
Post code	-		
OS co-ordinates	SP 4670 3728		
Area (sq m/ha)	3.9ha		
Height aOD	105-113m aOD		
<b>PROJECT CREATORS</b>			
Organisation	MOLA Northampton		
Project brief originator	Oxfordshire County Council Archaeological Services		
Project Design originator	RPS		
Director/Supervisor	Yvonne Wolfram-Murray and Ian Fisher		
Project Managers	Adam Yates		
Sponsor or funding body	Rowland Bratt		
<b>PROJECT DATE</b>			
Start date	8 June 2014 (Geo) 16 June 2014 (Evaluation)		
End date	20 June 2014 (Evaluation)		
<b>ARCHIVES</b>	<b>Location (Accession no.)</b>	<b>Contents</b>	
Physical	Oxfordshire County Museum	Pottery and flint	
Paper		Site records (1 small archive box)	
Digital		Client report PDF	
<b>BIBLIOGRAPHY</b>	Journal/monograph, published or forthcoming, or unpublished client report (NA report)		
Title	Geophysical survey and archaeological evaluation on land at Banbury Road, Bodicote, Oxfordshire		
Serial title & volume	14/143		
Author(s)	Yvonne Wolfram-Murray and John Walford		
Page numbers	53		
Date	24/09/2014		

# Contents

- 1 INTRODUCTION
  - 2 BACKGROUND
    - 2.1 Location and topography
    - 2.2 Historical and archaeological background
  - 3 OBJECTIVES AND METHODOLOGY
    - 3.1 The geophysical survey methodology by John Walford
    - 3.2 The trial trench evaluation methodology
  - 4 THE GEOPHYSICAL SURVEY by John Walford
  - 5 THE TRIAL TRENCH EVALUATION by Yvonne Wolframm-Murray
    - 5.1 General Comments
    - 5.2 Trench 2
    - 5.3 Trench 3
    - 5.4 Trench 4
    - 5.5 Trench 6
    - 5.6 Trench 7
    - 5.7 Trench 8
    - 5.8 Trench 9
    - 5.9 Trench 10
    - 5.10 Trench 11
  - 6 THE FINDS
    - 6.1 Worked flint by Yvonne Wolframm-Murray
    - 6.2 Prehistoric pottery and fired clay by Andy Chapman
    - 6.3 Slag by Andy Chapman
    - 6.4 Romano-British, medieval and post-medieval pottery by Paul Blinkhorn
    - 6.5 Clay tobacco-pipe by Tora Hylton
  - 7 THE FAUNAL AND CHARRED PLANT REMAINS
    - 7.1 The animal bone by Adam Reid
    - 7.2 The charred plant macrofossils and other remains by Val Fryer
  - 8 DISCUSSION
- BIBLIOGRAPHY

## APPENDIX: CONTEXT

### Tables

Table 1: Quantification of worked flint by context

Table 2: Pottery occurrence by number and weight (in g) per context by fabric type

Table 3: The taxa present from hand collected material

Table 4: Bone from sieved samples

Table 5: Plant macrofossils and other remains

### Figures

Front cover: Development area pre-excavation, looking south-east

Fig 1: Site location

Fig 2: General view of site, looking north-west

Fig 3: General view of site, looking south-east

Fig 4: Magnetometer survey results (4nT range)

Fig 5: Magnetometer survey results (20nT range)

Fig 6: Magnetometer survey interpretation

Fig 7: Unprocessed magnetometer data

Fig 8: Geophysical survey with trench locations overlain

Fig 9: Trench 1 showing general geology of the site, looking north

Fig 10: The excavated trenches

Fig 11: Trench 2, plan and sections

Fig 12: Ditch [206], looking north

Fig 13: Trench 3, Plan and section

Fig 14: Trench 4, Plan and section

Fig 15: Possible cremation burials [407] and [408], looking south-east

Fig 16: Trench 6, Plan and sections

Fig 17: Trench 7, Plan and section

Fig 18: Trench 8, Plan and sections

Fig 19: Ditch [811], looking north-east

Fig 20: Terminal [809], looking west

Fig 21: Ditch [807] overlain by furrow [805], looking north-east

Fig 22: Trench 9, Plan and section

Fig 23: Trench 10, Plan and sections

Fig 24: Ditch [1007], looking north-west

Fig 25: Furrow bases [1011] and [1009], looking south-west

Fig 26: Trench 11, Plan and sections

Fig 27: Trench 11 with excavated features, looking north-east

Fig 28: Ditch [1108], looking north-west

Fig 29: Ditch [1110], looking west

Fig 30: Ditch [1114], looking south-east

# **Geophysical survey and archaeological evaluation at Banbury Road, Bodicote Oxfordshire June 2014**

## **Abstract**

*A geophysical survey and trial trench evaluation was undertaken on land at Banbury Road, Bodicote, Oxfordshire in June 2014. Eleven trenches were targeted on anomalies identified by the geophysical survey. The anomalies comprised a large sub-rectangular ditched enclosure and linear and curvilinear anomalies. A ring ditch was also detected at the northern edge of the survey area. The evaluation confirmed the presence of the anomalies and showed the enclosure ditches to be substantial. Additionally, two potential cremation burials were noted. These features are difficult to characterised to period due to lack of datable artefacts.*

## **1 INTRODUCTION**

MOLA was commissioned by RPS Planning and Development, on behalf of Mr R Bratt, to carry out a detailed magnetometer survey and trial trenching on land at Banbury Road, Bodicote, Oxfordshire (NGR SP 4670 3728, Fig 1) for a pre-determination evaluation.

The works were required in line with *National Planning Policy Framework* (DCLG 2012). The Oxfordshire County Archaeological Officer (advisor to Cherwell District Council) required that the impact of development on heritage assets potentially present on the site be assessed. A Written Scheme of Investigation was produced by RPS Planning and Development for both phases of work (RPS 2014). The works were monitored by Rob Masefield of RPS on behalf of the client and by the Oxfordshire County Archaeological Officer Richard Oram on behalf of the LPA. The archive will be deposited with the Oxford County Museum.

MOLA is an Institute for Archaeologists' (IfA) registered organisation. This document was prepared in accordance with the current best archaeological practice as defined in the Institute for Archaeologists' *Standards and Guidance for an Archaeological Field Evaluation* (IfA 2008) and the procedural document *Management of Research Projects in the Historic Environment (MoRPHE)* (EH 2009).

## **2 BACKGROUND**

### **2.1 Location and topography**

The site occupies a field on the south edge of Bodicote, Oxfordshire to the west of Oxford Road (A4260) (Fig 1). The proposed development area comprises a roughly rectangular block of land of c 3.9 hectares. The proposed development area comprises the southern half of a field, the northern half of which has already been subject to evaluation (Wolfram-Murray 2010). The area is surrounded by agricultural fields to the west and south, with a woodland belt boundary. To the north-east lies Cotefield Farm.



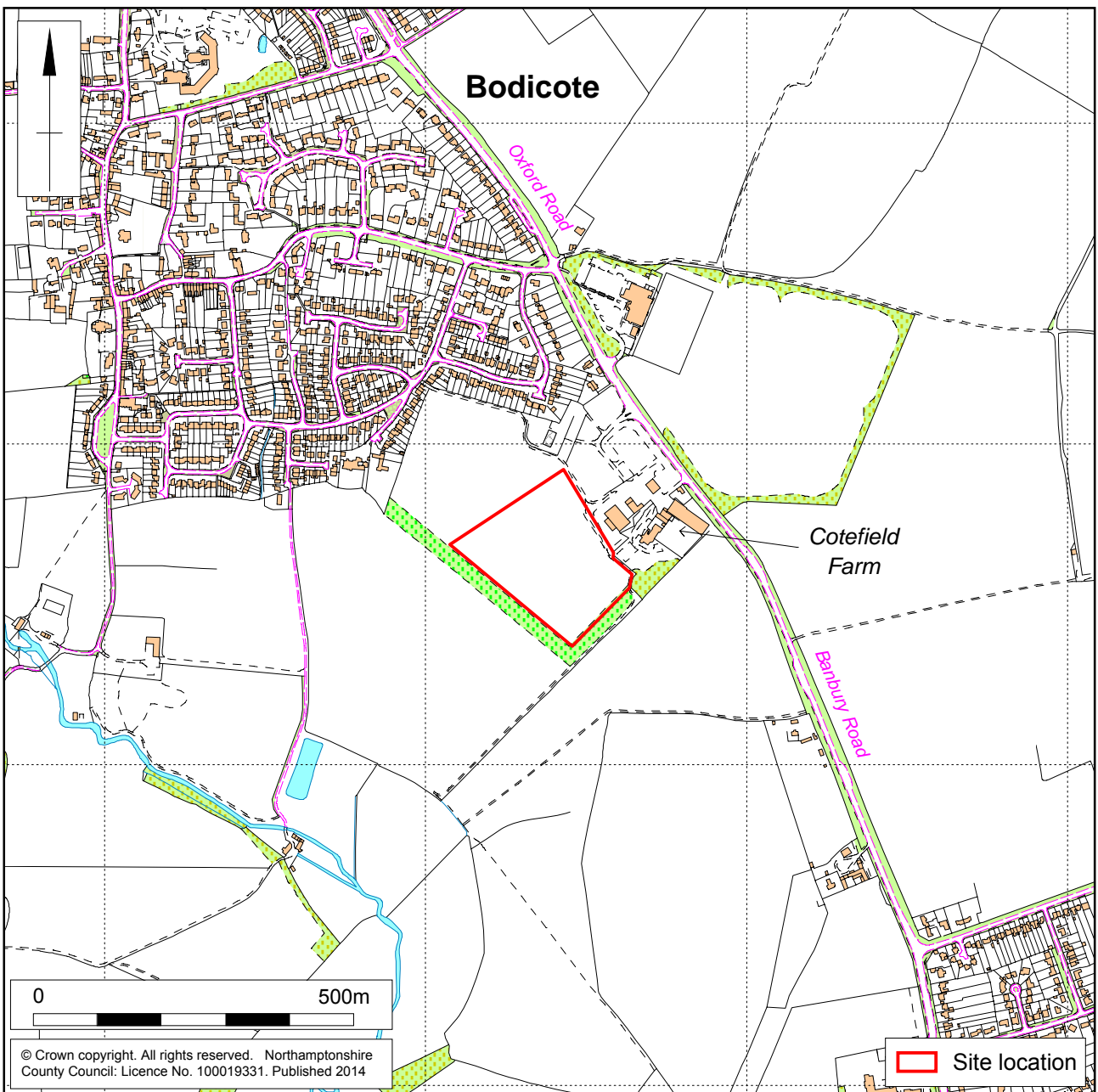
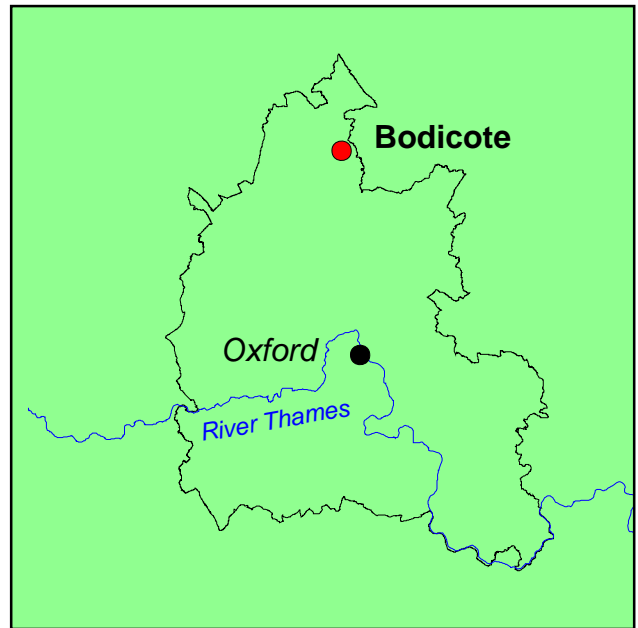

Scale 1:10,000

Site Location Fig 1

The current land-use is arable and historical maps indicated this to have been the case since at least the 19th century. The southern part of the field is largely flat and forms a plateau overlooking a dry valley which runs through the northern part of the site. The land lies between 105m to 113m above Ordnance Datum (Figs 2 and 3).



General view of site, looking north-west Fig 2



General view of site, looking south-east Fig 3

The underlying solid geology was identified as Middle Lias Marlestone with Middle Lias clays, silts and siltstones from the south-west (RPS 2006).

## 2.2 Historical and archaeological background

The historical and archaeological background is summarised in the WSI (RPS 2014).

In the vicinity of the development area a number of sites are recorded in the Oxfordshire Historic Environmental Record (HER). Roman occupation remains are present 200m to the south (HBSMR 1747; SP 4693 3720) and a cursus-like cropmark has been identified from aerial photographs (HBSMR 5700; SP 4733 3718) 600m south-east of Cotefield Farm.

An archaeological evaluation was carried out in October 2010 by Northamptonshire Archaeology (now MOLA) (Wolfram-Murray 2010). The earliest archaeological features uncovered during the trial trenching were two potentially early to middle Neolithic pits. Iron Age activity was identified in two areas in the proposed development area. The concentration of the pottery in the features of both trenches may be settlement related, which is indicated to be late Iron Age by the pottery.

A series of ditches in the central part of the site appear to represent potentially late Iron Age boundary features. They were traced using cropmarks from Google Earth and confirmed through trenching. Although the features included domestic debris, there were few signs of occupational features associated with them.

The 1st edition Ordnance Survey map shows three parallel field boundaries aligned north-east to south-west, possibly indicating a pair of narrow linear closes, which could be the result of early enclosure by agreement. At a right angle, aligned north-west to south-east, was another field boundary, which was depicted up to the 2nd edition Ordnance Survey map.

## 3 OBJECTIVES AND METHODOLOGY

The general aim of the investigations was to establish the character, date and function of any archaeological features and deposits.

Specific research aims for the investigation are based on the background data that exists for the site and include the following:

- Investigation of anomalies identified during the geophysical survey
- Establishing the presence or absence of prehistoric features
- Establishing the presence or absence of Iron Age/Roman features
- Establishing the presence or absence of Saxon settlement features
- Establishing the presence or absence of medieval settlement and landscape features
- Establishing the presence or absence of other archaeological features which inform the history of the landscape of the proposed development site.

### 3.1 Geophysical survey methodology by John Walford

The magnetometer survey was conducted with Bartington Grad 601-2, twin sensor array, vertical component fluxgate gradiometers (Bartington and Chapman 2003). These are standard instruments for archaeological survey and can resolve magnetic variations as slight as 0.1 nanoTesla (nT).

A grid of 30m squares was established across the area to be surveyed. This grid was set out with a tape measure and optical square and was tied in to the Ordnance Survey National Grid by means of a Leica Viva dGPS. The gradiometers were carried at a brisk but steady pace through each grid square, collecting data along 1m spaced traverse lines. Measurements were automatically triggered every 0.25m along the traverses, giving a total of 3600 measurements per square. All fieldwork methods complied with the guidelines issued by English Heritage and by the Institute for Archaeologists (EH 2008; IfA 2011).



Scale 1:2000 (A4)

Magnetometer survey results (4nT range)

Fig 4



Scale 1:2000 (A4)

Magnetometer survey results (20nT range) Fig 5

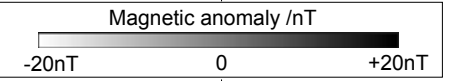

© Crown copyright. All rights reserved. Northamptonshire County Council: Licence No. 100019331. Published 2014

Scale 1:2000 (A4)

Magnetometer survey interpretation

Fig 6

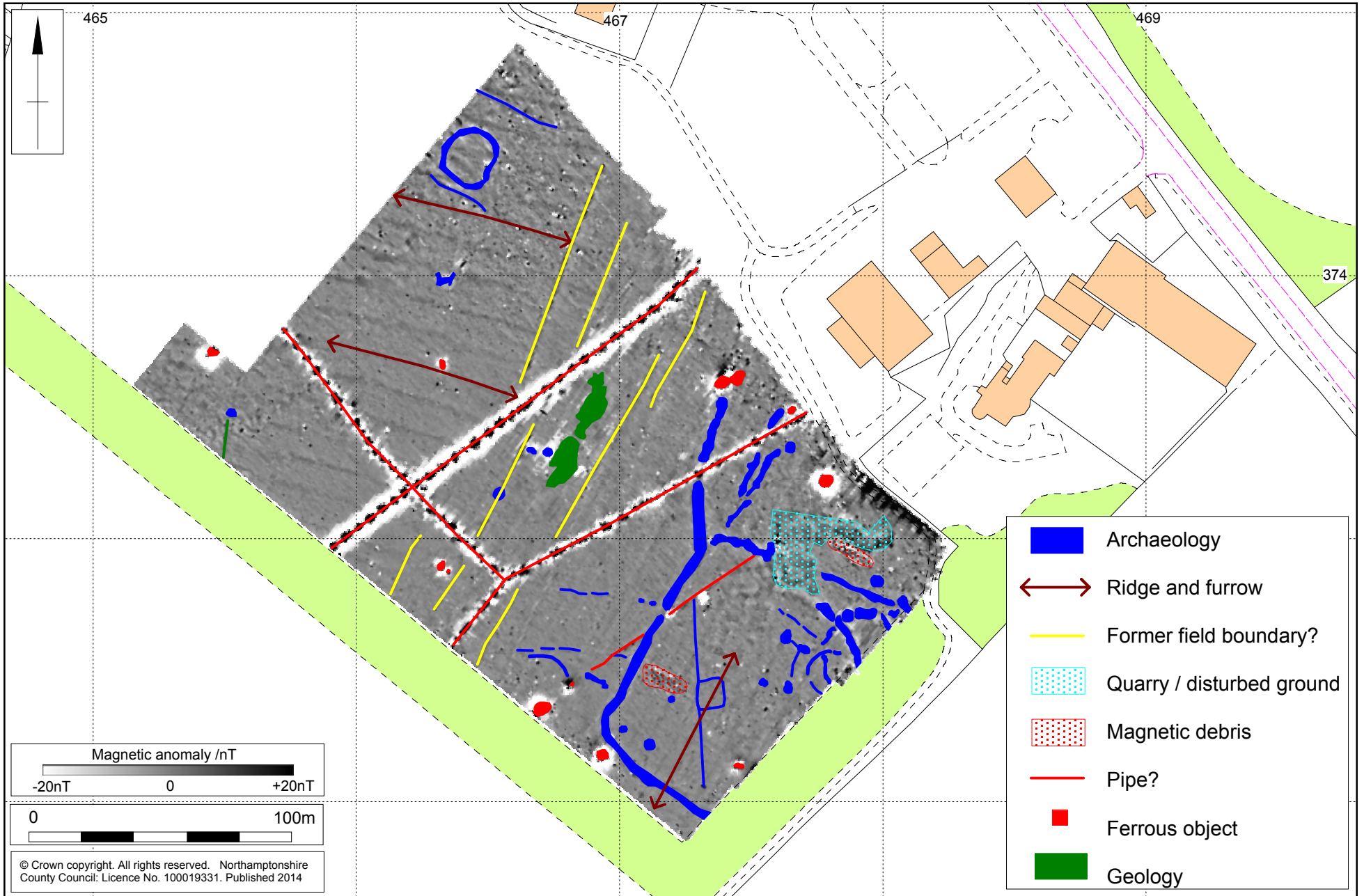

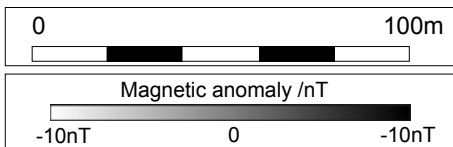

Scale 1:2000

Unprocessed magnetometer data Fig 7

The survey data was processed using Geoplot 3.00v software. Striping, caused by slight mismatches in sensor balance, was removed using the 'Zero Mean Traverse' function and destaggering of the data was performed as necessary. The processed data is presented in this report in the form of two grey-tone plots, at scales of +/- 4nT and +/-20nT black/white. These plots have been scaled, rotated and resampled (georectified) for display against the Ordnance Survey base mapping (Figs 4 and 5). An interpretative overlay is presented in Figure 6 and a plot of the raw survey data is presented in Figure 7.

### **3.2 Trial trench evaluation methodology**

Eleven (11) trial trenches, each 40m long and 1.8m wide, with a total length of 440m were proposed, all but 20m of Trench 5 were excavated. All areas of ground disturbance were accurately surveyed in using Viva 1200 GPS survey equipment and tied into the Ordnance Survey (Fig 8).

Machine excavation was undertaken under the direction of a suitably experienced archaeologist. Trenches were excavated by machine using a toothless ditching bucket 1.8m wide, to reveal archaeological remains or, where absent, undisturbed natural horizons. After archaeological remains were encountered all subsequent examination and excavation was carried out by hand to determine their date and character.

Each trench was cleaned sufficiently to enhance the definition of features. All archaeological features were investigated. All archaeological deposits and artefacts encountered during the course of evaluation were fully recorded. Recording followed standard MOLA procedures (MOLA 2014). All archaeological features were given a separate context number. Deposits were described on pro-forma context sheets to include details of the context, its relationships, interpretation and a checklist of associated finds.

Soil samples were taken from dateable contexts with the potential for the preservation of charcoal and carbonised plant remains. The sampling strategy conformed to English Heritage guidelines (EH 2002).

Archaeological features were planned at a scale of 1:50. Sections through features were drawn at a scale of 1:10 or 1:20 as appropriate. A photographic record was maintained using black and white film supplemented by digital photography. Photographic views of the site were taken prior to excavation and after backfilling. Each trench was photographed, together with views of individual features.

Finds were collected from the individual deposits and appropriately packed and stored in stable conditions, by context. The field data was compiled into a site archive with appropriate cross-referencing. All records were compiled during fieldwork into a comprehensive and fully cross-referenced site archive.

## **4 THE GEOPHYSICAL SURVEY by John Walford**

The survey has identified a group of positive linear anomalies which represent archaeological features extending over much of the south-eastern end of the survey area. The principal element of the site is a large sub-rectangular ditched enclosure which measures c 90m across and extends an unknown distance south-east beyond the limit of the survey area (Fig 6). It has a substantial ditch radiating northwards from its north-western corner, perhaps defining one edge of a second, conjoined enclosure. On the basis of its morphology, the enclosure may be tentatively dated to the Iron Age or Roman period.

Within the easternmost part of the large enclosure there are two positive curvilinear anomalies which may represent intersecting enclosure ditches representing different



phases of activity. To the south-west, a very faint anomaly suggests the possible presence of a small square enclosure, about 8.0m across, and to the immediate west of this there is a fairly tightly defined patch of magnetic noise which may indicate a scatter of ceramic building material or other weakly magnetic debris. Inside the enclosure there are also several small positive anomalies suggestive of pits, whilst outside of the enclosure there are several linear anomalies indicating ditches of unknown date and function.

Part of the northern edge of the main enclosure anomaly is disrupted by an area of broad, amorphous, low amplitude magnetic anomalies suggestive of former quarry pits or other disturbed ground.

Other archaeological remains are present in the northernmost part of the survey area, where the survey has detected a positive annular anomaly, approximately 17m across. This represents a ring ditch or circular enclosure ditch. To its north and south there are positive linear anomalies which may represent other ditches, and about 35m south of the ring ditch there is an irregular positive anomaly which may either represent a large pit or an area of modern disturbance associated with a nearby telegraph pole.

Remnants of medieval or early post-medieval ridge and furrow have been detected in the north-western half of the survey area, where they are represented by regularly spaced positive linear anomalies on parallel west-north-west to east-south-east alignments. Less distinct traces of ridge and furrow have also been detected in the south-east of the area, where the furrows are represented by weakly positive anomalies aligned north-north-east to south-south-west.

A series of positive linear anomalies have been detected across the centre of the survey area, trending north-north-east to south-south-west along the axis of the dry valley. Some of these could represent a western continuation of the ridge and furrow mentioned above, but others may be associated with three closely spaced, tree-lined boundaries depicted in this area on the first edition Ordnance Survey map. In the same area the survey has also detected a thin negative linear anomaly which possibly represents a drain or a service trench, and a large, positive, 'moustache-shaped' anomaly which probably arises from the colluvial deposits at the base of the dry valley.

Two modern pipelines have been detected, each one represented by a very intense linear anomaly with a negative halo. One crosses the field from north-east to south-west, and the other follows a similar alignment but has an arm branching perpendicularly to the north-west. A third pipe is probably represented by a much weaker positive anomaly which runs from north-east to south-west and has several ferrous dipoles along its length. Two of these dipoles correlate with manholes, and the others could possibly represent metal collars or other fittings on an otherwise non-ferrous pipe.

A number of large dipolar anomalies of ferrous origin have been detected in various places across the survey area. Most will represent pieces of modern ferrous debris in the ploughsoil or subsoil but one, in the far west of the area, corresponds to a telegraph pole.

Scale 1:2500 (A4)

Geophysical survey results with overlying trenches

Fig 8



## 5 THE TRIAL TRENCH EVALUATION by Yvonne Wolfram-Murray

### 5.1 General comments

The natural substrate consisted of light yellow-grey clay and blue-yellow silty clay with areas of high ironstone content. In the central trenches, Trenches 3-6 and 11, a layer of grey-brown clay silt colluvium was recorded. The natural or subsoil were overlain by light orange-yellow silty clay subsoil. The topsoil was mid grey-brown clay loam (Fig 9) (see Appendix for details).

Archaeological features were recorded in all trenches except Trenches 1 and 5. Trench 5 was shorted as not to disturb the tree. The trenches were targeted to investigate anomalies noted during the geophysical survey (Fig 8). These included the enclosure ditches in Trenches 4, 6 and 8-10, the ring ditch in Trench 2, linear features in Trenches 4 and 6-11, furrows in Trenches 10 and 11. Additionally two potential cremation burials were observed in Trench 4.



Trench 1 showing general geology of the site, looking north Fig 9

### 5.2 Trench 2

Trench 2, 40m long and aligned north-south, was positioned across a ring ditch. A further 19m of trenching aligned east to west was carried out to confirm the characteristics of the circular enclosure feature shown in the geophysical survey (Figs 8, 10 and 11). Ditch [205] was 0.75m wide and 0.20m deep (Fig 11, section 12). The fills were red-brown silty clay (204) overlain by mid brown silt (203). The ditch is truncated on the western side by a land drain. Pottery recovered from the fill (203) dated to the 13th century.

Ditch [206] was 1.2m wide and 0.42m deep, with a fill of mid red-brown clay silt (207). This was cut by ditch [208], 0.80m wide and 0.50m deep, with a fill of mid red-brown clay silt (209) (Figs 11, section 13, and 12). A pottery sherd of a possible Iron Age/early Roman date was recovered from fill (207).

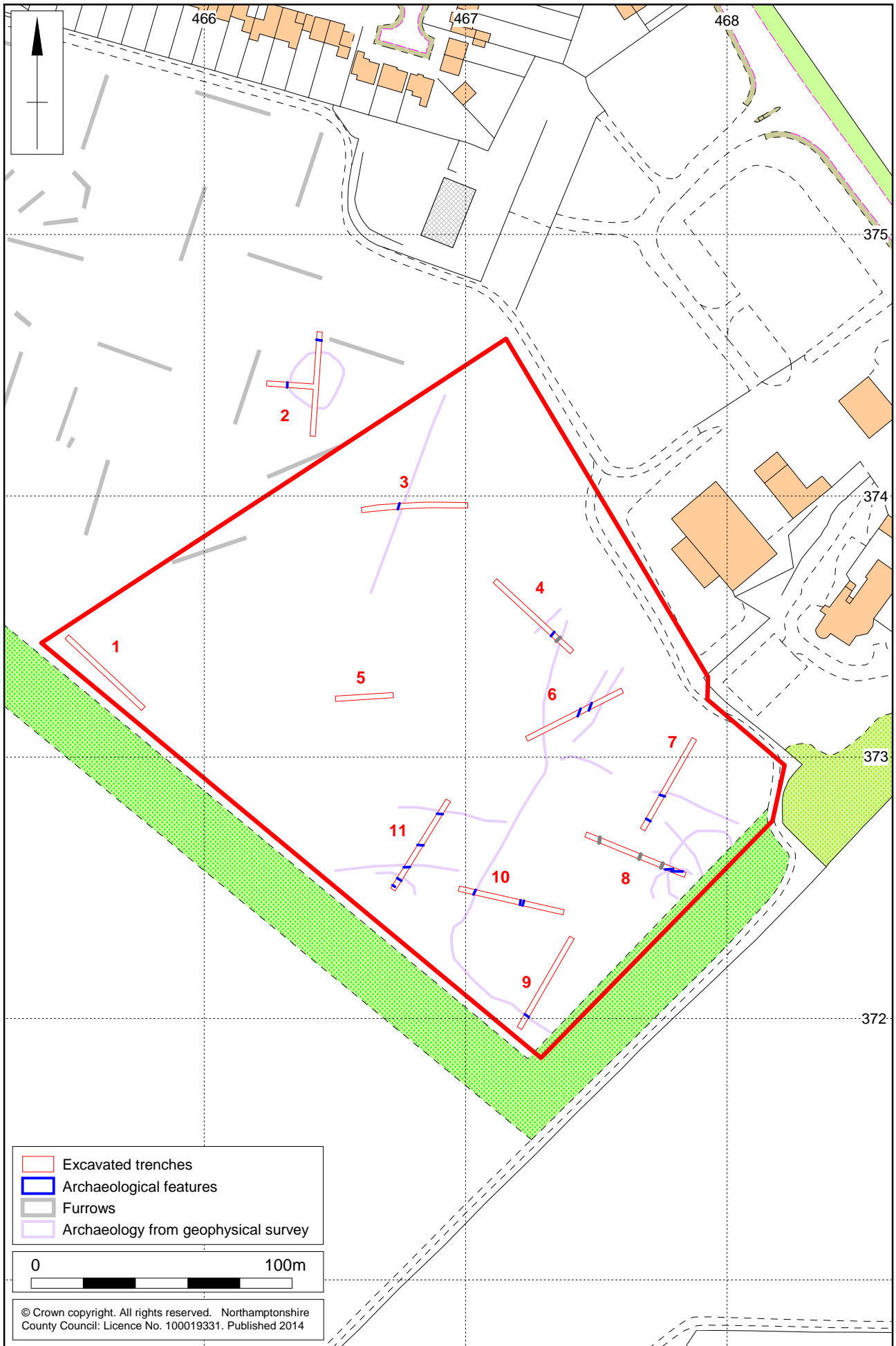

Scale 1:2000 (A4)

The excavated trenches Fig 10



**Section 12**

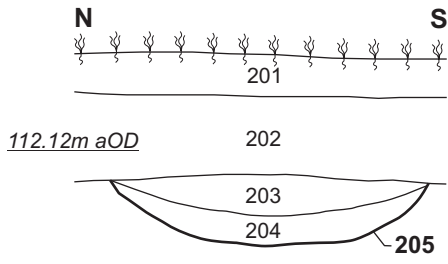

**Section 13**

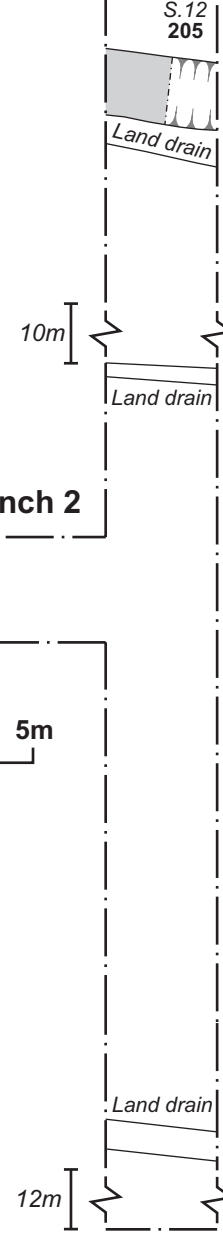
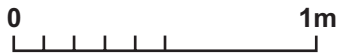
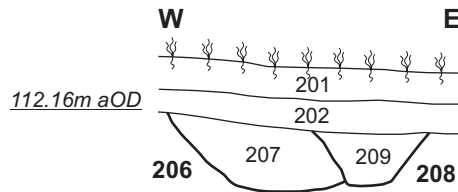

**Trench 2**



Trench 2, looking south



Ditch [206], looking north Fig 12

### 5.3 Trench 3

Trench 3, orientated east to west, was situated over linear anomalies (Figs 8, 13 and 14, section 6). A ditch [306] was uncovered at the location of the anomaly. The ditch was 1.02m wide and 0.12m deep, with a fill of black sandy silt (305). The recovered fragment of a clay-tobacco pipe bowl dated to the late 19th and early 20th century. To the east of the ditch a layer of colluvium was observed comprising mid grey-brown clay silt. Pottery recovered from the colluvium dated to the 16th century.

### 5.4 Trench 4

Trench 4 was aligned south-east to north-west and targeted the enclosure ditch feature [410], which was left unexcavated as it was sampled in Trenches 6, 9 and 10 (Fig 8). Ditch [406], 1.80m to the north-west, was orientated north-east to south-west (Fig 14, section 10). It measured 0.79m wide by 0.23m deep with a fill of dark grey-brown silty loam (405). A fragment of light vesicular fuel ash slag with a vitrified (glassy) surface was recovered along with animal bone fragments.

Two possible cremation burials (Fig 15) were located 1.20m south of ditch [406]. The features were circular in shape and pit [407] was 0.32m in diameter and pit [408] was 0.24m in diameter. Both features had dark fills with charcoal and small flecks of white, burnt bone were noted in feature [407]. They were left *in situ*.

### Section 6



112.00m aOD



### Trench 3

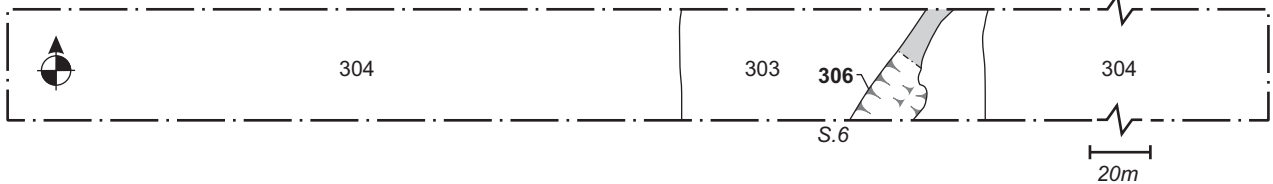

Ditch [306] in Trench 3, looking south

### Section 10

NW SE

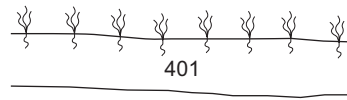

402

112.50m aOD

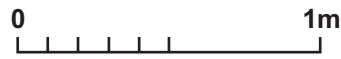

### Trench 4

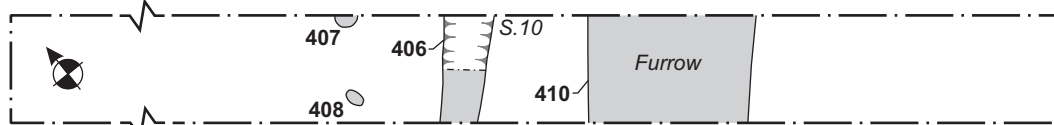

23m



Ditch [406], looking north-east





Possible cremation burials [407] and [408], looking south-east Fig 15

### 5.5 Trench 6

Trench 6 was aligned north-east to south-west and situated over the enclosure ditch and two ditch-like anomalies (Fig 8). The enclosure ditch [611] was machine excavated to a depth of c 1.0m. It was backfilled due to unstable sides. The fill comprised mid brown-orange silt (610), containing a small lump of fired clay, worked flint and two 18th-century clay tobacco-pipe stem fragments (likely to be intrusive possibly from a furrow).

The two parallel linear anomalies appearing in the north-western end of the trench related to ditch [605] and ditches [609] and [607] (Figs 8 and 16, sections 3 and 5). Ditch [605] was 0.93m wide and 0.37m deep with mid brown-red sandy clay (604). Ditch [609] 3.50m south, measured 0.42m wide and 0.38m deep, and was cut by ditch [607]. Both ditches were filled with mid brown-red sandy clays (608) and (606).

### 5.6 Trench 7

Trench 7 was aligned north-east by south-west and targeted the enclosure ditch and pits/areas of disturbances (Fig 8). The enclosure ditch could not be clearly seen due to disturbances, at its location a feature [707] was excavated, c 1.0m deep and 0.10m wide, filled with dark orange-brown silty clay (708) and containing a mid 11th-century pottery sherd. A ditch [705] near the centre of the trench, north-west by south-east, aligned was 0.63m wide and 0.11m deep, and filled with mid yellow-brown clay silt (704) (Figs 17, section 14). The north-eastern part of the trench was covered in dark orange-brown sandy clay layer, which contained brick.

### 5.7 Trench 8

Trench 8 was aligned north-west to south-east and positioned to investigate linear and circular anomalies at the north-eastern edge of the development area (Fig 8). At this location a shallow ditch [811] and a ditch terminal [809] cut by ditch [807] were recorded. The shallow and narrow ditch [811], 0.32m wide and 0.04m deep, was filled by dark grey-brown silty clay (810) with frequent charcoal inclusions, a piece of fired clay and animal bone (Figs 18, section 9, and 19). It became ephemeral to the west.

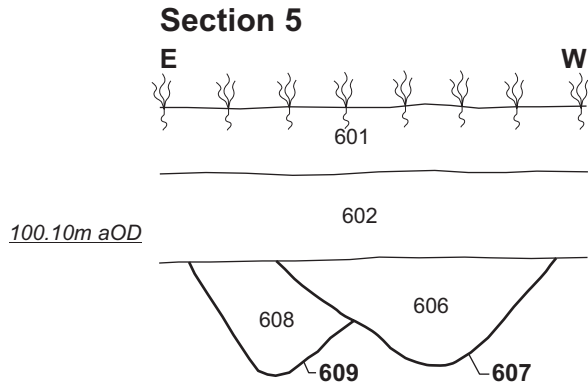
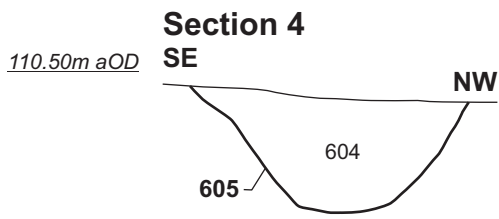

**Trench 6**

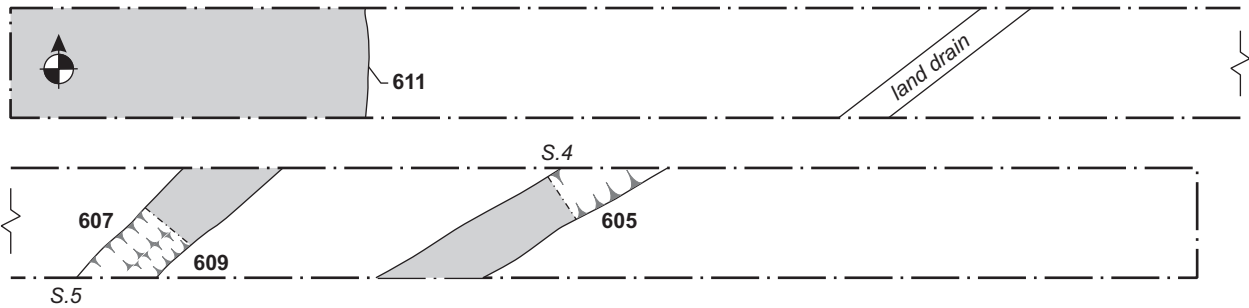

Ditches [607] and [609], looking south-west

**Section 4**

SW NE

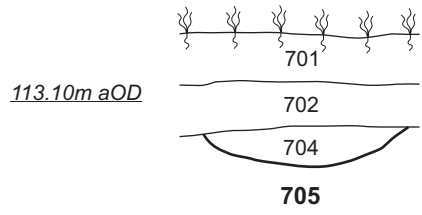

**Trench 7**

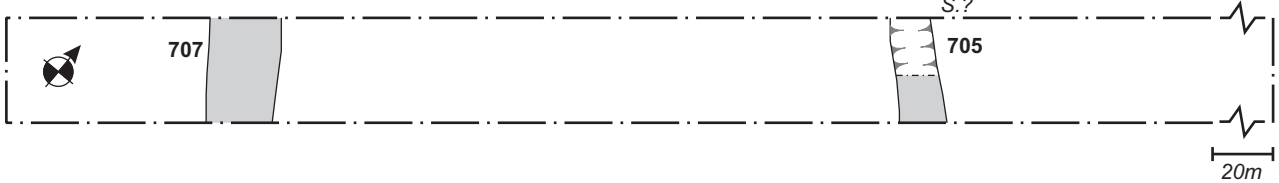

Ditch [705], looking north-west

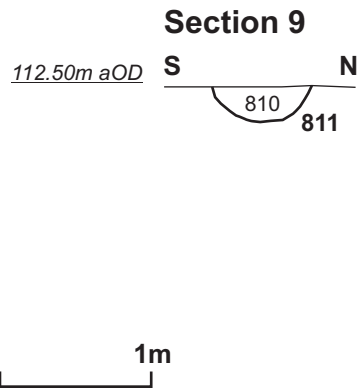
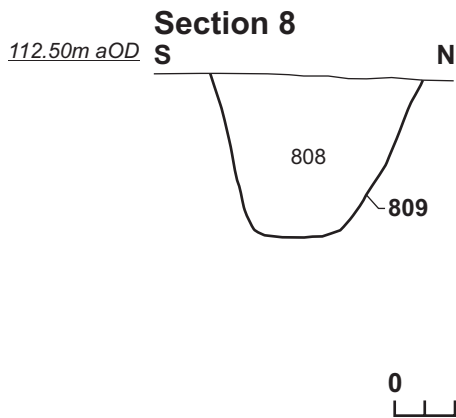
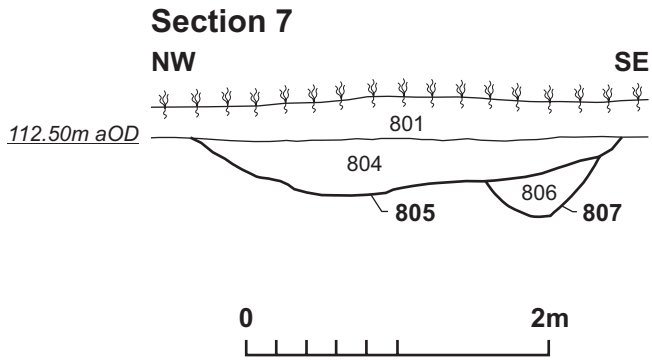

**Trench 8**

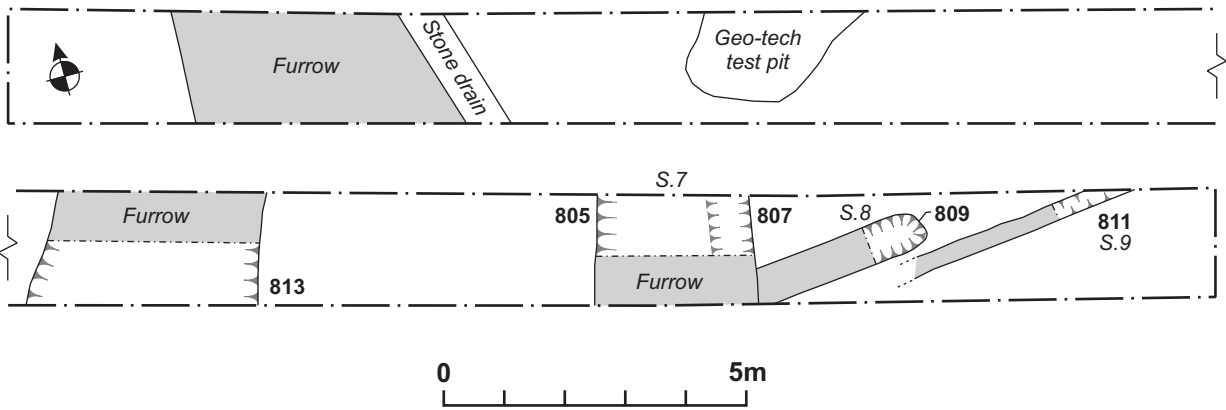



Ditch terminal [809], 0.66m wide and 0.52m deep, was aligned east to west (Figs 18, section 8, and 20) with dark grey-brown silty clay fill (808). This was cut by ditch [807], 0.87m wide and 0.23m deep and aligned north-east to south-west. The fill was dark grey-brown silty clay (806), containing animal bone. Ditch [807] was truncated and covered by furrow [805], 1.64m wide and 0.16m deep, with the light grey-brown clay silt fill containing a 16th-century pottery sherd (Figs 18, section 7, and 21).

Two further furrows were noted in the trench with similar dimensions.



Ditch [811], looking north-east Fig 19



Terminal [809], looking west Fig 20



Ditch [807] overlain by furrow [805], looking north-east Fig 21

### 5.8 Trench 9

Trench 9 was aligned south-west to north-east and positioned over the enclosure ditch in southern corner of the development area (Fig 8). The enclosure ditch [907] was only excavated to a depth of 1.0m due to health and safety, it was 4.72m wide (Figs 22, section 11). On the eastern side was possible evidence of slumping with fills (906) and (905), which were mid brown-grey sandy clay and light yellow-brown clay sand respectively. The ditch possibly silted up with mid brown-grey silty clay (904). No finds were recovered from the ditch section.

### 5.9 Trench 10

Trench 10, aligned north-west to south-east, and targeted the enclosure ditch (Fig 8). At the location of the anomaly a ditch [1007] was excavated, 3.50m wide but excavation at of 1.60m deep due to health and safety (Figs 23, section 1, and 24). The fills of silty sands (1006) and (1005) with a sandy clay upper fill (1004) indicate silting of the ditch.

Near the centre of the trench were two parallel ditches 0.30m apart (Figs 23, section 2, and 25). Ditch [1009] was 0.60m wide and 0.10m deep, and ditch [1011] was 0.35m wide and 0.09m deep. The mid brown sandy clay fills (1008) and (1010) were devoid of finds.

A possible tree hole was recorded towards the centre of the trench (Fig 23, section 3).



### Section 11

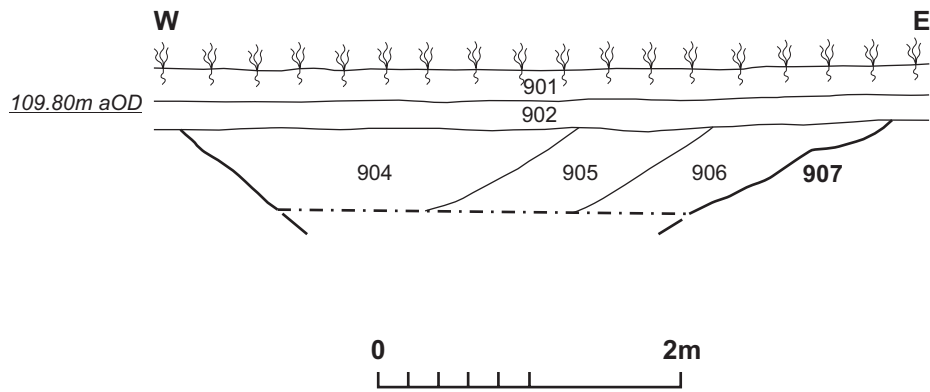

### Trench 9

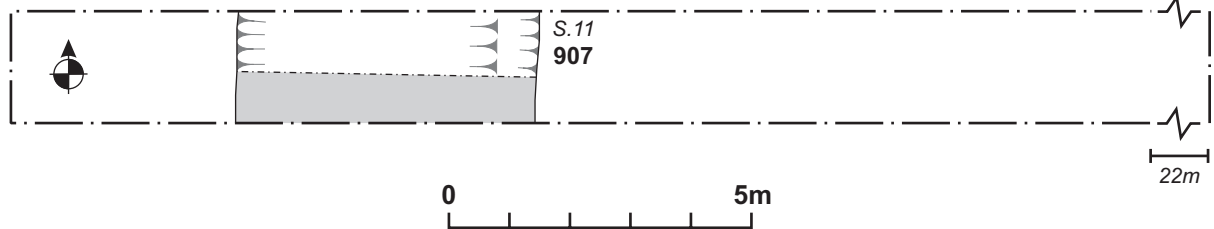

Trench 9, with ditch [907], looking east

**Section 1**  
SE

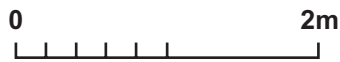
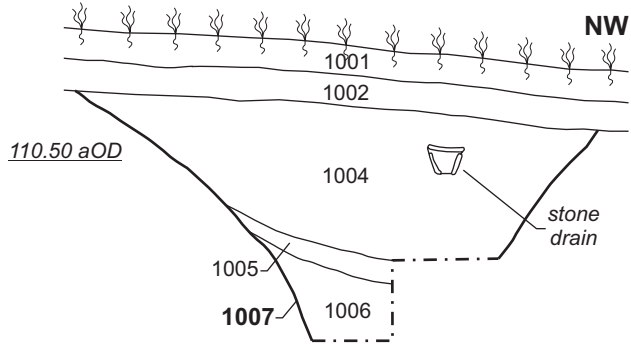

**Section 2**

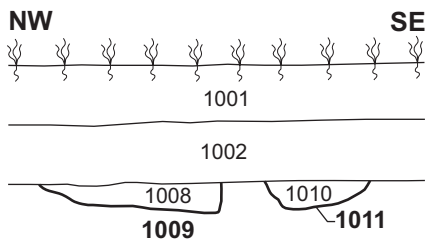

112.80m aOD



**Section 3**

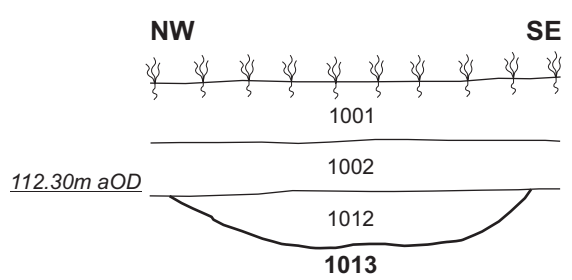

112.30m aOD

**Trench 10**

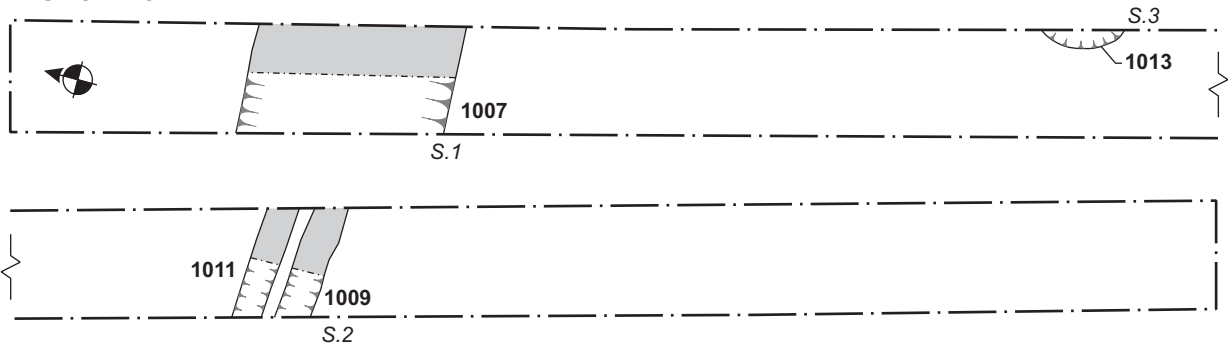

Scales, sections 1:25 & 1:50, plan 1:125

Trench 10, plan and sections Fig 23





Ditch [1007], looking north-west Fig 24



Furrow bases [1011] and [1009], looking south-west Fig 25

### 5.10 Trench 11

Trench 11 was aligned south-west to north-east and positioned to investigate geophysical anomalies at both ends of the trench (Fig 8). At the south-western end of the trench the terminal of a shallow ditch [1106] was recorded, 0.45m wide and 0.08m deep, filled with mid brown silty clay (Figs 26, section 14, and 27). Ditch [1108] was orientated north-west to south-east and 1.06m wide and 0.18m deep. The fill was mid brown silty clay (1107) (Figs 26, section 15, and 28). Ditch [1110], 0.70m wide and 0.15m deep, was east to west orientated and filled with mid brown silty clay (1109) (Figs 26, section 16, and 29). No finds were recovered and very little charcoal flecking was noted.

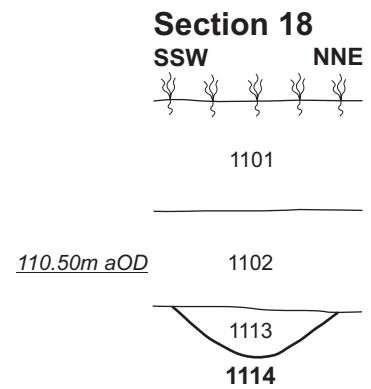
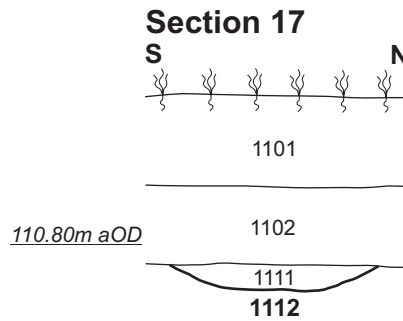
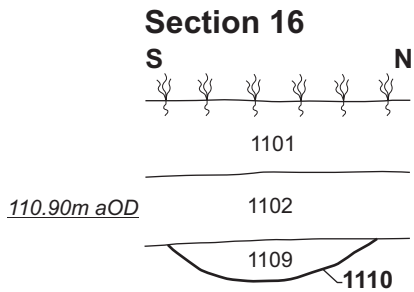
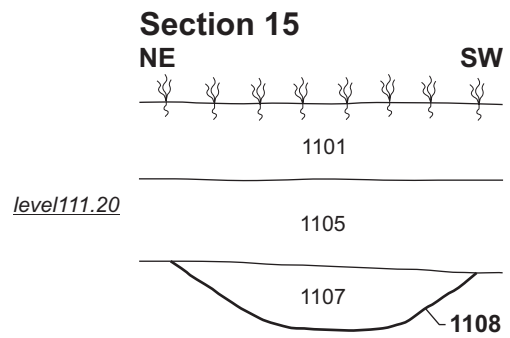
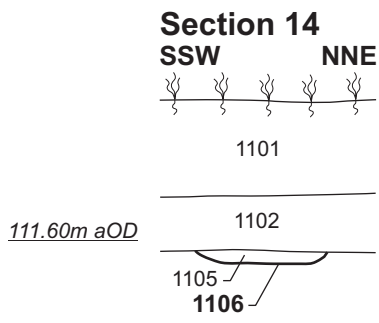

**Trench 11**

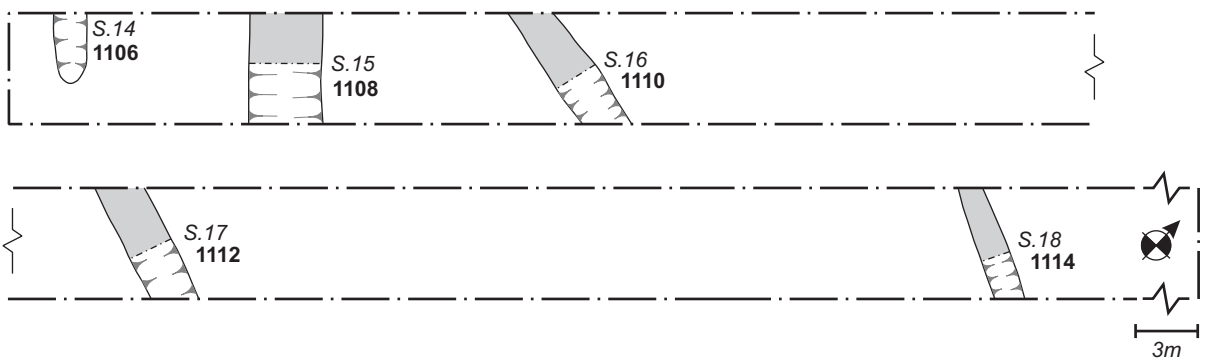

Near the centre was a shallow ditch [1112], which was 0.70m wide and 0.07m deep filled with mid orange-brown silty clay (1111). At the location of the north-eastern anomaly ditch [1114] was excavated. It was 0.49m wide and 0.17m deep with a fill mid brown silty clay (1113) (Figs 26, section 18, and 30). No finds were recovered. Colluvium (1104) was present towards the north-eastern end of the layer, Romano-British pottery sherds and worked flint were recovered from this layer.



Trench 11 with excavated features, looking north-east Fig 27



Ditch [1108], looking north-west Fig 28





Ditch [1110], looking west Fig 29



Ditch [1114], looking south-east Fig 30

## 6 THE FINDS

### 6.1 Worked flint by Yvonne Wolfram-Murray

In total 56 pieces of worked flint were recovered as surface finds, and as residual finds from Iron Age contexts, comprising two cores, 45 flakes, and nine blade (summaries in Table 1).

*Table 1: Quantification of worked flint by context*

Context/ Feature type	Flake	Blade	Core	Total
	Whole/Fragment	Whole/Fragment		
101/Topsoil	2/1	-	-	3
201/Topsoil	1/1	-	-	2
207/Ditch 206	1/0	-	-	1
301/Topsoil	0/2 ( 1Burnt)	-	1	3
302/Subsoil	0/1 (1 Burnt)	-	-	1
303/Colluvium	0/2	0/1	-	3
305/Ditch 306	0/1	-	-	1
401/Topsoil	2/0	-	-	2
402/Subsoil	0/1	-	-	1
601/Topsoil	2/5	2/0	1	10
610/Ditch 611	-	0/1	-	1
701/Topsoil	1/0	2/0	-	3
801/Topsoil	2/3	-	-	5
901/Topsoil	0/1	-	-	1
1001/Topsoil	3/1	-	-	4
1004/Ditch 12007	1/1	-	-	2
1101/Topsoil	3/5 (2 Burnt)	1/2	-	11
1104/Colluvium	1/1	-	-	2
<b>Total</b>	<b>19/26</b>	<b>5/4</b>	<b>2</b>	<b>56</b>

The condition of the assemblage is very poor. The flint shows very heavy post-depositional damage in the form of frequent irregular nicks to the edges. This was especially the case for the artefacts collected from the ploughsoil and made the recognition of retouch and utilisation difficult. Slight milky discolouration of the surface was present occasionally in the assemblage.

The raw material comprises a vitreous flint of light to dark coloured greys and browns. There is also the component of a more granular grey 'chert'-like flint of white and light grey colours. The cortex was typically light and mid brown in colour with a generally smooth, rolled surface. The raw material is likely to have derived from fluvial and glacial sources.

Two flake cores were recovered, which had multiple striking platforms and were relatively small in size. The majority of the collected material comprised waste flakes and blades, dominated by flakes. The assemblage comprised 45 flakes, of which 26 were broken and four showed signs of accidental heat damage, and nine blades, of which four were broken.

The technological characteristics of the assemblage suggest a broadly Neolithic to early Bronze Age; this is comparable to the assemblage recovered in the northern part of the field (in Wolfram-Murray 2010). However, the assemblage from the

current evaluation was recovered mostly from the ploughsoil with very little recovered from features.

## 6.2 Prehistoric pottery and fired clay by Andy Chapman

From the fill (207) of ditch [206] there is a single body sherd, 8mm thick, weighing 10g. The fabric contains grog and angular mineral inclusions. The core is orange and the surfaces are light grey-brown. The inclusions project from the inner surface, but the outer surface is smooth. Trial trenching of an adjacent site produced Iron Age pottery containing crushed shell and late Iron Age/early Roman pottery containing grog (Chapman 2010). The date of this sherd is uncertain, but given the quality of the potting and the fabric a late Iron Age/early Roman date seems most likely.

The fill (810) of ditch [811] produced a small lump, weighing 3g, of hard fired clay, brown to grey in colour; the fill (610) of ditch [611] produced a small lump, weighing 7g, of soft light brown fired clay; and the fill (1004) of ditch [1007] produced two small lumps, weighing 6g, of soft fired clay, orange in colour.

## 6.3 Slag by Andy Chapman

From the fill (405) of ditch [406] there is a single fragment, weighing 25g, of light vesicular fuel ash slag with a vitrified (glassy) surface. This has come from some high temperature process, but does not appear to derive from ironworking.

## 6.4 Romano-British, medieval and post-medieval pottery by Paul Blinkhorn

The pottery assemblage comprised 11 sherds with a total weight of 153g. It comprised a mixture of Romano-British, medieval and post-medieval wares, and was recorded utilizing the coding system and chronology of the Oxfordshire County type-series (Mellor 1984; 1994), as follows:

**R30: Sandy Greyware** (1st-4th century), 2 sherds, 7g  
**OXBF: North-East Wiltshire Ware** (AD1050-1400), 1 sherd, 4g  
**OXAM: Brill/Boarstall ware** (AD1200-1600), 1 sherd, 5g  
**OXBX: Late Medieval Brill/Boarstall Ware** (15th-early 17th centuries) 3 sherds, 35g  
**OXBEW: Manganese Glazed ware** (18th century), 4 sherds, 100g  
**WHEW: Mass-produced white earthenwares** (19th-20th centuries), 1 sherds, 2g

The pottery occurrence by number and weight of sherds per context by fabric type is shown in Table 2. Each date should be regarded as a *terminus post quem*. The fabric types are all well-known in the region, and most are in fairly good condition, other than the Romano-British sherds, which are somewhat abraded and could possibly be residual.

Table 2: Pottery occurrence by number and weight (in g) per context by fabric type

Feature fabric	202 No/ Wt (g)	303 No/ Wt (g)	305 No/ Wt (g)	706 No/ Wt (g)	708 No/ Wt (g)	801 No/ Wt (g)	804 No/ Wt (g)	1104 No/ Wt (g)	Total No/ Wt (g)
<b>R30</b>	-	-	-	-	-	-	-	2/7	2/7
<b>OXBF</b>	-	-	-	-	1/4	-	-	-	1/4
<b>OXAM</b>	1/5	-	-	-	-	-	-	-	1/5
<b>OXBX</b>	-	2/18	-	-	-	-	1/17	-	3/35
<b>OXBEW</b>	-	-	-	1/37	-	3/63	-	-	4/100
<b>WHEW</b>	-	-	1/2	-	-	-	-	-	1/2
<b>Date (century)</b>	13th	16th	19th	18th	Mid 11th	18th	16th	R-B	-

## 6.5 Clay tobacco-pipe by Tora Hylton

Three pieces of tobacco-pipe were recovered during the evaluation. They include a bowl fragment and two stems. The bowl was recovered from field boundary ditch [306] (Trench 3), and although incomplete, it is possible to determine that it represents part of a large pipe bowl decorated with a vestige of a foliate motif, not dissimilar to examples illustrated by Oswald (1975, Fig 17, 6a, b) and Moore (1980, Fig 13, 55), which date to the late 19th and early 20th centuries.

The stem fragments are exceedingly abraded and they measure up to 23mm in length, they were recovered from the fill of a field boundary [611] in Trench 6. The stems have bores measuring 7/64's of an inch, suggesting an 18th century date for the fragments.

## 7 THE FAUNAL AND CHARRED PLANT REMAINS

### 7.1 The animal bone by Adam Reid

#### *Introduction*

A total of 350g of animal bone was collected by hand from four different contexts during the course of excavation and a further 32g of bone was recovered from two wet-sieved samples. This material was assessed to determine the level of preservation, the taxa present and to inform on the potential for further work.

#### *Method*

All material had been washed prior to analysis. Identifiable bones were noted, and were examined for signs of butchery and the state of epiphyseal fusion. Identifications took place without access to a reference collection and were aided by Hillson (1992) and France (2009). Specimens that could not be positively identified were attributed, where possible, to categories including Large Mammal (Cattle, Horse), Medium Mammal (Sheep/Goat, Pig, Dog) and Small Mammal (Rodent, Shrew).

#### *Preservation*

The state of preservation of the material was good in several cases, although the assemblage has been subjected to a large degree of fragmentation. Some specimens demonstrate signs of moderate surface abrasion and no evidence of butchery or gnawing was observed.

#### *Identification and Quantification*

The highly fragmented nature of the assemblage made identifications difficult, and 31 fragments (78%) of the hand collected material was indeterminate (Table 3). The majority of the hand collected material (26 fragments) was recovered from context (1004) the upper fill of enclosure ditch [1007]. Only two of these fragments were identifiable - a cattle humerus and a cattle metacarpal. None of the material recovered from sieving was clearly identifiable (Table 4), although the presence of two microfaunal specimens was noted from context (808), the fill of ditch terminal [809].

Table 3: The taxa present from hand collected material

Context/ Feature/ Type	Cattle Bos	Sheep/goat Ovicaprid	Pig Sus	Indeterminate	Total
405/406/Ditch	-	-	1 ( <i>Ulna</i> )	1	2
806/807/Ditch	-	-	2 ( <i>Mandible, Premolar</i> )	2	4
810/ 811/Ditch	-	4 ( <i>Mandible, Molar x 2, Premolar</i> )	-	4	8
1004/1007/Ditch	2 ( <i>Humerus, Metacarpal</i> )	-	-	24	26
<b>Total</b>	<b>2</b>	<b>4</b>	<b>3</b>	<b>31</b>	<b>40</b>

Table 4: Bone from sieved samples

Sample	Context/ Feature/ Type	Weight (g)	Medium Mammal	Small Mammal	Indeterminate	Total
2	810/811/Ditch	31	3	-	59	62
3	808/809/Ditch Terminal	1	-	2	10	12
<b>Total</b>		<b>32</b>	<b>2</b>	<b>2</b>	<b>69</b>	<b>74</b>

### ***Aging and metrical data***

A sheep mandible was recovered from context (810) – the single fill of ditch [811]. The specimen possessed a cheek row of five erupted teeth in a moderate state of wear, suggesting that the animal reached full maturity before death. No metrical data was available due to the fragmented nature of the assemblage.

### ***Conclusion***

The small nature of the assemblage makes it difficult to draw any conclusions, other than to suggest that the main domestic taxa were utilised at the site. The results are similar to those previously reported for an evaluation recently undertaken in the same area (Deighton 2010). The state of preservation of the bone was generally good and the presence of identifiable material from several of the excavated features indicates the possibility for future faunal analysis, should further work take place.

## **7.2 The charred plant macrofossils and other remains by Val Fryer**

### ***Introduction and method statement***

Samples for the retrieval of plant macrofossil assemblages were taken from the enclosure ditch (sample 1) and from an associated ring ditch (samples 2 and 3), and three were submitted for assessment.

The samples were bulk floated by MOLA Northampton and the flots were collected in a 300 micron mesh sieve. The dried flots were scanned under a binocular microscope at magnifications up to x 16 and the plant macrofossils and other remains noted are listed in Table 5. Nomenclature within the table follows Stace (1997). All plant remains were charred. Modern seeds, arthropod remain and leaf fragments were also recorded.



Table 5: Plant macrofossils and other remains

Sample No.	1	2	3
Context no.	1004	810	808
Feature No.	1005	811	809
<b>Cereals</b>			
<i>Hordeum</i> sp. (grains)	-	x	xcf
<i>Triticum</i> sp. (grains)	-	x	x
(rachis internode)	-	x	-
<i>T. aestivum/compactum</i> type (rachis nodes)	-	x	-
Cereal indet. (grains)	-	x	xfg
<b>Herbs</b>			
<i>Bromus</i> sp.	-	-	xcf
Caryophyllaceae indet.	-	x	-
Chenopodiaceae indet.	-	xx	-
Fabaceae indet.	-	x	-
<i>Fallopia convolvulus</i> (L.)A.Love	-	-	x
<i>Medicago/Trifolium/Lotus</i> sp.	-	xcf	x
Small Poaceae indet.	-	xx	x
Polygonaceae indet.	-	x	x
<i>Rumex</i> sp.	-	x	-
<i>Stellaria media</i> (L.)Vill	-	x	-
<b>Other plant macrofossils</b>			
Charcoal <2mm	xxx	xx	xxx
Charcoal >2mm	x	x	x
Charcoal >5mm	-	-	x
Charred root/stem	x	x	x
Indet. seeds	x	xx	x
<b>Other remains</b>			
Black porous 'cokey' material	x	-	x
Black tarry material	-	x	x
Bone	x	-	x
Burnt/fired clay	-	x	-
Small coal frag.	-	-	x
Small mammal/amphibian bone	-	-	xpmc
<b>Sample volume (litres)</b>	<b>40</b>	<b>10</b>	<b>40</b>
<b>Volume of flot (litres)</b>	<b>&lt;0.1</b>	<b>&lt;0.1</b>	<b>&lt;0.1</b>
<b>% flot sorted</b>	<b>100%</b>	<b>100%</b>	<b>100%</b>

x = 1 – 10 specimens    xx = 11 – 50 specimens    xxx = 51 – 100 specimens  
 cf = compare    fg = fragment    pmc = probable modern contaminant

## Results

All three assemblages are small (i.e. <0.1 litres in volume) and very limited in composition. However, cereal grains/chaff and seeds of common weeds are recorded at a low to moderate density within the assemblages from samples 2 (ditch [811]) and 3 (ditch [809]). Preservation is moderately good, although some grains and seeds are puffed and distorted (probably as a result of exposure to high temperatures during combustion) and other macrofossils are fragmentary.

Barley (*Hordeum* sp.) and wheat (*Triticum* sp.) grains are recorded along with a small number of cereals which are too poorly preserved for close identification. The wheat grains all appear to be of a short, rounded hexaploid type form, and bread wheat (*T. aestivum/compactum*) type rachis nodes are present within the assemblage from sample 2. The same assemblage also contains what appears to be a severely abraded glumed wheat rachis internode but, perhaps unusually for a site of supposed Iron Age date, other glumed wheat chaff is entirely absent.

Seeds of common segetal weeds are also recorded within the assemblages from samples 2 and 3. Taxa noted include brome (*Bromus* sp.), small legumes (Fabaceae), black bindweed (*Fallopia convolvulus*), medick/clover/trefoil (*Medicago/Trifolium/Lotus* sp.), small grasses (Poaceae), dock (*Rumex* sp.) and chickweed (*Stellaria media*). Charcoal/charred wood fragments and small pieces of charred root or stem are present within all three assemblages.

Other remains are very scarce, but do include fragments of black porous and tarry material (all of which are probably derived from the high temperature combustion of organic remains including cereal grains), small pieces of heavily abraded bone and occasional fragments of burnt or fired clay.

### **Conclusions and recommendations for further work**

In summary, the assemblage from enclosure ditch [1005] (sample 1) is particularly sparse, almost certainly indicating that is primarily derived from scattered or wind-dispersed refuse which was accidentally incorporated within the ditch fill. The assemblages from the features associated with the ring ditch at the eastern corner of the enclosure are slightly more substantial, although even here, the density of material recovered is low. The composition of the assemblage from sample 2 is consistent with material derived from either an agricultural or domestic context, with the latter possibly being marginally more likely. The cereals may well have been accidentally charred during culinary preparation, whilst the slightly higher density of grass fruits could be indicative of burnt flooring or bedding materials. It would appear that such detritus was frequently cleared from the interior of structures (possibly as a means of preventing accidental fires) and subsequently incorporated within the fills of any nearby open feature. Similar material may also be present within the assemblage from sample 3, although at a far lower density.

As none of the assemblages contain a sufficient density of material for quantification (i.e. 100+ specimens), no further analysis is recommended. However, a summary of this assessment should be included within any publication of data from the site.

## **8 DISCUSSION**

The geophysical survey identified a number of anomalies, concentrating in the south-eastern end of the development area, which the archaeological evaluation confirmed to be archaeological in nature.

Early prehistoric activity was only evident through 56 pieces of worked flint dating to broadly to the Neolithic to early Bronze Age. The majority were recovered as surface finds with a few as residual finds from Iron Age and post-medieval contexts. Two early to middle Neolithic pits were uncovered in the northern part of the field in previous trial trenching (Wolframm-Murray 2010); no further pits were uncovered during the present trial trenching.

In the centre of the northern border of the field the geophysical survey identified a circular anomaly. Initial investigation did not reveal the feature due to the overlying furrows, further trenching revealed a ditch [206] with a possible late Iron Age pottery sherd. The character of the ring ditch and lack of central feature is atypical of an

earlier prehistoric (Neolithic or Bronze Age) funerary monument. This is confirmed by the presence of a sherd of Iron Age pottery. Conversely, the very low quantity of finds is not suggestive of a domestic use for the enclosure, whilst the slightly ovoid form would not suggest an eaves-drip function for a typical 'roundhouse' as is suggested for the ring-gully defined Iron Age features from the evaluation to the immediate north-west (Wolframm-Murray 2010). On balance a function as a small stock enclosure associated with the Iron Age settlement zone to the north-west seems most likely.

The geophysical survey revealed substantial rectangular enclosure and associated boundary within the southern part of the field flanking the south side of the dry valley. The survey suggests continues into the neighbouring field. The sampled ditch and associated boundary sections were substantial, measuring between 3.50m and 4.72m in width, and in excess of 1.60m in depth. Full depth could not be investigated in the scope of trial trenching due to health and safety. No direct dating evidence was recovered from the excavations (intrusive post-medieval material was present in one section) and the sections were generally sparse in inclusions of any type. The morphology of the enclosure suggests a probable Iron Age/early Roman date. There is both Iron Age and Roman activity in the vicinity to the north-west and south-east respectively. At present the simplest interpretation of the large enclosure, based upon the paucity of domestic material or clear internal domestic buildings, is use as a stock enclosure used for confining a substantial herd. The presence of cattle and sheep bone is of interest in this context although the very substantial scale of the ditches is somewhat unusual for such enclosures in the Midlands.

The sampling of the area of curvilinear anomalies noted in the eastern corner of the enclosure in the geophysical survey revealed the presence of three ditches. The shallow ditch [811] was the only ditch to include any substantial amount of inclusions. The charred plant analysis indicated it was possibly derived from a domestic context. The fill also included fired clay fragments; however, no dating evidence was recovered. The area may represent two intersecting phases of curvilinear ditches.

No evidence of the possible small square enclosure or the pits potentially identified during the geophysical survey was found during the evaluation within the enclosure.

Ditches identified outside of the enclosure during the geophysical survey were also recorded. Trench 11 found evidence of the possible curvilinear anomaly at its south-western end. Like with the other ditches identified in the trench they were all without finds or inclusions. The two parallel ditches in Trench 6 were undated and may be contemporary with the enclosure as the ditch in Trench 4. These may represent fragments of field systems pre- or post-dating the large enclosure and boundary.

Two potential cremation burials were identified in Trench 4; these respected the ditch and may be contemporary.

The geophysical survey identified the presence of two distinct ridge and furrow areas, separated by the dry valley in the centre of the field. The northern set of furrows was north-west to south-east orientated and the southern furrows were north-east to south-west orientated. Possible field boundaries or lines of trees lie between the field systems. The first edition Ordnance Survey map indicates lines of trees, but they are not an exact match. The evaluation excavated the northernmost field boundary which is dated by the clay tobacco-pipe bowl fragments to the late 19th and early 20th centuries.

The landowner, Mr Bratt, said that his father had a ha-ha backfilled in the second half of the 20th century that was in the south-eastern corner of the development area, in front of the large house. The wall of the ha-ha is still in place under the grass at the field edge. The topsoil is much stonier in the area and imported, the area uncovered in Trench 7 included brick.

Services were also identified during the geophysical survey, three crossing the site and one was at a right angle. Care was taken not to disturb these during the trial trenching.

**BIBLIOGRAPHY**

- Chapman, A, 2010 The prehistoric pottery, in Y Wolfram-Murray 2010, 17-19
- Bartington, G, and Chapman, C, 2003 A high-stability fluxgate magnetic gradiometer for shallow geophysical survey applications, *Archaeological Prospection*, **11**, 19-34
- DCLG 2012 *National Planning Policy Framework*, Department Communities and Local Government
- Deighton, K, 2010 The animal bone, in Y Wolfram-Murray 2010, 17-19
- EH 2002 *Environmental Archaeology: A Guide to Theory and Practice for Methods, from sampling to post-excavation*, English Heritage
- EH 2008 *Geophysical Survey in Archaeological Field Evaluation*, English Heritage
- EH 2009 *Management of Research Projects in the Historic Environment: The MoRPHE Project Managers Guide*, English Heritage
- France, D L, 2009 *Human and Nonhuman Bone Identification: A Color Atlas*, Boca Raton: CRC Press
- Hillson, S, 1992 *Mammal Bones and Teeth: An Introductory Guide to Methods of Identification*, London: UCL Institute of Archaeology Publications
- IfA 2008 *Standard and guidance for archaeological field evaluation*, Institute for Archaeologists
- IfA 2011 *The Use of Geophysical Techniques in Archaeological Evaluations, 2nd Edition*, Institute for Archaeologists Technical Paper
- Mellor, M, 1984 *A summary of the key assemblages. A study of pottery, clay pipes, glass and other finds from fourteen pits, dating from the 16th to the 19th century*, in TG Hassall *et al*, Excavations at St Ebbe's, *Oxoniensia*, **49**, 181-219
- Mellor, M, 1994 Oxford Pottery: A Synthesis of middle and late Saxon, medieval and early post-medieval pottery in the Oxford Region, *Oxoniensia*, **59**, 17-217
- MOLA 2014 *Archaeological Fieldwork Manual*, MOLA Northampton
- Moore, W R G, 1980 *Northamptonshire Clay tobacco-pipes and pipemakers*, Northampton Museums and Art Gallery
- Oswald, A, 1975 *Clay pipes for the Archaeologist*, British Archaeological Report **14**
- RPS 2006 *Specification for an archaeological evaluation of land south of blackwood Place & Molyneux Drive and north-west of Cotefield Farm, Oxford Road, Bodicote, Oxfordshire*
- RPS 2014 *Specification for an archaeological evaluation of land south of blackwood Place & Molyneux Drive and north-west of Cotefield Farm, Oxford Road, Bodicote, Oxfordshire*
- Stace, C, 1997 *New Flora of the British Isles*. 2nd edition. Cambridge University Press
- Wofram-Murray, Y, 2010 *An archaeological evaluation of land south of Blackwood Place and Molyneux Drive, and north-west of Cotefield Farm, Oxford Road, Bodicote, Oxfordshire*, Northamptonshire Archaeology report, **10/203**

MOLA  
24th September 2014



**APPENDIX: CONTEXT INVENTORY**

<b>Trench No</b>	<b>Length, width &amp; alignment</b>	<b>NGR</b>	<b>Surface height</b>	<b>Depth &amp; height of natural</b>
1	40m x 1.8m NW-SE		111.45m aOD	0.55m, 116.95m aOD
<b>Context</b>	<b>Context type</b>	<b>Description</b>	<b>Dimensions</b>	<b>Artefacts/samples</b>
101	Topsoil	Mixed yellow and red silts with ironstone inclusions	0.30m thick	Flint
102	Subsoil	Dark grey-brown silt	0.25m thick	
104	Natural	Mid brown silt		

<b>Trench No</b>	<b>Length, width &amp; alignment</b>	<b>NGR</b>	<b>Surface height</b>	<b>Depth &amp; height of natural</b>
2	40m x 1.8m S-N + E-W		108.54m aOD	0.50m, 108.04m aOD
<b>Context</b>	<b>Context type</b>	<b>Description</b>	<b>Dimensions</b>	<b>Artefacts/samples</b>
201	Topsoil	Dark grey-brown silt	0.30m thick	Flint
202	Subsoil	Mid brown silt	0.20m thick	-
203	Fill of [205]	Mid brown silt	0.10m thick	Pottery
204	Fill of [205]	Mid red-brown silty clay	0.10m thick	-
205	Ditch	Shallow linear, wide concave base	0.20m deep 0.75m wide	-
206	Ditch	Linear N-S, flat-based, V-shaped	0.42m deep 1.2m wide	-
207	Fill of [206]	Mid red-brown clay silt, occasional charcoal flecks, occasional small to medium rounded and sub-rounded ironstone inclusions	-	Pottery and flint
208	Ditch	Linear N-S, flat-based, V-shaped	0.50m deep 0.80m wide	-
209	Fill of [208]	Mid red-brown clay silt, occasional small to medium sub-rounded ironstone inclusions, occasional charcoal flecks	-	-
210	Natural	Mixed yellow and red silts with ironstone inclusions	-	-

Trench No	Length, width & alignment	NGR	Surface height	Depth & height of natural
3	40m x 1.8m NW-SE		108.18m aOD	0.76m, 107.42m aOD
<i>Context</i>	<i>Context type</i>	<i>Description</i>	<i>Dimensions</i>	<i>Artefacts/samples</i>
301	Topsoil	Mid brown-grey silty loam, moderate small to medium ironstone inclusions	0.25m thick	Flint
302	Subsoil	Mid orange-brown clay silt, moderate small stones	0.56m thick	Flint
303	Colluvium	Mid grey-brown clay silt, occasional small stones	-	Flint
304	Natural	Light brown-yellow sandy silt, frequent ironstone inclusions	-	-
305	Fill of [306]	Friable black sandy silt with very frequent charcoal	-	Clay tobacco pipe, pottery
306	Ditch	Shallow, concave base	0.16m deep	-

Trench No	Length, width & alignment	NGR	Surface height	Depth & height of natural
4	40m x 1.8m NW-SE		108.14m aOD	0.82m, 107.32m aOD
<i>Context</i>	<i>Context type</i>	<i>Description</i>	<i>Dimensions</i>	<i>Artefacts/samples</i>
401	Topsoil	Mid brown-grey silty loam, moderate small to medium ironstone inclusions	0.23m thick	Flint
402	Subsoil	Mid orange-brown clay silt, moderate small stones	0.59m thick	Flint
403	Colluvium	Mid grey-brown clay silt, occasional small stones	-	Pot
404	Natural	Light brown-yellow sandy silt, frequent ironstone inclusions	-	-
405	Fill of [406]	Friable dark grey-brown silty loam with frequent charcoal inclusions	0.22m thick	Animal bone, Slag
406	Ditch	Linear feature with U-Shaped profile, gentle slope to sides and concave base	W:0.81m D:0.22m	-
407	Possible cremation burial	Circular cut. Feature not excavated	Diameter: 0.32m	-
408	Possible cremation burial	Circular cut. Feature not excavated	Diameter: 0.24m	-
409	Fill of [410]	Fill of unexcavated feature. Mid red-brown sandy clay	-	-
410	Ditch	Linear feature, NE-SW, may be enclosure ditch identified in other trenches	W:2.5m	-

Trench No	Length, width & alignment	NGR	Surface height	Depth & height of natural
5	20m x 1.8m E-W		106.05m aOD	0.75m, 105.30m aOD
Context	Context type	Description	Dimensions	Artefacts/samples
501	Topsoil	Mid grey brown clay loam with moderate small to medium sub-angular ironstone	0.31m thick	-
502	Subsoil	Light orange-yellow silty clay with frequent small to medium ironstone and sandstone	0.44m thick	-
503	Natural	Light yellow-grey clay with moderate small to large sub-angular ironstone	-	-

Trench No	Length, width & alignment	NGR	Surface height	Depth & height of natural
6	40m x 1.8m NE-SW		110.47m aOD	0.51m, 109.96m aOD
Context	Context type	Description	Dimensions	Artefacts/samples
601	Topsoil	Mid grey-brown clay loam with moderate small to medium sub-angular ironstone	0.26m thick	Flint
602	Subsoil	Mid orange-brown clay silt with occasional small sub-angular ironstone	0.25m thick	-
603	Natural	Mid yellow-grey silty clay with frequent small to large ironstone	-	-
604	Fill of [605]	Medium-firm mid brown-red sandy clay with occasional small angular ironstone	0.37m	-
605	Ditch	Linear feature on NE-SW orientation with straight sides and slightly curved base	W:0.93m D:0.37m	-
606	Fill of [607]	Medium-firm mid brown-red sandy clay with occasional small angular ironstone	W:0.64m D:0.36m	-
607	Ditch	Linear feature on NE-SW orientation with straight sides and curved base	W:0.64m D:0.36m	-
608	Fill of [609]	Medium-firm mid brown-red sandy clay with occasional small angular ironstone	W:0.42m D:0.38m	-
609	Ditch	Linear feature on NE-SW orientation with straight sides and slightly curved base	W:0.42m D:0.38m	-
610	Fill of [611]	Friable mid brown-orange silt with occasional manganese, small-med ironstone and very rare flecks of charcoal. Excavated by machine	D:1m+	Pot, flint, fired clay, clay tobacco pipe
611	Field boundary	Linear feature on uncertain orientation. Wide and deep profile with gently sloping sides. Not fully excavated	D:1m+	

<b>Trench No</b>	<b>Length, width &amp; alignment</b>	<b>NGR</b>	<b>Surface height</b>	<b>Depth &amp; height of natural</b>
7	40m x 1.8m NE-SW		112.99m aOD	0.46m, 112.53m aOD
<b>Context</b>	<b>Context type</b>	<b>Description</b>	<b>Dimensions</b>	<b>Artefacts/samples</b>
701	Topsoil	Mid grey-brown clay loam with moderate small to medium sub-angular ironstone	0.22m	Flint
702	Subsoil	Mid orange-brown silty clay with occasional small sub-angular ironstone	0.24m	-
703	Natural	Mid blue-grey and orange-brown mottled silty clay. High ironstone content	-	-
704	Fill of [705]	Friable-firm mid yellow-brown clayey silt with occasional charcoal inclusions	D:0.11m	-
705	Gully	Linear feature on NW-SE orientation	W:0.63m D:0.11m	-
706	Fill of [707]	Friable-firm mid red-brown silty clay	D:0.10m	Post-medieval pot
707	Furrow	Linear feature on NW-SE orientation	W:1.00m D:0.10m	-
708	Layer	Dark orange-brown layer with frequent ironstone and occasional charcoal inclusions	D:0.17m	Pot

<b>Trench No</b>	<b>Length, width &amp; alignment</b>	<b>NGR</b>	<b>Surface height</b>	<b>Depth &amp; height of natural</b>
8	40m x 1.8m NW-SE		112.34m aOD	0.42m, 111.92m aOD
<b>Context</b>	<b>Context type</b>	<b>Description</b>	<b>Dimensions</b>	<b>Artefacts/samples</b>
801	Topsoil	Mid grey-brown clay loam with moderate small to medium sub-angular ironstone	0.11m thick	Flint, pottery
802	Subsoil	Light orange-yellow silty clay with frequent small to medium ironstone and sandstone	0.31m thick	-
803	Natural	Light yellow and orange grey silty clay with frequent ironstone inclusions	-	-
804	Fill of [805]	Friable-firm light grey-brown clayey silt with occasional small sub-rounded stones	W:1.64m D:0.16m	Pot
805	Furrow	Linear cut on NE-SW orientation with shallow U-shaped profile and irregular-flat base	W:1.64m D:0.16m	-
806	Fill of [807]	Firm dark grey-brown silty clay with frequent small ironstone	W:0.82m D:0.23m	A.Bone
807	Ditch	Linear cut on NE-SW orientation with gentle-moderately sloped U-shaped profile and concave base	W:0.82m D:0.23m	-
808	Fill of [809]	Firm dark grey-brown silty clay with occasional charcoal flecks and ironstone inclusions	W:0.66m D:0.52m	Sample 3
809	Ditch terminal.	Eastern terminal of linear cut on E-W alignment with steep sides and flat-concave base	W:0.66m D:0.52m	-
810	Fill of [811]	Firm dark grey-brown silty clay with frequent charcoal and burnt stone inclusions	W:0.32m D:0.04m	Animal bone, fired clay Sample 2
811	Linear feature	Linear cut on E-W orientation with gentle slope to sides and concave-irregular base	W:0.32m D:0.04m	-



<b>Trench No</b>	<b>Length, width &amp; alignment</b>	<b>NGR</b>	<b>Surface height</b>	<b>Depth &amp; height of natural</b>
9	40m x 1.8m NE-SW		110.77m aOD	0.41m, 110.36m aOD
<b>Context</b>	<b>Context type</b>	<b>Description</b>	<b>Dimensions</b>	<b>Artefacts/samples</b>
901	Topsoil	Mid grey-brown clay loam with moderate small to medium sub-angular ironstone	0.20m thick	Flint
902	Subsoil	Light orange-yellow silty clay with frequent small to medium ironstone and sandstone	0.21m thick	-
903	Natural	Light grey-yellow sandy clay with occasional small sub-angular ironstone inclusions	-	-
904	Fill of [907]	Medium-firm mid brown-grey silty sandy clay with occasional small angular ironstone	W:2.64m	-
905	Fill of [907]	Soft-medium light-mid yellow-brown clayey sand	W:0.90m	-
906	Fill of [907]	Medium mid brown-grey silty sandy clay with occasional ironstone inclusions	W:1.20m	-
907	Ditch	Linear cut on N-S orientation with straight, slightly uneven, sides and uncertain base. Excavation of feature abandoned at depth of 1.5m	W:4.72m	-

<b>Trench No</b>	<b>Length, width &amp; alignment</b>	<b>NGR</b>	<b>Surface height</b>	<b>Depth &amp; height of natural</b>
10	40m x 1.8m NNW-SSE		109.86m aOD	0.39m, 109.47m aOD
<b>Context</b>	<b>Context type</b>	<b>Description</b>	<b>Dimensions</b>	<b>Artefacts/samples</b>
1001	Topsoil	Mid grey-brown clay loam with moderate small to medium sub-angular ironstone	0.20m thick	-
1002	Subsoil	Light orange-yellow silty clay with frequent small to medium ironstone and sandstone	0.19m thick	-
1003	Natural	Light yellow-grey clay with moderate small to large sub-angular ironstone. SE end of trench was stonier	-	-
1004	Fill of [1007]	Medium-compact mid-dark brown-grey silty sandy clay with occasional ironstone	D:1.00m	Flint, animal bone, fired clay Sample 1
1005	Fill of [1007]	Medium-compact mid grey silty clay	D:0.18m	-
1006	Fill of [1007]	Medium mid brown silty clay with occasional small angular ironstone	-	-
1007	Ditch	Linear cut on E-W orientation with straight sides and uncertain base. Feature not fully excavated	W:3.50m D:1.60m excavated	-
1008	Fill of [1009]	Medium mid brown silty sandy clay	W:0.60m D:0.10m	-
1009	Gully	Linear cut on E-W orientation with uneven sides and uneven base. May be band of natural	W:0.60m D:0.10m	-
1010	Fill of [1011]	Medium mid brown silty sandy clay	W:0.35m D:0.09m	-
1011	Gully	Linear cut on E-W orientation with uneven sides and uneven base. May be band of natural	W:0.35m D:0.09m	-
1012	Fill of [1013]	Medium mid brown silty clay	W:1.20m D:0.20m	-
1013	Pit	Elliptical cut with uneven sides and uneven base. May be result of bioturbation	W:1.20m D:0.20m	-

<b>Trench No</b>	<b>Length, width &amp; alignment</b>	<b>NGR</b>	<b>Surface height</b>	<b>Depth &amp; height of natural</b>
11	40m x 1.8m NE-SW		106.11m aOD	0.55m, 105.56m aOD
<b>Context</b>	<b>Context type</b>	<b>Description</b>	<b>Dimensions</b>	<b>Artefacts/samples</b>
1101	Topsoil	Mid grey brown clay loam with moderate small to medium sub-angular ironstone.	0.30m thick	Flint
1102	Subsoil	Light orange-yellow silty clay with frequent small to medium ironstone and sandstone.	0.25m	-
1103	Natural	Light grey-yellow silty clay with frequent small to medium sub-angular ironstone fragments	-	-
1104	Layer	Layer of colluvium	-	Flint, pottery
1105	Fill of [1106]	Friable-firm mid brown silty clay with very infrequent small stones	W:0.45m D:0.08m	-
1106	Gully	Linear cut on NW-SE orientation with very shallow U-shaped profile and flat-concave base	W:0.45m D:0.08m	-
1107	Fill of [1108]	Firm mid brown silty clay with very infrequent charcoal flecks and very infrequent small stones	W:1.06m D:0.18m	-
1108	Ditch	Linear cut on NW-SE orientation with U-shaped profile and concave base.	W:1.06m D:0.18m	-
1109	Fill of [1110]	Firm mid brown silty clay	W:0.70m D:0.15m	-
1110	Ditch	Linear cut on NW-SE orientation with broad U-shaped profile and slightly concave base	W:0.70m D:0.15m	-
1111	Fill of [1112]	Firm mid orange-brown silty clay with infrequent small stones and charcoal flecks	W:0.70m D:0.07m	-
1112	Furrow	Linear cut on NW-SE orientation with shallow broad U-shaped profile and flat-concave base	W:0.70m D:0.07m	-
1113	Fill of [1114]	Firm mid brown silty clay with very infrequent small stones and infrequent charcoal flecks	W:0.49m D:0.17m	-
1114	Ditch	Linear cut on NW-SE orientation with U-shaped profile and concave base	W:0.49m D:0.17m	-



MOLA  
Bolton House  
Wootton Hall Park  
Northampton  
NN4 8BN  
01604 700 493  
[www.mola.org.uk](http://www.mola.org.uk)  
[sparry@mola.org.uk](mailto:sparry@mola.org.uk)