

### Ordnance Survey Plan

Published 1982 - 1988

Source map scale - 1:10,000

The historical maps shown were reproduced from maps predominantly held at the scale adopted for England, Wales and Scotland in the 1840's. In 1854 the 1:2,500 scale was adopted for mapping urban areas; these maps were used to update the 1:10,560 maps. The published date given therefore is often some years later than the surveyed date. Before 1938, all OS maps were based on the Cassini Projection, with independent surveys of a single county or group of counties, giving rise to significant inaccuracies in outlying areas. In the late 1940's, a Provisional Edition was produced, which updated the 1:10,560 mapping from a number of sources. The maps appear unfinished - with all military camps and other strategic sites removed. These maps were initially overprinted with the National Grid. In 1970, the first 1:10,000 maps were produced using the Transverse Mercator Projection. The revision process continued until recently, with new editions appearing every 10 years or so for urban areas.

### Map Name(s) and Date(s)

SP52NW	SP52NE
1982	1982
1:10,000	1:10,000
SP52SW	SP52SE
1982	1988
1:10,000	1:10,000

### Historical Map - Slice C

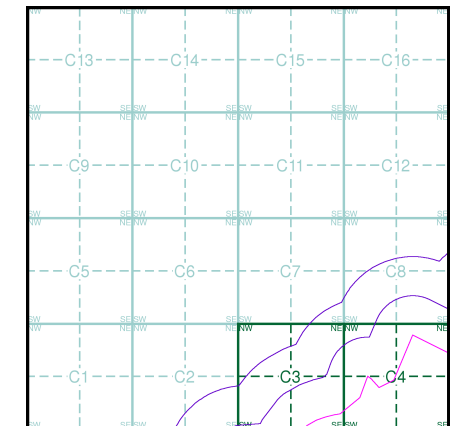

### Order Details

Order Number: 31544761\_1\_1  
 Customer Ref: UA001881  
 National Grid Reference: 456330, 224990  
 Slice: C  
 Site Area (Ha): 395.55  
 Search Buffer (m): 500

### Site Details

Site at, Bicester, Oxfordshire

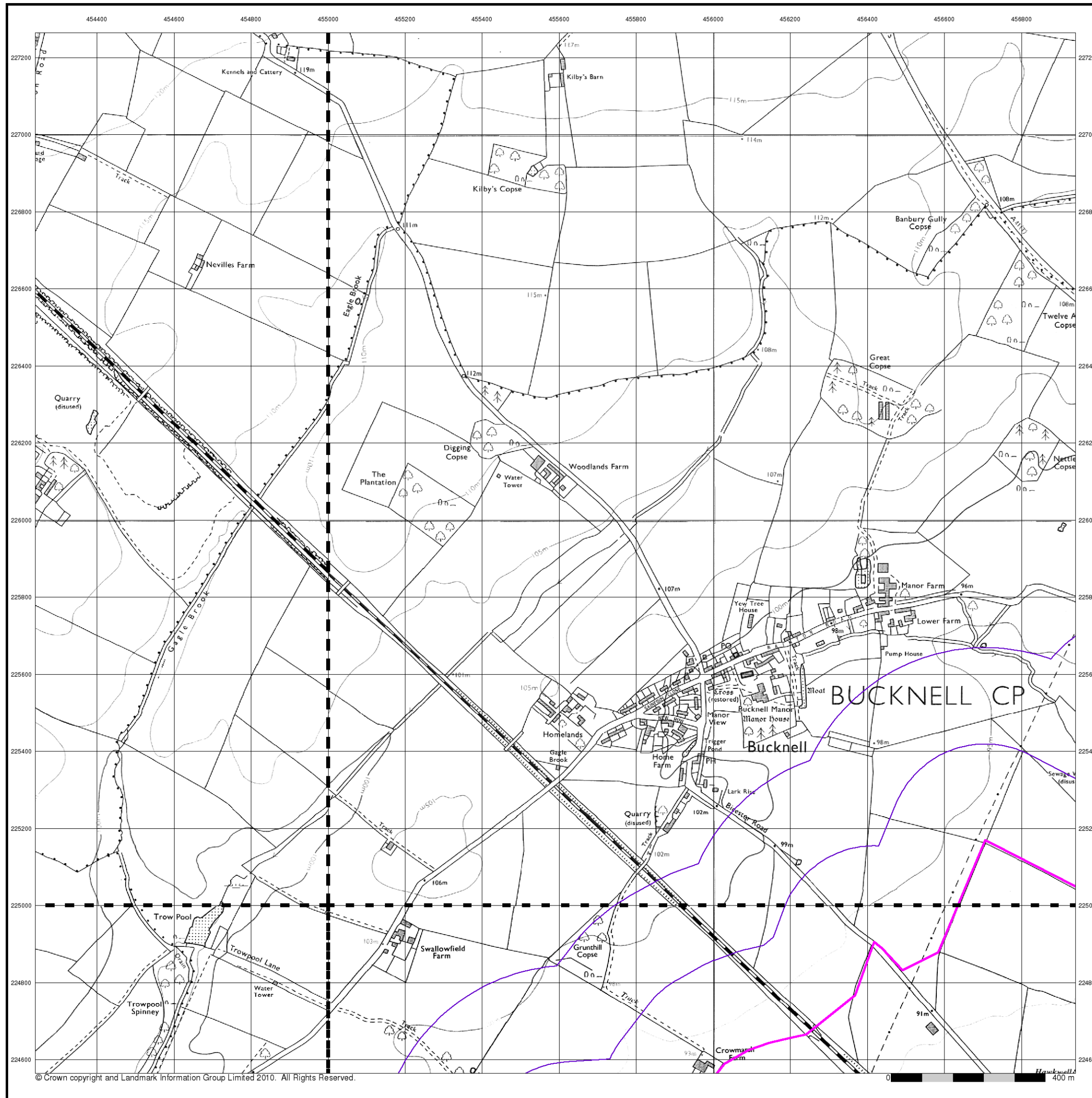

### Ordnance Survey Plan

Published 1993 - 1996

Source map scale - 1:10,000

The historical maps shown were reproduced from maps predominantly held at the scale adopted for England, Wales and Scotland in the 1840's. In 1854 the 1:2,500 scale was adopted for mapping urban areas; these maps were used to update the 1:10,560 maps. The published date given therefore is often some years later than the surveyed date. Before 1938, all OS maps were based on the Cassini Projection, with independent surveys of a single county or group of counties, giving rise to significant inaccuracies in outlying areas. In the late 1940's, a Provisional Edition was produced, which updated the 1:10,560 mapping from a number of sources. The maps appear unfinished - with all military camps and other strategic sites removed. These maps were initially overprinted with the National Grid. In 1970, the first 1:10,000 maps were produced using the Transverse Mercator Projection. The revision process continued until recently, with new editions appearing every 10 years or so for urban areas.

### Map Name(s) and Date(s)

SP52NW	1993	1:10,000
SP52SE	1996	1:10,000

### Historical Map - Slice C

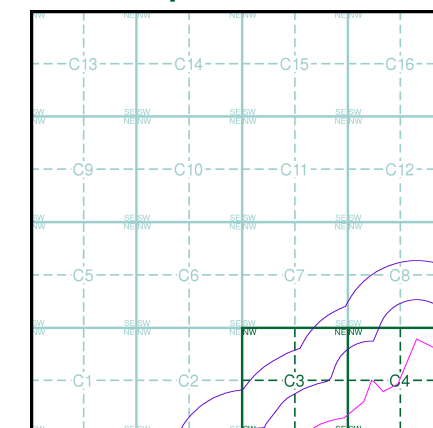

### Order Details

Order Number: 31544761\_1\_1  
 Customer Ref: UA001881  
 National Grid Reference: 456330, 224990  
 Slice: C  
 Site Area (Ha): 395.55  
 Search Buffer (m): 500

### Site Details

Site at, Bicester, Oxfordshire

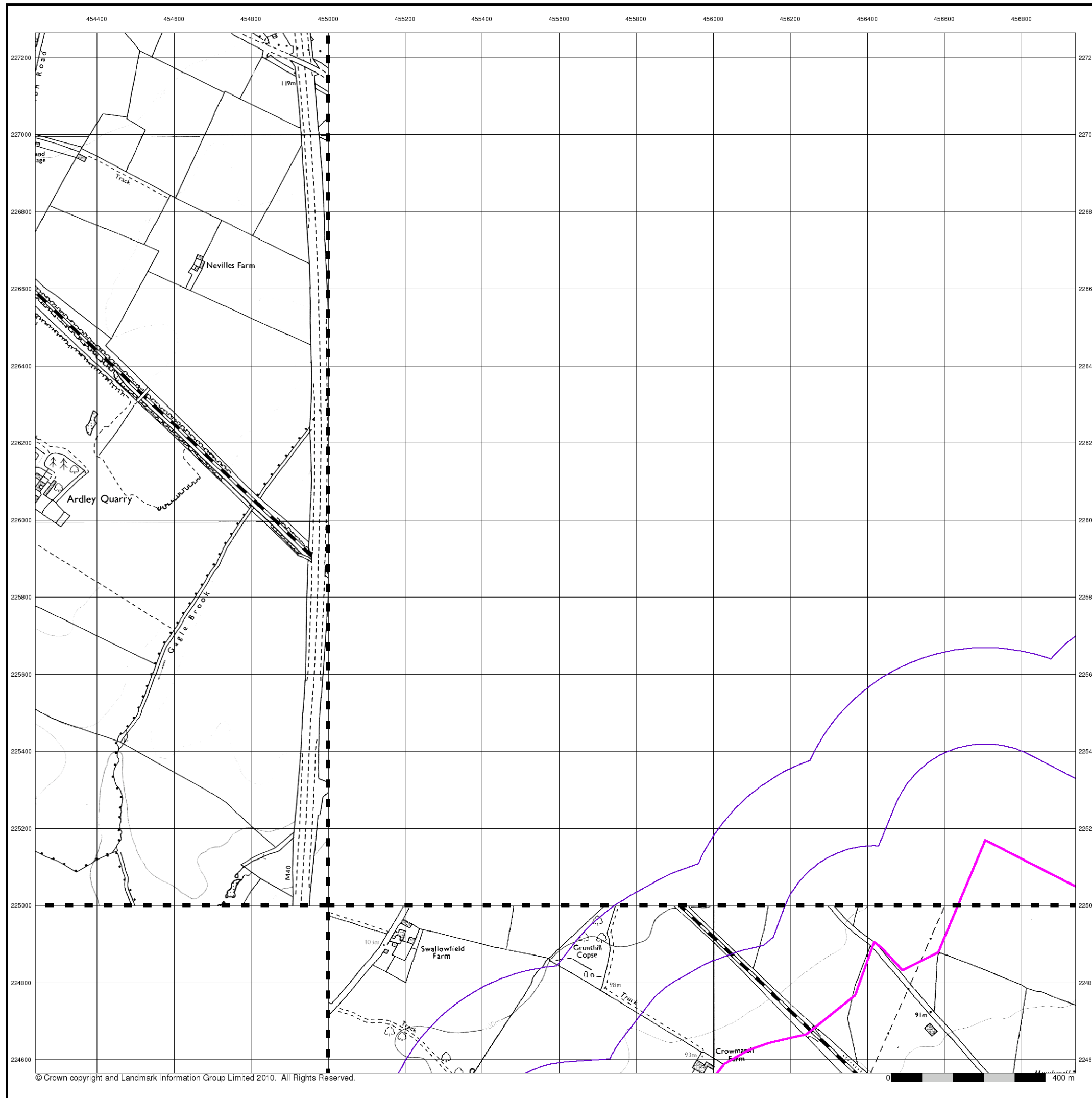

### 10k Raster Mapping

Published 1999

Source map scale - 1:10,000

The historical maps shown were produced from the Ordnance Survey's 1:10,000 colour raster mapping. These maps are derived from Landplan which replaced the old 1:10,000 maps originally published in 1970. The data is highly detailed showing buildings, fences and field boundaries as well as all roads, tracks and paths. Road names are also included together with the relevant road number and classification. Boundary information depiction includes county, unitary authority, district, civil parish and constituency.

### Map Name(s) and Date(s)

SP52NW 1999 1:10,000	SP52NE 1999 1:10,000
SP52SW 1999 1:10,000	SP52SE 1999 1:10,000

### Historical Map - Slice C

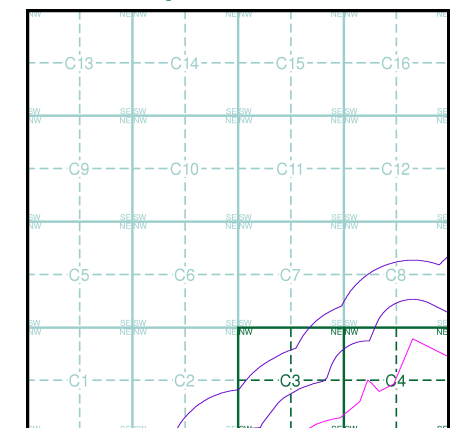

### Order Details

Order Number: 31544761\_1\_1  
 Customer Ref: UA001881  
 National Grid Reference: 456330, 224990  
 Slice: C  
 Site Area (Ha): 395.55  
 Search Buffer (m): 500

### Site Details

Site at, Bicester, Oxfordshire

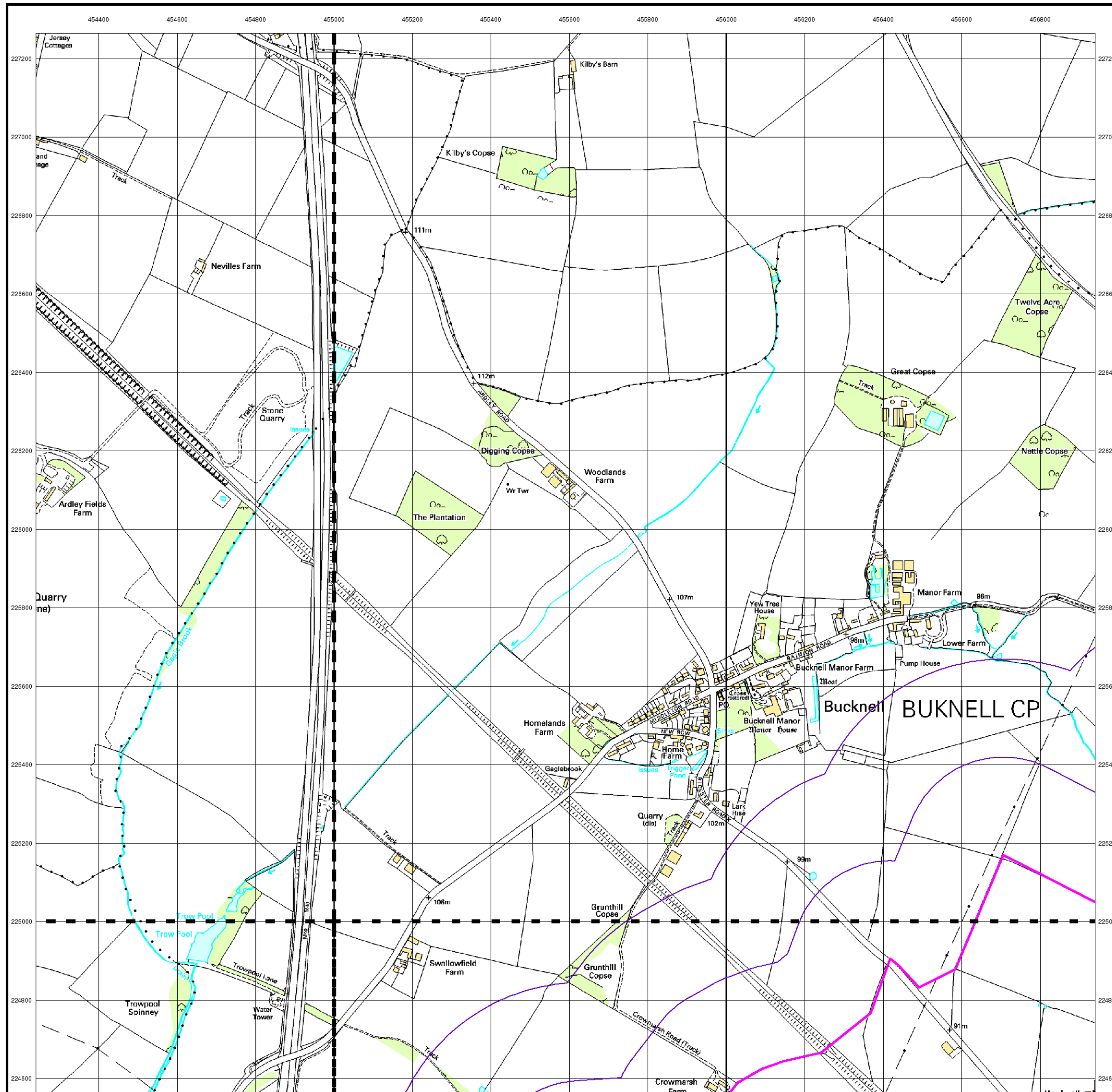

### 10k Raster Mapping

Published 2006

Source map scale - 1:10,000

The historical maps shown were produced from the Ordnance Survey's 1:10,000 colour raster mapping. These maps are derived from Landplan which replaced the old 1:10,000 maps originally published in 1970. The data is highly detailed showing buildings, fences and field boundaries as well as all roads, tracks and paths. Road names are also included together with the relevant road number and classification. Boundary information depiction includes county, unitary authority, district, civil parish and constituency.

### Map Name(s) and Date(s)

SP52NW 2006 1:10,000	SP52NE 2006 1:10,000
SP52SW 2006 1:10,000	SP52SE 2006 1:10,000

### Historical Map - Slice C

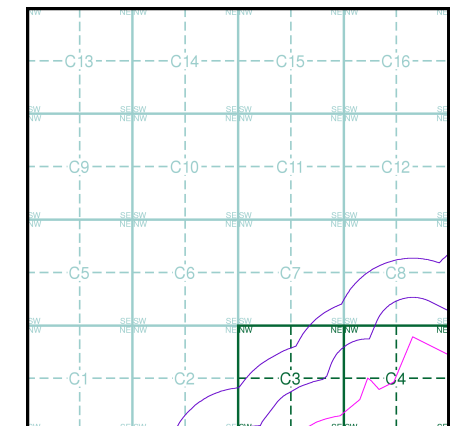

### Order Details

Order Number: 31544761\_1\_1  
 Customer Ref: UA001881  
 National Grid Reference: 456330, 224990  
 Slice: C  
 Site Area (Ha): 395.55  
 Search Buffer (m): 500

### Site Details

Site at, Bicester, Oxfordshire

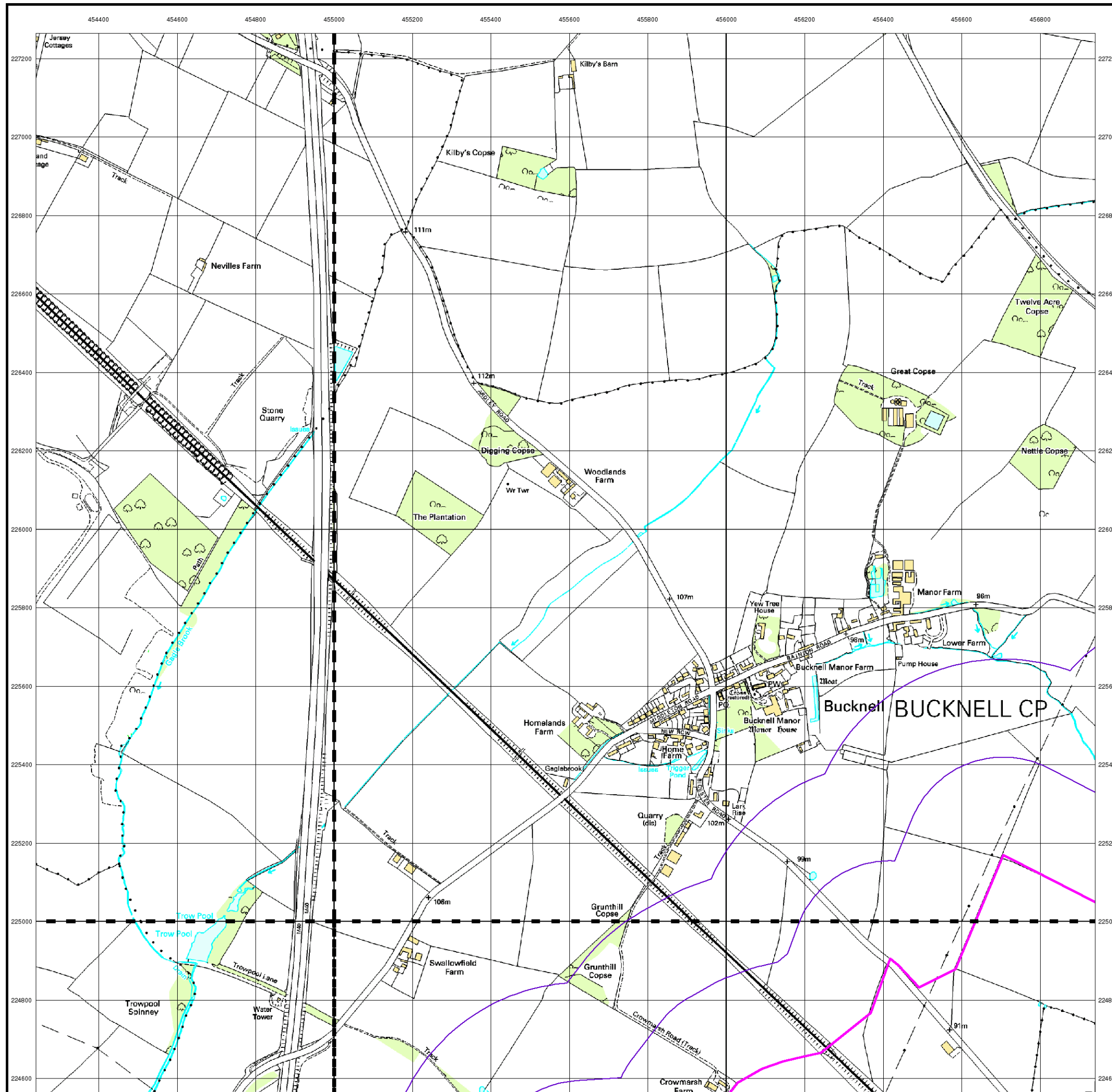

## 10k Raster Mapping

Published 2010

Source map scale - 1:10,000

The historical maps shown were produced from the Ordnance Survey's 1:10,000 colour raster mapping. These maps are derived from Landplan which replaced the old 1:10,000 maps originally published in 1970. The data is highly detailed showing buildings, fences and field boundaries as well as all roads, tracks and paths. Road names are also included together with the relevant road number and classification. Boundary information depiction includes county, unitary authority, district, civil parish and constituency.

### Map Name(s) and Date(s)

SP52NW	SP52NE
2010	2010
1:10,000	1:10,000
SP52SW	SP52SE
2010	2010
1:10,000	1:10,000

### Historical Map - Slice C

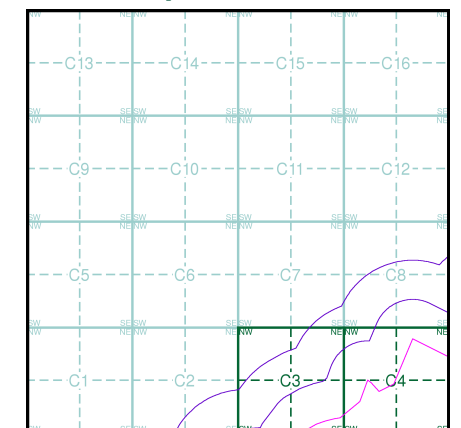

### Order Details

Order Number: 31544761\_1\_1  
 Customer Ref: UA001881  
 National Grid Reference: 456330, 224990  
 Slice: C  
 Site Area (Ha): 395.55  
 Search Buffer (m): 500

### Site Details

Site at, Bicester, Oxfordshire

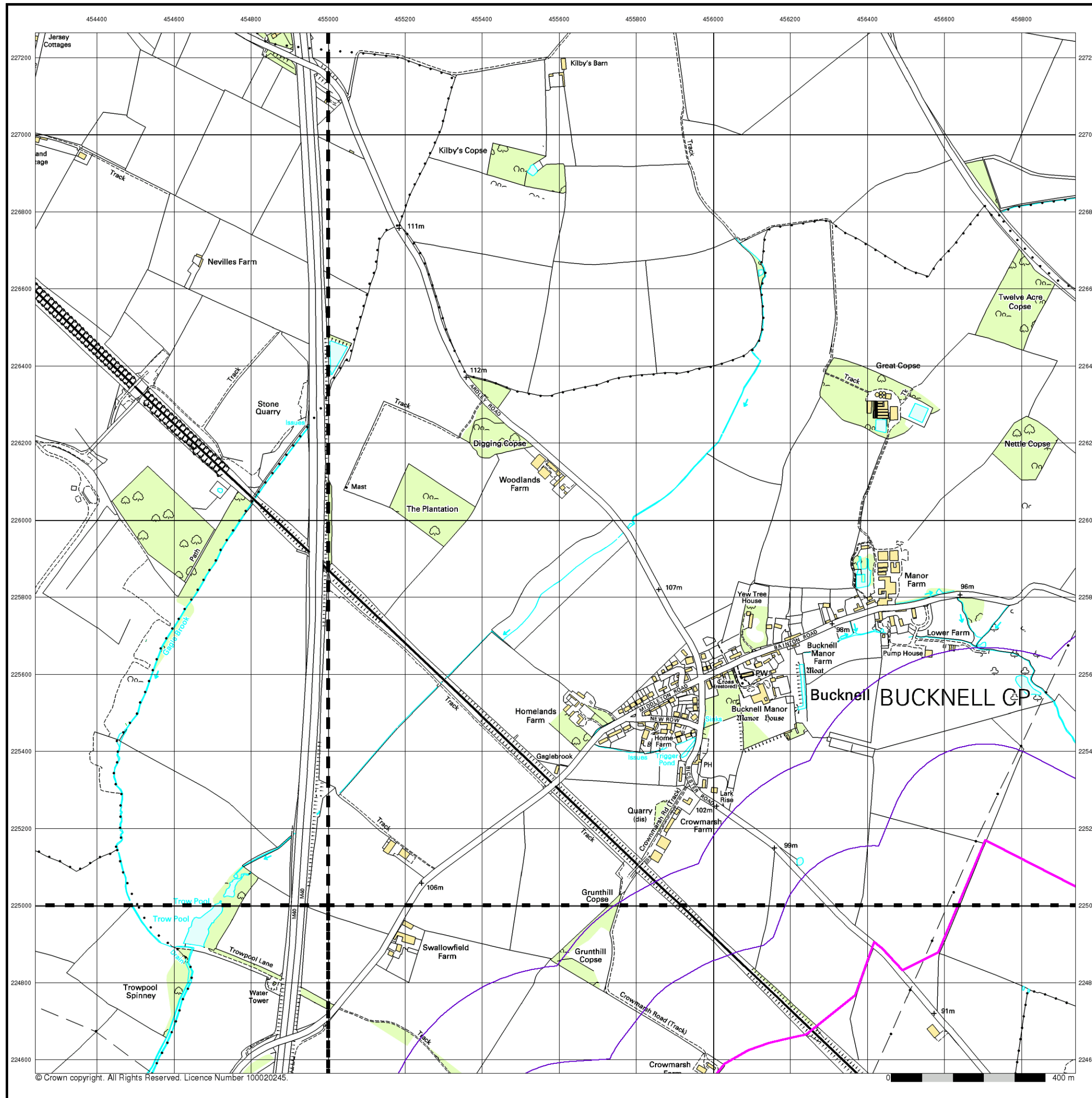

# Historical Mapping Legends

## Ordnance Survey County Series 1:10,560

- Gravel Pit
- Sand Pit
- Other Pits
- Quarry
- Shingle
- Orchard
- Osiers
- Reeds
- Marsh
- Mixed Wood
- Deciduous
- Brushwood
- Fir
- Furze
- Rough Pasture
- Arrow denotes flow of water
- Trigonometrical Station
- Site of Antiquities
- Bench Mark
- Pump, Guide Post, Signal Post
- Well, Spring, Boundary Post
- 285** Surface Level
- Sketched Contour
- Instrumental Contour
- Main Roads
- Minor Roads
- Sunken Road
- Raised Road
- Road over Railway
- Railway over River
- Railway over Road
- Level Crossing
- Road over River or Canal
- Road over Stream
- Road over Stream
- County Boundary (Geographical)
- County & Civil Parish Boundary
- Administrative County & Civil Parish Boundary
- County Borough Boundary (England)
- County Burgh Boundary (Scotland)
- Rural District Boundary
- Civil Parish Boundary

## Ordnance Survey Plan 1:10,000

- Chalk Pit, Clay Pit or Quarry
- Gravel Pit
- Sand Pit
- Disused Pit or Quarry
- Refuse or Slag Heap
- Lake, Loch or Pond
- Dunes
- Boulders
- Coniferous Trees
- Non-Coniferous Trees
- Orchard
- Scrub
- Coppice
- Bracken
- Heath
- Rough Grassland
- Marsh
- Reeds
- Saltings
- Building
- Glasshouse
- Sloping Masonry
- Pylon
- Electricity Transmission Line
- Pole
- Cutting
- Embankment
- Standard Gauge Multiple Track
- Standard Gauge Single Track
- Siding, Tramway or Mineral Line
- Narrow Gauge
- Geographical County
- Administrative County, County Borough or County of City
- Municipal Borough, Urban or Rural District, Burgh or District Council
- Borough, Burgh or County Constituency
- Civil Parish
- BP, BS** Boundary Post or Stone
- Ch** Church
- CH** Club House
- F E Sta** Fire Engine Station
- FB** Foot Bridge
- Fn** Fountain
- GP** Guide Post
- MP** Mile Post
- MS** Mile Stone
- Pol Sta** Police Station
- PO** Post Office
- PC** Public Convenience
- PH** Public House
- SB** Signal Box
- Spr** Spring
- TCB** Telephone Call Box
- TCP** Telephone Call Post
- W** Well

## 1:10,000 Raster Mapping

- Gravel Pit
- Rock
- Boulders
- Shingle
- Sand
- Slopes
- Refuse tip or slag heap
- Rock (scattered)
- Boulders (scattered)
- Mud
- Sand Pit
- Top of cliff
- General detail
- Overhead detail
- Multi-track railway
- County boundary (England only)
- District, Unitary, Metropolitan, London Borough boundary
- Underground detail
- Narrow gauge railway
- Single track railway
- Civil, parish or community boundary
- Constituency boundary
- Area of wooded vegetation
- Non-coniferous trees
- Coniferous trees
- Positioned tree
- Coppice or Osiers
- Heath
- Marsh, Salt Marsh or Reeds
- Flow arrows
- Mean high water (springs)
- Mean low water (springs)
- Electricity transmission line (with poles)
- Telephone line (where shown)
- Bench mark (where shown)
- Point feature (e.g. Guide Post or Mile Stone)
- Site of (antiquity)
- General Building
- Important Building

## Historical Mapping & Photography included:

Mapping Type	Scale	Date	Pg
Oxfordshire	1:10,560	1885	2
Oxfordshire	1:10,560	1900	3
Oxfordshire	1:10,560	1923	4
Oxfordshire	1:10,560	1923	5
Oxfordshire	1:10,560	1938 - 1952	6
<b>Historical Aerial Photography</b>	<b>1:10,560</b>	<b>1947</b>	<b>7</b>
Oxfordshire	1:10,560	1952	8
Ordnance Survey Plan	1:10,000	1955	9
Ordnance Survey Plan	1:10,000	1966	10
Ordnance Survey Plan	1:10,000	1970	11
Ordnance Survey Plan	1:10,000	1982 - 1988	12
Ordnance Survey Plan	1:10,000	1996	13
10K Raster Mapping	1:10,000	1999	14
10K Raster Mapping	1:10,000	2006	15
10K Raster Mapping	1:10,000	2010	16

## Historical Map - Slice D

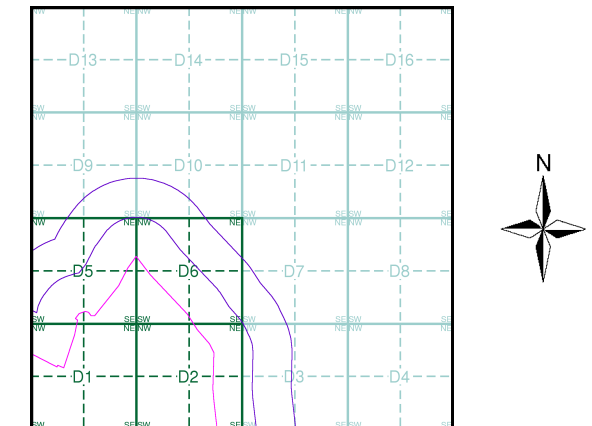

## Order Details

Order Number: 31544761\_1\_1  
 Customer Ref: UA001881  
 National Grid Reference: 457720, 225250  
 Slice: D  
 Site Area (Ha): 395.55  
 Search Buffer (m): 500

## Site Details

Site at, Bicester, Oxfordshire

Oxfordshire

Published 1885

Source map scale - 1:10,560

The historical maps shown were reproduced from maps predominantly held at the scale adopted for England, Wales and Scotland in the 1840's. In 1854 the 1:2,500 scale was adopted for mapping urban areas; these maps were used to update the 1:10,560 maps. The published date given therefore is often some years later than the surveyed date. Before 1938, all OS maps were based on the Cassini Projection, with independent surveys of a single county or group of counties, giving rise to significant inaccuracies in outlying areas. In the late 1940's, a Provisional Edition was produced, which updated the 1:10,560 mapping from a number of sources. The maps appear unfinished - with all military camps and other strategic sites removed. These maps were initially overprinted with the National Grid. In 1970, the first 1:10,000 maps were produced using the Transverse Mercator Projection. The revision process continued until recently, with new editions appearing every 10 years or so for urban areas.

Map Name(s) and Date(s)

01700	1885	1:10,560
02300	1885	1:10,560

Historical Map - Slice D

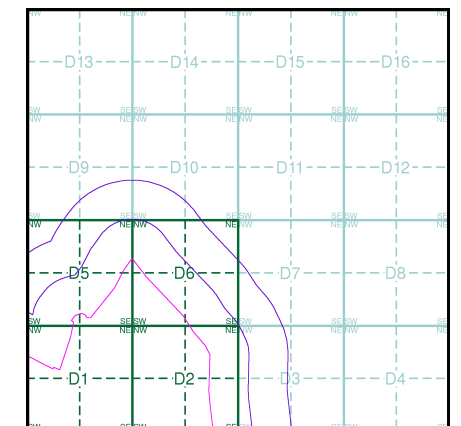

Order Details

Order Number: 31544761\_1\_1  
 Customer Ref: UA001881  
 National Grid Reference: 457720, 225250  
 Slice: D  
 Site Area (Ha): 395.55  
 Search Buffer (m): 500

Site Details

Site at, Bicester, Oxfordshire

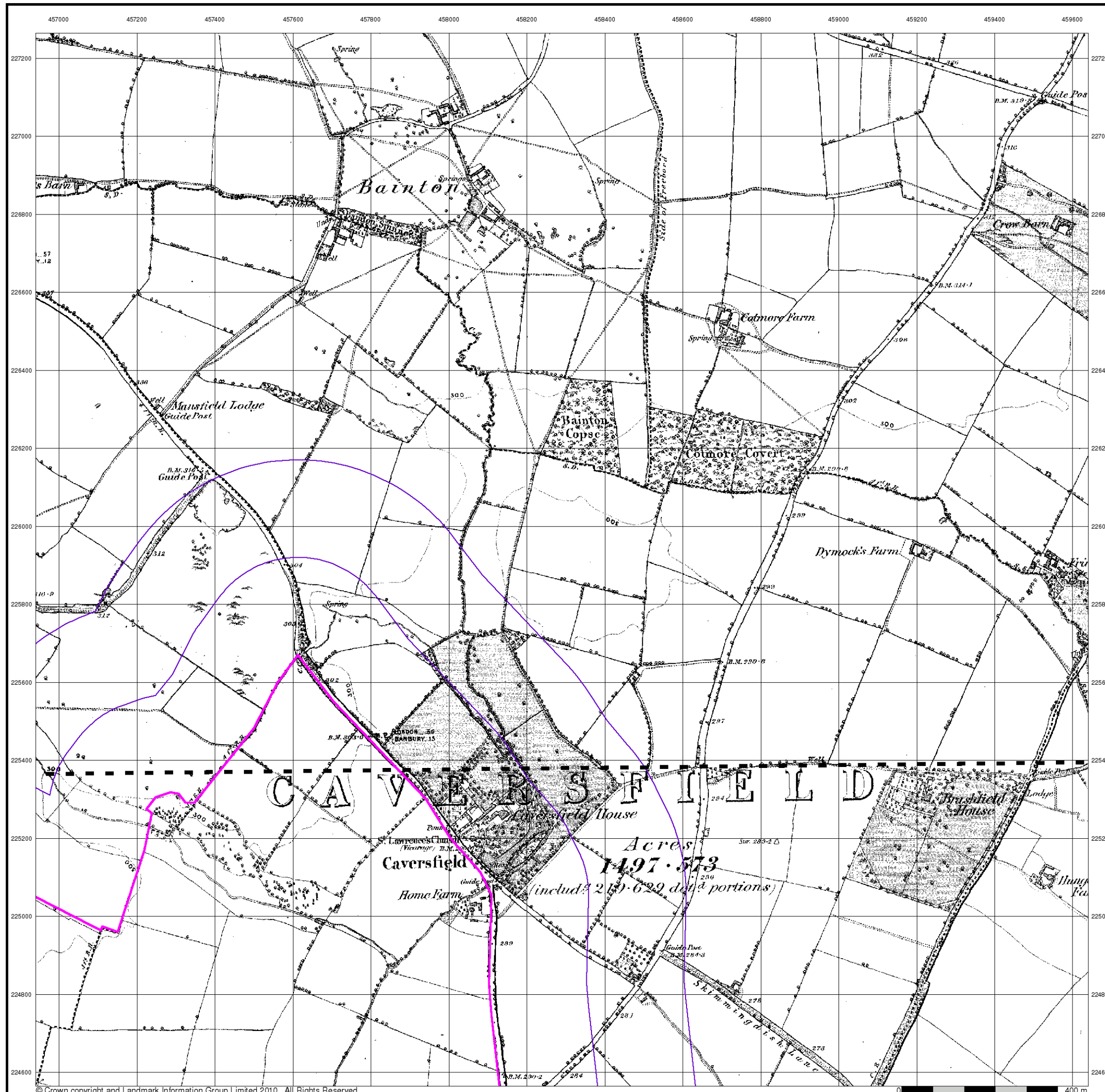

Oxfordshire

Published 1900

Source map scale - 1:10,560

The historical maps shown were reproduced from maps predominantly held at the scale adopted for England, Wales and Scotland in the 1840's. In 1854 the 1:2,500 scale was adopted for mapping urban areas; these maps were used to update the 1:10,560 maps. The published date given therefore is often some years later than the surveyed date. Before 1938, all OS maps were based on the Cassini Projection, with independent surveys of a single county or group of counties, giving rise to significant inaccuracies in outlying areas. In the late 1940's, a Provisional Edition was produced, which updated the 1:10,560 mapping from a number of sources. The maps appear unfinished - with all military camps and other strategic sites removed. These maps were initially overprinted with the National Grid. In 1970, the first 1:10,000 maps were produced using the Transverse Mercator Projection. The revision process continued until recently, with new editions appearing every 10 years or so for urban areas.

Map Name(s) and Date(s)

017SW	1900	1:10,560
023NW	1900	1:10,560

Historical Map - Slice D

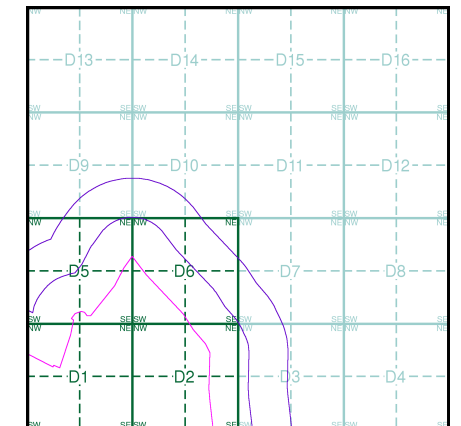

Order Details

Order Number: 31544761\_1\_1  
 Customer Ref: UA001881  
 National Grid Reference: 457720, 225250  
 Slice: D  
 Site Area (Ha): 395.55  
 Search Buffer (m): 500

Site Details

Site at, Bicester, Oxfordshire

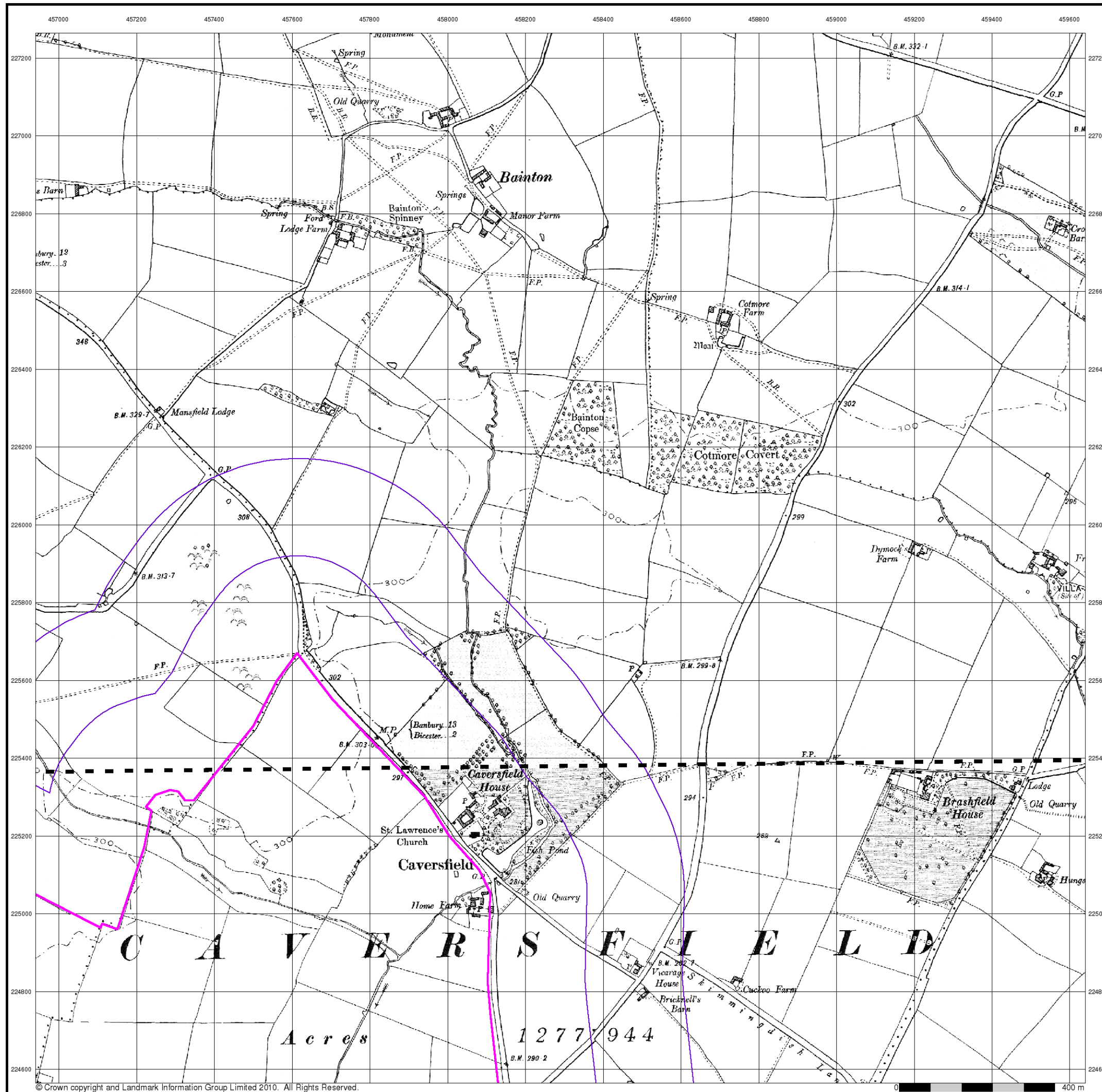



Oxfordshire

Published 1923

Source map scale - 1:10,560

The historical maps shown were reproduced from maps predominantly held at the scale adopted for England, Wales and Scotland in the 1840's. In 1854 the 1:2,500 scale was adopted for mapping urban areas; these maps were used to update the 1:10,560 maps. The published date given therefore is often some years later than the surveyed date. Before 1938, all OS maps were based on the Cassini Projection, with independent surveys of a single county or group of counties, giving rise to significant inaccuracies in outlying areas. In the late 1940's, a Provisional Edition was produced, which updated the 1:10,560 mapping from a number of sources. The maps appear unfinished - with all military camps and other strategic sites removed. These maps were initially overprinted with the National Grid. In 1970, the first 1:10,000 maps were produced using the Transverse Mercator Projection. The revision process continued until recently, with new editions appearing every 10 years or so for urban areas.

Map Name(s) and Date(s)

017SW	1923	1:10,560
023NW	1923	1:10,560

Historical Map - Slice D

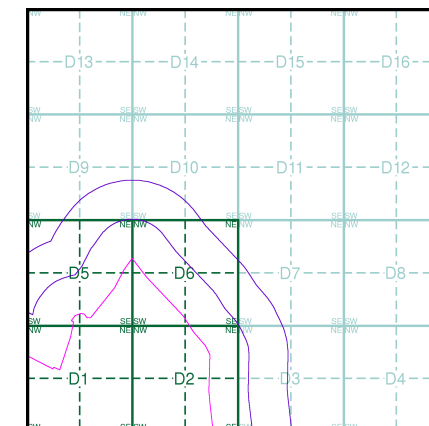

Order Details

Order Number: 31544761\_1\_1  
 Customer Ref: UA001881  
 National Grid Reference: 457720, 225250  
 Slice: D  
 Site Area (Ha): 395.55  
 Search Buffer (m): 500

Site Details

Site at, Bicester, Oxfordshire

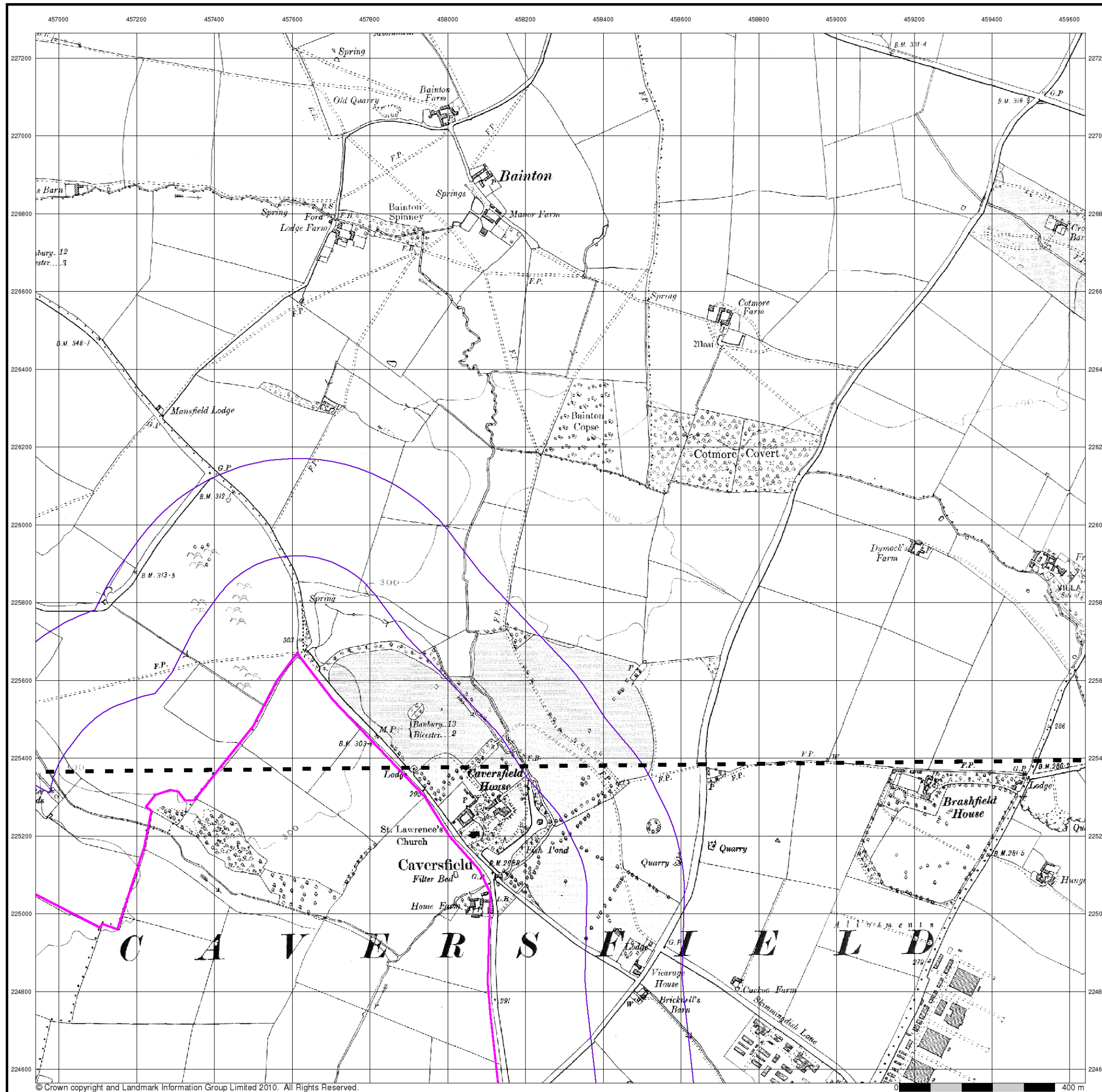

Oxfordshire

Published 1923

Source map scale - 1:10,560

The historical maps shown were reproduced from maps predominantly held at the scale adopted for England, Wales and Scotland in the 1840's. In 1854 the 1:2,500 scale was adopted for mapping urban areas; these maps were used to update the 1:10,560 maps. The published date given therefore is often some years later than the surveyed date. Before 1938, all OS maps were based on the Cassini Projection, with independent surveys of a single county or group of counties, giving rise to significant inaccuracies in outlying areas. In the late 1940's, a Provisional Edition was produced, which updated the 1:10,560 mapping from a number of sources. The maps appear unfinished - with all military camps and other strategic sites removed. These maps were initially overprinted with the National Grid. In 1970, the first 1:10,000 maps were produced using the Transverse Mercator Projection. The revision process continued until recently, with new editions appearing every 10 years or so for urban areas.

Map Name(s) and Date(s)

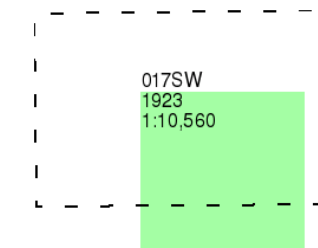

Historical Map - Slice D

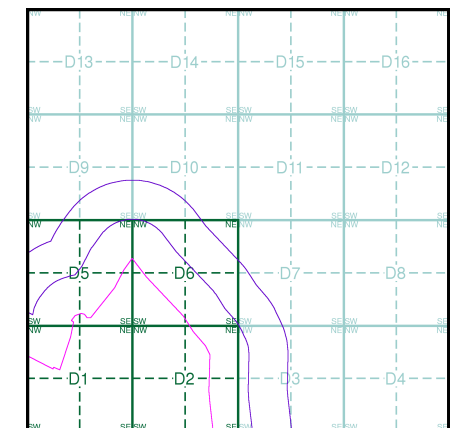

Order Details

Order Number: 31544761\_1\_1  
 Customer Ref: UA001881  
 National Grid Reference: 457720, 225250  
 Slice: D  
 Site Area (Ha): 395.55  
 Search Buffer (m): 500

Site Details

Site at, Bicester, Oxfordshire

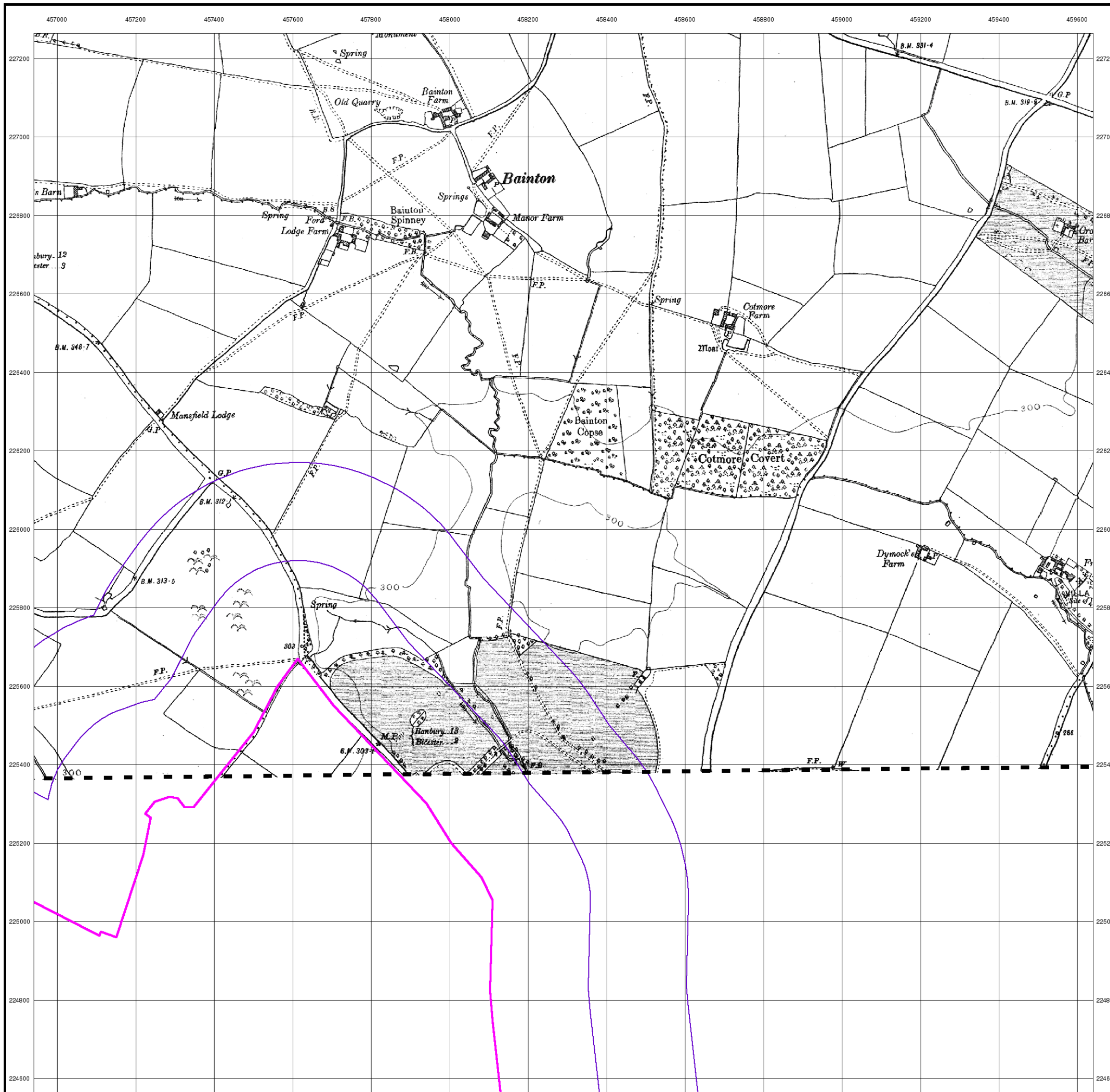

Oxfordshire

Published 1938 - 1952

Source map scale - 1:10,560

The historical maps shown were reproduced from maps predominantly held at the scale adopted for England, Wales and Scotland in the 1840's. In 1854 the 1:2,500 scale was adopted for mapping urban areas; these maps were used to update the 1:10,560 maps. The published date given therefore is often some years later than the surveyed date. Before 1938, all OS maps were based on the Cassini Projection, with independent surveys of a single county or group of counties, giving rise to significant inaccuracies in outlying areas. In the late 1940's, a Provisional Edition was produced, which updated the 1:10,560 mapping from a number of sources. The maps appear unfinished - with all military camps and other strategic sites removed. These maps were initially overprinted with the National Grid. In 1970, the first 1:10,000 maps were produced using the Transverse Mercator Projection. The revision process continued until recently, with new editions appearing every 10 years or so for urban areas.

Map Name(s) and Date(s)

017SW	1952	1:10,560
023NW	1938	1:10,560

Historical Map - Slice D

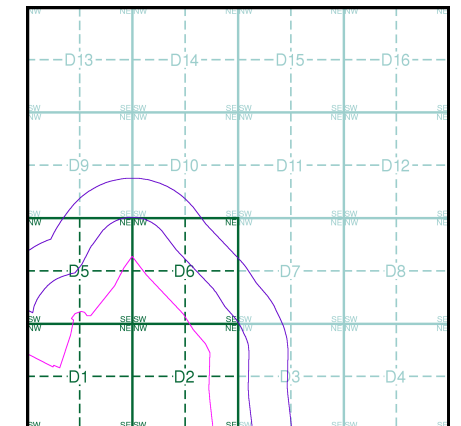

Order Details

Order Number: 31544761\_1\_1  
 Customer Ref: UA001881  
 National Grid Reference: 457720, 225250  
 Slice: D  
 Site Area (Ha): 395.55  
 Search Buffer (m): 500

Site Details

Site at, Bicester, Oxfordshire

