

REVISION/S:

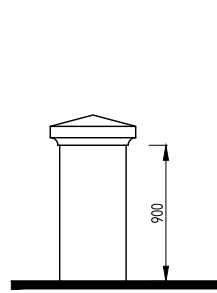

□ □ □ 900mm High Pier

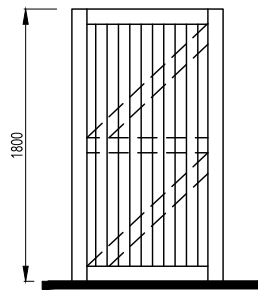

1800mm High Side Access Gate

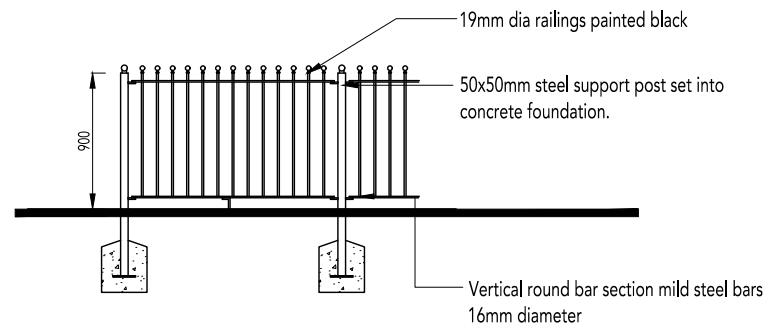

900mm High Estate Railings

PLEASE NOTE:

MATERIALS TO SCREEN WALLS & MASONRY PIERS TO BE INDICATED ON MATERIALS LAYOUT DRG NO: 0521-PH5-108.

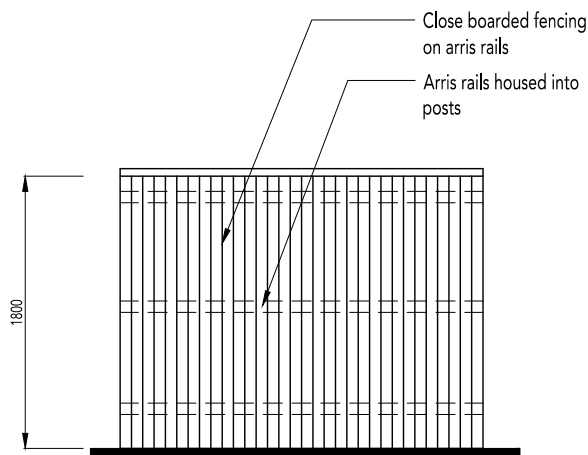

1800mm High Close Board Fence

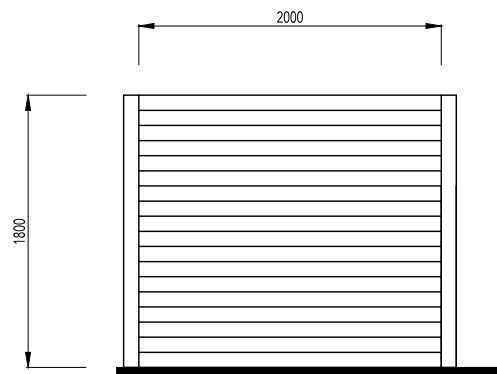

1800mm High Plot Division Panel Fence

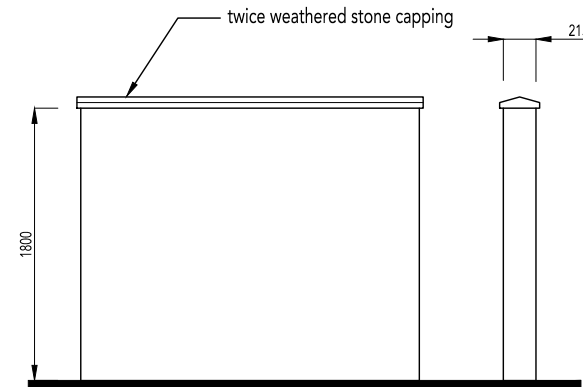

1800mm High Screen Wall

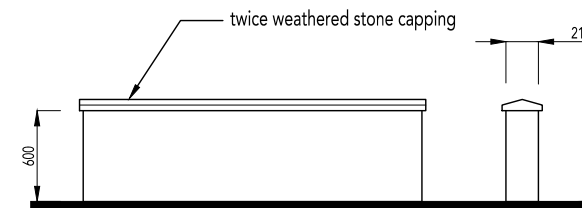

600mm High Screen Wall