

Dorchester Group

Heyford Park

Supplementary Transport Report

FINAL

Project Ref: 23824/004

Doc Ref: R23824/001/TA/rev0

October 2010

Peter Brett Associates LLP
Caversham Bridge House
Waterman Place
Reading
Berkshire
RG1 8DN
T: 0118 9500761
F: 0118 9597498
E: reading@peterbrett.com



This page is intentionally blank

Document Control Sheet

Project Name: Heyford Park
Project Ref: 23824/004
Report Title: Supplementary Transport Report
Doc Ref: R23824/001/TA/rev0
Date: October 2010

| | Name | Position | Signature | Date |
|--|-----------------|---------------------|-----------|------|
| Prepared by: | Dawn Wylie | Associate | | |
| Reviewed by: | Richard Latcham | Divisional Director | | |
| Approved by: | Keith Mitchell | Partner | | |
| For and on behalf of Peter Brett Associates LLP | | | | |

| Revision | Date | Description | Prepared | Reviewed | Approved |
|----------|------|-------------|----------|----------|----------|
| | | | | | |
| | | | | | |
| | | | | | |
| | | | | | |

Peter Brett Associates LLP disclaims any responsibility to the Client and others in respect of any matters outside the scope of this report. This report has been prepared with reasonable skill, care and diligence within the terms of the Contract with the Client and generally in accordance with the appropriate ACE Agreement and taking account of the manpower, resources, investigations and testing devoted to it by agreement with the Client. This report is confidential to the Client and Peter Brett Associates LLP accepts no responsibility of whatsoever nature to third parties to whom this report or any part thereof is made known. Any such party relies upon the report at their own risk.

This page is intentionally blank

Contents

| | | |
|----------|---|----------|
| 1 | Introduction | 1 |
| 2 | Changes to the consented scheme | 2 |
| 3 | Traffic Generation | 3 |
| 4 | Transport infrastructure | 5 |
| | Camp Road | 8 |
| | Retention of bungalows & related highway layout | 9 |
| | Pedestrian & Cyclists | 9 |
| | HGV access | 11 |
| | Bus service | 13 |

Tables

| | |
|--|---|
| Table 1 – AM difference in Trip Generation | 4 |
| Table 2 – PM difference in Trip Generation | 4 |

Figures

| | |
|--|----|
| Figure 1: Wider Context | 1 |
| Figure 3: Future Zones | 7 |
| Figure 4: Pedestrian and Cycle Routes | 10 |
| Figure 6: Example Details Bus Route One Way Zone | 14 |
| Figure 7: Public Transport | 15 |

Appendices

Outline layout of the proposed range of treatments along Camp Road

Heyford Park
Supplementary Transport Report

1 Introduction

- 1.1 Heyford Park is located on the site of the former RAF Upper Heyford, which lies in a rural area of Oxfordshire approximately 20km due north of Oxford.
- 1.2 The site is located within a network of predominately country roads, many of which are unclassified, although Junction 10 on the M40 motorway is located 6km to the east and the A4260 Banbury to Oxford Road runs from north to south some 6km to the west.
- 1.3 The nearest railway stations are at Lower Heyford (4km from the site) and Bicester. Bus routes serve the site linking to Bicester.
- 1.4 In August 2007 Ove Arup & Partners Ltd prepared a Transport Assessment (hereafter referred to as 'the TA') to support a planning application for development at Heyford Park.
- 1.5 The application area included the Flying Field employment area and the Settlement Area to the south of the flying field and that application was granted consent on 11 January 2010. The site in its wider context can be seen at **FIGURE 1** below.

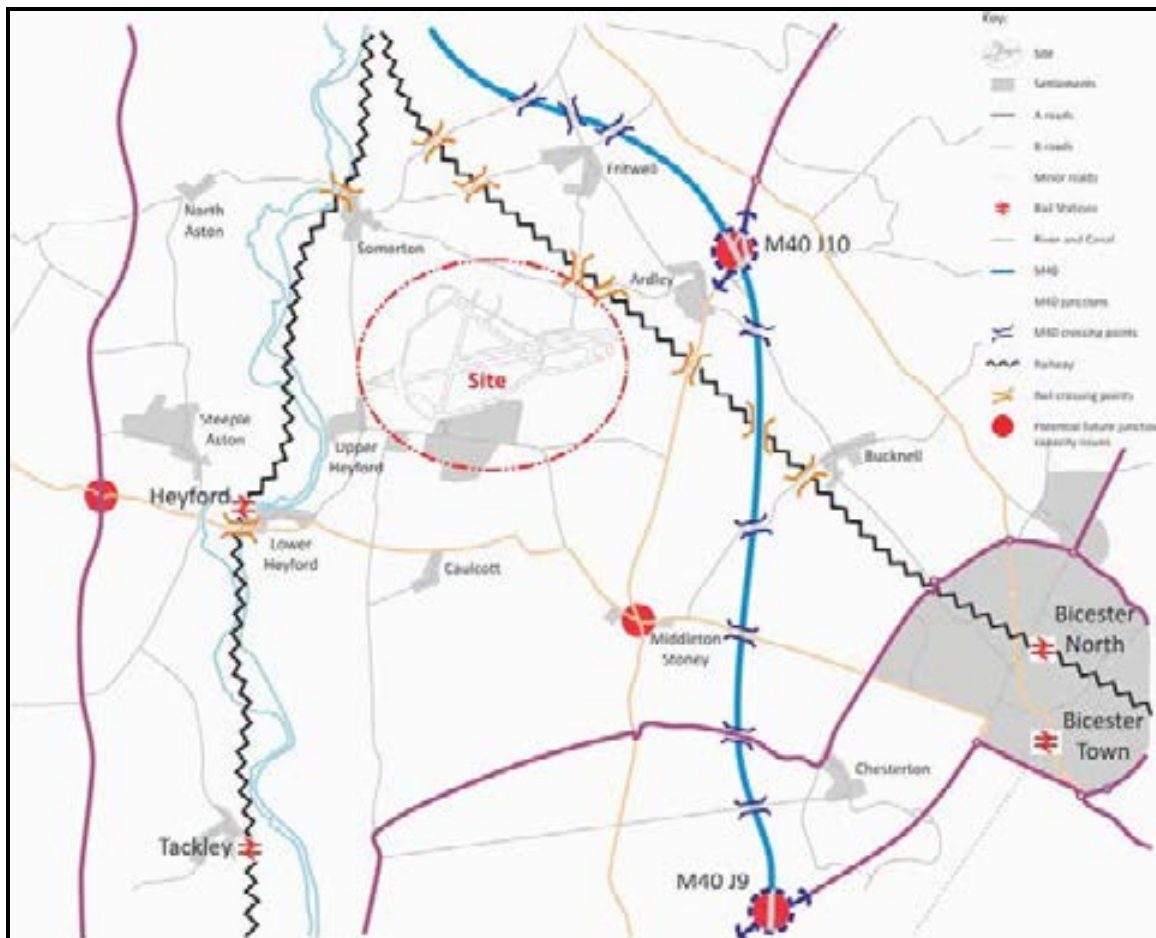


Figure 1: Wider Context

Heyford Park

Supplementary Transport Report

- 1.6 A new application is now being submitted which includes some minor amendments within the Settlement Area only. It is considered that the amendments make no material difference to the original application and as such the TA remains valid. This document, which comprises a supplement to the TA, therefore provides additional transport information relating to the areas which have changed from the consented scheme.

2 Changes to the consented scheme

- 2.1 In the TA, the development content was divided into 'Assessed Land uses' (C3, B1, B2, B8, Heritage Centre & Conference Centre) and 'Non-Trip Generating Land Uses'.
- 2.2 The TA included in its 'Assessed Land uses' the following:
- Residential – up to 1,075 dwellings;
 - B1 Office – 15,658m²;
 - B2 Office – 17,996m²;
 - B8 Storage – 86,113m²;
 - Heritage Centre – 4,195m²; and
 - Conference Centre – 4,150m².
- 2.3 The TA also discussed a number of other land uses for which it stated that no trips were included in the assessment (because it was assumed that for these uses the trips would either be internal or pass-by). The land uses that were deemed to be non trip-generating included:
- Retail – 743m²;
 - Church – 680m²;
 - Community Centre – 580m²;
 - Bar / Restaurant – 340m²;
 - Nursery – 224m²; and
 - Primary School – 2.2 ha.

- 2.4 The main changes between the current proposed Development and the consented scheme are that:
- this application only refers to the buildings and proposed development in the Settlement Area (i.e. it excludes the Flying Field);
 - 313 existing bungalows and houses are retained, rather than being demolished and rebuilt (which was the case in the consented scheme);
 - the internal street layout has changed to accommodate the bungalow and house retention; and
 - some land uses have changed slightly. Of note, the area of B1 Office use has been reduced by 4,512 SQM whilst the area of A1 Retail use increased by 657 SQM and the C1/C2 uses increased by 1,662 SQM.

3 Traffic Generation

- 3.1 The traffic generation associated with the consented scheme was considered acceptable, subject to the following works to mitigate the limited off site impact:
- An increased frequency of buses to destinations beyond the settlement;
 - Improvements at two junctions on the surrounding road system, at Middleton Stoney and the M40 junction 10; and
 - Improvements to rural footpath connections around the settlement area, reinstating some that were interrupted by the construction of the airfield.
- 3.2 The following assessment addresses any changes in level of overall traffic generation associated with the changes in land use from that in the consented scheme.
- 3.3 Where available, trip rates from the TA are used, but in the case of retail where no trip rates were quoted, trip rates have been used from TRICS version [2010\(b\)v6.6.2](#) for 'local shops on weekdays'.
- 3.4 **TABLE 1** and **TABLE 2** below summarise the differences in building schedule within the settlement area only for the consented scheme compared with the current application, together with the associated traffic generation. The tables show that the reduction in B1 is offset by the increase in retail and C1/C2. This results in an overall increase of 9 additional trips in the AM peak and an additional 17 in the PM peak.
- 3.5 This equates to a maximum of one additional vehicle every 4 minutes and is less than the typical daily variation in traffic volume. It is therefore concluded that the junction capacity analysis within the TA remains robust.

Heyford Park
Supplementary Transport Report

| | | Retail | B1 | C1/C2 |
|--------------------------|-------------------------|---------------|--------------|--------------|
| Development | Consented Scheme (SQM) | 743 | 10333 | 4020 |
| | Revised Scheme (SQM) | 1400 | 5821 | 5682 |
| | Difference (SQM) | 657 | -4512 | 1662 |
| Trip Rates (AM) | Arrivals | 0.05836 | 0.0181 | 0.01 |
| | Departures | 0.05468 | 0.0028 | 0.006111 |
| | Total | 0.11304 | 0.0209 | 0.016111 |
| Difference in trips (AM) | Arrivals | 38 | -82 | 17 |
| | Departures | 38 | -13 | 10 |
| | Total | 77 | -94 | 27 |
| NET TOTAL (AM) | | 9 | | |

Table 1 – AM difference in Trip Generation

| | | Retail | B1 | C1/C2 |
|--------------------------|-------------------------|---------------|--------------|--------------|
| Development | Consented Scheme (SQM) | 743 | 10333 | 4020 |
| | Revised Scheme (SQM) | 1400 | 5821 | 5682 |
| | Difference (SQM) | 657 | -4512 | 1662 |
| Trip Rates (PM) | Arrivals | 0.06709 | 0.0042 | 0.006111 |
| | Departures | 0.06617 | 0.0162 | 0.006667 |
| | Total | 0.13326 | 0.0204 | 0.012778 |
| Difference in trips (PM) | Arrivals | 44 | -19 | 10 |
| | Departures | 43 | -73 | 11 |
| | Total | 88 | -92 | 21 |
| NET TOTAL (PM) | | 17 | | |

Table 2 – PM difference in Trip Generation

4 Transport infrastructure

- 4.1 The revised application has provided the opportunity to improve the connectivity through the site and improve the traffic calming features along Camp Road. Observing the existing layout, it can be seen that the site is set out in distinct land uses, see **FIGURE 2** overleaf and the proposals aim to mirror this as much as possible and identify the desire lines for connectivity between those distinct land uses, see **FIGURE 3** overleaf.

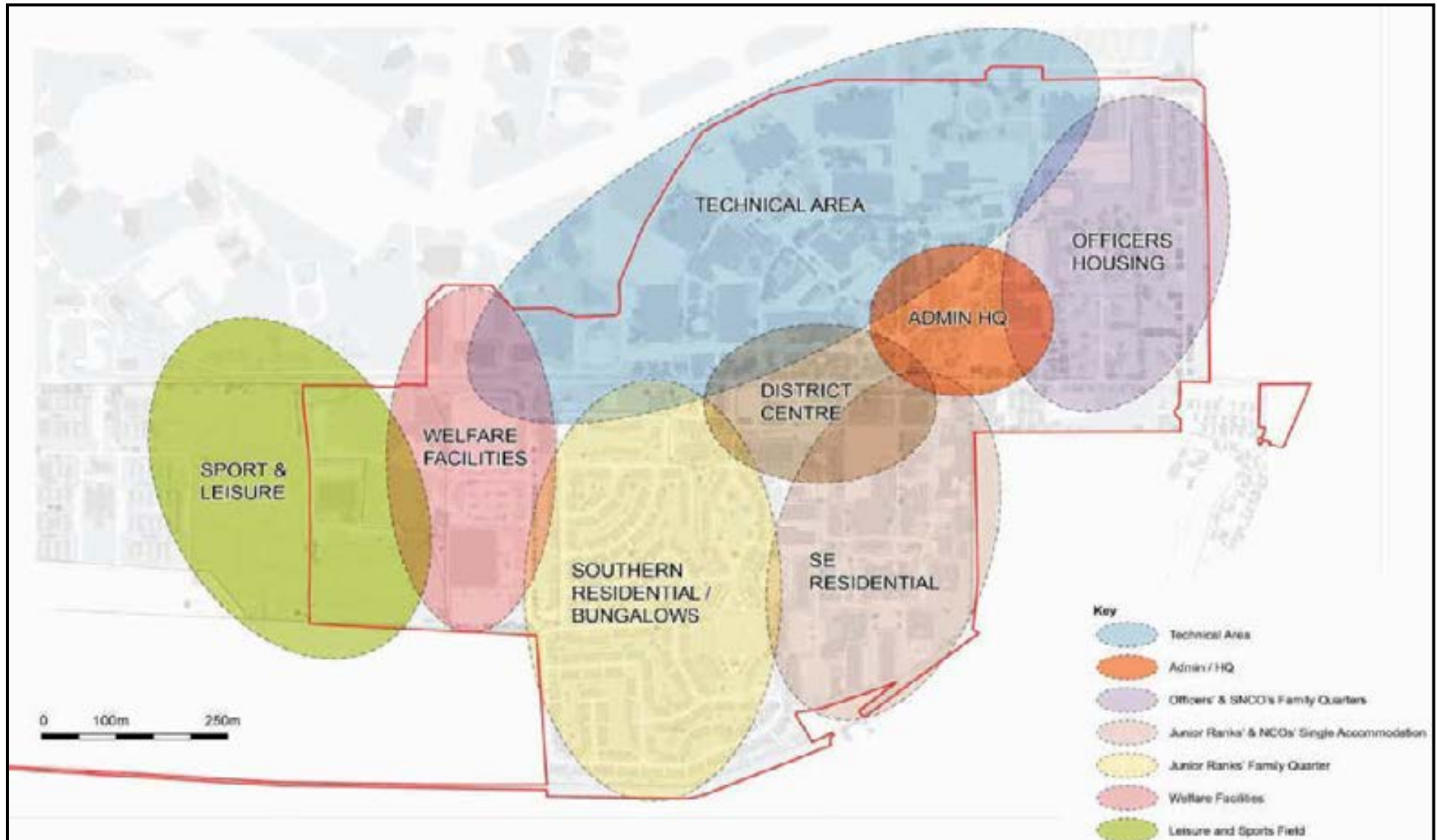


Figure 2: Existing Site Layout

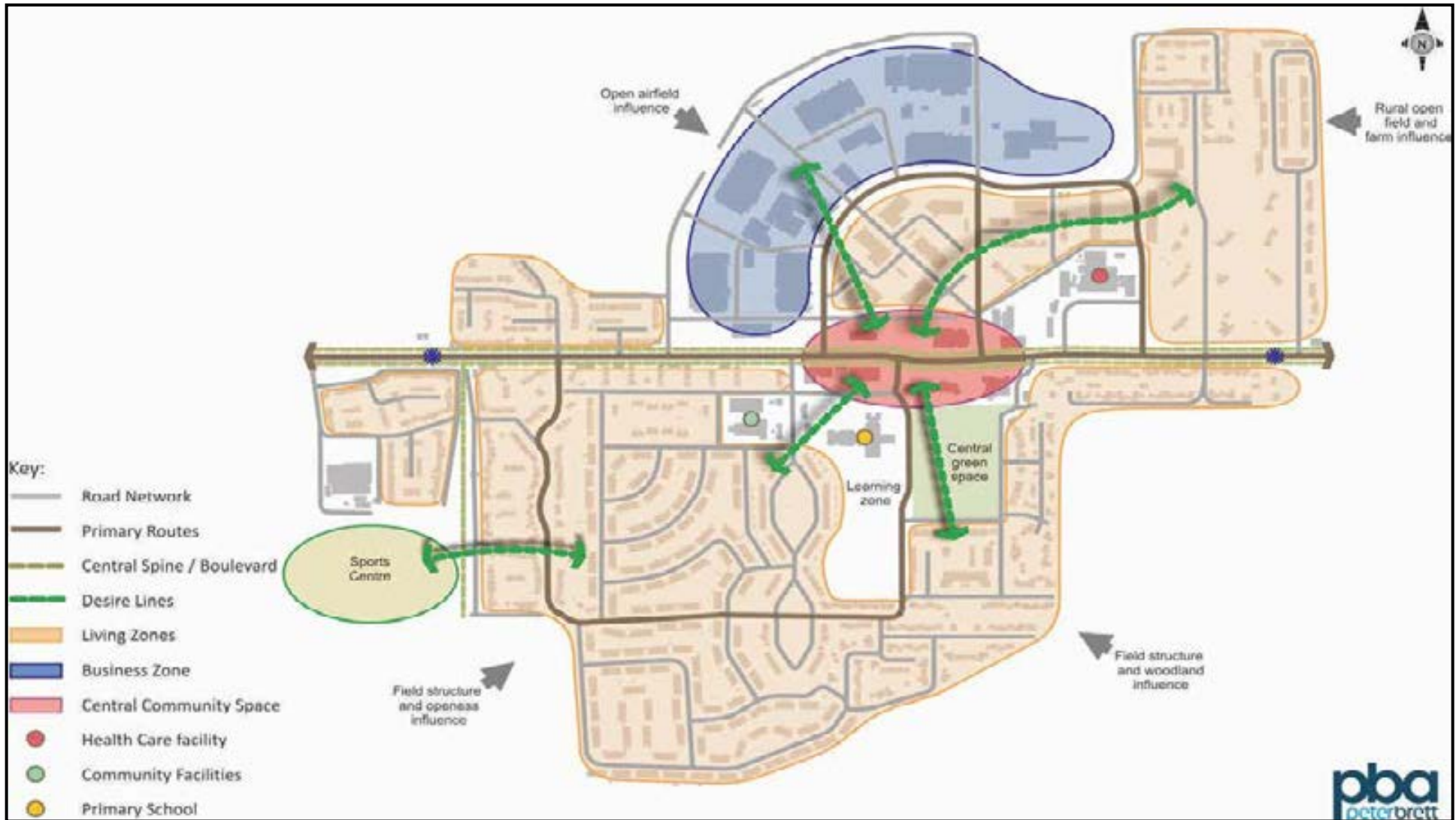


Figure 3: Future Zones

Heyford Park

Supplementary Transport Report

4.2 The main features of the principal roads are:

- Camp Road is retained as the main through route, linking the neighbourhood to the surrounding area.
- Main streets are extended from Camp Road at Dacey Drive and the Main Gate to serve residential areas.
- A new east-west street is created that links Dacey Drive to the barracks area to complete the principal street grid south of Camp Road and to provide a bus link through the existing residential area.
- A new main road extends northwards from Camp Road, beside the former Officers' Mess, which brings the main heavy business traffic into the business area via the Innovation Centre. HGVs will therefore no longer need to travel along the full length of Camp Road to gain access to the flying field.

4.3 The general approach taken for the street design in the design process has been for Camp Road to act as an integrating spine, pulling together north & south settlement areas. Further details are set out in the Design and Access Statement which accompanies the planning application. In summary, the principal transport elements remain unchanged from those set out in the TA.

4.4 For clarification, some of the principal transport infrastructure design approaches are set out below.

Camp Road

4.5 Camp Road will remain as the main vehicular route to the settlement area. Measures will be taken to mitigate its impact as a busy through route that divides the site, including proposals which seek to provide more balance of residential development each side of Camp Road and to strengthen the function of the local centre

4.6 At present Camp Road relies on build-outs to create stopping points with single direction priority at a number of locations through the developed area.

4.7 In the masterplan it is proposed that the street design will include a range of traffic calming techniques incorporated within the overall scheme to promote a sense of urban activity to discourage speed.

4.8 It is also proposed that priority will be given to pedestrian movement throughout the development and roundabouts will be replaced with managed junctions.

4.9 This will include distinct areas of street trees, landscaping, horizontal and vertical shifts in direction, bus stopping facilities and on-street car parking.

4.10 Options were considered to redirect traffic from Camp Road through the central district area onto parallel routes on its north or south sides as a more radical speed attenuation measure. On balance, it was judged that this would affect areas within the neighbourhood, extending the effects of through traffic, and that the strength of the Camp Road alignment is a fundamental characteristic of Heyford Park which the design should work with. An outline layout of the proposed range of treatments along Camp Road can be found at **APPENDIX A**.

Retention of bungalows & related highway layout

- 4.12 Within the main structural street grid is the network of interconnected minor streets that serve the majority of the development. The existing street pattern will be retained where possible, but some new street connections are required, - specifically on the proposed bus route which will run through both existing and proposed residential areas, as the road in this area may need to be upgraded to adoptable standards.
- 4.13 Generally, a lattice street pattern has been devised to reflect existing layouts and to suit the new residential layout and protect mature trees, giving a comprehensive access network throughout the neighbourhood. The settlement area includes a number of street design measures that integrate good movement and access with other features, including:
- Changes in street surfaces to indicate changing road-user priorities;
 - Footpaths alongside the main routes, separated by green verges in many instances;
 - Shared surface areas where pedestrians have clear priority over vehicles;
 - Car parking in small areas under high levels of supervision from surrounding houses; and
 - Similarly, parking for community facilities in groups to provide choice and convenience for access, and reduced visual impact of parking areas.
- 4.15 Each street has the potential to be unique by virtue of its alignment and the containment afforded by buildings, with traffic speeds being reduced through design rather than signage. In addition, the proposals are for a simple palette of high quality materials to be used for all new streets.

Pedestrian & Cyclists

- 4.16 The lattice street structure creates a permeable layout that allows movement through the development. This promotes walking and cycling, and all new streets will be designed in detail to allow safe use on dedicated paths or shared surfaces. The main points include:
- The landscape belt alongside Camp Road which will include a safe cycling and walking route that will be well separated from the traffic.
 - A strong east-west axis through the neighbourhood centre which picks up all the main facilities and extends into the street pattern.
 - A strong north-south axis through Carswell Circle and the neighbourhood centre, which crosses Camp Road at designated crossing points to link with routes on the north side.
- 4.17 The main pedestrian and cycle routes, are shown in **FIGURE 4** overleaf.

Heyford Park
Supplementary Transport Report

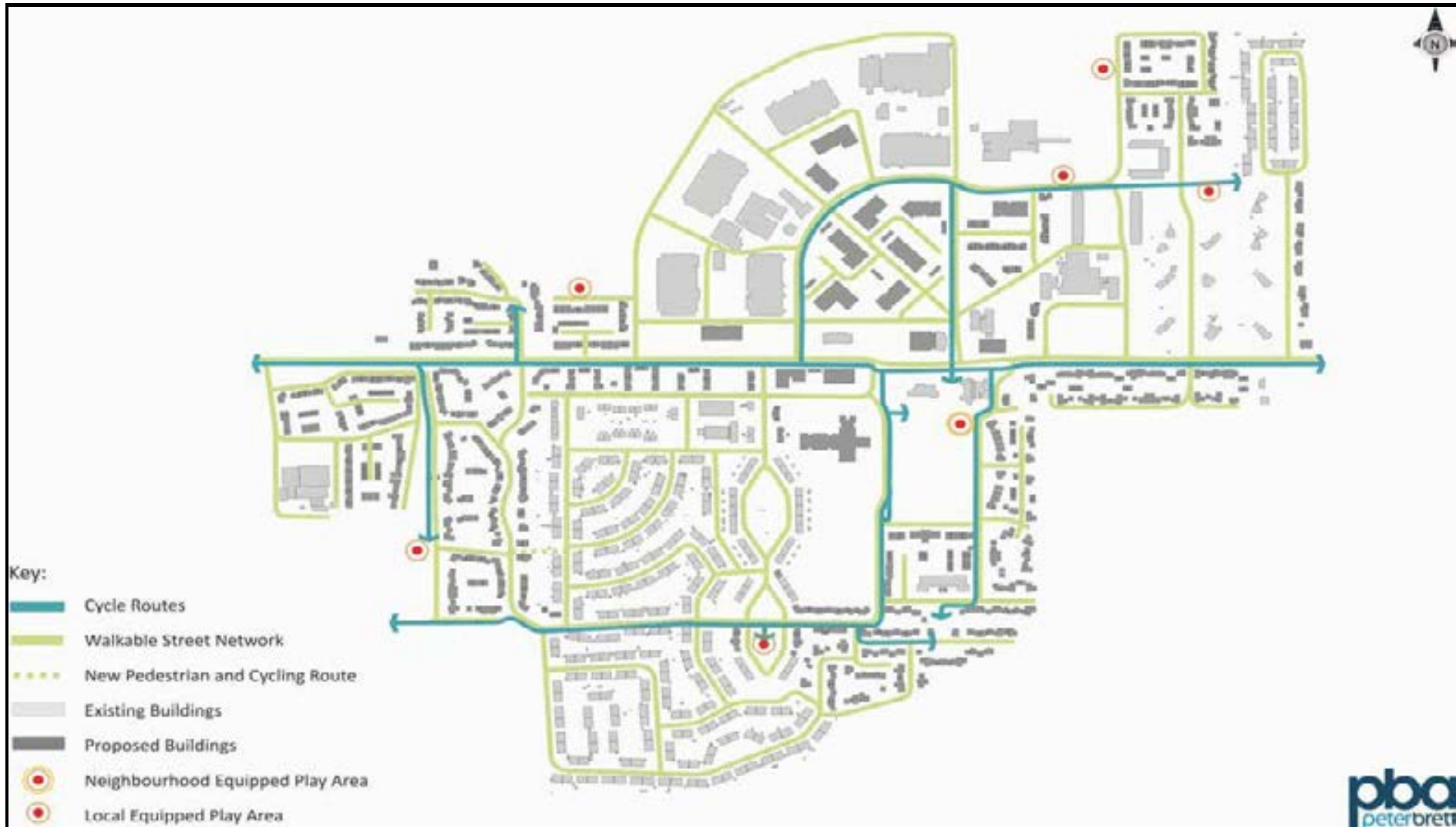


Figure 4: Pedestrian and Cycle Routes

HGV access

- 4.18 The current HGV access to the former Flying Field lies to the west of the main Heyford Park access towards Upper Heyford. However, the majority of HGV traffic originates from the strategic road network to the east. Following residential development in the Heyford Park area, clearly a reduction of heavy traffic along Camp Road within the settlement would be desirable, but business traffic also needs to be separated as far as possible from residential traffic associated with the proposed residential development north of Camp Road.
- 4.19 A Management Plan for the Flying Field sets out in detail how access will be provided and maintained to the employment areas on the former Flying Field. The following key points have been taken into consideration from this Management Plan:
- Businesses in buildings on the Flying Field require access for goods and deliveries, often by HGVs, and for employees;
 - The Flying Field is very extensive, so that vehicular rather than pedestrian access is more practical in most cases albeit that a detailed transport strategy has been drawn up to encourage the use of sustainable modes of transport as much as possible; and
 - An attractive aspect of the location for many existing businesses is the secure nature of the site, and their preference would be to have minimal access points with a high degree of control over movements.
- 4.20 The proposed HGV access off Camp Road broadly follows the same alignment as in the consented scheme and this separates business traffic from the residential traffic (which will access the northern residential areas from the existing main access), whilst at the same time effectively removing HGV traffic from the centre of the settlement.
- 4.21 The proposal is for vehicular access to the Flying Field area through a security control. In addition, a one-way circular route has been devised around the Flying Field giving access to all buildings with the only exit being through the gated security control.
- 4.22 The main access at the Trident will have the southern west-east link closed to vehicular traffic. Therefore, delivery vehicles for the retail units fronting Camp Road will access the rear of the retail buildings from the western end, maintaining the separation of residential and commercial traffic and creating a low trafficked space at the existing main entrance, serving residential areas only.
- 4.23 **FIGURE 5** shows the main routes for HGV and service vehicles.



Figure 5: Principal Movement Structure

Bus service

- 4.24 Heyford Park lies on bus route 25 to Bicester and Oxford. The existing bus stop is near the existing shop.
- 4.25 The proposals include a bus route with stopping facilities looping through the existing and proposed residential area to the south of Camp Road (as opposed to the consented scheme, where the bus route would have traversed new residential areas only because there were no retained residential areas). The introduction of a new route will provide bus stops within 400m walk of all dwellings, providing enhanced access to bus services to existing residents and employees, thereby aiding social inclusion and providing an alternative choice of transport to help reduce car-based traffic. Improvements will also be made to the frequency of the existing service.
- 4.26 A one way section of road will be introduced through the existing residential area, as the existing highway is not wide enough to accommodate two-way bus operation. This is in keeping with a number of one way streets in that area. The section of road, although not wide enough for two buses, is wide enough for two way cars, so in order to discourage illegal manoeuvres through that section of road, traffic calming measures similar to those on Camp Road will be introduced. These will include the introduction of chicane on-street parking and landscaping features, see **FIGURE 6** overleaf.
- 2.27 New shelters will also be located along Camp Road in the neighbourhood centre adjacent to the proposed retail area.
- 4.28 The public transport routes and stops are shown at **FIGURE 7** overleaf.

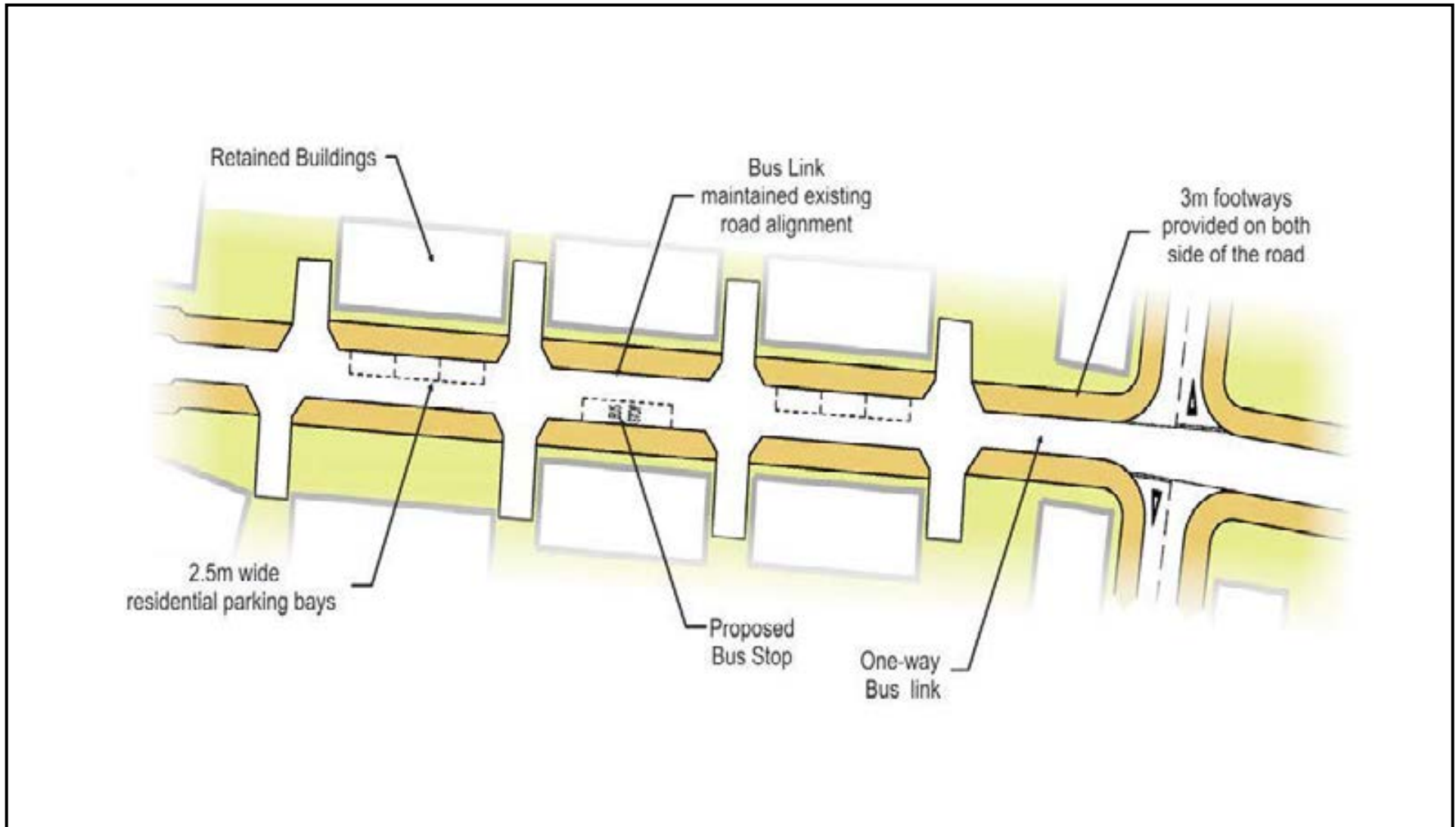


Figure 6: Example Details Bus Route One Way Zone

Heyford Park
Supplementary Transport Report

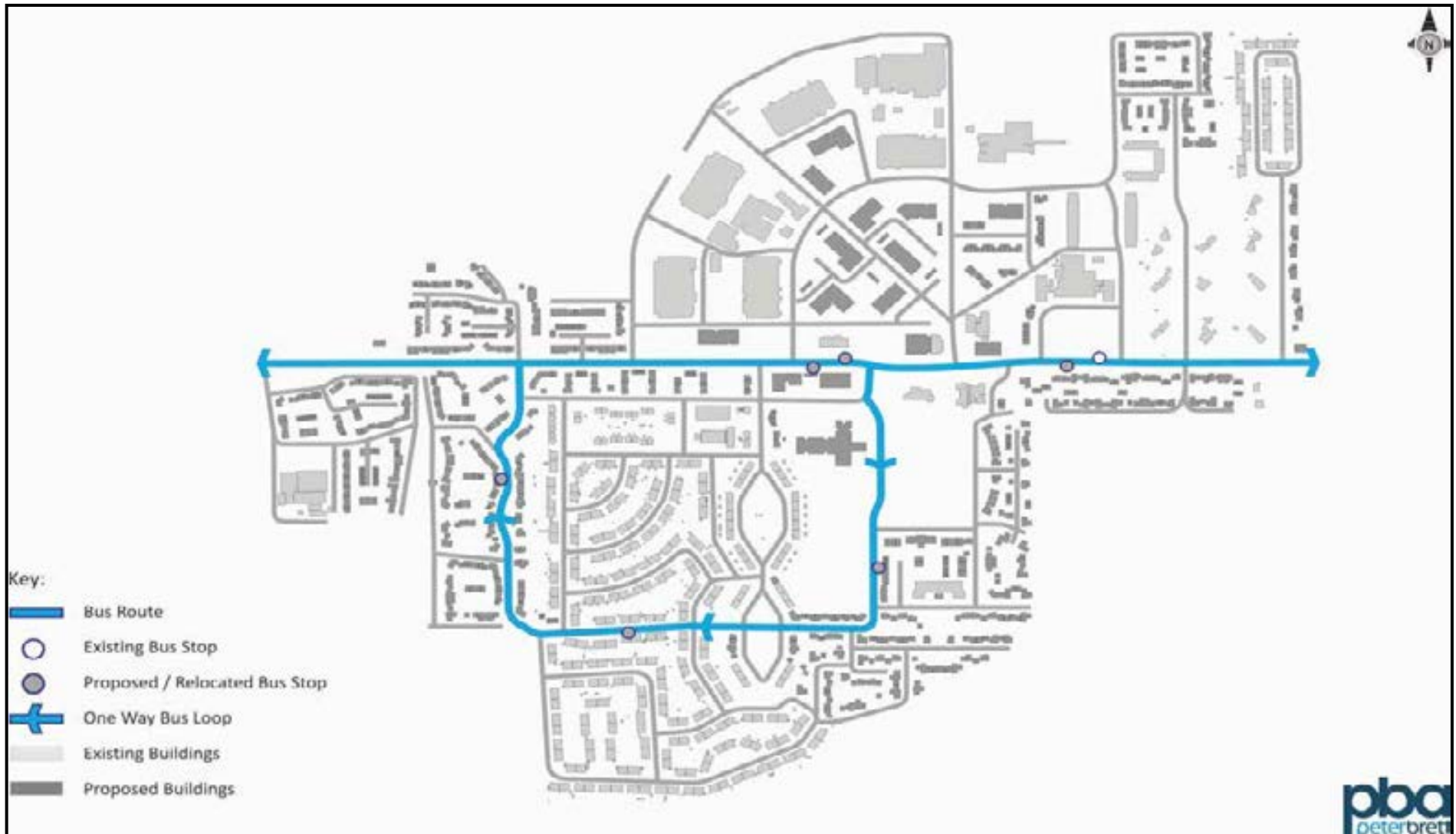


Figure 7: Public Transport

North Oxfordshire
Consortium

Heyford Park

Transport Assessment

ARUP

North Oxfordshire
Consortium

Heyford Park

Transport Assessment

August 2007

Ove Arup & Partners Ltd

The Arup Campus, Blythe Gate, Blythe Valley Park, Solihull, West Midlands. B90 8AE
Tel +44 (0)121 213 3000 Fax +44 (0)121 213 3001
www.arup.com

This report takes into account the particular instructions and requirements of our client.

It is not intended for and should not be relied upon by any third party and no responsibility is undertaken to any third party

Job number 120669

| | | | |
|-----------|--------------|------------|--------|
| Job title | Heyford Park | Job number | 120669 |
|-----------|--------------|------------|--------|

| | | | |
|----------------|----------------------|----------------|--|
| Document title | Transport Assessment | File reference | |
|----------------|----------------------|----------------|--|

Document ref

| Revision | Date | Filename | 0001TA Draft 1_IGC_18.10.06.doc | | |
|----------|----------|-------------|---|------------|--------------|
| Draft 1 | 23/02/07 | Description | First draft | | |
| | | | Prepared by | Checked by | Approved by |
| | | Name | Ian Clarke | Ian Clarke | Johnny Ojeil |
| | | Signature | | | |
| Draft 2 | 16/03/07 | Filename | 0002TA Draft 2_IGC_16.03.07.doc | | |
| | | Description | Includes traffic data | | |
| | | | Prepared by | Checked by | Approved by |
| | | Name | Ian Clarke | Ian Clarke | Johnny Ojeil |
| | | Signature | | | |
| Draft 3 | 12/06/07 | Filename | 0003TA Draft 3_IGC_12.06.07.doc | | |
| | | Description | Re-worked with revised development content | | |
| | | | Prepared by | Checked by | Approved by |
| | | Name | Ian Clarke | Ian Clarke | Johnny Ojeil |
| | | Signature | | | |
| Draft 4 | 14/08/07 | Filename | 0004TA Draft 4_IGC_27.7.07.doc | | |
| | | Description | Incorporating clarifications received re: travel plan and parking | | |
| | | | Prepared by | Checked by | Approved by |
| | | Name | Ian Clarke | Iain Dick | Johnny Ojeil |
| | | Signature | | | |

Issue Document Verification with Document

| | | |
|-----------|--------------|------------|
| Job title | Heyford Park | Job number |
| | | 120669 |

| | | |
|----------------|----------------------|----------------|
| Document title | Transport Assessment | File reference |
|----------------|----------------------|----------------|

Document ref

| | | | | | |
|----------|----------|-------------|---|--|---|
| Revision | Date | Filename | 0005TA Issued_IGC_15.8.07.doc | | |
| Issue | 15/08/07 | Description | Incorporating Jon 10 and Middleton Stoney proposed mitigation. Summary finalised. Final minor amendments. | | |
| | | | Prepared by | Checked by | Approved by |
| | | Name | Ian Clarke | Iain Dick | Johnny Ojeil |
| | | Signature |  |  |  |
| | | Filename | | | |
| | | Description | | | |
| | | | Prepared by | Checked by | Approved by |
| | | Name | | | |
| | | Signature | | | |
| | | Filename | | | |
| | | Description | | | |
| | | | Prepared by | Checked by | Approved by |
| | | Name | | | |
| | | Signature | | | |

Issue Document Verification with Document

Contents

| | Page | |
|---|---|----|
| 1 | Introduction | 1 |
| | 1.1 Structure of the Report | 1 |
| 2 | The Site and Surrounding Road Network | 3 |
| | 2.1 Site Location | 3 |
| | 2.2 History and Existing use | 3 |
| | 2.3 Highway Network | 3 |
| 3 | Existing Traffic Conditions | 5 |
| | 3.1 Data Collection | 5 |
| | 3.2 Origin/Destination data | 6 |
| | 3.3 Existing traffic | 7 |
| 4 | Planning & Policy Framework | 9 |
| | 4.1 Policy Framework | 9 |
| | 4.2 National Planning Policy Guidance - PPG13 Transport | 9 |
| | 4.3 Regional Transport Strategy | 9 |
| | 4.4 Structure/Local Plan & Development Framework | 10 |
| | 4.5 Local Transport Plan | 10 |
| 5 | Proposed Development | 13 |
| | 5.1 Development content | 13 |
| | 5.2 Access arrangements | 13 |
| | 5.3 Parking | 13 |
| 6 | Traffic Impact | 15 |
| | 6.1 Design years | 15 |
| | 6.2 Traffic flows | 15 |
| | 6.3 Committed Development | 15 |
| | 6.4 Distribution | 16 |
| | 6.5 Scope of Junction Assessments | 16 |
| | 6.6 HGV Routing Agreement | 16 |
| 7 | 2006 Base Traffic | 17 |
| | 7.1 B4030 Lower Heyford Road – Port Way | 17 |
| | 7.2 B430 Ardley Road – Unnamed Road towards Camp Road | 17 |
| | 7.3 Camp Road – Unnamed Road towards B430 | 18 |
| | 7.4 Camp Road – Kirtlington Road | 19 |
| | 7.5 Camp Road - Somerton Road | 19 |
| | 7.6 B4030 with the B430 at Middleton Stoney | 20 |
| | 7.7 Summary of 2006 Base Year Junction Performance | 20 |
| 8 | 2013 Base Year Traffic | 21 |

| | | |
|------|--|----|
| 8.1 | B4030 Lower Heyford Road – Port Way | 21 |
| 8.2 | B430 Ardley Road – Unnamed Road towards Camp Road | 22 |
| 8.3 | Camp Road – Unnamed Road towards B430 | 22 |
| 8.4 | Camp Road – Kirtlington Road | 23 |
| 8.5 | Camp Road - Somerton Road | 23 |
| 8.6 | B4030 with the B430 at Middleton Stoney | 24 |
| 8.7 | Summary of 2013 Base Year Junction Performance | 24 |
| 9 | Trip generation | 25 |
| 9.1 | Residential | 25 |
| 9.2 | Employment | 25 |
| 9.3 | Trip Rates from Existing Land Uses | 26 |
| 10 | 2013 Opening Year Traffic | 29 |
| 10.1 | B4030 Lower Heyford Road – Port Way | 29 |
| 10.2 | B430 Ardley Road – Unnamed Road towards Camp Road junction | 29 |
| 10.3 | Camp Road – Unnamed Road towards B430 | 30 |
| 10.4 | Camp Road – Kirtlington Road | 31 |
| 10.5 | Camp Road - Somerton Road | 31 |
| 10.6 | B4030 with the B430 at Middleton Stoney | 32 |
| 10.7 | Summary of Opening Year Junction Performance | 34 |
| 10.8 | Sensitivity Test | 34 |
| 11 | M40 Motorway Junction 10 (B430 roundabout) | 39 |
| 11.1 | Junction Analysis | 39 |
| 11.2 | Design years | 39 |
| 11.3 | Traffic flows | 39 |
| 11.4 | 2013 Base Year Traffic | 39 |
| 11.5 | 2013 Opening Year Traffic | 40 |
| 11.6 | 2028 Base Year Traffic | 41 |
| 11.7 | 2028 Full Development Traffic | 41 |
| 12 | Site Access | 43 |
| 12.1 | Junctions on Camp Road | 43 |
| 12.2 | Junction Tests | 44 |
| 12.3 | Summary | 47 |
| 13 | Accidents | 49 |
| 13.1 | Area | 49 |
| 13.2 | Methodology | 49 |
| 13.3 | Accident Data | 49 |
| 13.4 | Analysis | 50 |
| 13.5 | Accidents Involving Vulnerable Road Users | 51 |

| | | | |
|----|------|---|----|
| | 13.6 | Conclusions | 52 |
| 14 | | Village Traffic Calming | 53 |
| | 14.1 | Existing Traffic Calming | 53 |
| | 14.2 | Additional Traffic Calming | 53 |
| 15 | | Public Transport, Walking and Cycling | 55 |
| | 15.1 | Bus Services | 55 |
| | 15.2 | Bus Service Improvements | 56 |
| | 15.3 | Rail Services | 56 |
| | 15.4 | Rail Service Improvements | 56 |
| | 15.5 | Pedestrian and Cycle Facilities | 56 |
| | 15.6 | Pedestrian and Cycle Improvements | 57 |
| 16 | | Travel Plan | 59 |
| | 16.1 | Introduction | 59 |
| | 16.2 | Existing Travel Patterns | 59 |
| | 16.3 | Policy Background | 59 |
| | 16.4 | Travel Plan Management Structure | 60 |
| | 16.5 | Travel Plan Coordinator | 60 |
| | 16.6 | Development of the Travel Plan | 61 |
| | 16.7 | Objectives, Targets and Monitoring | 62 |
| | 16.8 | Data Gathering Tools | 63 |
| | 16.9 | Travel Plan Measures | 64 |
| 17 | | Construction Issues | 69 |
| | 17.1 | Outline Planning Application | 69 |
| | 17.2 | Construction Traffic Routes | 69 |
| | 17.3 | On-Site Traffic and Pedestrian Movement | 69 |
| | 17.4 | Site Earthworks and Remediation | 69 |
| | 17.5 | Construction and Demolition Waste | 69 |
| 18 | | Appraisal of Impacts | 71 |
| | 18.1 | Appraisal Summary Table | 71 |
| 19 | | Summary and Conclusions | 73 |

Figures

Figure 1 Heyford Park and Local Road Network

Figure 2 Existing Accesses to Heyford Park

Figure 3 Highway Network Traffic Survey Locations

Figure 4 Camp Road Survey Locations

Figure 5 Existing Traffic Flows - Average Weekday AM

Figure 6 Existing Traffic Flows - Average Weekday PM

Figure 7 Traffic Flows - Average Weekday 2006 Base AM

Figure 8 Traffic Flows - Average Weekday 2006 Base PM

Figure 9 Traffic Flows - Average Weekday 2013 Base AM

- Figure 10 Traffic Flows - Average Weekday 2013 Base PM
- Figure 11 Traffic Flows - Average Weekday 2013 Base + Generated AM
- Figure 12 Traffic Flows - Average Weekday 2013 Base + Generated PM
- Figure 13 Junction 10 Traffic Flows - Average Weekday 2006 Base AM
- Figure 14 Junction 10 Traffic Flows - Average Weekday 2006 Base PM
- Figure 15 Junction 10 Traffic Flows - Average Weekday 2013 Base AM
- Figure 16 Junction 10 Traffic Flows - Average Weekday 2013 Base PM
- Figure 17 Junction 10 Traffic Flows - Average Weekday 2013 Base + Generated AM
- Figure 18 Junction 10 Traffic Flows - Average Weekday 2013 Base + Generated PM
- Figure 19 Junction 10 Traffic Flows - Average Weekday 2028 Base AM
- Figure 20 Junction 10 Traffic Flows - Average Weekday 2028 Base PM
- Figure 21 Junction 10 Traffic Flows - Average Weekday 2028 Base + Generated AM
- Figure 22 Junction 10 Traffic Flows - Average Weekday 2028 Base + Generated PM
- Figure 23 Agreed Junctions for Testing
- Figure 24 Traffic Flows - Average Weekday 2013 Base + Generated AM SENSITIVITY
- Figure 25 Traffic Flows - Average Weekday 2013 Base + Generated PM SENSITIVITY
- Figure 26 Camp Road Accesses to Development 1: Dacey Drive
- Figure 27 Camp Road Accesses to Development 2: Dow Street
- Figure 28 Camp Road Accesses to Development 3: Main Gate
- Figure 29 Camp Road Accesses to Development 4: HGV Access
- Figure 30 Camp Road Accesses to Development 5: Larsen Road
- Figure 31 Personal Injury Accidents Location Plan
- Figure 32 Bus Routes Serving Heyford Park
- Figure 33 Heyford Park Accesses: Traffic Flows - Average Weekday 2013 Base + Generated AM
- Figure 34 Heyford Park Accesses: Traffic Flows - Average Weekday 2013 Base + Generated AM
- Figure 35 Proposed Alterations to Junction between B4030 and B430 at Middleton Stoney
- Figure 36 Junction 10: Proposed Carriageway Marking Alterations

Appendices

Appendix A

Transport Assessment Scoping Note

Appendix B

Census Data

Appendix C

Technical Note: Methodology for Applying Distribution

Appendix D

Local Highway Network: Junction Analyses

Appendix E

M40 Junction 10: Junction Analyses

Appendix F

Camp Road: Junction Analyses

Appendix G

Accident Records

Appendix H

NRTF/TEMPRO Traffic Growth Calculations

Appendix I

B4030/B430 Junction at Middleton Stoney: LINSIG Analyses

1 Introduction

Arup has been commissioned by North Oxfordshire Consortium to undertake a Transport Assessment (TA) in support of an outline planning application for the proposed development of Heyford Park, which forms part of the former RAF Upper Heyford in Oxfordshire.

The TA has been prepared following discussions with the Highway Authority, Oxfordshire County Council and the Highways Agency in respect of the application and an understanding of the issues that need to be addressed arising from those discussions. A note scoping the agreed coverage of the TA was issued to key stakeholders in October 2006 and although, in agreement with Oxfordshire County Council, the scope evolved as the project proceeded, the original Scoping Note is included in **Appendix A**.

1.1 Structure of the Report

The TA is structured as follows:

Chapter 2 describes the existing site and the surrounding road network;

Chapter 3 provides an analysis of existing travel characteristics and traffic conditions;

Chapter 4 outlines the transport planning and policy background;

Chapter 5 gives details of the proposed development;

Chapter 6 provides an overview of traffic impacts associated with the proposals;

Chapter 7 provides details of the 2006 base (no development) local traffic conditions;

Chapter 8 provides details of the 2013 base (no development) local traffic conditions;

Chapter 9 describes the trip generation assumptions;

Chapter 10 gives details of the 2013 opening year (full development) local traffic impact;

Chapter 11 considers traffic impact at Junction 10 of the M40;

Chapter 12 describes the road accesses where the development links to the local network;

Chapter 13 analyses accidents in the area;

Chapter 14 discusses traffic calming in local villages;

Chapter 15 discusses public transport, walking and cycling;

Chapter 16 proposes a travel plan framework;

Chapter 17 considers construction issues;

Chapter 18 provides a brief NATA style appraisal of impacts; and

Chapter 19 provides a summary and conclusions.

Figures and Appendices are included at the end of the report.

2 The Site and Surrounding Road Network

2.1 Site Location

Heyford Park is situated on the site of the former RAF Upper Heyford, which lies in a rural area of Oxfordshire approximately 20km due north of Oxford. The closest towns are Bicester 7km south-east, Brackley 10km north-east and Banbury 15km to the north. The nearest railway stations are at Lower Heyford (4km from the site) and Bicester.

The site is located within a network of predominantly country roads, many of which are unclassified, although Junction 10 of the M40 is located 6km to the east and the A4260 Banbury to Oxford road runs from north to south some 6 km to the west.

Figure 1 shows the location of the site and the wider area. (The Built Form Masterplan and the Land Use Masterplan drawings are included in the full Environment Assessment to which this Transport Assessment is appended)

2.2 History and Existing use

Upper Heyford was an operational airfield for many years and since the nineteen sixties was used by the United States Air Force (USAF), latterly as a base for F111 bombers. At its peak, the airbase housed some 12,000 American servicemen and their families. Extensive building and other works were carried out at various periods resulting in a large site area with a great variety of infrastructure.

After a period of reduced activity in the early nineties, the airbase closed in 1994 although most of the infrastructure has been retained. Some of the former military buildings are now used for commercial purposes although many are disused and falling into dereliction. As of summer 2006 approximately 980 people are employed on the site. There are also some 391 existing residential dwellings on the site, 315 of which are occupied providing accommodation for approximately 800 residents.

2.3 Highway Network

2.3.1 Camp Road

Access to the existing settlement and proposed areas of further development are from Camp Road. This bisects the site on a generally east to west alignment. The former runway, taxiways and other facilities associated with the flying field lie to the north of Camp Road. Most of the existing commercial activity is located in this area as well as a small number of dwellings. To access the flying field, commercial traffic currently has to travel from east to west along the full length of the main development area to enter the site at the westernmost gate. There are no other access points around the airfield perimeter. Other business traffic enters the site at the Main Gate.

There are four existing access points on the north side of Camp Road. From west to east, these are:

- The Lorry Access Gate (Gate 7) predominantly provides the HGV access route to the parts of the airfield used for vehicle storage;
- The Main Gate gives access to the office and other commercial areas north of Camp Road known as the 'Trident' due to its distinctive road pattern;
- Soden Road is a cul-de-sac containing 10 large houses, formerly used as officers accommodation; and
- Larsen Road is also a cul-de-sac of approximately 40 dwellings.

On the south side of Camp Road two roads, Dacey Drive and Dow Street, provide access into the main area of existing dwellings.

In addition, there are several blocked off accesses from Camp Road to both the northern and southern areas of the site.

Where it passes through the existing development, Camp Road has an overall width of 6m but is traffic calmed in five locations by buildouts which restrict the carriageway to one-way working.

Figure 1 shows the location of the site and the wider area. Details of Camp Road and the existing site accesses are shown in **Figure 2**.

2.3.2 Wider Highway Network

At its western end, in Upper Heyford village, Camp Road terminates at a 'T' junction with the unclassified road from Lower Heyford to Somerton. To the north, beyond Somerton there are junctions with minor roads to Ardley and Fritwell, and the road eventually meets the A4260 between the villages of North Aston and Duns Tew at an uncontrolled crossroads. The A4260 runs in a general north-south alignment from Banbury to Kidlington and thence Oxford. 3km south of the North Aston/Duns Tew junction the A4260 is crossed by the B4030 at the Hopcrofts Holt signalised junction. To the west the B4030 passes through The Bartons and then to Enstone and Chipping Norton.

East of Hopcrofts Holt the B4030 crosses the River Cherwell at a single carriageway bridge with traffic signals controlling priority. Contained within the signal controlled section is a crossroads junction; the north arm leading to the villages of Steeple Aston and Middle Aston, the south arm passing Rousham Park and joining the A4260 some 3km south of Hopcrofts Holt. Proceeding east, the B4030 crosses the Banbury to Oxford railway line adjacent to Heyford Station, bypasses Lower Heyford village centre and continues to Bicester after crossing the B430 at a signalised crossroads in Middleton Stoney.

Approximately 5km north of Middleton Stoney and immediately north of the village of Ardley, the B430 terminates at Junction 10 of the M40 which also links with the A43 trunk road and the Cherwell Motorway Service Area (MSA). The B430 forms a north-south link between the M40 and the A34 trunk road at Weston-on-the-Green, which is some 5km south of Middleton Stoney. The A34 forms part of the strategic route from Southampton via Oxford to join the M40 at Junction 9 and hence to the Midlands and North. Southwards the M40 leads to London and the M25.

About halfway between Ardley and Middleton Stoney, the B430 is joined from the west by an unclassified road that links with Camp Road just to the east of the proposed Heyford Park development. Camp Road joins the unclassified road at an asymmetrical crossroads; the southern arm joins the B4030 west of Middleton Stoney. The northern arm, Chilgrove Drive, formerly provided an emergency access route to the airfield but is now blocked off and virtually unused.

Immediately west of the Heyford Park site area, a further link, Kirtlington Road (leading to Port Way), leaves Camp Road and runs southwards, crossing the B4030 at a priority junction and continuing south to join the A4095 just north of Kirtlington village. South of the village the continuation of Port Way leaves the A4095 and, after passing through the village of Bletchingdon, eventually joins the A34 some 4km south of the B430 junction at Weston-on-the-Green.

The A4095 runs in a general northeast to southwest direction from Bicester to Kirtlington, Long Hanborough and finally to Witney. It crosses the A4260 at Bunkers Hill, a staggered priority crossroads 8km south of Hopcrofts Holt and 3km north of Kidlington.

3 Existing Traffic Conditions

3.1 Data Collection

In order to establish existing traffic levels, a series of data collection surveys, agreed with the local Highway Authority were undertaken by traffic survey sub-consultant 'Count On Us' Ltd. The results from these surveys were used to construct a series of spreadsheets to illustrate existing traffic levels and allow analysis of existing junctions.

3.1.1 Local Highway Network

Classified turning counts were carried out at 12 locations on Wednesday 12th and Thursday 13th July 2006 covering the morning and evening peak hours 07.00 – 09.00hrs and 16.30 – 18.30hrs. The turning count locations are shown in Table 3.1.

Table 3.1: Classified Turning Count Locations

| Location |
|--|
| A4260 crossroads junction between Duns Tew and North Aston |
| A4260 signalised crossroads with B4030 at Hopcrofts Holt |
| A4260 staggered crossroads with A4095 at Bunkers Hill |
| B4030 at Lower Heyford – junction with minor road to Upper Heyford |
| B4030 signalised crossroads with B430 at Middleton Stoney |
| A4095 with B430 south of Middleton Stoney |
| A4095 junction with Port Way |
| B430 at Weston-on-the-Green junction with minor road to Bletchingdon |
| B430 between Middleton Stoney and Ardley – junction with minor road to Upper Heyford |
| Minor crossroads with Chilgrove Drive and the east end of Camp Road |
| Junction of Port Way and Camp Road |
| 'T' junction of Camp Road with the Lower Heyford to Somerton Road in Upper Heyford village |

Automatic Traffic Counters (ATC) were installed at 42 sites to collect supplementary data over seven days including the turning count days. The classified turning count and ATC locations are shown in **Figure 3**.

3.1.2 Camp Road

In order to obtain detailed information concerning existing through traffic on Camp Road and existing trips related to Heyford Park, 12hr (7.00hrs to 19.00hrs) manual classified turning counts were carried out at the main junctions on Camp Road and Automatic Traffic Counters were installed to cover the same period at the entrance to minor roads.

The location and type of the Camp Road surveys are listed in Table 3.2 and shown in **Figure 4**.

Table 3.2: Camp Road survey locations and type

| Location | Survey type |
|--|---------------------------------|
| the Main Gate (north side of Camp Road) | Manual Classified Turning Count |
| the Lorry Access Gate (north side of Camp Road) | Manual Classified Turning Count |
| Dacey Drive (south side of Camp Road) | Manual Classified Turning Count |
| Dow Street (south side of Camp Road) | Manual Classified Turning Count |
| Soden Road (north side of Camp Road) | Automatic Traffic Counters |
| Larsen Road (north side of Camp Road) | Automatic Traffic Counters |
| the caravan park/sewage plant opposite Larsen Road (south side of Camp Road) | Automatic Traffic Counters |

3.1.3 M40 Motorway

The Highways Agency provided AM and PM peak hour balanced traffic flows for Junction 10 of the M40. These data were derived from a 12hr survey carried out on Thursday 11th November 2004.

Some existing data was also obtained from the Highways Agency for Junction 9 of the M40. These data were somewhat limited in scope but it was found that impacts on Junction 9 were very slight and the Highways Agency and Highways Authority did not require analysis of this junction, avoiding the need for any supplementary data collection.

3.2 Origin/Destination data

Journey to Work data from the 2001 Census was obtained from the Government's Office for National Statistics. This provided details of the origins of trips to employment facilities at Heyford Park and the workplace destinations of Heyford Park residents travelling away from the site. The data was disaggregated by mode. **Appendix B** contains details of the Census data. The modal split of journeys to/from work is shown in Table 3.3.

Table 3.3: Modal split of work trips to/from Heyford Park (source: 2001 Census)

| Mode | Trips to Heyford Park | Trips from Heyford Park | Total | Percent |
|---------------|-----------------------|-------------------------|-------------|-------------|
| Car driver | 779 | 536 | 1315 | 81% |
| Car passenger | 67 | 44 | 111 | 7% |
| Taxi | 0 | 6 | 6 | 0% |
| Train | 0 | 15 | 15 | 1% |
| Bus | 21 | 42 | 63 | 4% |
| Motorcycle | 15 | 3 | 18 | 1% |
| Bicycle | 12 | 15 | 27 | 2% |
| Foot | 29 | 38 | 67 | 4% |
| Total | 923 | 699 | 1622 | 100% |

A large majority (88%) of all journeys to and from work at Heyford Park are made by car. Foot and cycle journeys amount to some 6% and the majority of these are internal trips within the Heyford Park settlement area. Approximately 4% of trips are by bus, nearly all to/from Bicester or Oxford. Trips by train totalled 1%, all of which were from Heyford Park to either Oxford or London.

3.3 Existing traffic

Existing traffic on the local road network in the vicinity of the site is shown in **Figure 5** and **Figure 6**.

Existing trips to and from the site as a whole were calculated using the results of the Camp Road surveys. The areas of existing commercial use and existing dwellings are served by separate accesses with no connectivity which allowed existing traffic generated by the site to be disaggregated. Table 3.4 shows traffic volumes currently generated in the AM and PM peak hours which are contributing to the existing base traffic on the network.

Table 3.4: Existing AM and PM peak hour trips to/from Heyford Park

| | Dwellings | Commercial | Total |
|--------------------------|------------|------------|------------|
| AM peak | | | |
| From east | 50 | 200 | 250 |
| From west | 27 | 127 | 154 |
| <i>Total into site</i> | <i>77</i> | <i>327</i> | <i>404</i> |
| To east | 81 | 25 | 106 |
| To west | 57 | 26 | 83 |
| <i>Total out of site</i> | <i>138</i> | <i>51</i> | <i>189</i> |
| AM peak total | 215 | 378 | 593 |
| PM peak | | | |
| From east | 98 | 38 | 136 |
| From west | 60 | 24 | 84 |
| <i>Total into site</i> | <i>158</i> | <i>62</i> | <i>220</i> |
| To east | 50 | 214 | 264 |
| To west | 27 | 149 | 176 |
| <i>Total out of site</i> | <i>77</i> | <i>363</i> | <i>440</i> |
| PM Total | 235 | 425 | 660 |

4 Planning & Policy Framework

4.1 Policy Framework

The full planning policy background against which the proposed development is to be assessed is considered within the Environmental Statement. The relevant chapter identifies the relationship between the proposed development and the relevant policy statements contained within National Planning Policy Guidance and Statements, Regional Planning Guidance for the South East, the Oxfordshire Structure Plan and the Cherwell Local Plan. Consideration is also given to emerging spatial strategies and local development documents such as the RAF Upper Heyford Revised Comprehensive Planning Brief.

Areas of the planning and policy framework specific to transport issues are reviewed in this chapter.

4.2 National Planning Policy Guidance - PPG13 Transport

The key objectives of PPG13 are to integrate planning and transportation at the national, regional and local level in order to:

- Promote more sustainable transport choices;
- Promote accessibility to jobs, shopping, leisure facilities and services by public transport, walking and cycling and;
- Reduce the need to travel, especially by car.

The principles of PPG13 are, in general, incorporated into the planning application. Jobs and housing are provided together on the same site, provision will be made to support public transport, walking and cycling facilities will be provided and a travel plan introduced, facilitated by a Travel Plan Coordinator.

Prospective residents of the development, and indeed those in the neighbouring residential areas, will have access to the proposed employment, shops, community facilities, the extensive countryside area and public transport services. The scale of development and the proposed mix of uses on the site itself offer opportunities for a more self-sustaining community.

4.3 Regional Transport Strategy

The transport policies for the region are set out in the Regional Transport Strategy (RTS), which was originally part of Regional Planning Guidance for the South East (RPG 9) but was revised and issued separately in July 2004. The RTS seeks to promote development for housing, employment and other uses that reduce the need to travel by private transport, while supporting growth in the existing transportation networks and encouraging safe movement by foot, cycle and public transport in a manner which supports regeneration and the economic use of land.

The Heyford Park proposals provide educational, local retail and recreational facilities within the residential portion of a mixed-use development, incorporated well into surrounding transport network while being a self contained mixed-use scheme. The design of the settlement road layout encourages the use of forms of transport other than the private car as well as making the streets more pedestrian friendly.

Paragraph 9.19 of the RTS recognises that 20% of the population of the South East live in rural areas and that in these areas above average levels of car ownership exist and the private vehicles will continue to be the primary focus of human mobility. However, it is important to provide a 'proportionate amount of public transport' and continue to improve travel choice.

Policy T3 specifically relates to the 'rural dimension', it requires Local Transport Plans which cover areas 'not wholly urban' to:

- Take a co-ordinated approach to encouraging community based transport;
- look at methods to improve rural traffic management and look for ways to improve non-car based modes of transport between smaller settlements; and,
- develop innovative and adaptable approaches to public transport that reflect the particular social and economic needs of the region.

4.4 Structure/Local Plan & Development Framework

4.4.1 Oxfordshire County Structure Plan

The Oxfordshire Structure Plan 2016 was adopted in October 2005. Under the provisions of the Planning and Compulsory Purchase Act 2004, the Structure Plan's policies are saved for a period of three years from the date of adoption (October 2008), or until the new South East Plan is adopted, whichever is the sooner.

Of high relevance to the proposed development is a site specific policy for Upper Heyford, Policy H2. Structure Plan policy H2, clause (c) states:

'The new settlement should be designed to encourage walking, cycling and use of public transport rather than travel by private car. Improvements to bus and rail facilities and measures to minimise the impact of the traffic generated by the development on the surrounding road network will be required.'

The proposed Heyford Park development complies with the requirements; the proposed travel plan includes measures to encourage walking, cycling and use of public transport. Bus services will be supported for a fixed period and these enhancements are likely to include services to Bicester North Station. Traffic calming will be considered for local villages.

Structure Plan policies T1-6 and T8 which deal with achieving sustainable travel and a good transport network are also relevant.

4.4.2 Cherwell Local Plan 1996 and Non-Statutory Cherwell Local Plan 2011

The non-site specific policies of the Cherwell Local Plan, adopted in 1996 have also been saved under the transitional arrangements of the Planning & Compulsory Purchase Act 2004. The Plan does not contain any site specific policies for the site, although more general policies which are relevant to transport matters when considering the proposed development include:

- Policies TR1-5, TR7, TR9-10 - providing for a satisfactory transportation network;

The 1996 Cherwell Local Plan was in the process of being superseded by the Cherwell Local Plan 2011 until the Council decided to discontinue work on the new Plan in December 2004. As the new Plan had reached the pre-inquiry stage, the Council approved the Cherwell Local Plan 2011 as an interim planning policy for development control purposes.

This contains the following transport policies relevant to the proposed development:

- Policies TR1-6, TR8-11, TR16, TR19, TR36 - providing for a satisfactory transportation network.

4.5 Local Transport Plan

The Oxfordshire Local Transport Plan (LTP) covers a five-year period from April 2006 - March 2011. It focuses on five priority areas:

- tackling congestion;
- delivering accessibility;
- safer roads;
- better air quality; and,
- improving the street environment.

The plan acknowledges that Oxfordshire is a mostly rural county, in many parts of which the car is (and will continue to be) the predominant mode of travel.

It goes on to state that the design of developments can play an important part in determining the amount and type of travel generated by them. Large new residential developments in particular offer the opportunity to encourage more sustainable travel and help meet a range of policy objectives.

The County Council places a high priority on ensuring that all developments:

- Are located in accordance with Development Plan policies;
- Have the minimal adverse impact on the transport network, including addressing any problems that they might create through the provision of (or contributions towards) infrastructure and services and the adoption of Travel Plans; and
- Are designed in accordance with the County Council's Residential Design Guide (which has been developed in consultation with the District Councils), national guidelines and guidance on parking provided in PPG3 and PPG13.

Two issues are highlighted in the Local Transport Plan of particular relevance to Heyford Park; lorry routing and road safety. The Oxfordshire Freight Quality Partnership lorry route map identifies the development as a key lorry origin and specifies the route from the site to Junction 10 of the M40. Lorry routing is considered in Chapter 6.

The section of B430 from Ardley to the M40 is listed as a medium priority requiring a road safety solution with monitoring/further investigation identified as an action. Accidents are considered in Chapter 13.

5 Proposed Development

5.1 Development content

5.1.1 Assessed Land Uses

The Transport Assessment has been carried out based on the following elements:

- Residential - 1,075 dwellings
- B1 Office – 15,658sqm
- B2 Office - 17,996sqm
- B8 Storage – 86,113sqm
- Heritage Centre - 4195sqm
- Conference Centre – 4150sqm

5.1.2 Non-Trip Generating Land Uses

There are a number of other proposed land uses that will provide facilities for the new settlement:

- Retail - 743sqm
- Church – 680sqm
- Community Centre – 580sqm
- Bar/restaurant – 340sqm
- Nursery – 224sqm
- Primary School - TBA

No trips have been included in the Transport Assessment for these uses as it is assumed that any associated trips will either be internal to the site or pass-by trips.

5.2 Access arrangements

All access into the development will be gained from Camp Road via a series of existing and new access roads. The development masterplan envisages that existing roundabout junctions in the middle of the settlement that provide access from Camp Road into the development will be replaced with raised tables comprising shared use road surface without road markings or signs specifying priority. These arrangements are consistent with the Manual for Streets.

The site is currently occupied by a number of businesses that are served by Heavy Goods Vehicles, the majority of which approach the site along Camp Road having come from the M40 to the east. The existing main entry gate for HGVs lies to the far west of the settlement area and therefore a new access for HGVs and other commercial vehicles has been identified in order to remove the need for heavy traffic to pass through the settlement.

Full details of the proposed access arrangements are provided in Chapter 12.

5.3 Parking

5.3.1 Commercial

Within the commercial development, parking allocation will be in line with Oxfordshire County Council guidance:

- B1: 1 space per 30 sqm
- B2: 1 space per 50 sqm

- B8: 1 space per 200 sqm

5.3.2 Residential

An average of 1.5 off-street car parking spaces per dwelling and 0.5 on-street car parking spaces per dwelling will be provided across the residential development as a whole.

6 Traffic Impact

6.1 Design years

An opening year of 2013 has been agreed with Oxfordshire County Council and the Highways Agency. The Highways Agency requested a further test of M40 Junction 10 at 15 years after opening year (2028).

6.2 Traffic flows

Traffic flow diagrams are included in the Figures section for three scenarios:

- **Figure 7:** 2006 base AM
- **Figure 8:** 2006 base PM
- **Figure 9:** 2013 base AM
- **Figure 10:** 2013 base PM
- **Figure 11:** 2013 base plus full development AM
- **Figure 12:** 2013 base plus full development PM

Separate diagrams for each scenario are provided for Junction 10 of the M40 (**Figures 13 to 18**).

All traffic flows are for an average weekday in PCUs.

There is an imbalance between traffic flows on the local highway network and the Junction 10 network. This is likely to be because the traffic count data for the local network was obtained from different sources to that for Junction 10. The local network is based on traffic surveys commissioned and carried out during 2006 whereas the Highways Agency supplied 2004 balanced TRANSYT data for Junction 10. Nonetheless, each network is considered to be robust.

6.2.1 2006 Base

The 2006 base is derived from the 2006 survey data but with the traffic generated by the existing Heyford Park development removed.

The Junction 10 survey data was collected in 2004 and factored to produce the 2006 base from which the existing Heyford Park development traffic was removed as above.

6.2.2 2013 Base

The 2013 base represents the 2006 base with background traffic growth applied up to the opening year of 2013. Background traffic growth from base year to opening year has been calculated using NRTF Central Case adjusted by TEMPRO local forecasts for Cherwell Rural and Bicester. This produces a growth factor of 12.7% (AM) and 12.8% (PM) over the period.

6.2.3 2013 Full Development

The 2013 full development scenario represents the 2013 base plus full Heyford Park development content.

6.3 Committed Development

Details of committed development sites were obtained from the Local Planning Authority; Cherwell District Council. These are few in number and of small scale and it was subsequently agreed with Oxfordshire County Council that no account needs to be taken of traffic associated with committed development.

6.4 Distribution

The distribution of new traffic generated by the development was based on Journey to Work data from the 2001 Census for Heyford Park and Upper Heyford village. The Census data is provided in **Appendix B** and details of the methodology used for applying distribution of new trips are contained in a Technical Note provided in **Appendix C**.

6.5 Scope of Junction Assessments

Following discussion of existing traffic on the local network and the likely impact of the traffic related to the new development, it was agreed with Oxfordshire County Council that six junctions would be tested for 2006 base operation with no development, 2013 base year operation with no development and the opening year, 2013, operation with full development.

The agreed junctions for testing are:

- The staggered crossroads junction of Port Way with the B4030 Lower Heyford Road;
- The 'T' junction of the minor road from Upper Heyford with the B430 between Middleton Stoney and Ardley;
- The Chilgrove Drive junction with Camp Road immediately east of Upper Heyford airfield;
- The minor junction of Camp Road with Kirtlington Road (leading to Port Way);
- The 'T' junction of Camp Road with the Lower Heyford to Somerton Road in Upper Heyford village; and
- The signalised crossroads junction of the B4030 with the B430 at Middleton Stoney.

Traffic flow data was also reviewed for three junctions on the A4260 and it was agreed that the current levels of traffic and/or the impact of the new development were sufficiently low that further investigation of these junctions was not required:

- The A4260 crossroads junction between Duns Tew and North Aston;
- The A4260 signalised crossroads with B4030 at Hopcrofts Holt; and
- The A4260 staggered crossroads with A4095 at Bunkers Hill.

It was agreed following discussions with the Highways Agency that junction testing would be carried out for:

- M40 Junction 10 (southern roundabout only)

Figure 23 shows the assessed junctions.

6.6 HGV Routing Agreement

The proposed commercial operations at the site are likely to generate a number of daily HGV trips and therefore North Oxfordshire Consortium will enter into negotiation with Oxfordshire County Council with a view to concluding a HGV routing agreement.

7 2006 Base Traffic

The 2006 base represents traffic flows on the network with all traffic generated by the existing Heyford Park development removed. The Figures section contains traffic flow diagrams for the 2006 base AM (**Figure 7**) and the 2006 base PM (**Figure 8**).

7.1 B4030 Lower Heyford Road – Port Way

The operation of the B4030 Lower Heyford Road – Port Way priority junction has been tested using PICADY 5 for the 2006 base weekday traffic flows. A summary of the analysis results is shown in Table 7.1 and a more detailed analysis is given in **Appendix D**.

Table 7.1 B4030 Lower Heyford Road – Port Way Priority Junction – PICADY results for 2006 Base Flows

| Junction Arm Turning Movement | 2006 Base AM Peak | | 2006 Base PM Peak | |
|--|-------------------|-----------|-------------------|-----------|
| | Max. RFC | Max Queue | Max RFC | Max Queue |
| Port Way (S) Ahead + Left | 0.057 | 0 | 0.296 | 0 |
| Port Way (S) (Ahead + Right) | 0.096 | 0 | 0.262 | 0 |
| B4030 Lower Heyford Road (E) (All Movements) | 0.000 | 0 | 0.002 | 0 |
| Port Way (N) (Ahead + Left) | 0.020 | 0 | 0.006 | 0 |
| Port Way (N) (Ahead + Right) | 0.026 | 0 | 0.008 | 0 |
| B4030 Lower Heyford Road (W) (All Movements) | 0.086 | 0 | 0.014 | 0 |

In the 2006 base AM peak, the junction has a maximum RFC of 0.096 for the ahead and right movements from Port Way (S), with no queuing predicted. In the 2006 base PM peak, the junction has a maximum RFC of 0.296 for the ahead and left turn movements from Port Way (S), with no queuing predicted.

In summary, it can be seen from Table 7.1 that the junction operates well within its theoretical capacity threshold (RFC of 0.85) during the 2006 base AM and PM peak hours.

7.2 B430 Ardley Road – Unnamed Road towards Camp Road

The operation of the B430 Ardley Road/Unnamed Road towards Camp Road priority junction has been tested using PICADY 5 for the 2006 weekday base flows. A summary of the analysis results is shown in Table 7.2 and detailed analysis is given in **Appendix D**.

Table 7.2 B430 Ardley Road – Unnamed Road towards Camp Road – PICADY results for 2006 Base Flows

| Junction Arm Turning Movement | 2006 Base AM Peak | | 2006 Base PM Peak | |
|---|-------------------|-----------|-------------------|-----------|
| | Max. RFC | Max Queue | Max RFC | Max Queue |
| Unnamed Road (Left) | 0.049 | 0 | 0.075 | 0 |
| Unnamed Road (Right) | 0.000 | 0 | 0.003 | 0 |
| B430 Ardley Road (N) (All Movements) | 0.125 | 0 | 0.037 | 0 |

In the weekday AM peak the junction has a maximum RFC of 0.125 on the B430 Ardley Road (N) approach for all movements, with no queuing predicted. In the weekday PM peak the junction has a maximum RFC of 0.075 on the Unnamed Road approach for the left turn, with no queuing predicted.

In summary, it can be seen from Table 7.2 that the junction operates well within its theoretical capacity threshold (RFC of 0.85) during the 2006 base AM and PM peak hours.

7.3 Camp Road – Unnamed Road towards B430

The operation of the Camp Road/Unnamed Road towards the B430 priority junction has been tested using PICADY 5 for the 2006 weekday base flows. A summary of the analysis results is shown in Table 7.3 and a more detailed analysis is given in **Appendix D**.

Table 7.3: Camp Road - Unnamed Road towards B430 – PICADY results for 2006 Base Flows

| Junction Arm Turning Movement | 2006 Base AM Peak | | 2006 Base PM Peak | |
|--|-------------------|-----------|-------------------|-----------|
| | Max. RFC | Max Queue | Max RFC | Max Queue |
| Unnamed Road from B430 (Left) | 0.027 | 0 | 0.005 | 0 |
| Unnamed Road from B430 (Right) | 0.049 | 0 | 0.026 | 0 |
| Unnamed Road from Middleton Stoney (S) (All Movements) | 0.014 | 0 | 0.029 | 0 |

In the weekday AM peak the junction has a maximum RFC of 0.049 on the Unnamed Road approach for the right turn, with no queuing predicted.

In the weekday PM peak the junction has a maximum RFC of 0.029 on the Unnamed Road from Middleton Stoney approach for all movements, with no queuing predicted.

In summary, it can be seen from Table 7.3 that the junction operates well within its theoretical capacity threshold (RFC of 0.85) during the 2006 base AM and PM peak hours.

7.4 Camp Road – Kirtlington Road

The operation of the Camp Road/Kirtlington Road priority junction has been tested using PICADY 5 for the 2006 weekday base flows. A summary of the analysis results is shown in Table 7.4 and a more detailed analysis is given in **Appendix D**.

Table 7.4: Camp Road – Kirtlington Road – PICADY results for 2006 Base Flows

| Junction Arm Turning Movement | 2006 Base AM Peak | | 2006 Base PM Peak | |
|-------------------------------------|-------------------|-----------|-------------------|-----------|
| | Max. RFC | Max Queue | Max RFC | Max Queue |
| Kirtlington Road (All Movements) | 0.006 | 0 | 0.116 | 0 |
| Camp Road (W) (All Movements) | 0.027 | 0 | 0.009 | 0 |

In the weekday AM peak the junction has a maximum RFC of 0.027 on the Camp Road (W) approach for all movements, with no queuing predicted. In the weekday PM peak the junction has a maximum RFC of 0.116 on Kirtlington Road approach for all movements, with no queuing predicted.

In summary, it can be seen from Table 7.4 that the junction operates well within its theoretical capacity threshold (RFC of 0.85) during the 2006 base AM and PM peak hours.

7.5 Camp Road - Somerton Road

The operation of the Camp Road/Somerton Road priority junction has been tested using PICADY 5 for the 2006 weekday base flows. A summary of the analysis results is shown in Table 7.5 and a more detailed analysis is given in **Appendix D**.

Table 7.5: Camp Road – Somerton Road – PICADY results for 2006 Base Flows

| Junction Arm Turning Movement | 2006 Base AM Peak | | 2006 Base PM Peak | |
|---|-------------------|-----------|-------------------|-----------|
| | Max. RFC | Max Queue | Max RFC | Max Queue |
| Camp Road (Left) | 0.067 | 0 | 0.038 | 0 |
| Camp Road (Right) | 0.028 | 0 | 0.096 | 0 |
| Lower Heyford Road (S) (All Movements) | 0.024 | 0 | 0.011 | 0 |

In the weekday AM peak the junction has a maximum RFC of 0.067 on the Camp Road approach for the left turn, with no queuing predicted. In the weekday PM peak the junction has a maximum RFC of 0.096 on the Camp Road approach for the right turn, with no queuing predicted.

In summary, it can be seen from Table 7.5 that the junction operates well within its theoretical capacity threshold (RFC of 0.85) during the 2006 base AM and PM peak hours.

7.6 B4030 with the B430 at Middleton Stoney

The operation of the B4030 signalised junction with the B430 at Middleton Stoney has been tested using LINSIG for the 2006 weekday base flows. A summary of the analysis results is shown in Table 7.6 and a more detailed analysis is given in **Appendix I**.

Table 7.6: B4030 with the B430 junction at Middleton Stoney – LINSIG results for 2006 Base Flows

| Junction Arm Movement | 2006 Base AM Peak | | 2006 Base PM Peak | |
|---|--------------------------|----------------------|--------------------------|----------------------|
| | Degree of Saturation (%) | Mean Max Queue (PCU) | Degree of Saturation (%) | Mean Max Queue (PCU) |
| B4030 East (W/B) Left Ahead Right | 77.6 | 9 | 77.5 | 8 |
| B430 Ardley Road South (N/B) Right Left Ahead | 69.1 | 7 | 81.1 | 14 |
| B4030 West (E/B) Ahead Right Left | 77.1 | 10 | 82.0 | 10 |
| B430 Ardley Road North (S/B) Left Ahead Right | 80.6 | 16 | 61.2 | 9 |

In the weekday AM peak the junction has a maximum Degree of Saturation of 80.6% on the B430 Ardley Road southbound approach for all movements. In the weekday PM peak the junction has a maximum Degree of Saturation of 82% on the B4030 eastbound approach for all movements.

In summary, it can be seen from Table 7.6 that the junction operates within its theoretical capacity threshold (90% DoS) during the 2006 base AM and PM peak hours.

7.7 Summary of 2006 Base Year Junction Performance

The 2006 base represents traffic flows on the network with all traffic generated by the existing Heyford Park development removed. Under this scenario, all of the six tested junctions operate within their theoretical capacity thresholds.

8 2013 Base Year Traffic

The 2013 base represents the 2006 base with background traffic growth applied up to the opening year of 2013. Background traffic growth from base year to opening year has been calculated using NRTF Central Case adjusted by TEMPRO local forecasts for Cherwell Rural and Bicester. This produces a growth factor of 12.7% (AM) and 12.8% (PM) over the period. The traffic growth calculations are contained in **Appendix H**. The Figures section contains traffic flow diagrams for the 2013 base AM (**Figure 9**) and the 2013 base PM (**Figure 10**).

8.1 B4030 Lower Heyford Road – Port Way

The operation of the B4030 Lower Heyford Road/Port Way priority junction has been tested using PICADY 5 for the 2013 weekday base flows. A summary of the analysis results is shown in Table 8.1 and detailed analysis is given in **Appendix D**.

Table 8.1: B4030 Lower Heyford Road – Port Way Priority Junction – PICADY results for 2013 Base Flows

| Junction Arm Turning Movement | 2013 Base AM Peak | | 2013 Base PM Peak | |
|--|-------------------|-----------|-------------------|-----------|
| | Max RFC | Max Queue | Max RFC | Max Queue |
| Port Way (S) Ahead + Left | 0.065 | 0 | 0.345 | 1 |
| Port Way (S) (Ahead + Right) | 0.110 | 0 | 0.301 | 0 |
| B4030 Lower Heyford Road (E) (All Movements) | 0.000 | 0 | 0.002 | 0 |
| Port Way (N) (Ahead + Left) | 0.023 | 0 | 0.007 | 0 |
| Port Way (N) (Ahead + Right) | 0.029 | 0 | 0.012 | 0 |
| B4030 Lower Heyford Road (W) (All Movements) | 0.098 | 0 | 0.018 | 0 |

From Table 8.1 it can be seen that in the 2013 base AM peak the junction has a maximum RFC of 0.110 for the ahead and right movements from Port Way (S), with no queuing predicted. In the 2013 base PM peak the junction has a maximum RFC of 0.345 for the ahead and left turn movements from Port Way (S), with a queue of 1 predicted.

In summary, it can be seen from Table 8.1 that the junction operates well within its theoretical capacity threshold (RFC of 0.85) in the 2013 base during the AM and PM peak hours.

8.2 B430 Ardley Road – Unnamed Road towards Camp Road

The operation of the B430 Ardley Road/Unnamed Road towards Camp Road priority junction has been tested using PICADY 5 for the weekday 2013 base flows. A summary of the analysis results is shown in Table 8.2 and detailed analysis is given in **Appendix D**.

Table 8.2: B430 Ardley Road – Unnamed Road towards Camp Road – PICADY results for 2013 Base Flows

| Junction Arm Turning Movement | 2013 Base AM Peak | | 2013 Base PM Peak | |
|---|-------------------|-----------|-------------------|-----------|
| | Max. RFC | Max Queue | Max RFC | Max Queue |
| Unnamed Road (Left) | 0.055 | 0 | 0.085 | 0 |
| Unnamed Road (Right) | 0.000 | 0 | 0.003 | 0 |
| B430 Ardley Road (N) (All Movements) | 0.144 | 0 | 0.043 | 0 |

In the weekday 2013 base AM peak the junction has a maximum RFC of 0.144 on the B430 Ardley Road (N) approach for all movements, with no queuing predicted. In the weekday 2013 base PM peak the junction has a maximum RFC of 0.085 on the Unnamed Road approach for the left turn, with no queuing predicted.

In summary, the junction operates well within its theoretical capacity threshold (RFC of 0.85) in the 2013 base scenario during the AM and PM peak hours.

8.3 Camp Road – Unnamed Road towards B430

The operation of the Camp Road/Unnamed Road towards the B430 priority junction has been tested, using PICADY 5, for the 2013 weekday base flows. A summary of the analysis results is shown in Table 8.3 and detailed analysis is given in **Appendix D**.

Table 8.3: Camp Road - Unnamed Road towards B430 – PICADY results for 2013 Base Flows

| Junction Arm Turning Movement | 2013 Base AM Peak | | 2013 Base PM Peak | |
|--|-------------------|-----------|-------------------|-----------|
| | Max. RFC | Max Queue | Max RFC | Max Queue |
| Unnamed Road from B430 (Left) | 0.031 | 0 | 0.006 | 0 |
| Unnamed Road from B430 (Right) | 0.056 | 0 | 0.029 | 0 |
| Unnamed Road from Middleton Stoney (S) (All Movements) | 0.016 | 0 | 0.035 | 0 |

In the weekday 2013 base AM peak the junction has a maximum RFC of 0.056 on the Unnamed Road approach for the right turn, with no queuing predicted. In the weekday 2013

base PM peak the junction has a maximum RFC of 0.035 on the Unnamed Road from Middleton Stoney approach for all movements, with no queuing predicted.

In summary, the junction operates well within its theoretical capacity threshold (RFC of 0.85) in the 2013 base scenario during the AM and PM peak hours.

8.4 Camp Road – Kirtlington Road

The operation of the Camp Road/Kirtlington Road priority junction has been tested using PICADY 5 for the 2013 weekday base flows. A summary of the analysis results is shown in Table 8.4 and detailed analysis is given in **Appendix D**.

Table 8.4: Camp Road – Kirtlington Road – PICADY results for 2013 Base Flows

| Junction Arm Turning Movement | 2013 Base AM Peak | | 2013 Base PM Peak | |
|-------------------------------------|-------------------|-----------|-------------------|-----------|
| | Max. RFC | Max Queue | Max RFC | Max Queue |
| Kirtlington Road (All Movements) | 0.009 | 0 | 0.131 | 0 |
| Camp Road (W) (All Movements) | 0.031 | 0 | 0.009 | 0 |

In the weekday 2013 base AM peak the junction has a maximum RFC of 0.031 on the Camp Road (W) approach for all movements, with no queuing predicted. In the weekday 2013 base PM peak the junction has a maximum RFC of 0.130 on Kirtlington Road approach for all movements, with no queuing predicted.

In summary, the junction operates well within its theoretical capacity threshold (RFC of 0.85) in the 2013 base scenario during the AM and PM peak hours.

8.5 Camp Road - Somerton Road

The operation of the Camp Road/Somerton Road priority junction has been tested using PICADY 5 for the 2013 weekday base flows. A summary of the analysis results is shown in Table 8.5 and detailed analysis is given in **Appendix D**.

Table 8.5: Camp Road – Somerton Road – PICADY results for 2013 Base Flows

| Junction Arm Turning Movement | 2013 Base AM Peak | | 2013 Base PM Peak | |
|---|-------------------|-----------|-------------------|-----------|
| | Max. RFC | Max Queue | Max RFC | Max Queue |
| Camp Road (Left) | 0.076 | 0 | 0.043 | 0 |
| Camp Road (Right) | 0.030 | 0 | 0.110 | 0 |
| Lower Heyford Road (S) (All Movements) | 0.026 | 0 | 0.013 | 0 |

In the weekday 2013 base AM peak the junction has a maximum RFC of 0.076 on the Camp Road approach for the left turn, with no queuing predicted. In the weekday 2013 base PM peak the junction has a maximum RFC of 0.110 on the Camp Road approach for the right turn, with no queuing predicted.

In summary, the junction operates well within its theoretical capacity threshold (RFC of 0.85) in the 2013 base scenario during the AM and PM peak hours.

8.6 B4030 with the B430 at Middleton Stoney

The operation of the B4030 signalised junction with the B430 at Middleton Stoney has been tested with existing staging using LINSIG for the 2013 weekday base flows. A summary of the analysis results is shown in Table 8.6 and detailed analysis is given in **Appendix I**.

Table 8.6: B4030 with the B430 junction at Middleton Stoney – LINSIG results for 2013 Base Flows

| Junction Arm Movement | 2013 Base AM Peak | | 2013 Base PM Peak | |
|---|--------------------------|----------------------|--------------------------|----------------------|
| | Degree of Saturation (%) | Mean Max Queue (PCU) | Degree of Saturation (%) | Mean Max Queue (PCU) |
| B4030 East (W/B) Left Ahead Right | 91.5 | 13 | 93.0 | 12 |
| B430 Ardley Road South (N/B) Right Left Ahead | 85.6 | 10 | 95.1 | 21 |
| B4030 West (E/B) Ahead Right Left | 91.2 | 13 | 92.4 | 13 |
| B430 Ardley Road North (S/B) Left Ahead Right | 95.9 | 25 | 92.3 | 15 |

In the weekday AM peak the junction has a maximum Degree of Saturation of 95.9% on the B430 Ardley Road southbound approach for all movements with a mean maximum queue of 25 predicted. In the weekday PM peak the junction has a maximum Degree of Saturation of 95.1% with a mean maximum queue of 21 predicted on the B430 Ardley Road northbound approach for all movements.

In summary, it can be seen from Table 7.6 that, with existing staging, the junction no longer operates within its theoretical capacity threshold (90% DoS) during the 2013 base AM and PM peak hours.

8.7 Summary of 2013 Base Year Junction Performance

The 2013 base represents the 2006 base with background traffic growth applied up to the opening year of 2013. Within this scenario all the tested junctions operate within their theoretical capacity with the exception of the B4030 signalised junction with the B430 at Middleton Stoney. This junction operates within capacity in the 2006 base but the application of traffic growth over the period up to 2013 causes the junction to exceed its capacity in the 2013 AM and PM base scenarios.

9 Trip generation

9.1 Residential

Trip generation rates for the residential units were agreed with Oxfordshire County Council and are shown in Table 9.1 along with the number of trips generated.

Table 9.1 Trip Rates for New Residential Development

| Peak Hour | Trip Generation Rates (per dwelling) | | | Number of Trips | | |
|-----------|--------------------------------------|------------|-------|-----------------|------------|-------|
| | Arrivals | Departures | Total | Arrivals | Departures | Total |
| AM | 0.17 | 0.63 | 0.80 | 183 | 677 | 860 |
| PM | 0.51 | 0.29 | 0.80 | 548 | 312 | 860 |

From Table 9.1 it can be seen that the 1075 dwellings will generate 860 trips in both the AM and PM peak hours.

9.2 Employment

The following areas of commercial development are proposed for the site:

- B1 Office - 15,658sqm
- B2 Office - 17,996sqm
- B8 Storage – 86,113sqm

Trip generation rates for commercial land uses were developed from TRICS and subsequently amended and agreed with Oxfordshire County Council. These are shown in Tables 9.2 to 9.4 along with the numbers of trips generated.

Table 9.2: Trip Rates for B1 Employment Development

| Peak Hour | Trip Generation Rates (per 100sqm) | | | Number of Trips | | |
|-----------|------------------------------------|------------|-------|-----------------|------------|-------|
| | Arrivals | Departures | Total | Arrivals | Departures | Total |
| AM | 1.81 | 0.28 | 2.09 | 283 | 44 | 327 |
| PM | 0.42 | 1.62 | 2.04 | 66 | 254 | 320 |

From Table 9.2 it can be seen that the 15,658sqm of B1 employment land use will generate 327 trips in the AM and 320 trips in the PM peak hours.

Table 9.3: Trip Rates for B2 Employment Development

| Peak Hour | Trip Generation Rates (per 100sqm) | | | Number of Trips | | |
|-----------|------------------------------------|------------|-------|-----------------|------------|-------|
| | Arrivals | Departures | Total | Arrivals | Departures | Total |
| AM | 1.09 | 0.35 | 1.44 | 196 | 63 | 259 |
| PM | 0.21 | 0.83 | 1.04 | 38 | 149 | 187 |

From Table 9.3 it can be seen that the 17,996sqm of B2 employment land use will generate 259 trips in the AM and 187 trips in the PM peak hours.

Table 9.4: Trip Rates for B8 Employment Development

| Peak Hour | Trip Generation Rates (per 100sqm) | | | Number of Trips | | |
|-----------|------------------------------------|------------|-------|-----------------|------------|-------|
| | Arrivals | Departures | Total | Arrivals | Departures | Total |
| AM | 0.23 | 0.11 | 0.34 | 198 | 95 | 293 |
| PM | 0.13 | 0.23 | 0.36 | 112 | 198 | 310 |

From Table 9.4 it can be seen that the 86,113sqm of B8 employment land use will generate 293 trips in the AM and 310 trips in the PM peak hours.

9.2.1 Heritage Centre and Conference Centre

A Heritage Centre and Conference Centre are proposed with the following areas:

- Heritage Centre - 4195sqm
- Conference Centre - 4150sqm

Trip rates derived using the TRICS database are shown in Tables 9.5 and 9.6.

Table 9.5: Trip Rates for Heritage Centre

| Peak Hour | Trip Generation Rates (per 100sqm) | | | Number of Trips | | |
|-----------|------------------------------------|------------|-------|-----------------|------------|-------|
| | Arrivals | Departures | Total | Arrivals | Departures | Total |
| AM | 0.08 | 0.00 | 0.08 | 3 | 0 | 3 |
| PM | 0.02 | 0.23 | 0.25 | 1 | 10 | 11 |

From Table 9.5 it can be seen that the Heritage Centre will generate 3 trips in the AM and 11 trips in the PM peak hours.

Table 9.6: Trip Rates for Conference Centre

| Peak Hour | Trip Generation Rates (per 100sqm) | | | Number of Trips | | |
|-----------|------------------------------------|------------|-------|-----------------|------------|-------|
| | Arrivals | Departures | Total | Arrivals | Departures | Total |
| AM | 0.34 | 0.17 | 0.51 | 14 | 7 | 21 |
| PM | 0.35 | 0.30 | 0.65 | 15 | 13 | 28 |

From Table 9.6 it can be seen that the Conference Centre will generate 21 trips in the AM and 28 trips in the PM peak hours.

9.3 Trip Rates from Existing Land Uses

Existing trips from Heyford Park are quantified in Section 3.3. Table 9.7 and 9.8 show trip generation rates derived from these figures.

9.3.1 Residential

Table 9.7: Trip Rates for Existing Residential Development

| Peak Hour | Trip Generation Rates (per dwelling) | | | Number of Trips | | |
|-----------|--------------------------------------|------------|-------|-----------------|------------|-------|
| | Arrivals | Departures | Total | Arrivals | Departures | Total |
| AM | 0.24 | 0.44 | 0.68 | 77 | 138 | 215 |
| PM | 0.50 | 0.24 | 0.75 | 158 | 77 | 235 |

It can be seen from Table 9.7 that the 315 occupied dwellings on the site generate 215 trips in the AM and 235 in the PM peak hours which equates to trip rates of 0.68 in the AM and 0.75 in the PM, slightly lower than the trip rates of 0.80 AM and 0.80 PM used for the new residential development and therefore substantiate the agreed rates.

9.3.2 Commercial

Table 9.8: Average Trip Rates for Existing Employment Development

| Peak Hour | Trip Generation Rates (per 100sqm) | | | Number of Trips | | |
|-----------|------------------------------------|------------|-------|-----------------|------------|-------|
| | Arrivals | Departures | Total | Arrivals | Departures | Total |
| AM | 0.56 | 0.09 | 0.65 | 327 | 51 | 378 |
| PM | 0.11 | 0.62 | 0.73 | 62 | 363 | 425 |

The existing employment land uses generate 378 trips in the AM peak and 425 trips in the PM. This equates to trip rates of 0.65 in the AM and 0.73 in the PM peak hours.

The surveys of existing traffic from the site were not disaggregated into the three Class B commercial land uses, therefore the trip rates in Table 9.8 are averages based on the total area of existing Class B which is comprised of B1, B2 and B8 as shown in Table 9.9.

Table 9.9: Areas of Existing and Proposed Employment Development

| Class Use | Existing | Percentage | Proposed | Percentage |
|-----------|----------|------------|----------|------------|
| B1 | 5,030 | 9% | 15,685 | 13% |
| B2 | 11,070 | 18% | 17,996 | 15% |
| B8 | 42,633 | 73% | 86,113 | 72% |
| Total | 58,733 | | 119,794 | |

Table 9.9 also shows the areas of proposed B1, B2 and B8. It can be seen that the percentages of each are similar to the existing development. Therefore, Table 9.10 shows average trip rates for the proposed development which may be compared with Table 9.8.

Table 9.10: Average Trip Rates for Proposed Employment Development

| Peak Hour | Trip Generation Rates (per 100sqm) | | | Number of Trips | | |
|-----------|------------------------------------|------------|-------|-----------------|------------|-------|
| | Arrivals | Departures | Total | Arrivals | Departures | Total |
| AM | 0.56 | 0.17 | 0.73 | 678 | 202 | 880 |
| PM | 0.18 | 0.50 | 0.68 | 216 | 601 | 817 |

The trip rates calculated from existing employment uses on the site are similar to those used to assess future trips from the new employment and therefore substantiate the agreed rates.

10 2013 Opening Year Traffic

The 2013 full development represents the 2013 base with Heyford Park full development traffic added. The Figures section contains traffic flow diagrams for the 2013 base plus full development AM (**Figure 11**) and the 2013 base plus full development PM (**Figure 12**).

10.1 B4030 Lower Heyford Road – Port Way

The operation of the B4030 Lower Heyford Road/Port Way priority junction has been tested using PICADY 5 for the 2013 weekday base plus full development traffic flows. A summary of the analysis results is shown in Table 10.1 and detailed analysis is given in **Appendix D**.

Table 10.1: B4030 Lower Heyford Road – Port Way Priority Junction – PICADY results for 2013 Base Plus Full Development Flows

| Junction Arm Turning Movement | 2013 Base Plus Dev AM | | 2013 Base Plus Dev PM | |
|--|-----------------------|-----------|-----------------------|-----------|
| | Max RFC | Max Queue | Max RFC | Max Queue |
| Port Way (S) Ahead + Left | 0.133 | 0 | 0.492 | 1 |
| Port Way (S) (Ahead + Right) | 0.184 | 0 | 0.378 | 1 |
| B4030 Lower Heyford Road (E) (All Movements) | 0.00 | 0 | 0.002 | 0 |
| Port Way (N) (Ahead + Left) | 0.104 | 0 | 0.067 | 0 |
| Port Way (N) (Ahead + Right) | 0.122 | 0 | 0.083 | 0 |
| B4030 Lower Heyford Road (W) (All Movements) | 0.098 | 0 | 0.018 | 0 |

From Table 10.1 it can be seen that in the 2013 base plus full development AM peak the junction has a maximum RFC of 0.184 for the ahead and right movements from Port Way (S), with no queuing predicted. In the PM peak the junction has a maximum RFC of 0.492 for the ahead and left turn movements from Port Way (S), with a maximum queue of one vehicle predicted.

In summary, it can be seen from Table 10.1 that the junction operates well within its theoretical capacity threshold (RFC of 0.85) in the 2013 base plus full development scenario during the AM and PM peak hours.

10.2 B430 Ardley Road – Unnamed Road towards Camp Road junction

The operation of the B430 Ardley Road/Unnamed Road towards Camp Road priority junction has been tested using PICADY 5 for the weekday 2013 base plus full development flows. A summary of the analysis results is shown in Table 10.2 and detailed analysis is given in **Appendix D**.

Table 10.2: B430 Ardley Road – Unnamed Road – PICADY results for 2013 Base plus Full Development Flows

| Junction Arm Turning Movement | 2013 Base Plus Dev AM Peak | | 2013 Base Plus Dev PM Peak | |
|---|-------------------------------|-----------|-------------------------------|-----------|
| | Max. RFC | Max Queue | Max RFC | Max Queue |
| Unnamed Road (Left) | 0.486 | 1 | 0.699 | 2 |
| Unnamed Road (Right) | 0.000 | 0 | 0.006 | 0 |
| B430 Ardley Road (N) (All Movements) | 0.755 | 3 | 0.489 | 1 |

In the weekday 2013 base plus full development AM peak the junction has a maximum RFC of 0.755 on the B430 Ardley Road (N) approach for all movements, with a queue of 3 predicted.

In the weekday 2013 base plus full development PM peak the junction has a maximum RFC of 0.699 on the Unnamed Road approach for the left turn, with a queue of 2 predicted.

In summary, the junction operates well within its theoretical capacity threshold (RFC of 0.85) in the 2013 base plus full development scenario during the AM and PM peak hours.

10.3 Camp Road – Unnamed Road towards B430

The operation of the Camp Road/Unnamed Road towards the B430 priority junction has been tested, using PICADY 5, for the 2013 weekday base plus full development flows. A summary of the analysis results is shown in Table 10.3 and detailed analysis is given in **Appendix D**.

Table 10.3: Camp Road - Unnamed Road – PICADY results for 2013 Base Plus Full Development Flows

| Junction Arm Turning Movement | 2013 Base Plus Dev AM Peak | | 2013 Base Plus Dev PM Peak | |
|--|-------------------------------|-----------|-------------------------------|-----------|
| | Max. RFC | Max Queue | Max RFC | Max Queue |
| Unnamed Road from B430 (Left) | 0.546 | 1 | 0.012 | 0 |
| Unnamed Road from B430 (Right) | 0.926 | 8 | 0.629 | 2 |
| Unnamed Road from Middleton Stoney (S) (All Movements) | 0.021 | 0 | 0.047 | 0 |

In the weekday 2013 base plus development AM peak the junction has a maximum RFC of 0.926 on the Unnamed Road approach for the right turn, with a queue of 8 predicted.

In the weekday 2013 base plus development PM peak the junction has a maximum RFC of 0.629 on the Unnamed Road approach for the right turn, with a queue of 2 predicted.

In summary, the junction operates well within its theoretical capacity threshold (RFC of 0.85) in the 2013 base plus development scenario during the PM peak hour but operates just above capacity, with only a small maximum queue of 8 vehicles during the AM peak hour.

10.4 Camp Road – Kirtlington Road

The operation of the Camp Road/Kirtlington Road priority junction has been tested using PICADY 5 for the 2013 weekday base plus full development flows. A summary of the analysis results is shown in Table 10.4 and detailed analysis is given in **Appendix D**.

Table 10.4: Camp Road – Kirtlington Road – PICADY results for 2013 Base plus Full Development Flows

| Junction Arm Turning Movement | 2013 Base Plus Dev AM Peak | | 2013 Base Plus Dev PM Peak | |
|-------------------------------------|-------------------------------|-----------|-------------------------------|-----------|
| | Max. RFC | Max Queue | Max RFC | Max Queue |
| Kirtlington Road (All Movements) | 0.171 | 0 | 0.344 | 1 |
| Camp Road (W) (All Movements) | 0.034 | 0 | 0.010 | 0 |

In the weekday 2013 base plus full development AM peak the junction has a maximum RFC of 0.171 on the Kirtlington Road approach for all movements, with no queuing predicted. In the weekday 2013 base plus full development PM peak the junction has a maximum RFC of 0.344 on Kirtlington Road approach for all movements, with a queue of 1 predicted.

In summary, the junction operates well within its theoretical capacity threshold (RFC of 0.85) in the 2013 base plus full development scenario during the AM and PM peak hours.

10.5 Camp Road - Somerton Road

The operation of the Camp Road/Somerton Road priority junction has been tested using PICADY 5 for the 2013 weekday base plus full development flows. A summary of the analysis results is shown in Table 10.5 and detailed analysis is given in **Appendix D**.

Table 10.5: Camp Road – Somerton Road – PICADY results for 2013 Base plus Full Development Flows

| Junction Arm Turning Movement | 2013 Base Plus Dev AM Peak | | 2013 Base Plus Dev PM Peak | |
|---|-------------------------------|-----------|----------------------------|-----------|
| | Max. RFC | Max Queue | Max RFC | Max Queue |
| Camp Road (Left) | 0.175 | 0 | 0.180 | 0 |
| Camp Road (Right) | 0.332 | 0 | 0.476 | 1 |
| Lower Heyford Road (S) (All Movements) | 0.170 | 0 | 0.149 | 0 |

In the weekday 2013 base plus full development AM peak the junction has a maximum RFC of 0.332 on the Camp Road approach for the right turn, with no queuing predicted. In the weekday 2013 base plus full development PM peak the junction has a maximum RFC of 0.476 on the Camp Road approach for the right turn, with a queue of 1 predicted.

In summary, the junction operates well within its theoretical capacity threshold (RFC of 0.85) in the 2013 base plus full development scenarios during the AM and PM peak hours.

10.6 B4030 with the B430 at Middleton Stoney

The operation of the B4030 signalised junction with the B430 at Middleton Stoney has been tested, with existing staging, using LINSIG for the 2013 weekday base plus full development flows. A summary of the analysis results is shown in Table 10.6 and detailed analysis is given in **Appendix I**.

Table 10.6: B4030 with the B430 junction at Middleton Stoney – LINSIG results for 2013 Base plus Full Development Flows

| Junction Arm Movement | 2013 Base plus Full Development AM Peak | | 2006 Base plus Full Development PM Peak | |
|---|---|----------------------|---|----------------------|
| | Degree of Saturation (%) | Mean Max Queue (PCU) | Degree of Saturation (%) | Mean Max Queue (PCU) |
| B4030 East (W/B) Left Ahead Right | 133.8 | 77 | 144.8 | 90 |
| B430 Ardley Road South (N/B) Right Left Ahead | 118.2 | 50 | 109.7 | 61 |
| B4030 West (E/B) Ahead Right Left | 135.5 | 109 | 147.9 | 112 |
| B430 Ardley Road North (S/B) Left Ahead Right | 131.9 | 95 | 146.6 | 68 |

In the weekday AM peak the junction has a maximum Degree of Saturation of 135.5% on the B4030 eastbound approach for all movements with a mean maximum queue of 109 predicted. In the weekday PM peak the junction has a maximum Degree of Saturation of 147.9% with a mean maximum queue of 112 predicted on the B4030 eastbound approach for all movements.

In summary, it can be seen from Table 10.6 that, with existing junction layout and staging, the capacity problems experienced in the 2013 base scenario are worsened by the application of development traffic and that the junction is forecast to operate well in excess of its theoretical capacity threshold.

10.6.1 Mitigation Measures

Work was undertaken using LINSIG to optimise the signal stagings at the B4030 signalised junction with the B430 at Middleton Stoney which produced an improvement in junction performance but was insufficient to completely mitigate the impact of the development traffic. Further work was therefore undertaken to identify potential improvements in the geometric layout of the junction. Details of the proposed improvements to the staging are provided in **Appendix I** and the proposed changes to the junction geometry are shown in **Figure 35**.

The operation of the improved junction has been tested with proposed staging and revised geometry using LINSIG for the 2013 weekday base plus full development flows. A summary of the analysis results is shown in Table 10.7 and detailed analysis is given in **Appendix I**.

Table 10.7: B4030 with the B430 junction at Middleton Stoney – LINSIG results for 2013 Base plus Full Development Flows with Proposed Staging and Geometry Improvements

| Junction Arm Movement | 2013 Base plus Full Development AM Peak | | 2006 Base plus Full Development PM Peak | |
|---|---|----------------------|---|----------------------|
| | Degree of Saturation (%) | Mean Max Queue (PCU) | Degree of Saturation (%) | Mean Max Queue (PCU) |
| B4030 East (W/B) Left Ahead Right | 97.4 | 22 | 90.0 | 17 |
| B430 Ardley Road South (N/B) Right Left Ahead | 59.4 | 11 | 89.0 | 21 |
| B4030 West (E/B) Ahead Right Left | 99.6 | 32 | 89.8 | 21 |
| B430 Ardley Road North (S/B) Left Ahead Right | 98.7 | 30 | 56.7 | 10 |

With the mitigation measures applied, in the weekday AM peak the junction has a maximum Degree of Saturation of 99.6% on the B4030 eastbound approach for all movements with a queue of 32 predicted. In the weekday PM peak the junction has a maximum Degree of Saturation of 90.0% with a mean maximum queue of 17 predicted on the B4030 westbound approach for all movements.

The overall effect of the changes to the junction layout, taken with the optimised signal stagings, is to return the performance of the junction to a similar condition to the 2013 'do nothing' situation. In the PM peak the Degree of Saturation is reduced on all four arms of the junction from between 92.3% and 95.1% in the 2013 base, down to 56.7% to 90.0% with the mitigation in place. The queue lengths are slightly increased on the B4030 approaches, the same on the B430 northbound approach but reduced from 15 to 10 on the B430 southbound approach. This has been brought about by provision of a right-turn lane which has allowed a reservoir of some 5 right-turning PCUs to stand clear without blocking the ahead movement.

In the AM peak the changes to junction performance are similar although the Degree of Saturation has increased on three arms and only reduced on one. The queue lengths are increased on the B4030 approaches, virtually the same on the B430 northbound approach and increased slightly on the B430 southbound approach.

In summary, it can be seen from Table 10.7 that, with the implementation of the proposed staging and junction geometry improvements, the junction operates slightly above its theoretical capacity threshold (90% DoS) during the 2013 base plus full development AM peak hours and within its theoretical capacity threshold in the PM peak. Queue lengths have decreased for some movements and increased for others. In the 2013 base scenario the junction will already be operating above its theoretical capacity threshold but with the proposed mitigation measures in place, the overall impact of the development is one of nil detriment when compared with the 'do-nothing' situation.

The increases in queue lengths on the B4030 approaches reflect the assignment of additionally generated traffic between the development and Bicester. An alternative route, however is available via Ardley and Bucknell. As the Middleton Stoney crossroads approaches capacity, some of the traffic between the site and Bicester will choose to use the alternative route to reduce its journey time, thus maintaining this junction within its capacity. This possibility has been tested as a Sensitivity Test agreed with Oxfordshire County Council (see Section 10.8).

10.7 Summary of Opening Year Junction Performance

The 2013 full development represents the 2013 base with Heyford Park full development traffic added. Within this scenario four of the tested junctions; the staggered crossroads junction of Port Way with the B4030 Lower Heyford Road; the 'T' junction of the minor road from Upper Heyford with the B430 between Middleton Stoney and Ardley; the minor junction of Camp Road with Kirtlington Road; and the 'T' junction of Camp Road with the Lower Heyford to Somerton Road in Upper Heyford village; all operate within their theoretical capacity threshold in the 2013 full development scenario in both the AM and PM peaks.

The Camp Road/Unnamed Road towards the B430 priority junction immediately east of Upper Heyford airfield operates just above its capacity for the right turn from the Unnamed Road in the AM peak. It is well within capacity in the PM peak.

The signalised crossroads junction of the B4030 with the B430 at Middleton Stoney operates within its theoretical capacity threshold in the PM and just above its theoretical capacity threshold in the AM when the proposed improvements to staging and geometry are applied. Under this scenario the impact of the development is nil detriment.

10.8 Sensitivity Test

10.8.1 Alternative Distribution

At the request of Oxfordshire County Council an exercise was undertaken to compare the predicted distribution of the 2013 full development traffic with the distribution used for the previous (2000) planning application as detailed in the 'Agreed Statement on Highways and Transportation Matters May 2002'.

The results of the exercise were reviewed with Oxfordshire County Council. For most locations the distribution was similar and it was agreed that one tended to verify the other. The main variation between the two distributions related to the routing to/from Bicester. Both distributions had just fewer than 30% of trips to Bicester but the 2007 application placed all of these along the main road via Middleton Stoney whereas the previous distribution put two-thirds of Bicester trips along the unclassified minor road from Ardley via Bucknell.

The current (2007) distribution has been used for the following reasons and provides a robust set of data for analysis of the Middleton Stoney junction:

- the Middleton Stoney route is more direct, particularly for trips to Bicester Village or the town centre;
- the 2007 routing was developed taking account of local knowledge of the routes etc; and
- Bucknell village has been traffic calmed since 2000 which has increased journey times slightly.

It was agreed that a sensitivity test using PICADY be undertaken for an alternative distribution of traffic travelling to and from Bicester for the 2013 base plus full development scenario during the AM and PM peak periods. The test applied 50% of the generated traffic

via Middleton Stoney and 50% via Bucknell. Traffic flows based on the alternative distribution to Bicester are illustrated in **Figure 24** and **Figure 25**.

The alternative distribution was tested on three junctions:

- a) B430 Ardley Road/Unnamed Road towards Camp Road priority junction;
- b) Camp Road/Unnamed Road towards the B430 priority junction; and
- c) The signalised crossroads junction of the B4030 with the B430 at Middleton Stoney

The results showed that the two priority junctions performed slightly less well under the alternative distribution. Under the original distribution the B430 Ardley Road/Unnamed Road junction operates well within its capacity threshold and the Camp Road/Unnamed Road operates slightly above its theoretical capacity threshold. Under the alternative distribution, the B430 Ardley Road/Unnamed Road priority junction performed slightly worse. The Camp Road/Unnamed Road priority junction however, suffered severe capacity problems although this situation could be overcome by altering the priority to make the Unnamed Road to Middleton Stoney the minor arm.

The signalised crossroads junction of the B4030 with the B430 at Middleton Stoney performed better with the alternative distribution, with all arms and movements operating within the theoretical capacity threshold.

The results of both distributions in terms of junction capacity are presented below.

10.8.2 B430 Ardley Road - Unnamed Road towards Camp Road

The operation of the B430 Ardley Road/Unnamed Road priority junction towards Road has been tested using PICADY 5 for the weekday 2013 base plus full development flows for the alternative distribution. A summary of the analysis results is shown in Table 10.8 and detailed analysis is given in **Appendix D**.

Table 10.8: B430 Ardley Road – Unnamed Road – PICADY results for 2013 Base plus Full Development Flows and with alternative distribution

| Junction Arm Turning Movement | 2013 Base Plus Dev AM Peak | | 2013 Base Plus Dev PM Peak | | Alternative Distribution 2013 Base Plus Dev AM Peak | | Alternative Distribution 2013 Base Plus Dev PM Peak | |
|--|----------------------------------|--------------|----------------------------------|--------------|---|--------------|---|--------------|
| | Max. RFC | Max Queue | Max RFC | Max Queue | Max. RFC | Max Queue | Max RFC | Max Queue |
| Unnamed Road (Left) | 0.486 | 1 | 0.699 | 2 | 0.679 | 2 | 0.859 | 5 |
| Unnamed Road (Right) | 0.000 | 0 | 0.006 | 0 | 0.000 | 0 | 0.015 | 0 |
| B430 Ardley Road (N) (All Movements) | 0.755 | 3 | 0.489 | 1 | 0.889 | 9 | 0.676 | 2 |

The alternative distribution has resulted in slight changes in the maximum RFC's and maximum queues as shown in Table 10.8 above. In the 2013 base plus full development AM peak hour, the junction operates at slightly above its theoretical capacity threshold (RFC of 0.85) with a queue of 8 predicted for the Unnamed Road right turn and a queue of 9

predicted for B430 Ardley Road. In both scenarios, the junction operates well within its theoretical capacity threshold (RFC of 0.85) in the 2013 base plus full development PM peak hour.

10.8.3 Camp Road - Unnamed Road towards B430

The operation of the Camp Road/Unnamed Road priority junction has been tested, using PICADY 5, for the 2013 weekday base and base plus full development flows for the alternative distribution. A summary of the analysis results is shown in Table 10.9 and detailed analysis is given in **Appendix D**.

In the 2013 base plus full development scenario the alternative distribution has resulted in an increase in the maximum RFC's and maximum queues as shown in Table 10.8. During the PM peak hour the junction operates well within its theoretical capacity threshold (RFC of 0.85) with and without the alternative distribution. During the AM peak hour, however, the junction operates at its theoretical capacity threshold with the original distribution but well over its theoretical capacity threshold with the alternative although this situation could be overcome by altering the priority to make the Unnamed Road to Middleton Stoney the minor arm.

Table 10.9: Camp Road - Unnamed Road – PICADY results for 2013 Base and 2013 Base Plus Full Development Flows

| Junction Arm Turning Movement | 2013 Base Plus Dev AM Peak | | 2013 Base Plus Dev PM Peak | | Alternative Distribution 2013 Base Plus Dev AM Peak | | Alternative Distribution 2013 Base Plus Dev PM Peak | |
|---|----------------------------------|--------------|----------------------------------|--------------|---|--------------|---|--------------|
| | Max. RFC | Max Queue | Max RFC | Max Queue | Max RFC | Max Queue | Max RFC | Max Queue |
| Unnamed Road from B430 (Left) | 0.546 | 1 | 0.012 | 0 | 1.034 | 2 | 0.021 | 0 |
| Unnamed Road from B430 (Right) | 0.926 | 8 | 0.629 | 2 | 1.022 | 19 | 0.802 | 4 |
| Unnamed Road from Middleton Stoney (S) (All Movements) | 0.021 | 0 | 0.047 | 0 | 0.021 | 0 | 0.047 | 0 |

10.8.4 B4030 with the B430 at Middleton Stoney

The operation of the improved junction has been tested with proposed staging and revised geometry using LINSIG for the 2013 weekday base plus full development flows with the alternative distribution. A summary of the analysis results is shown in Table 10.10 and detailed analysis is given in **Appendix I**.

Under the alternative distribution the maximum Degree of Saturation and queue lengths are reduced for all arms and the junction operates within the theoretical capacity threshold.

Table 10.10: B4030 with the B430 junction at Middleton Stoney – LINSIG results for 2013 Base plus Full Development Flows with Proposed Staging and Geometry Improvements

| Junction Arm Turning Movement | 2013 Base Plus Dev AM Peak | | 2013 Base Plus Dev PM Peak | | Alternative Distribution 2013 Base Plus Dev AM Peak | | Alternative Distribution 2013 Base Plus Dev PM Peak | |
|--|----------------------------------|-------------------------------|----------------------------------|-------------------------------|---|-------------------------------|---|-------------------------------|
| | Deg of Sat (%) | Mean Max Queue (PCU) | Deg of Sat (%) | Mean Max Queue (PCU) | Deg of Sat (%) | Mean Max Queue (PCU) | Deg of Sat (%) | Mean Max Queue (PCU) |
| B4030 East (W/B) Left Ahead Right | 97.4 | 22 | 90.0 | 17 | 86.0 | 14 | 76.6 | 12 |
| B430 Ardley Road South (N/B) Right Left Ahead | 59.4 | 11 | 89.0 | 21 | 52.6 | 10 | 78.8 | 18 |
| B4030 West (E/B) Ahead Right Left | 99.6 | 32 | 89.8 | 21 | 86.8 | 19 | 78.2 | 15 |
| B430 Ardley Road North (S/B) Left Ahead Right | 98.7 | 30 | 56.7 | 10 | 87.0 | 21 | 50.0 | 9 |

11 M40 Motorway Junction 10 (B430 roundabout)

11.1 Junction Analysis

Discussions were held with the Highways Agency and Oxfordshire County Council regarding the impact of the proposed development on Junctions 9 and 10 of the M40. Projected impacts on Junction 9 were very slight and therefore the Highways Agency and Oxfordshire County Council did not require analysis of this junction.

It was agreed that Junction 10 of the M40 (B430 roundabout only) would be tested in the 2013 base and 2013 base plus full development scenarios. It was also agreed that this part of Junction 10 would be tested as a 'stand alone' junction in a free-flow situation without taking account of existing congestion which sometimes blocks back from the far side of Junction 10. The Highways Agency has recently introduced traffic signals on the northernmost roundabout of Junction 10 to address this problem.

11.2 Design years

An opening year of 2013 has been agreed with the Highways Agency and Oxfordshire County Council. The Highways Agency requested a further test of M40 Junction 10 at 15 years after opening year (2028).

11.3 Traffic flows

Traffic flow diagrams for Junction 10 are included in the Figures section for five scenarios:

- **Figure 13:** 2006 base AM
- **Figure 14:** 2006 base PM
- **Figure 15:** 2013 base AM
- **Figure 16:** 2013 base PM
- **Figure 17:** 2013 base plus full development AM
- **Figure 18:** 2013 base plus full development PM
- **Figure 19:** 2028 base AM
- **Figure 20:** 2028 base PM
- **Figure 21:** 2028 base plus full development AM
- **Figure 22:** 2028 base plus full development PM

All traffic flows are for an average weekday.

11.4 2013 Base Year Traffic

The 2013 base represents the 2006 base with background traffic growth applied up to the opening year of 2013. The 2006 base represents traffic flows on the network with all traffic generated by the existing Heyford Park development removed. Background traffic growth from base year to opening year has been calculated using NRTF Central Case adjusted by TEMPRO local forecasts for Cherwell Rural and Bicester. This produces a growth factor of 12.7% (AM) and 12.8% (PM) over the period. The traffic growth calculations are contained in **Appendix H**.

The operation of the Junction 10 (B430 roundabout) junction has been tested using ARCADY 6 for the 2013 AM and PM weekday base. A summary of the analysis results is shown in Table 11.1 and detailed analysis is given in **Appendix E**.

In the weekday 2013 base AM peak the junction has a maximum RFC of 0.760 on the M40 slips approach for all movements, with a queue of 3 predicted.

In the weekday 2013 base PM peak the maximum RFC rises to 0.855 on the M40 slips approach for all movements, with a queue of 6 predicted.

In summary, the junction operates within its theoretical capacity threshold (RFC of 0.85) in the 2013 base AM peak period and at its theoretical capacity threshold in the PM peak.

Table 11.1: Junction 10 (B430 roundabout) - ARCADY results for 2013 Base

| Junction Arm Turning Movement | 2013 Base AM Peak | | 2013 Base PM Peak | |
|-------------------------------------|-------------------|-----------|-------------------|-----------|
| | Max. RFC | Max Queue | Max RFC | Max Queue |
| A43 (All Movements) | 0.529 | 1 | 0.302 | 0 |
| M40 Slips (All Movements) | 0.760 | 3 | 0.855 | 6 |
| B430 (All Movements) | 0.309 | 0 | 0.324 | 0 |

11.5 2013 Opening Year Traffic

The 2013 full development represents the 2013 base with Heyford Park full development traffic added.

The operation of the Junction 10 (B430 roundabout) junction has been tested using ARCADY 6 for the 2013 AM and PM weekday base plus full development scenario. A summary of the analysis results is shown in Table 11.2 and detailed analysis is given in **Appendix E**.

Table 11.2 Junction 10 (B430 roundabout) - ARCADY results for 2013 Base plus Full Development

| Junction Arm Turning Movement | 2013 Base Plus Dev AM Peak | | 2013 Base Plus Dev PM Peak | |
|-------------------------------------|----------------------------|-----------|----------------------------|-----------|
| | Max. RFC | Max Queue | Max RFC | Max Queue |
| A43 (All Movements) | 0.697 | 2 | 0.416 | 1 |
| M40 Slips (All Movements) | 0.886 | 7 | 0.935 | 12 |
| B430 (All Movements) | 0.508 | 1 | 0.627 | 2 |

In the weekday 2013 base plus full development AM peak the junction has a maximum RFC of 0.886 on the M40 slips approach for all movements, with a queue of 7 predicted.

In the weekday 2013 base plus full development PM peak the junction has a maximum RFC of 0.935 on the M40 slips approach for all movements, with a queue of 12 predicted.

In summary, the junction operates at its theoretical capacity threshold (RFC of 0.85) in the 2013 base plus full development AM and just above its theoretical capacity threshold in the PM peak periods.

11.6 2028 Base Year Traffic

The 2028 base represents the 2006 base with background traffic growth applied up to 2028; which is opening year plus 15 years. Background traffic growth from base year to 2028 has been calculated using NRTF Central Case adjusted by TEMPRO local forecasts for Cherwell Rural and Bicester. This produces a growth factor of 22.7% (AM) and 23.7% (PM) over the period. The traffic growth calculations are contained in **Appendix H**.

The operation of the Junction 10 (B430 roundabout) junction has been tested using ARCADY 6 for the 2028 AM and PM weekday base. A summary of the analysis results is shown in Table 11.3 and detailed analysis is given in **Appendix E**.

In the weekday 2028 base AM peak the junction has a maximum RFC of 0.847 on the M40 slips approach for all movements, with a queue of 5 predicted.

In the weekday 2028 base PM peak the junction has a maximum RFC of 0.947 on the M40 slips approach for all movements, with a queue of 14 predicted.

In summary, the junction operates within its theoretical capacity threshold (RFC of 0.85) in the 2028 base AM peak period and just above its theoretical capacity threshold in the PM peak.

Table 11.3: Junction 10 (B430 roundabout) - ARCADY results for 2028 Base

| Junction Arm Turning Movement | 2028 Base AM Peak | | 2028 Base PM Peak | |
|-------------------------------------|-------------------|-----------|-------------------|-----------|
| | Max. RFC | Max Queue | Max RFC | Max Queue |
| A43 (All Movements) | 0.579 | 1 | 0.332 | 0 |
| M40 Slips (All Movements) | 0.847 | 5 | 0.947 | 14 |
| B430 (All Movements) | 0.352 | 1 | 0.380 | 1 |

11.7 2028 Full Development Traffic

The 2028 full development represents the 2028base with Heyford Park full development traffic added.

The operation of the Junction 10 (B430 roundabout) junction has been tested using ARCADY 6 for the 2028 AM and PM weekday base plus full development scenario. A summary of the analysis results is shown in Table 11.4 and detailed analysis is given in **Appendix E**.

In the weekday 2028 base plus full development AM peak the junction has a maximum RFC of 0.987 on the M40 slips approach for all movements, with a queue of 23 predicted.

In the weekday 2013 base plus full development PM peak the junction has a maximum RFC of 1.036 on the M40 slips approach for all movements, with a queue of 50 predicted.

Table 11.4 Junction 10 (B430 roundabout) - ARCADY results for 2028 Base plus Full Development

| Junction Arm Turning Movement | 2028 Base Plus Dev AM Peak | | 2028 Base Plus Dev PM Peak | |
|-------------------------------------|----------------------------|-----------|----------------------------|-----------|
| | Max. RFC | Max Queue | Max RFC | Max Queue |
| A43 (All Movements) | 0.750 | 3 | 0.447 | 1 |
| M40 Slips (All Movements) | 0.987 | 22 | 1.036 | 50 |
| B430 (All Movements) | 0.556 | 1 | 0.686 | 2 |

In summary, the junction no longer operates within its theoretical capacity threshold (RFC of 0.85) in the 2028 base plus full development AM and PM peak periods although it is only the M40 northbound off slip approach to the junction that exceeds capacity.

11.7.1 Mitigation Measures

Analysis of the junction layout was undertaken and it was found that minor changes to the carriageway markings could mitigate the impact of the development traffic. No changes to the carriageway alignments were required. Details of the existing markings and proposed improvements are provided in **Figure 36**.

The operation of the Junction 10 (B430 roundabout) junction has been tested using ARCADY 6 for the 2028 AM and PM weekday base plus full development scenario with revised carriageway markings. A summary of the analysis results is shown in Table 11.5 and detailed analysis is given in **Appendix E**.

Table 11.5 Junction 10 (B430 roundabout) - ARCADY results for 2028 Base plus Full Development with revised carriageway markings

| Junction Arm Turning Movement | 2028 Base Plus Dev AM Peak | | 2028 Base Plus Dev PM Peak | |
|-------------------------------------|----------------------------|-----------|----------------------------|-----------|
| | Max. RFC | Max Queue | Max RFC | Max Queue |
| A43 (All Movements) | 0.750 | 3 | 0.447 | 1 |
| M40 Slips (All Movements) | 0.778 | 3 | 0.831 | 5 |
| B430 (All Movements) | 0.561 | 1 | 0.709 | 2 |

With the mitigation in place the junction has a maximum RFC of 0.778 in the weekday 2028 base plus full development AM peak on the M40 slips approach for all movements, with a queue of 3 predicted.

In the weekday 2013 base plus full development PM peak the junction has a maximum RFC of 0.831 on the M40 slips approach for all movements, with a queue of 5 predicted.

In summary, with the proposed mitigation measures the junction operates within its theoretical capacity threshold in the 2028 base plus full development AM and PM peaks.

12 Site Access

12.1 Junctions on Camp Road

Access into the development will be gained from Camp Road via a series of existing and new access roads. The development masterplan envisages that junctions in the middle of the settlement that provide access from Camp Road into the development will consist of raised tables comprising shared use road surface without road markings or signs specifying priority. These arrangements are consistent with the Manual for Streets.

Site access arrangements are shown in **Figures 26 to 30**.

The following ten junctions will provide access into the settlement from Camp Road. From east to west:

- The Camp Road/Larsen Road junction will be retained as a priority junction with its existing geometry and will provide access to new and existing areas of housing. The entrance to the caravan site will remain opposite Larsen Road, on the south side of Camp Road with its geometry and priority;
- Soden Road is a short cul-de-sac to the north of Camp Road. The Camp Road/Soden Road junction will be retained as a priority junction with its existing geometry and will provide access to the existing houses. Opposite Soden Road, a new minor junction will provide access to 8 dwellings;
- Approximately 75m west of Soden Road a new access will be formed to join Camp Road on its north side at a priority junction. This will provide the main access to the commercial areas of the development and will be the designated HGV access.
- Some 40m to the west a new minor junction on the south side of Camp Road will provide access to 13 dwellings;
- The existing main gate access to the north side of Camp Road will be retained but reduced to 6m. This will provide access to a mixed residential/commercial area. Opposite the main gate, on the south side of Camp Road a new road of 6.5m width will form a cross roads junction with Camp Road and the main gate and provide access to the main housing area. This junction will be formed on a raised table comprising shared use road surface without road markings or signs specifying priority;
- The existing Dow Street/Camp Road priority junction will be reconstructed on a raised table comprising shared use road surface without road markings or signs specifying priority. Dow Street will be reduced in width to 5.4m at its northern end in line with the current road width further south and will provide access into an area of new and retained housing;
- Approximately 60m to the west a new access to a car park serving the proposed Heritage Centre and part of the commercial development will be formed to join Camp Road on its north side. The junction will be constructed on a raised table comprising shared use road surface without road markings or signs specifying priority;
- The existing Dacey Drive/Camp Road priority junction will be reconstructed and Darcy Drive will be reduced in width to 6.5m. Opposite Dacey Drive, on the north side of Camp Road a new road of 4.8m width will form a cross roads junction with Camp Road and Dacey Drive. This junction will be formed on a raised table comprising shared use road surface without road markings or signs specifying priority. Both north and south arms of the junction will provide access to new housing areas; and
- A new 4.8m wide access road to the housing area will be formed to join Camp Road on its north side. This will be the westernmost junction in the settlement and will be

constructed on a raised table comprising shared use road surface without road markings or signs specifying priority.

12.2 Junction Tests

The operation of three Camp Road junctions that give access to the new development were tested for the 2013 full development scenario. The Figures section contains traffic flow diagrams for the Camp Road junctions for the 2013 base plus full development AM (**Figure 33**) and the 2013 base plus full development PM (**Figure 34**).

12.2.1 Camp Road – Larsen Road

The operation of the Camp Road/Larsen Road priority junction has been tested using PICADY 5 for the 2013 weekday base plus full development flows. A summary of the analysis results is shown in Table 12.1 and detailed analysis is given in **Appendix F**.

Table 12.1: Camp Road – Larsen Road – PICADY results for 2013 Base plus Full Development Flows

| Junction Arm Turning Movement | 2013 Base Plus Dev AM Peak | | 2013 Base Plus Dev PM Peak | |
|-----------------------------------|-------------------------------|-----------|-------------------------------|-----------|
| | Max. RFC | Max Queue | Max RFC | Max Queue |
| Larsen Road (N) Ahead + Left | 0.027 | 0 | 0.014 | 0 |
| Larsen Road (N) Ahead + Right | 0.023 | 0 | 0.011 | 0 |
| Camp Road (W) All Movements | 0.003 | 0 | 0.016 | 0 |
| Unnamed Road (S) Ahead + Left | 0.013 | 0 | 0.002 | 0 |
| Unnamed Road (S) Ahead + Right | 0.038 | 0 | 0.008 | 0 |
| Camp Road (E) All Movements | 0.010 | 0 | 0.033 | 0 |

From Table 12.1 it can be seen that in the 2013 base plus full development AM peak the junction has a maximum RFC of 0.038 for the ahead and right movements from the Unnamed Road serving the caravan park (S), with no queuing predicted. In the PM peak the junction has a maximum RFC of 0.033 for all movements from Camp Road (E), with no queuing predicted.

In summary, it can be seen from Table 12.1 that the junction operates well within its theoretical capacity threshold (RFC of 0.85) in the 2013 base plus full development scenario during the AM and PM peak hours.

12.2.2 Camp Road – Soden Road

The Camp Road/Soden Road priority junction carries significantly less traffic than the Camp Road/Larsen Road junction and as the latter operates well within its theoretical capacity threshold in the 2013 base plus full development scenario during the AM and PM peak hours it can be deduced that the former junction will also operate satisfactorily.

12.2.3 Camp Road – HGV Access Road

The operation of the Camp Road/HGV Access Road priority junction has been tested using PICADY 5 for the 2013 weekday base plus full development flows. A summary of the analysis results is shown in Table 12.2 and detailed analysis is given in **Appendix F**.

Table 12.2: Camp Road – HGV Access Road – PICADY results for 2013 Base plus Full Development Flows

| Junction Arm Turning Movement | 2013 Base Plus Dev AM Peak | | 2013 Base Plus Dev PM Peak | |
|----------------------------------|-------------------------------|-----------|-------------------------------|-----------|
| | Max. RFC | Max Queue | Max RFC | Max Queue |
| HGV Access Road (Left) | 0.317 | 0 | 0.647 | 2 |
| HGV Access Road (Right) | 0.374 | 1 | 0.576 | 1 |
| Camp Road (E) (All Movements) | 0.702 | 2 | 0.280 | 0 |

In the weekday AM peak the junction has a maximum RFC of 0.702 on the Camp Road (E) approach for all movements, with a maximum queue of 2 predicted. In the weekday PM peak the junction has a maximum RFC of 0.647 on the HGV Access Road approach for the left turn, with a maximum queue of 2 predicted.

In summary, it can be seen from Table 7.2 that the junction operates well within its theoretical capacity threshold (RFC of 0.85) in the 2013 base plus full development scenario during both the AM and PM peak hours.

12.2.4 Camp Road – Main Gate

It is proposed that the remaining junctions providing access to the development will consist of raised tables comprising shared use road surface without road markings or signs specifying priority. Without conventional geometry and road markings it is not possible to test the operation of the junctions in the usual way. Instead, the Camp Road/Main Gate junction, which, of the remaining ones has the greatest traffic flows in the 2013 full development scenario, has been tested twice using PICADY 5 and assumed geometry. In the first test priority was applied to the east-west flows on Camp Road and in the second test priority was applied north-south.

A summary of the analysis results is shown in Tables 12.3 and 12.4 and detailed analysis is given in **Appendix F**.

12.2.4.1 East-West Priority

The operation of the Camp Road/Main Gate/New Road junction has been tested using PICADY 5 for the 2013 weekday base plus full development flows with east-west priority.

The results are shown in Table 12.3. From the table it can be seen that in the 2013 base plus full development AM peak the junction has a maximum RFC of 0.415 for the ahead and right movements from the New Access opposite the Main Gate (S), with a queue of 1 predicted. In the PM peak the junction has a maximum RFC of 0.238 for all movements from Camp Road (E), with a maximum queue of 1 predicted.

In summary, it can be seen from Table 12.3 that with priority given to east-west movements the junction operates well within its theoretical capacity threshold (RFC of 0.85) in the 2013 base plus full development scenario during the AM and PM peak hours.

Table 12.3: Camp Road – Main Gate – PICADY results for 2013 Base Plus Full Development Flows with east-west priority traffic flows

| Junction Arm Turning Movement | 2013 Base Plus Dev AM | | 2013 Base Plus Dev PM | |
|----------------------------------|-----------------------|-----------|-----------------------|-----------|
| | Max RFC | Max Queue | Max RFC | Max Queue |
| Main Gate (N) Ahead + Left | 0.176 | 0 | 0.265 | 0 |
| Main Gate (N) Ahead + Right | 0.132 | 0 | 0.197 | 0 |
| Camp Road (W) All Movements | 0.035 | 0 | 0.106 | 0 |
| New Access (S) Ahead + Left | 0.087 | 0 | 0.040 | 0 |
| New Access (S) Ahead + Right | 0.415 | 1 | 0.214 | 0 |
| Camp Road (E) All Movements | 0.393 | 1 | 0.238 | 1 |

12.2.4.2 North-South Priority

The operation of the Camp Road/Main Gate/New Road junction has been tested using PICADY 5 for the 2013 weekday base plus full development flows with north-south priority. The results are shown in Table 12.4.

Table 12.4: Camp Road – Main Gate – PICADY results for 2013 Base Plus Full Development Flows with north-south priority traffic flows

| Junction Arm Turning Movement | 2013 Base Plus Dev AM | | 2013 Base Plus Dev PM | |
|----------------------------------|-----------------------|-----------|-----------------------|-----------|
| | Max RFC | Max Queue | Max RFC | Max Queue |
| Camp Road (W) Ahead + Left | 0.746 | 3 | 0.416 | 1 |
| Camp Road (W) Ahead + Right | 0.473 | 1 | 0.331 | 0 |
| New Access (S) All Movements | 0.239 | 0 | 0.114 | 0 |
| Camp Road (E) Ahead + Left | 0.421 | 1 | 0.774 | 3 |
| Camp Road (E) Ahead + Right | 0.605 | 1 | 0.499 | 1 |
| Main Gate (N) All Movements | 0.084 | 0 | 0.150 | 0 |

From Table 12.4 it can be seen that in the 2013 base plus full development AM peak the junction has a maximum RFC of 0.746 for the ahead and left movements from Camp Road (W), with a maximum queue of 3 predicted. In the PM peak the junction has a maximum RFC of 0.774 for the ahead and left movements from Camp Road (E), with a maximum queue of 3 predicted.

In summary, it can be seen from Table 12.4 that with priority given to north-south movements the junction operates well within its theoretical capacity threshold (RFC of 0.85) in the 2013 base plus full development scenario during the AM and PM peak hours.

12.3 Summary

The operation of three of the ten junctions that will provide access to Heyford Park from Camp Road were tested for capacity during the 2013 base plus full development scenario. The tested junctions are those that will experience the heaviest traffic flows and conflicting movements. All three perform well within their theoretical capacity which indicates that the other, less used junctions will also operate satisfactorily.

13 Accidents

13.1 Area

An area for the collection of accident data was agreed with Oxfordshire County Council which encompassed all roads in the area but excluded accidents on the M40 main carriageways. The area covered is shown in **Figure 31**.

13.2 Methodology

Accidents were grouped into the links and junctions depending on where they occurred and any links and junctions exceeding an accident rate of one accident per year were investigated further. A comparison to the predicted COBA rate was undertaken to ascertain if the observed rate exceeded the predicted accident rate. All personal injury accidents involving a vulnerable road user were investigated regardless of the total accident rate on the link/junction where they occurred.

A summary was generated detailing the number of accidents, number of casualties and severities and from these the accidents were plotted on a local road network map with details of their severity and type to clearly display any accident clusters.

13.3 Accident Data

Data for personal injury accidents was obtained from Oxfordshire County Council for roads in the vicinity of the development for the period between 1st August 2001 and 31st July 2006. Partial data was supplied rather than the full Stats 19 data. The area covered, the location, the severity and numbers of recorded accidents are shown on **Figure 31**. The data shows that within the study area 147 personal injury accidents were recorded within the five year period analysed (plus a further 12 on the M40 main carriageways which were not analysed). Copies of the accident records are included in **Appendix G**.

Of the 147 accidents, six involved vulnerable road users. Of the six, four involved pedestrians of which two were fatal, one serious and one slight in terms of severity. The remaining two vulnerable road user accidents involved cyclists, with both of them resulting in injuries of slight severity. All other recorded personal injury accidents were solely vehicular.

During the scoping stage it was agreed with Oxford County Council that links or junctions where the accident rate exceeds one per annum will be investigated plus all accidents involving vulnerable road users regardless of the localised accident rate.

The analysis shows that over the study area there are five locations; one link and four junctions that have an accident rate greater than one accident per annum. Only one vulnerable road user, a cyclist, was injured at these accident clusters. Junctions or links where the accident rate exceeds one per annum are shown in Table 13.1.

Table 13.1: Accidents Occurring at Junctions (+20m surrounding the junction)

| Junction / Link Location | Number of Accidents in 5 year period | | | | | | | | |
|--|--------------------------------------|---|----|---------|---|----|------------|---|----|
| | Vehicle | | | Cyclist | | | Pedestrian | | |
| | F | S | SL | F | S | SL | F | S | SL |
| B4030 / A4260 Hopcrofts Holt Junction | 1 | 1 | 7 | 0 | 0 | 0 | 0 | 0 | 0 |
| B430 Ardley Road – Between Heyford Park turn and Church Road, Ardley | 0 | 4 | 5 | 0 | 0 | 0 | 0 | 0 | 0 |
| M40 Junction 10 - B430 Roundabout | 0 | 3 | 10 | 0 | 0 | 0 | 0 | 0 | 0 |
| M40 Junction 10 - Cherwell Roundabout | 0 | 4 | 18 | 0 | 0 | 1 | 0 | 0 | 0 |
| M40 Junction 10 - Padbury Brook Roundabout | 0 | 1 | 10 | 0 | 0 | 0 | 0 | 0 | 0 |

Note: F denotes accident involving a fatality, S denotes accident involving a serious injury and SL denotes accident involving a slight injury.

13.4 Analysis

The following accident analysis considers each of the five clusters relative to the predicted COBA accident rate.

13.4.1 B4030 / A4260 Hopcrofts Holt Junction

Nine personal injury accidents have been recorded at the Hopcrofts Holt signalised junction during the five year period analysed. None of the accidents involved vulnerable road users. The accidents have resulted in one fatality, one serious severity and seven slight severity injury accidents.

The fatality was considered to be due to excessive speed resulting in the driver losing control on approach to the junction. A COBA analysis was undertaken to ascertain the predicted accident rate for this type of junction with the existing traffic flows. The COBA predicted accident rate of 2 accidents per annum is higher than the observed rate of 1.8 accidents per annum; therefore it is considered that there is no inherent accident problem at this location.

13.4.2 B430 Ardley Road – Between Heyford Park turn and Church Road, Ardley

This link has had nine personal injury accidents recorded during the five year period analysed. There are several minor accesses along this link. At two of these accesses there have been three personal injury accidents recorded; two at one access and one at the other. These junctions are therefore within the 1 accident per annum threshold and independent of the link.

The link itself however, has an actual accident rate of less than 1.2 accidents per annum and therefore further analysis is required to determine whether or not there are any specific factors that are contributing to the higher accident rate.

13.4.3 M40 Junction 10 - B430 Roundabout

The most southerly of the three roundabouts that form Junction 10 shows a cluster of 13 personal injury accidents. Of these accidents, 12 involved heavy goods vehicles, with ten of them overturning whilst navigating the roundabout. The HGVs appear to be travelling too fast for the roundabout, which has an adverse camber; additionally some are stated to have been poorly loaded. The data recorded one vehicle being driven by a foreign driver. Signage on the slip road approach to the roundabout from the M40 east indicates that there

is a risk of overturning due to adverse camber and the accident record will need to be kept under review to monitor effectiveness of this signage.

13.4.4 M40 Junction 10 - Cherwell Roundabout

Cherwell Roundabout is the centre roundabout of the three that form Junction 10. For clarity, it was investigated in three sections; the circulating section, the link to Padbury Brook roundabout and the link from Padbury Brook roundabout.

Only four personal injury accidents have been recorded circulating the Cherwell roundabout, all resulting in slight severity injuries. These four accidents were due to a mixture of causations including excessive speed, poor loading of vehicle and poor lane discipline.

There have been nine personal injury accidents recorded on the southbound link towards Cherwell roundabout on the A43 from Padbury roundabout.

There have been ten personal injury accidents recorded on the northbound link on the A43 in the vicinity of Cherwell roundabout heading towards Padbury Brook roundabout.

13.4.5 M40 Junction 10 - Padbury Brook Roundabout

There have been eleven personal injury accidents recorded at the Padbury Brook roundabout during the five year period analysed. Two of these were attributed to a spillage on the surface causing drivers to lose control of their vehicle. Of the remaining nine accidents, four involved HGVs, all resulting in slight severity injuries and five involved cars, with four slight severity injuries and one serious severity injury. Two accidents were of a shunt nature, resulting in slight severity injuries. The remaining seven accidents were a result of drivers crossing each other's path and either colliding or overturning as a result of swerving out of the oncoming vehicles path. Traffic signals have now been introduced at this junction which should help to reduce the tendency for this type of accident to occur.

13.4.6 M40 Junction 10 Summary

The number of accidents at the roundabouts and links that form Junction 10 exceeds the predicted COBA analysis accident rate of 1 accident per annum and therefore further analysis is required to identify any specific causation factors which could be remedied.

13.5 Accidents Involving Vulnerable Road Users

13.5.1 Pedal Cyclists

There have been two accidents involving pedal cyclists outside of the clusters already discussed. One of these accidents occurred in Camp Road where a motor vehicle clipped a cyclist resulting in a slight severity injury. The other accident involving a pedal cyclist occurred in North Street, Fritwell where, following an argument between a pedal cyclist and a HGV driver, the pedal cyclist was knocked off his cycle by the HGV.

13.5.2 Pedestrians

There have been four accidents involving pedestrians outside the clusters already discussed. One of these occurred outside the Old Inn, in Somerton, where a woman was found lying in the road. She claimed that a driver had hit her and left the scene, however it has to be noted that the woman had been drinking.

One accident occurred in Castle Fields Road, Ardley during snow and ice conditions where a driver was reversing slowly out of their drive and hit a small child playing in the snow, resulting in a serious severity injury.

Two accidents involving pedestrians occurred at different junctions along Station Road (B430) in the vicinity of Ardley, both resulting in fatal injuries. The first involved a pedestrian, believed to be intoxicated, who fell into the path of a vehicle resulting in fatal injuries. The second was the result of a pedestrian stepping out into the path of an oncoming vehicle resulting in a fatal injury. Both accidents can therefore be attributed to an error by the pedestrian.

13.6 Conclusions

In conclusion, the analysis shows that over the study area there are five locations; one link and four junctions, that have an accident rate greater than one accident per annum;

- B430 south of Ardley;
- Hopcrofts Holt junction;
- M40 Junction 10 southern (B430) roundabout;
- M40 Junction 10 centre (Cherwell) roundabout; and
- M40 Junction 10 northern (Padbury Brook) roundabout.

There were a total of seven accidents involving vulnerable road users, six of which were outside the identified accident clusters.

The predicted COBA analysis accident rate was exceeded at the B430 between Church Road, Ardley and the junction with the unnamed road towards Heyford Park and at the three roundabouts that together form Junction 10 of the M40. It is recommended that Oxfordshire County Council undertake further analysis of the records related to these accidents to determine any common causation factors and identify mitigation measures.

14 Village Traffic Calming

14.1 Existing Traffic Calming

Prior to submission of a previous planning application in 2000 to develop Heyford Park, concerns were raised by local politicians and members of the public about the possible impact of traffic associated with the development on local villages. Following consultation with the highway authority and a range of stakeholders, traffic calming schemes were proposed for nine local villages.

In the period since 2000, although the proposed development did not go ahead, traffic calming measures were introduced in a number of villages as part of Oxfordshire County Council's wider policies for managing traffic on rural roads.

Traffic calming measures, outlined below, are located in the following villages:

- **North Aston** has rumble strips at village approaches;
- **Somerton** has are entry treatments, narrowings and priority markings on the roads from Ardley, Fritwell and Upper Heyford. There is a speed cushion on Upper Heyford Road;
- In **Upper Heyford** 30mph roundel markings on a red carriageway surface have been applied on all entries to village;
- **Middleton Stoney** has gateway features and 30mph roundels on red carriageway surfacing on the B430 entries to the village;
- In **Lower Heyford** there are gateway features and 30mph roundels on carriageway surface on entries to the village;
- **Steeple Aston** has 30mph roundels on carriageway surfaces on entries to the village;
- **Middle Aston** is without traffic calming features;
- In **Kirtlington** there is an entry feature island and speed humps on northern approach to the village and a small narrowing in centre;
- **Fritwell** is without traffic calming features;
- **Ardley** is without traffic calming features;
- **Bucknell** has speed hump entry features and aggressive speed humps throughout the village on the main through road; and
- **The Bartons** has gateway features and 30mph roundels on red carriageway surfaces on entries to the village and red carriageway markings at locations within the village.

14.2 Additional Traffic Calming

Notwithstanding that traffic calming measures have already been implemented in a number of local villages, in order to mitigate the impact of traffic associated with the development, North Oxfordshire Consortium will undertake to investigate the implementation of traffic calming measures as proposed in the 2000 planning application at locations where these have not already been implemented and providing the measures are considered to be necessary by Oxfordshire County Council.

15 Public Transport, Walking and Cycling

15.1 Bus Services

There are three bus stops located within the Heyford Park settlement; all on Camp Road. There is a bus shelter and stop for eastbound services on the north side of Camp Road approximately 150m east of the main gate. A similar distance to the west of the main gate a small loop off of the highway houses a further bus shelter and stop that is currently served by buses going in both directions. A further eastbound stop is located adjacent to the Soden Road junction.

At present, the site is served by a single bus route, the 25/25A/25B from Oxford to Bicester via local villages. This is a tendered service, paid for by Oxfordshire County Council and operated by RH Transport Services. The route is normally operated with low floor, wheelchair accessible vehicles.

The daytime service frequency is approximately one an hour in each direction with an additional service in both directions in the AM peak hour. A number of the off-peak services operate between Bicester and Kidlington only where a connecting bus is available for travel to/from Oxford. Evening services run Friday and Saturday only and there are also additional services to provide school access during term time.

There are no services on Sundays or Public Holidays.

Table 14.1 provides details of the service route and frequencies.

Figure 32 shows the extent of the bus route that serves Heyford Park and the bus stop locations on Camp Road.

Table 15.1: Buses serving Heyford Park

| | |
|-------------------------------|--|
| Bus Service | 25/25A/25B Monday to Saturday |
| Route | Bicester – Kirtlington – Bletchingdon - Oxford |
| Average Time | Bicester – Upper Heyford: 17 minutes Upper Heyford – Oxford: 38 minutes |
| Frequency | 13 daily: Mondays – Thursdays 15 daily: Fridays - Saturdays |
| Departure Times | (07.09, 07.37 Mondays – Thursdays only), (08.00 Saturday only), 10.02, 11.00, 12.00, 14.00, (15.30 School holidays only) 16.05, 18.10, (19.10, 21.10 Friday and Saturday only) |
| Route | Bicester Chesterton, Middleton Stony, Heyford Park , Upper Heyford, Lower Heyford, Kirtlington, Bletchingdon, Hampton Poyle, Gosford, Kidlington Oxford |
| Additional Information | Also service from Upper Heyford to Oxford at 09.11 and 13.11 These require a connection to 59B (Operated by Stagecoach) at Kirtlington Primary School. |

| | |
|-------------------------------|---|
| Bus Service | 25/25A/25B Monday to Saturday |
| Route | Oxford – Bletchingdon – Kirtlington – Bicester |
| Average Time: | Oxford – Upper Heyford: 36 minutes Upper Heyford – Bicester: 15 minutes |
| Frequency | 11 daily Mondays – Thursdays 13 daily Fridays - Saturdays |
| Departure times | (06.55 Mondays – Fridays only) 09.00, 11.00, 13.00, 15.00, 17.05, 18.05 (20.05, 23.20 Fridays – Saturdays only) |
| Route | Oxford , Gosford, Hampton Poyle, Bletchingdon, Kirtlington, Lower Heyford, Upper Heyford, Heyford Park , Middleton Stony, Bicester |
| Additional information | Also service from Oxford at 10.00, 12.00 and 14.00 These require a connection to be made at Kirtlington |

15.2 Bus Service Improvements

Measures to improve local bus services have been discussed with Oxfordshire County Council and will be supported by North Oxfordshire Consortium subject to an appropriate agreement being reached.

The following improvements to the existing service 25, 25A, 25B would be appropriate:

- A service every 30 minutes to Bicester town centre throughout the day;
- An hourly service to Oxford during the AM and PM peaks;
- Some services to connect to Bicester North Station throughout the day; and
- Existing Friday and Saturday evening services extended to rest of the week.

15.3 Rail Services

The nearest railway station to Heyford Park is at Lower Heyford, approximately 4km to the south west. This is served by trains from Banbury to Oxford and provides direct services to those destinations plus a number of other local stations. Weekday and Saturday frequencies vary between 90 minutes and three hours. There are no services on Sunday. At Oxford, changes are available to services to Bristol and the west, Reading and London Paddington, and south coast destinations. Banbury provides interchange with routes to Birmingham and further north, and also to the Chiltern line which runs south east to London via Bicester.

Heyford Park is some 8km from Bicester North station from where up to 4 services per hour run directly to London including Saturdays and Sundays. Some services are non-stop, with a Bicester to London journey time of less than an hour. There is a second station in Bicester, Bicester Town which is located at the end of a branch line from Oxford and is served at approximately 2 hour intervals Mondays to Saturdays. There is no Sunday service.

The 25/25A/25B bus services from Heyford Park travel through Lower Heyford and to Bicester although in both places the nearest bus stops are some distance from the stations.

15.4 Rail Service Improvements

It would be unrealistic to hope to influence rail service provision as such. However, the improvements to local bus services outlined above will enhance access to local stations. Furthermore, discussions have been held with Chiltern Railways related to investigation of a shuttle mini-bus service to serve Bicester North station from Heyford Park.

15.5 Pedestrian and Cycle Facilities

15.5.1 Pedestrian facilities

On the north side of Camp Road, there is a 2m wide pedestrian footway adjacent to the carriageway between the Main Gate and the perimeter of the site at Larsen Road. To the south side of Camp Road, there is a footway set back from the kerb line by some 3m and separated from the carriageway by a verge and hedge/fence. This footway is generally in excess of 2m wide and runs the entire length of Camp Road, where it passes through the site, forming a continuous link from the caravan park at the eastern perimeter to Port Way in the west. A narrower (1m) footway adjacent to the carriageway continues as far as Upper Heyford village. There are no footways accompanying the two other roads out of Upper Heyford nor any on Port Way or Camp Road and its extensions eastwards beyond the edge of the site.

There are no controlled pedestrian crossing points on Camp Road. Dropped kerbs and tactile paving are provided to enable uncontrolled crossing of Camp Road via the splitter islands on the approaches to the Main Gate roundabout.

Street lighting is provided on Camp Road for its entire length through the site.

15.5.2 Cycle facilities

There are no formal cycle routes in the vicinity of the site, the closest being National Cycle Network Route 51 which passes through Bicester and then south to Oxford.

15.6 Pedestrian and Cycle Improvements

15.6.1 Within the Development

Within the settlement pedestrian and cycle movement will be encouraged by the 'permeable' or connected street structure that allows movement through the development without having to travel up and down arbitrary road hierarchies. The environment for walking and cycling will be enhanced by street design that will seek to restrict vehicular movement to 20 mph on most roads. All streets will be designed in detail to allow safe use on dedicated paths or shared surfaces.

It has been a key aim of the masterplan for the neighbourhood to keep the layout of new and retained residential areas well connected and compact. Most people living and working at Heyford Park will be within convenient walking distances of the local shop, community facilities and school. The new neighbourhood centre is equidistant from the furthest housing areas, 640 metres from new housing in the south-west and existing retained housing in the north east. As far as possible, bus stops will be located within 400m of all areas of the site.

The main strategic routes include:

- The landscape belt on the north side of Camp Road which will include a safe cycling and walking route that will be well separated from traffic;
- A strong east-west axis through the neighbourhood centre which picks up all the main facilities and extends into the street pattern;
- A strong north-south axis through the neighbourhood centre, which crosses Camp Road at a controlled crossing to link with routes on the north side; and
- A diagonal route from north-east to south-west, which is designed into the development and will connect to countryside walks outside the neighbourhood itself.

15.6.2 In the Wider Area

The potential for travel to and from Heyford Park on foot or by cycle is limited due to the location of the settlement; most destinations are too distant for all except the most committed pedestrians or cyclists. It is likely that the majority of walking and cycling trips outside of the settlement will be for amenity rather than for travel purposes. The network of footpaths, bridleways and Rights of Way linking the settlement with the wider area are therefore considered in detail within that part of the planning application which deals with landscape and amenity.

The nature of the local highway network, consisting in the main of small-scale country roads with relatively light traffic volumes, provides potential for cycle use but again, it is likely to be for amenity value rather than as a transport mode.

16 Travel Plan

16.1 Introduction

A travel plan is a general term for a package of measures instituted by developers, employers, schools and others to reduce the impact of travel and transport on the environment. They aim to encourage the use of modes other than the car and the car itself in less environmentally damaging ways. The benefits of travel plans are numerous and include reduced traffic congestion and pollution; improved health and reduced stress for residents and employees, better air quality and less carbon dioxide in the environment.

In summer 2006, approximately 980 people were employed on the Heyford Park site and there were 315 occupied dwellings. As development of the site proceeds it is expected that the number of jobs will increase up to 1,458 and the total dwellings will number 1075. As these increases take place, demands placed on the transport infrastructure will intensify and impacts will be higher than at present or during the early stages of development. It is important, however, at this stage, to set up the framework needed to begin the process of developing a full and comprehensive travel plan.

This chapter of the Transport Assessment sets out the structure that needs to be established for a travel plan and the key people and organisations that need to be involved. While it may be premature to implement some measures that a full-scale travel plan may contain until there is a clearer understanding, gained through residents and employee travel surveys, of the transport patterns generated by the development, there are many measures that can be initiated earlier in the process. Section 16.9 below describes a toolkit of travel plan measures, many of which can be implemented in the short term. However, this chapter should be seen as providing a framework for the travel plan rather than being too prescriptive about measures that the final travel plan will contain. The plan needs to be seen as an evolving, on-going process that is regularly reviewed and developed as travel patterns and demands at the site evolve.

16.2 Existing Travel Patterns

The existing residential dwellings and commercial operations at Heyford Park have been established for some years and therefore information is available regarding existing travel patterns.

Journey to Work data from the 2001 Census was obtained from the government's Office for National Statistics. This provided details of the origins of trips to employment facilities at Heyford Park and the workplace destinations of Heyford Park residents travelling away from the site. A large majority (88%) of all journeys to and from work at Heyford Park are made by car. The Census data revealed a wide geographic spread of different origins and destinations. Full details are contained in **Appendix B**.

Foot and cycle journeys amount to some 6% of all trips and the majority of these are internal trips within the Heyford Park settlement area. Approximately 4% of trips are by bus, nearly all to/from Bicester or Oxford. Trips by train totalled 1%, all of which were to either Oxford or London.

Taking into account the existing travel patterns, the availability of alternatives to car use and location of the site in terms of distances to towns and services, it must be concluded that private vehicles will continue to provide the major transport mode but that the travel plan should take all reasonable steps to encourage use of more sustainable modes.

16.3 Policy Background

The development of an outline travel plan to be submitted with the Transport Assessment conforms to guidance set out in 'Planning Policy Guidance PPG13'. More recently, the

Government published 'Making Residential Travel Plans Work: Good practice guidelines for new development' (2005). This sets out the role of travel plans thus: "a travel plan can be a key tool in resolving the transport issues highlighted by the transport assessment. The travel plan should include both the physical and management measures necessary to address the transport impacts arising from the new development, as it will become a key management tool integrating all the different elements. It should be developed as the last part of the transport assessment process but is separate from it. Once planning permission has been granted, the travel plan will provide the ongoing management tool for implementing the necessary transport measures to the site."

Locally, Oxfordshire County Council recognises the significant role travel plans can have in meeting Local Transport Plan objectives and has developed a Travel Plans Strategy which focuses on the development of school and workplace travel plans.

16.4 Travel Plan Management Structure

It is proposed that control and direction of the Heyford Park Travel Plan will be undertaken by North Oxfordshire Consortium. Representatives from Cherwell District Council, Oxfordshire County Council and the local Parish Council will be consulted regarding strategic travel plan issues. The travel plan will be managed for a period of seven years from occupation of the first new dwelling to be constructed, after which, responsibility for the travel plan will be discussed with Cherwell District Council and Oxfordshire County Council.

North Oxfordshire Consortium will:

- Manage progress of the Travel Plan and guide its strategic development as Heyford Park expands;
- Manage and support a Travel Plan Coordinator;
- Integrate the travel plan with other aspects of the site's operations and management; and
- Confirm targets and monitoring arrangements for the travel plan.

16.5 Travel Plan Coordinator

North Oxfordshire Consortium, the owner of the site and planning applicant, is a small employer and low generator of travel but as developer will take the lead role in establishing the framework necessary to maximise benefits from the travel plan through funding or taking the role of a Travel Plan Coordinator. It is proposed that the Coordinator be appointed prior to occupation of the first new dwelling and that North Oxfordshire Consortium will fund the post for a period of seven years, after which the future of the post will be discussed with Cherwell District Council and Oxfordshire County Council. It is expected that the Travel Plan Coordinator will play the crucial role in implementing the travel plan and therefore sufficient resources will be allocated to support this post.

The responsibilities and roles are likely to include:

- Developing and overseeing the implementation of initiatives outlined in the travel plan;
- Stimulating and maintaining commitment and support from employers on site;
- Promoting the use of public transport, car sharing, cycling and walking;
- Collecting and distributing information and acting as point of contact for employees, residents and visitors regarding the travel plan and travel issues;
- Liaising with the local Parish Council, Cherwell District Council and Oxfordshire County Council. The County Council has a Travel Plans Development Team to provide advice

and resources with which the Travel Plan Coordinator will liaise as the development progresses;

- Liaising with public transport operators, taxi firms, and cycle dealers to negotiate improved services and discounts for travel and purchase of cycles;
- Marketing and promoting the travel plan through meetings, production of posters, leaflets, newsletters, timetables etc;
- Liaising with other stakeholders of the travel plan, different employers within Heyford Park and other groups such as Trades Unions, Staff Associations, Residents Groups and Volunteer groups that operate within the site;
- Consulting with local external interest groups such as residents of surrounding villages, Pedestrians and Cyclists Groups, Public Transport User Groups etc; and
- Monitoring the effectiveness of the travel plan in meeting the needs of residents, employers and employees on the site and in reaching any targets.

16.6 Development of the Travel Plan

16.6.1 Liaison Group

It is recommended that the Travel Plan Coordinator sets up and administers a Liaison Group, operating within parameters set by North Oxfordshire Consortium, to drive the travel plan forward by encouraging and co-ordinating input from site users. The Liaison Group should be chaired by the Travel Plan Coordinator and comprise North Oxfordshire Consortium, residents groups, key employers and transport operators. Contact with the Liaison Group should be sought from all tenants and residents of the site and senior management representation from employers should be encouraged.

It is recommended that support for the travel plan be illustrated by commitment to regular meetings at approximately three monthly intervals.

16.6.2 Involvement of all occupiers of the site

The Heyford Park site currently houses a number of individual companies and organisations as well as 315 dwellings providing accommodation for some 800 people.

It will be essential to work closely with the largest employers on the site, but emphasis should also be given to encouraging 'buy in' from all present and future occupiers of the site in order to maximise benefits. Although influencing travel behaviour among the staff of the larger employers could have a large beneficial effect, it would be inappropriate to focus too much on travel demand deriving from the main employers to the neglect of demand generated elsewhere. Measures introduced as part of the travel plan will be most effective if applied universally across the site. For example, measures that encourage increased use of public transport are likely to become more sustainable as the number of new users increases and this is more likely to happen if travel plan measures are applied across the whole site.

Contact will be made with all organisations and residents housed on the site with a view to encouraging their involvement and applying the travel plan across the whole site.

16.6.3 Residents and Employees

Census data reviewed during development of the Transport Assessment suggests that there is little difference in journey to work travel patterns between residents and people working at Heyford Park. The development of a travel plan should consider both residential and employee travel although initial emphasis should be placed on employees as this is more likely to yield some early results. There are several reasons for this. Firstly, the proportion of new commercial development compared to the proposed total is significantly lower than the proportion of new dwellings compared to proposed total number of dwellings. This

means that a large number of employees are already working at Heyford Park and can therefore benefit from the introduction of a travel plan whereas the majority of residents will not arrive until sometime in the future as the development proceeds. The second reason is due to the availability of data concerning existing travel patterns; this should be easier to collect from employees via a questionnaire survey although commitment is required from each employer and there will be a role for the management company, as landlord, in encouraging employers to participate. Finally, employers will have better access to members of staff for distributing information and advice about travel issues and encouraging more sustainable choices.

Travel information, timetables, and advice however, should still be distributed to existing residents and most travel plan measures will be of benefit to all users of the site. In future years as the development proceeds and the number of residents increases, equal emphasis should be given to employee and residents' travel issues.

16.6.3.1 Residents and Employees Working Groups

An important element in a successful travel plan is the involvement and commitment of individuals. It is suggested that two working groups be established in order to encourage residents' and employees' interest in the plan and give a sense of ownership. Meetings should be organised and chaired by the Travel Plan Coordinator.

The Residents Working Group should be comprised of interested individuals who are willing to invest time to participate and encourage other residents to support and actively promote the measures in the travel plan.

Where possible, the Employees Working Group should include representatives from all areas of the organisations involved and all grades and levels of seniority. It is advisable, initially, to invite expressions of interest from everyone in the organisation in order to make all staff members feel involved and gain a good cross-section of group members. Attendance by employees should be voluntary but it is important that company managers reflect the importance of travel issues by allowing staff to attend working group meetings.

The purpose of the working groups is to allow individuals to have an input into the travel plan's objectives, initiatives and measures. Discussion of the travel issues should be facilitated and people encouraged to express their ideas as individuals can help to identify barriers to walking, cycling or the use of public transport as well as suggest possible solutions. A secondary function of the working groups is to keep residents and employees informed of the travel plan's development and encourage a high profile for the plan, its initiatives and objectives.

16.6.3.2 Mode Groups

Residents and employees who travel by the same mode and therefore share common experiences should be encouraged to join mode groups, which would be set up and run by the Travel Plan Coordinator. Suggested mode groups might include a Cyclists Group, Bus Users Group, Pedestrians Group and Car Sharers Group. Within regular meetings group members may be encouraged to discuss travel plan issues from their modal viewpoint, suggest measures that may help increase use of the mode, share ideas and help encourage others to use the mode.

16.7 Objectives, Targets and Monitoring

It is proposed that travel plan objectives, targets and indicators will be formulated by North Oxfordshire Consortium. They should take account of any guidelines provided by Oxfordshire County Council and Cherwell District Council and may be informed by examples of good practice achieved at similar developments.

The overall, strategic aims of the travel plan need to be expressed as the plan's objectives. These will provide the long-term focus for what the plan is attempting to achieve. Objectives

can be quite broad and to an extent, aspirational. For example, an objective might be to 'reduce unnecessary single occupancy car trips to Heyford Park'. They need to be formulated taking account of the particular issues and problems that the travel plan are expected to tackle.

If viewed as a hierarchy the next level below the objectives are targets. These need to be quantifiable goals that can be used to measure progress towards achieving the plan's objectives. Targets need to be realistic yet challenging, and should also be considered carefully with regard to the desirability for the travel plan to be seen to be 'successful'. Unrealistically high targets will inevitably prove to be unachievable with a consequent reduction in credibility of the plan and possible de-motivation of people trying to make it work. Conversely, low targets may be met easily and the scheme appears to be successful but in reality little travel reduction or modal shift achieved.

Once objectives and targets have been set it is usual that indicators are developed in order to see if targets have been met and progress made towards achieving the strategic objectives. The timescale for monitoring should be specified as part of the target and may be a single date, for example 'contact local bus companies by 1st October', or involve a regular assessment of an indicator, for example, 'the number of car-sharers registered on the 1st of each month'. An extremely useful monitoring tool is to repeat a Travel Survey at regular intervals, ideally annually. It is therefore useful to plan the survey and questionnaire structure with due regard to the plan objectives and targets.

16.8 Data Gathering Tools

A Travel Survey and Site Assessment should be carried out. These are both essential data gathering exercises, the purpose of which is to inform development of the travel plan. The survey also plays a secondary role in establishing a baseline against which the performance of the travel plan may be assessed. On completion of the survey and assessment the information gained should be used to identify the most suitable and potentially beneficial measures for inclusion in the travel plan. It is important to stress that for the plan to be successful, effort should be focussed on those measures that the survey suggests have the biggest potential to influence travel patterns. A 'spread shot' approach of introducing a variety of measures is likely to be less effective than targeting those groups and individuals whom the survey indicates are willing to change, given the right support.

As the development proceeds, travel patterns will evolve and will continue to do so into the foreseeable future. It is therefore suggested that a travel survey and site assessment is carried out in order to facilitate the initial development of the travel plan and that further surveys are instituted and the travel plan adjusted, as the development grows.

16.8.1 Travel Survey

This is an essential part of a travel plan in that it records travel patterns and therefore allows the most suitable and potentially effective measures to be developed in the plan. There are a number of key data that the survey should aim to collect from each resident and employee:

- Heyford Park resident or employee;
- Home location;
- Work location;
- Usual mode used for the journey to work;
- Normal working hours; and
- Assessment of measures that would encourage use of alternatives to single occupancy car use.

These issues should be explored in detail in order to gain a useful understanding of travel patterns and the underlying factors that cause people to use the modes that they do and what the barriers are to modal change.

16.8.2 Site Assessment

A site assessment should be carried out in order to complement information gained from the travel survey. The assessment is, in essence, an audit of the current situation regarding such elements as walking and cycling routes and other facilities, public transport services, car parking availability and the availability of nearby shops or other services that may influence travel patterns. Much of this material will be available from the Transport Assessment. On completion of the assessment it should be possible to identify:

- Factors that are acting as barriers to non-car use;
- The existing alternatives that are available; and
- Improvements that could help to encourage alternative modes.

16.9 Travel Plan Measures

Without wishing to pre-empt the findings of the initial travel survey and site assessment, and the strategies and measures formulated by North Oxfordshire Consortium, experience from similar sites suggests the following package of measures should be considered for use and implemented as appropriate.

16.9.1 Information

Travel plan notice boards should be erected at strategic locations in Heyford Park. These would provide information about the travel plan and travel issues, display public transport timetables, newsletters, car share scheme details, etc.

A Travel Information Pack should be developed and distributed to all existing and new residents and employees. The pack should encourage sustainable travel through identifying the potential health, financial and environmental benefits. It would contain information about the travel plan and ways in which individuals can help achieve its objectives. The pack should also include local walking and cycling maps, public transport guides, maps and timetables, car share information, taxi firm details, etc.

Employers should be encouraged to provide travel information and highlight travel issues within the induction briefings and material given to new staff. Travel information could be presented on company intranet sites and staff PCs could be linked to other travel sites such as Traveline South East which contains timetables for all bus services in Oxfordshire and a journey planner. Staff should be encouraged to take part in travel plan awareness events such as 'Travelwise Week'.

16.9.2 Infrastructure Measures

The masterplan for Heyford Park makes provision for new infrastructure and improvements designed to facilitate and encourage sustainable travel.

To the south of Camp Road, the new distributor road through the settlement will be appropriate for use as a bus route. Bus stops will be provided at intervals of approximately 350m.

Most dwellings in the settlement will have a bus stop within 400m walking distance.

The developer will construct a network of new footways and cycleways within the site and will upgrade existing footways within the Heyford Park development. Lighting of roads, footways and cycleways will be to the latest design standards.

Details of new and improved infrastructure are shown on the Built Form Masterplan.

16.9.3 Public Transport

It is proposed that North Oxfordshire Consortium will provide financial support for a period of seven years from occupation of the first new dwelling to be constructed, in order to allow the hourly frequency of the existing bus services to Oxford and Bicester to be increased to a half-hourly service.

The Travel Plan Coordinator will set up and administer a 'bus buddy' scheme that links staff or residents making similar journeys and employers will be encouraged to provide staff loans for season tickets.

16.9.4 Travel to School

A new primary school is proposed within the Heyford Park development. A green travel statement will normally be prepared for the school development and this should form the basis for a school travel plan. The proposals for the Heyford Park village centre includes a proposed 'drop-off' area in front of the school and a separate pedestrian and cycle access with a direct link to the off-road pedestrian and cycle route which runs through the centre of the neighbourhood.

Under the recent Education Act, all schools are now required to develop a travel plan and to submit information about the actual and preferred modes of transport as part of the annual school survey for the Department for Children, Schools and Families (DFCS) (formerly Department for Education and Skills). It is also an Oxfordshire County Council Local Transport Plan target that schools should develop and implement travel plans.

The school travel plan should consist of:

- Pupil existing mode of travel survey;
- Pupil preferred mode of travel survey;
- Provision of capital measures such as cycle parking and lockers;
- Development of 'walking buses' and 'cycling trains'; and
- Provision of public transport information where applicable.

There are no plans for a secondary school on site at Heyford Park. The existing bus services are timed to allow travel to school in Bicester. If sufficient new pupils require the services, provision will be made within the framework of North Oxfordshire Consortium's support for improved bus services, to increase the number of vehicles providing these school services.

16.9.5 Walking and Cycling

The potential for travel to and from Heyford Park on foot or by cycle is limited due to the location of the settlement; most destinations are too distant for all except the most committed pedestrians or cyclists. However, the travel data analysed in the Transport Assessment shows that there are a significant number of trips within the Heyford Park site. It is likely to be more effective to encourage use of walking and cycling for these internal trips.

Employers might be helped to encourage their staff by providing:

- Lockers and showers;
- Secure cycle parking;
- Financial incentives such as loans for cycle and equipment purchases; and
- Pedestrian entrances and shortcuts.

16.9.6 Travel Demand Reduction Measures

A shop, community facilities and primary school are proposed within the new Heyford Park settlement. Any other new facilities that can be encouraged, such as convenience stores, sandwich shop/coffee bar, and particularly cash dispensers, can reduce the need to travel off-site.

Further measures that could be promoted by the Travel Plan Coordinator include:

- internet shopping and communication via email;
- Heyford Park community web site;
- home working (where practical); and
- education to encourage culture change.

16.9.7 Business Travel

Support should be given to employers to review business travel arrangements:

- Pool car schemes reduce the need for employees to have their own car available;
- Business travel policies and payments should discourage travel, particularly by private car; and
- Business' fleet and lease vehicles types, fuel type and operating arrangements should all be as 'green' as possible.

16.9.8 Car Sharing

It is proposed that the feasibility of a car sharing scheme is investigated by the Travel Plan Coordinator. In essence, such a scheme links together people who make similar journeys in order to give them the option of sharing. Sharing the car with one or more other drivers means that each benefits from reduced individual mileage (which may mean lower insurance premiums) and reduced wear and tear on vehicles and therefore lower maintenance costs. Car sharing can be more sociable than driving alone and offers better personal security than returning to a parked vehicle alone.

Typically, people are encouraged to the car sharing scheme which utilises a software package to identify individuals who might be able to share their journeys. People can be matched by home postcode; work postcode; usual travel times; any regular diversion that a car sharer makes (eg. dropping children at school); non-smoker or smoker preference; male or female preference.

Drivers can either agree to share with other drivers and take it in turns to drive, or all use the same car each day and pay the driver towards the costs. The charge must not be more than the running costs plus any parking payment.

Individuals do not need to have a car. Non-car owners can share with a driver and it may be cheaper and more convenient than the bus for example. Car sharing is arranged to suit individual's lifestyles. Most people have pretty regular commitments or habits, e.g. childcare arrangements, sports fixtures and so on, which are incorporated as necessary.

Car sharing works in many different ways. Some people live close to each other, some drive to the car share house, park their own vehicle and travel onwards in a car share; some people pick up passengers at an agreed point en-route.

Car share drivers should inform their insurance company but it will not normally affect the costs although the insurance may become invalid if passengers are charged more than the running costs (there is normally a clause about driving for 'hire or reward').

Most car share schemes 'guaranteed ride home' by taxi or public transport in the event of an emergency or requirement to work late.

16.9.9 Car Club

Membership of a car club allows people access to a fleet of cars pre-parked in their neighbourhood. Car clubs are growing in popularity and their operation is increasingly sophisticated and can be tailored to meet the particular needs of individual members.

Early discussions with representatives of the leading car club; WhizzGo and CarPlus, a charitable organisation providing guidance for various stakeholders interested in car clubs, highlighted several factors as being of critical importance to ensuring the successful future performance of a scheme. Although a number of preconditions are met by the proposed Heyford Park development, some key requirements are lacking and therefore resources would be more effectively deployed if directed towards other elements of the travel plan. It is proposed, however, that the Travel Plan Coordinator will periodically review the appropriateness of reconsidering a car club scheme.

17 Construction Issues

17.1 Outline Planning Application

The Heyford Park masterplan proposals would be implemented in phases; although details of the phases, including phasing duration and the amount of construction traffic, are not available at this stage. It is therefore not possible to predict the precise impact of construction on the transport infrastructure. However, the following section sets out a number of principles and degree of detail that is appropriate to the outline planning application. At the appropriate time, a Code of Construction Practice will be produced for the site which will integrate many of the measures outlined below.

17.2 Construction Traffic Routes

Options for construction traffic to access the site are limited. The preferred route for construction traffic approaching the site will be from the M40 motorway and via the B430 to Chilgrove Drive/Camp Road.

17.3 On-Site Traffic and Pedestrian Movement

Traffic within the development will be subject to strict speed limits and will be restricted to designated and specific routes. Pedestrians will be strictly segregated from vehicles. Specific materials storage areas will be identified and managed as the interface locations between the bulk deliveries and the on-site distribution by forklifts, cranes and hoists.

Access times for construction traffic will be controlled with emphasis being given to movements outside of the peak periods but not during the night.

Dedicated circulation routes for site spoil movement will be set up and segregated where possible from the material delivery route. For large pre-planned loads or abnormal loads, local authority and police guidelines will be complied with and designated routes will be followed.

All vehicles will enter the site via security-manned posts/gates and drivers will be briefed by the traffic supervisor and issued with a copy of the site rules and route maps indicating storage areas, routes, speed restrictions etc. Vehicle arrival and departure times will be recorded. Regular co-ordination meetings will be organised in order to ensure good housekeeping.

Site personnel access to the site will be via security-manned posts/gates and segregated from on-site construction traffic, by means of vehicular barriers/fencing/hoardings etc.

17.4 Site Earthworks and Remediation

Excavated material will be re-used as much as possible. This will minimise the number of off-site vehicle movements and minimise the volume of material requiring off-site disposal at a licensed landfill. By maximising re-use of material on site, the volume of material to be brought to site will be reduced.

17.5 Construction and Demolition Waste

Opportunities will be investigated to maximise the recycling potential of demolition and construction materials. It is anticipated that any suitable materials will be crushed for possible reuse for backfilling and other purposes.

Initiatives to reduce waste streams include:

- reducing raw material waste through good design and utilising Modern Methods of Construction (MMC);
- maintaining a role in the management of the supply chain during construction;

- liaison with suppliers to enable packaging material to be sent back for reuse;
- engaging contractors in the process of maximising the use of recycled material;
- ensuring no vehicle leaves the site empty, i.e.; all return vehicles will take 'associated waste' off-site; and
- raw materials shall be stored in such a way as to reduce waste.

Only Environment Agency licensed waste hauliers, waste management contractors and landfill sites will be used to ensure compliance with legislative requirements. When leaving the site, vehicles will be sheeted/covered to prevent any escape of materials and washing facilities (including wheel wash) will be provided to ensure vehicles are clean when leaving the site and will not deposit matter onto the highway.

18 Appraisal of Impacts

18.1 Appraisal Summary Table

An outline NATA style multi-criteria assessment of transport impacts associated with the development has been carried out in accordance with Oxfordshire County Council's Transport Assessment Guidelines and is shown in Table 18.1.

Table 18.1: Appraisal of transport impacts

| CRITERIA | IMPACT |
|--|--|
| Environment | |
| <i>Noise levels caused by transport using the site</i> | It is considered that there will be no residual noise and vibration effects provided appropriate noise mitigation measures are put in place. |
| <i>Local air quality as affected by transport using the site</i> | The impact on air quality from transport associated with the development is negligible. |
| <i>Landscape, townscape heritage effects of transport using the site and the facilities made for transport use of the site</i> | For many years the site was a large military installation and many cold war heritage features remain. The transport and other elements of proposed development have been planned to form a coherent settlement with careful attention given to landscape and sustainability. |
| <i>Routeing agreements for HGVs</i> | The existing and proposed commercial operations at the site are likely to generate a number of daily HGV trips and therefore North Oxfordshire Consortium will enter into negotiation with Oxfordshire County Council with a view to concluding a routeing agreement. |
| <i>Rat running issues</i> | The site is located in a rural area with a choice of access routes, some of which pass through nearby villages. Public consultation events are proposed and mitigation measures will be considered if the issue of rat running in local villages is raised as a significant concern. |
| Safety | |
| <i>Risk of accidents for those using and passing by the site</i> | New roads on the site will be constructed to the latest design standards and traffic calming measures will be implemented. There is a single accident cluster on the B430 south of Ardley on the local road network with a higher than expected rate of occurrence. |

| | |
|--|---|
| | A cluster has also been identified at Junction 10 of the M40. |
| <i>Personal security of those using and passing by the site</i> | The site owner, North Oxfordshire Consortium, is not aware of any personal security concerns at the existing development. |
| Economy | |
| <i>Effects on the economic efficiency and vehicle operating costs of transport in the local area</i> | No quantitative analyses were undertaken. |
| Accessibility | |
| <i>Changes in access to transport systems</i> | Measures to improve local bus services have been suggested by Oxfordshire County Council and will be supported by North Oxfordshire Consortium. |
| <i>Accessibility changes in the local area</i> | The proposed development includes a shop, church, community hall and primary school thereby providing new facilities for existing residents in the area. |
| <i>Community severance (or linkages)</i> | The proposed layout of the development will divert commercial vehicles away from Camp Road, the main road through the settlement. Priority will be given to vehicle, cycle and pedestrian routes which link parts of the development rather than accommodating through traffic. |
| Integration | |
| <i>Links with other policy areas</i> | The scheme is consistent with the Local Transport Plan. |
| <i>Links between transport systems</i> | It is likely that measures to improve local bus services will include extending some services to Bicester North Station. |
| <i>Links with other land-uses</i> | This is a mixed use settlement that provides housing and employment opportunities on the same site. |

19 Summary and Conclusions

Arup was commissioned by North Oxfordshire Consortium to undertake a Transport Assessment in support of an outline planning application for the proposed development of Heyford Park, which forms part of the former RAF Upper Heyford in Oxfordshire.

The TA was prepared following discussions with the Highway Authority, Oxfordshire County Council and the Highways Agency in respect of the application and an understanding of the issues that need to be addressed arising from those discussions.

The Transport Assessment has been carried out based on the following elements:

- Residential - 1,075 dwellings
- B1 Office – 15,658sqm
- B2 Office - 17,996sqm
- B8 Storage – 86,113sqm
- Heritage Centre - 4195sqm
- Conference Centre – 4150sqm

Trip generation was derived from TRICS data and agreed with Oxfordshire County Council. It is estimated that for the opening year of 2013, the proposed development will generate 1763 and 1716 new trips in the AM and PM peaks respectively. Distribution was based on Census data related to the existing development.

Six junctions on the local highway network plus Junction 10 of the M40 (southern roundabout only) were assessed for capacity in 2013 with and without the full development. In addition, a 15 year after opening test (2028) was carried out for Junction 10. Of the six junctions on the local highway network, only one, the signalised cross roads of the B430 and B4030 at Middleton Stoney, did not operate within its theoretical capacity. However, proposed optimisation of the signal staging plus geometry alterations produced a sufficient improvement in junction performance to offset the impact of the development traffic in the opening year.

Test were also carried out which established that all of the proposed junctions that will provide access to the development perform within their theoretical capacity in the opening year.

The southern roundabout of Junction 10 of the M40 was tested and shown to perform just above its theoretical capacity in the opening year although by 2028 there is a significant deterioration in the performance of the junction. However, the impact of the development traffic can be negated by proposed changes to the carriageway markings.

An accident analyses was carried out and five locations with a slightly higher than average accident rate were identified for further investigation.

In order to mitigate the impact of traffic associated with the development on the road network a series of measures will be implemented by the developers:

- Enhancement of existing bus services;
- Implementation of HGV routing agreement;
- Minor improvements to Middleton Stoney crossroads and Junction 10
- Consideration of village traffic calming; and
- Implementation of a travel plan.

In conclusion, the Transport Assessment shows that the impact of the development is minimal and with the implementation of proposed mitigation measures there are no transport related reasons why outline planning permission should not be granted.

FIGURES

- Figure 1 Heyford Park and Local Road Network**
- Figure 2 Existing Accesses to Heyford Park**
- Figure 3 Highway Network Traffic Survey Locations**
- Figure 4 Camp Road Survey Locations**
- Figure 5 Existing Traffic Flows - Average Weekday AM**
- Figure 6 Existing Traffic Flows - Average Weekday PM**
- Figure 7 Traffic Flows - Average Weekday 2006 Base AM**
- Figure 8 Traffic Flows - Average Weekday 2006 Base PM**
- Figure 9 Traffic Flows - Average Weekday 2013 Base AM**
- Figure 10 Traffic Flows - Average Weekday 2013 Base PM**
- Figure 11 Traffic Flows - Average Weekday 2013 Base + Generated AM**
- Figure 12 Traffic Flows - Average Weekday 2013 Base + Generated PM**
- Figure 13 Junction 10 Traffic Flows - Average Weekday 2006 Base AM**
- Figure 14 Junction 10 Traffic Flows - Average Weekday 2006 Base PM**
- Figure 15 Junction 10 Traffic Flows - Average Weekday 2013 Base AM**
- Figure 16 Junction 10 Traffic Flows - Average Weekday 2013 Base PM**
- Figure 17 Junction 10 Traffic Flows - Average Weekday 2013 Base + Generated AM**
- Figure 18 Junction 10 Traffic Flows - Average Weekday 2013 Base + Generated PM**
- Figure 19 Junction 10 Traffic Flows - Average Weekday 2028 Base AM**
- Figure 20 Junction 10 Traffic Flows - Average Weekday 2028 Base PM**
- Figure 21 Junction 10 Traffic Flows - Average Weekday 2028 Base + Generated AM**
- Figure 22 Junction 10 Traffic Flows - Average Weekday 2028 Base + Generated PM**
- Figure 23 Agreed Junctions for Testing**
- Figure 24 Traffic Flows - Average Weekday 2013 Base + Generated AM SENSITIVITY**
- Figure 25 Traffic Flows - Average Weekday 2013 Base + Generated PM SENSITIVITY**
- Figure 26 Camp Road Accesses to Development 1: Dacey Drive**
- Figure 27 Camp Road Accesses to Development 2: Dow Street**
- Figure 28 Camp Road Accesses to Development 3: Main Gate**
- Figure 29 Camp Road Accesses to Development 4: HGV Access**

Figure 30 Camp Road Accesses to Development 5: Larsen Road

Figure 31 Personal Injury Accidents Location Plan

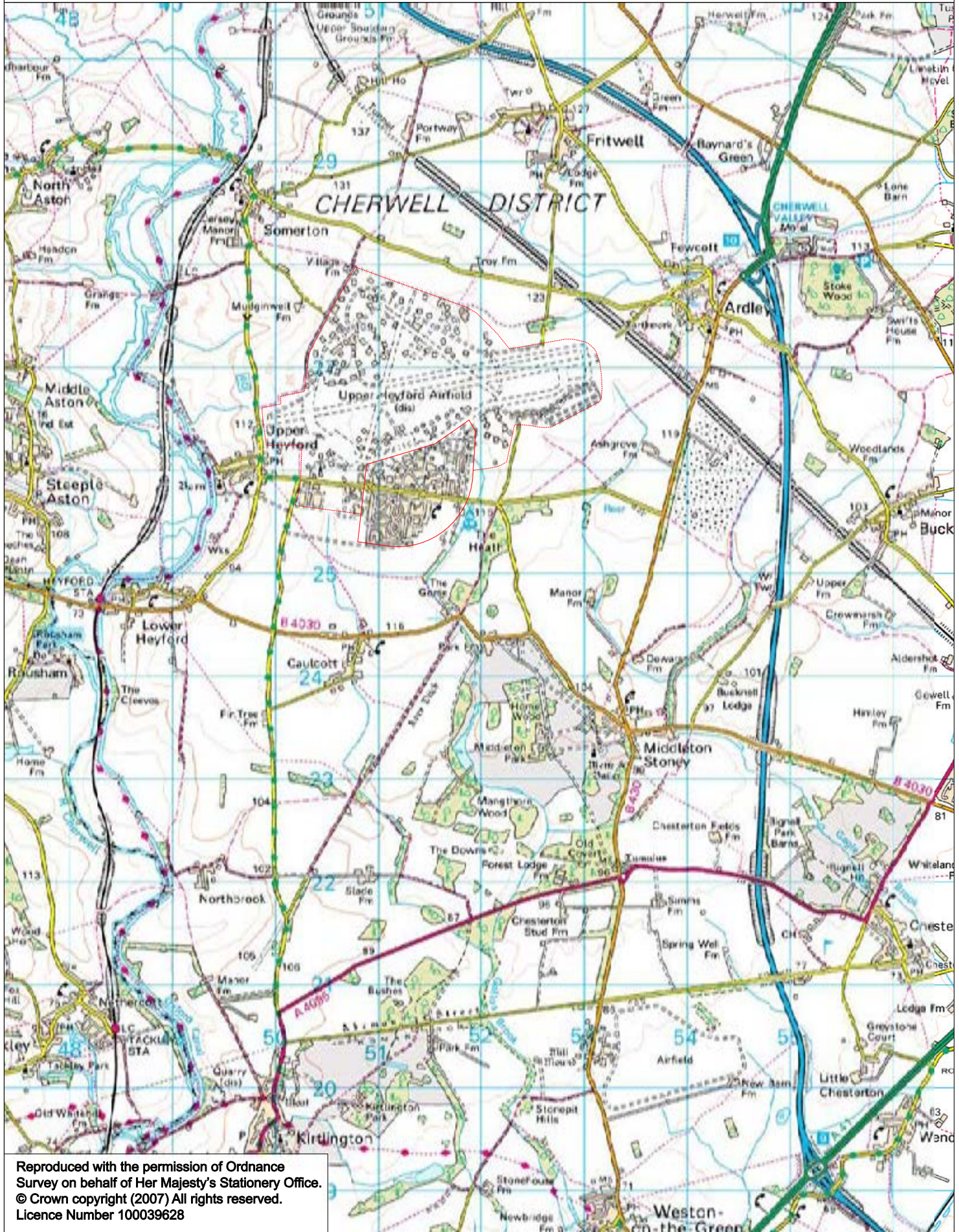
Figure 32 Bus Routes Serving Heyford Park

Figure 33 Heyford Park Accesses: Traffic Flows - Average Weekday 2013 Base + Generated AM

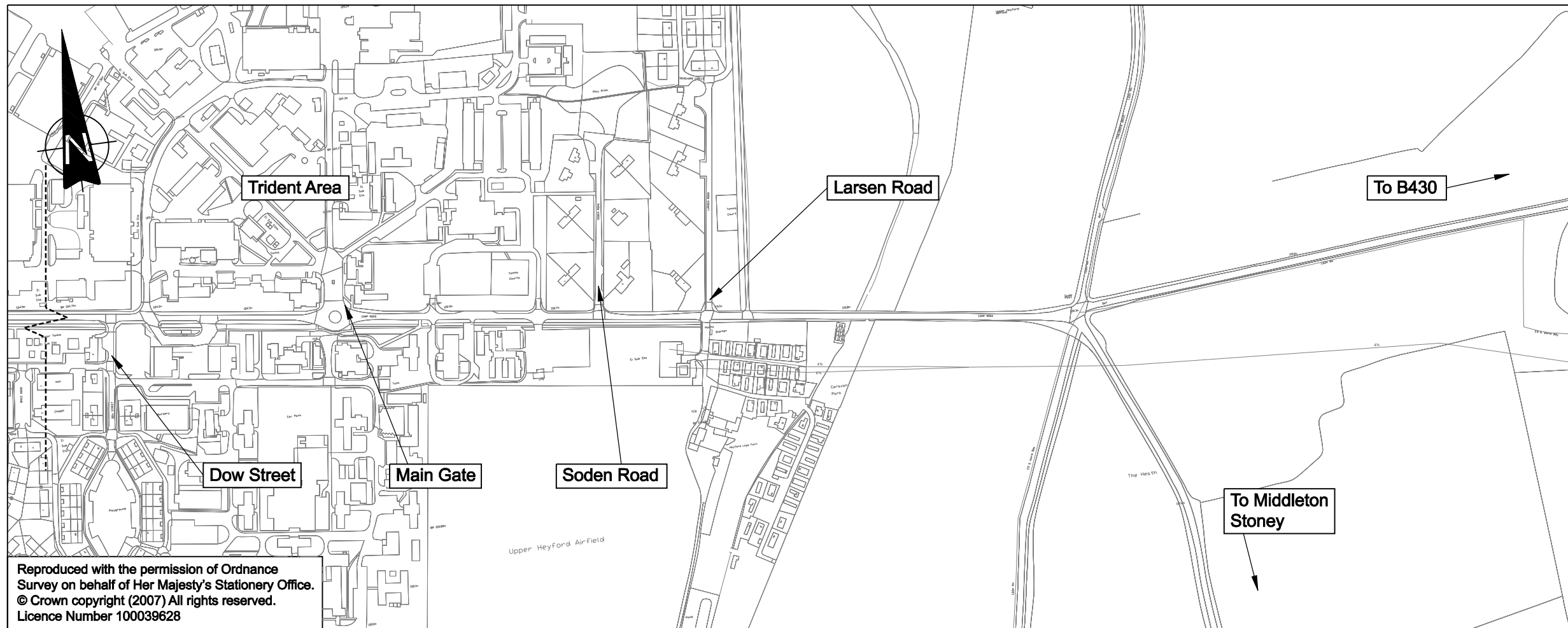
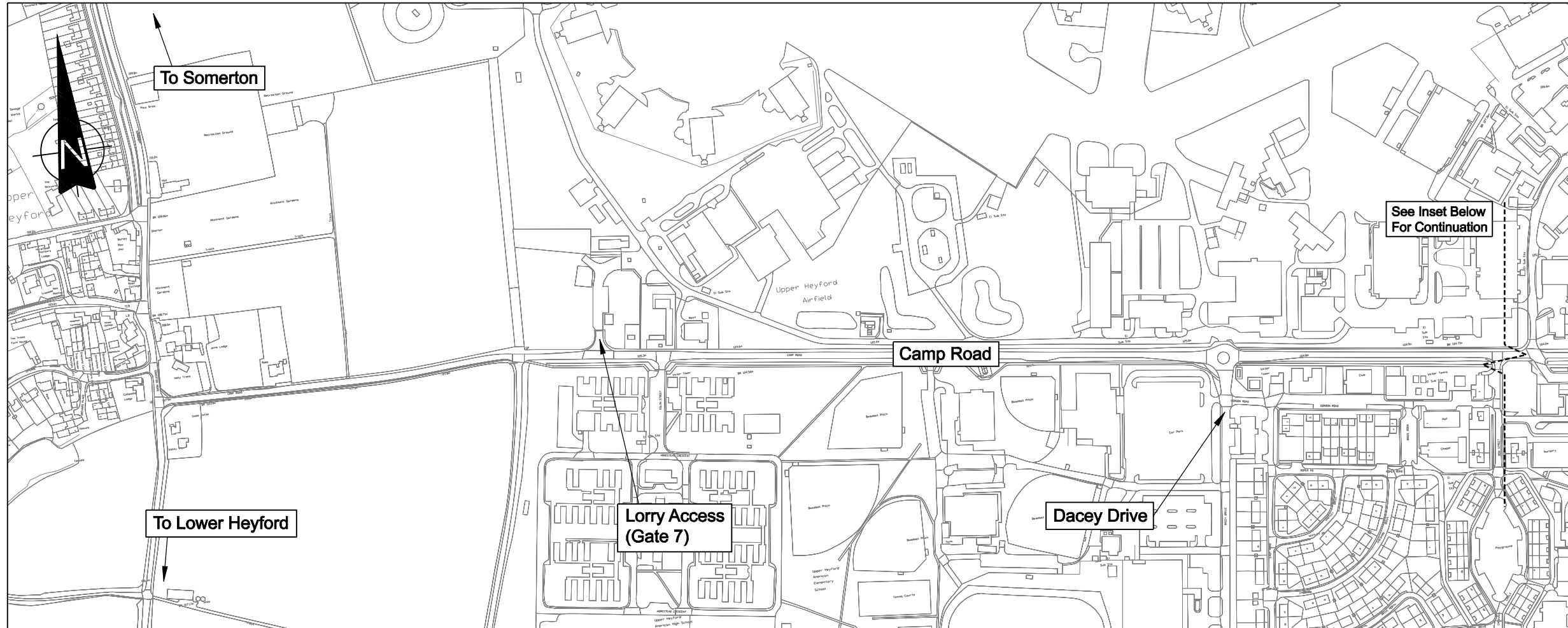
Figure 34 Heyford Park Accesses: Traffic Flows - Average Weekday 2013 Base + Generated AM

Figure 35 Proposed Alterations to Junction between B4030 and B430 at Middleton Stoney

Figure 36 Junction 10: Proposed Carriageway Marking Alterations



J:\120669\120669-00\Internal Project Data\4-03 Drawings\Figure_1.dgn



Reproduced with the permission of Ordnance Survey on behalf of Her Majesty's Stationery Office. © Crown copyright (2007) All rights reserved. Licence Number 100039628

| | | | | |
|-------------|----------|----|------|------|
| 01 | 06/02/07 | NS | IGC | IGC |
| First Issue | | | | |
| Issue | Date | By | Chkd | Appd |

ARUP

The Arup Campus, Blythe Gate, Blythe Valley Park
 Solihull, West Midlands B90 8AE
 Tel +44(0)121 213 3000 Fax +44(0)121 213 3001
 www.arup.com

Client
North Oxfordshire Consortium

Job Title
**Heyford Park
 Transport Assessment**

Drawing Title
**Existing Accesses to
 Heyford Park**

Scale at A3
1:5000

Plot ID

Drawing Status

Information

| | | |
|------------------|-----------------|-----------|
| Job No | Drawing No | Issue |
| 120669-00 | Figure 2 | 01 |



Keynote:

- Classified Turning Count Location
- Automated Traffic Count

| | | | | |
|-------------|----------|----|------|------|
| 01 | 06/02/07 | NS | IGC | IGC |
| First Issue | | | | |
| Issue | Date | By | Chkd | Appd |

ARUP

The Arup Campus, Blythe Gate, Blythe Valley Park
 Solihull, West Midlands B90 8AE
 Tel +44(0)121 213 3000 Fax +44(0)121 213 3001
 www.arup.com

Client
North Oxfordshire Consortium

Job Title
**Heyford Park
 Transport Assessment**

Drawing Title
**Highway Network
 Traffic Survey Locations**

Scale at A3
 1:50000

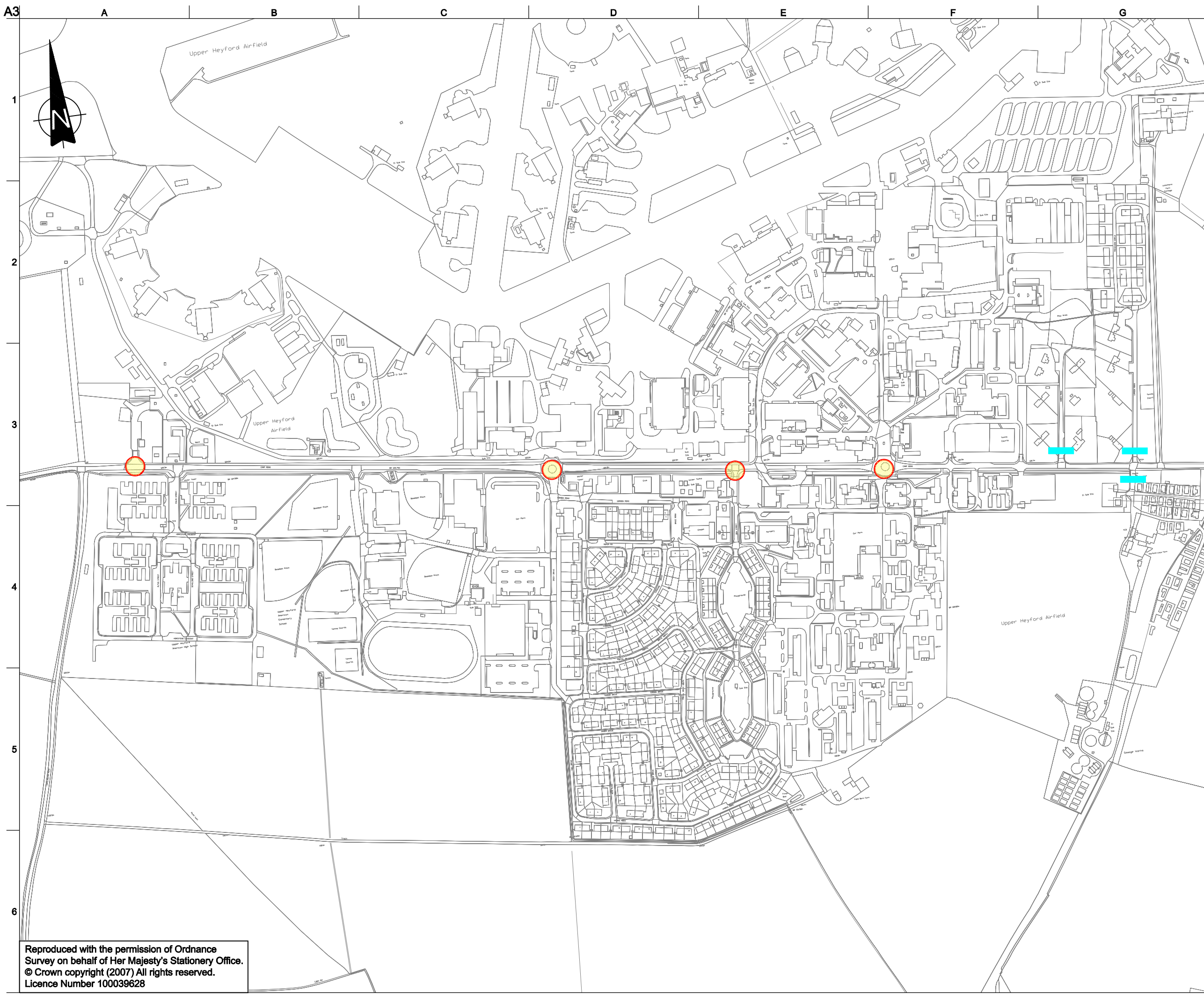
Plot ID



Drawing Status
Information

| | | |
|----------------------------|-------------------------------|--------------------|
| Job No 120669-00 | Drawing No Figure 3 | Issue 01 |
|----------------------------|-------------------------------|--------------------|

Reproduced with the permission of Ordnance Survey on behalf of Her Majesty's Stationery Office. © Crown copyright (2007) All rights reserved. Licence Number 100039628

J:\120000\120669-004 Internal Project Data\4-03 Drawings\Figure_3.dgn



- Keynote:**
-  Classified Turning Count Location
 -  Automated Traffic Count

| | | | | |
|-------------|----------|----|------|------|
| 01 | 06/02/07 | NS | IGC | IGC |
| First Issue | | | | |
| Issue | Date | By | Chkd | Appd |

ARUP

The Arup Campus, Blythe Gate, Blythe Valley Park
 Solihull, West Midlands B90 8AE
 Tel +44(0)121 213 3000 Fax +44(0)121 213 3001
 www.arup.com

Client
North Oxfordshire Consortium

Job Title
**Heyford Park
 Transport Assessment**

Drawing Title
**Camp Road
 Survey Locations**

Scale at A3
 1:5000

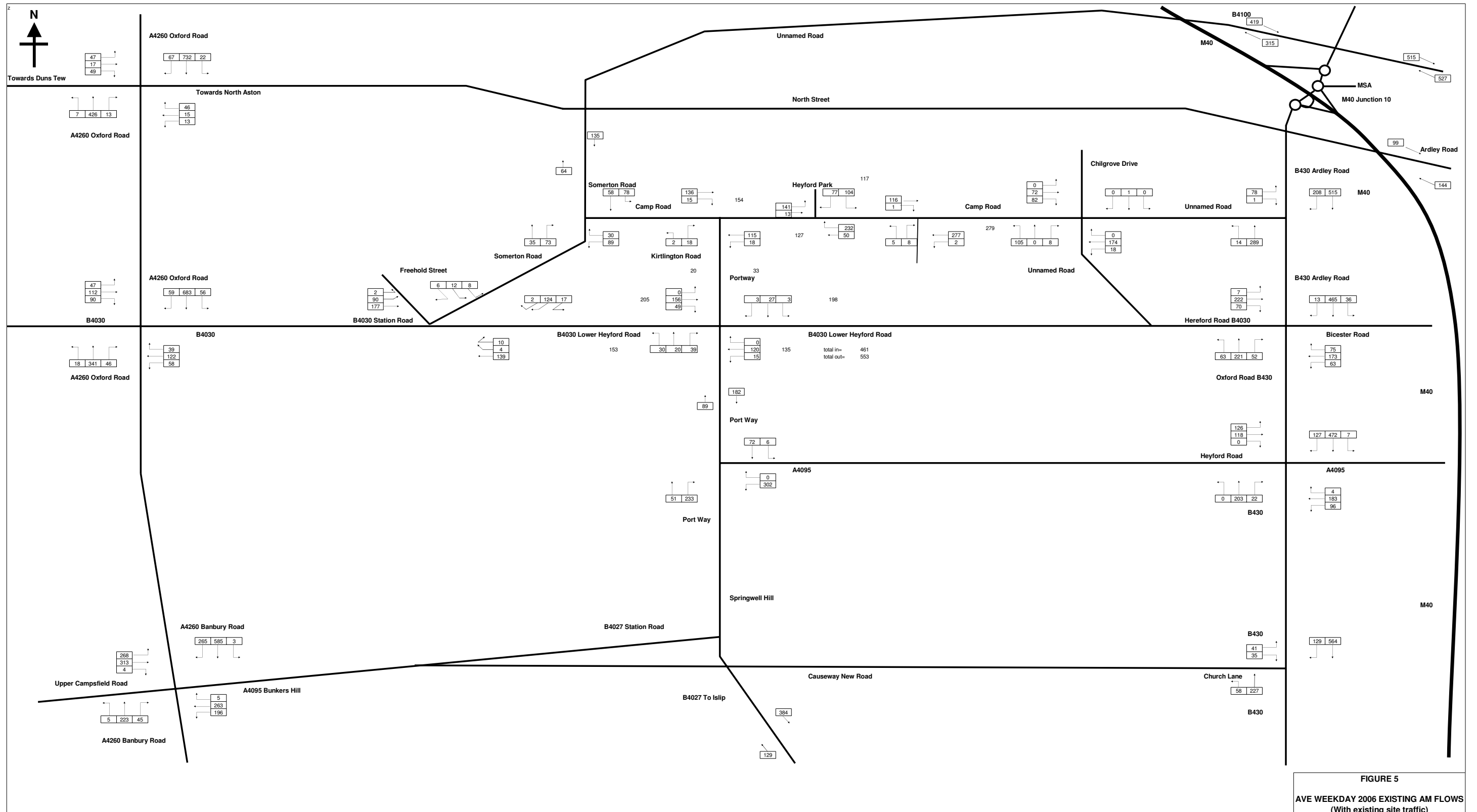
Plot ID

Drawing Status

Information

| | | |
|----------------------------|-------------------------------|--------------------|
| Job No 120669-00 | Drawing No Figure 4 | Issue 01 |
|----------------------------|-------------------------------|--------------------|

Reproduced with the permission of Ordnance Survey on behalf of Her Majesty's Stationery Office. © Crown copyright (2007) All rights reserved. Licence Number 100039628



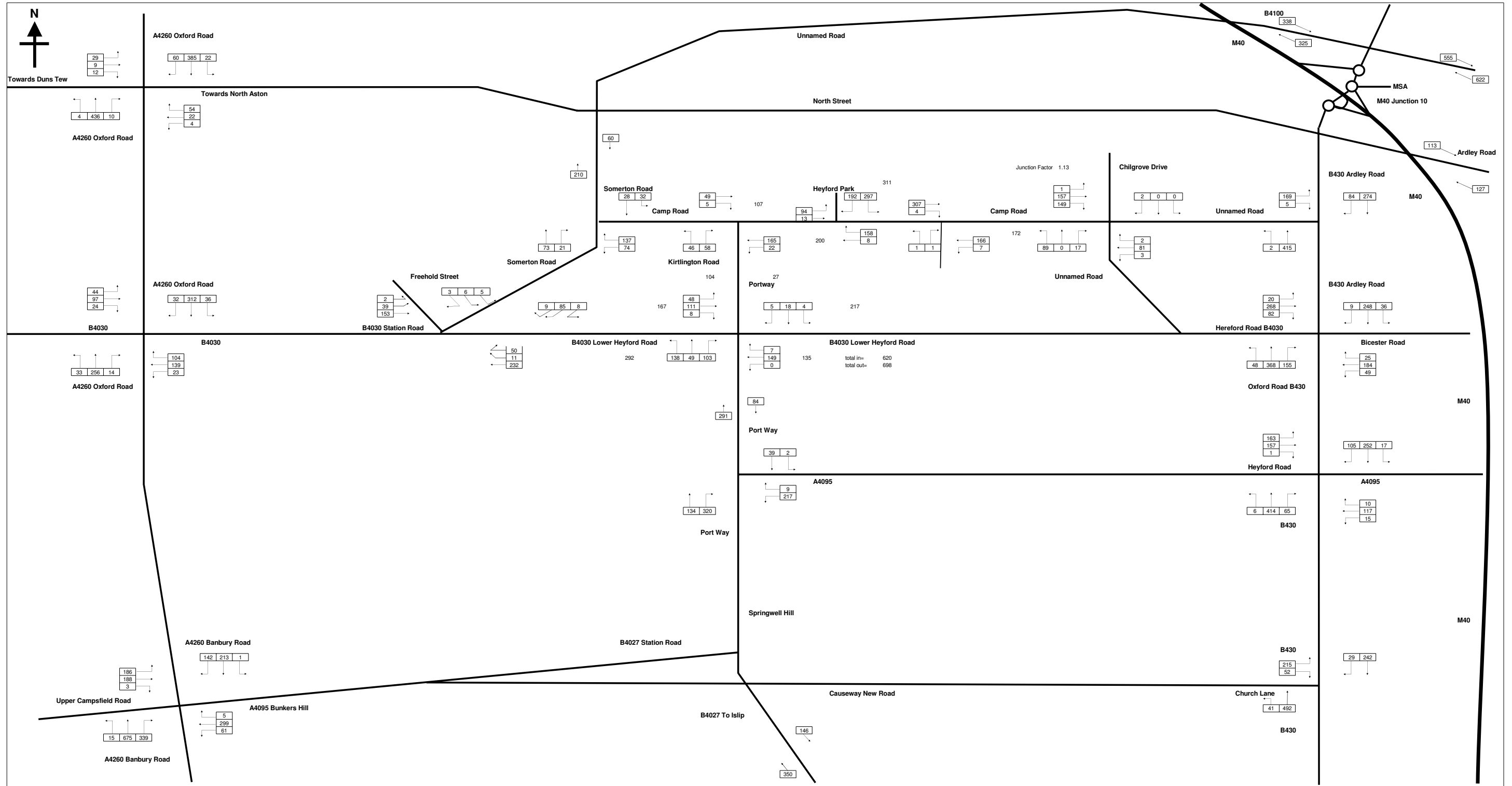


FIGURE 6
AVE WEEKDAY 2006 EXISTING PM FLOWS
 (With existing site traffic)

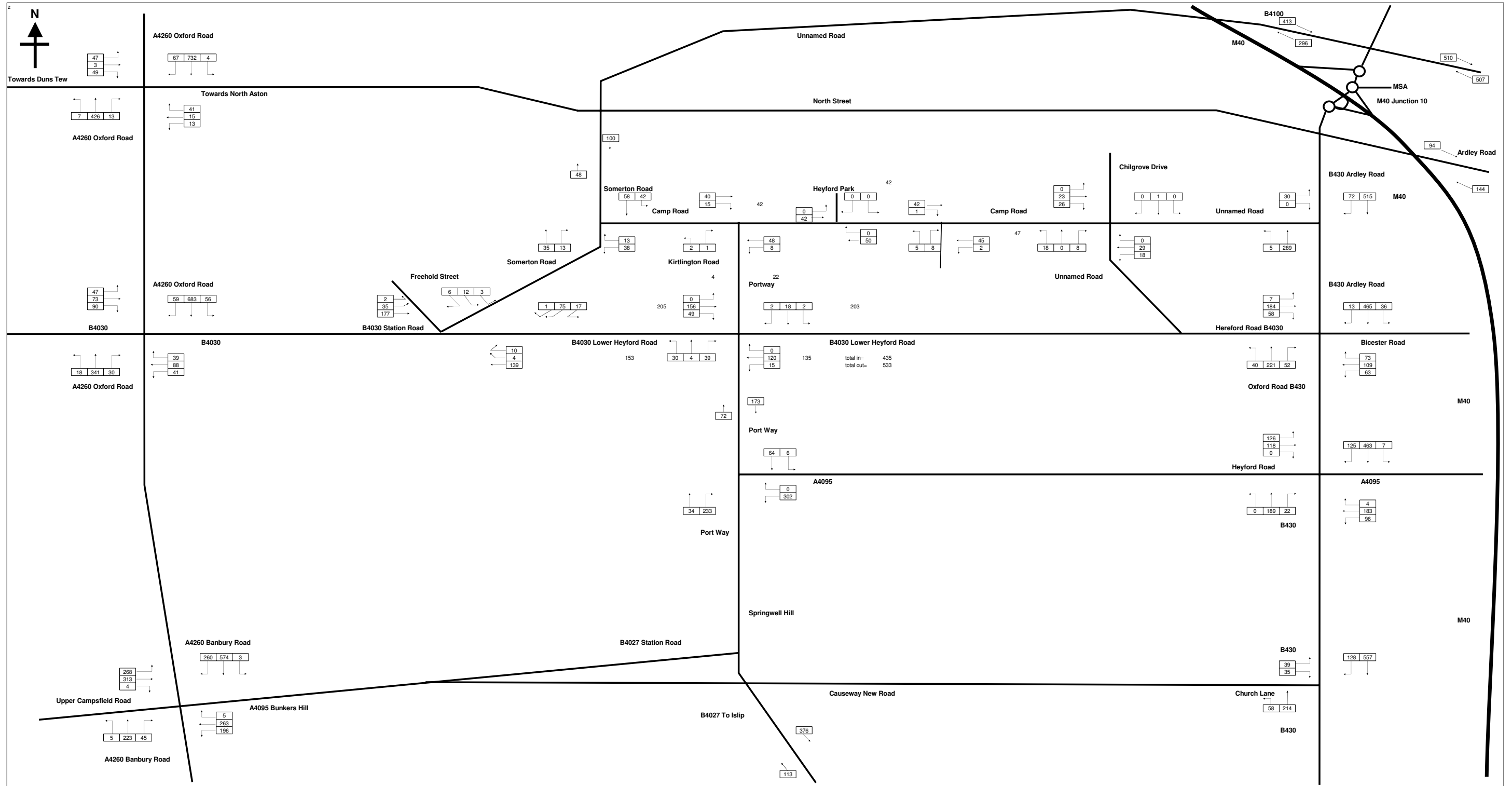
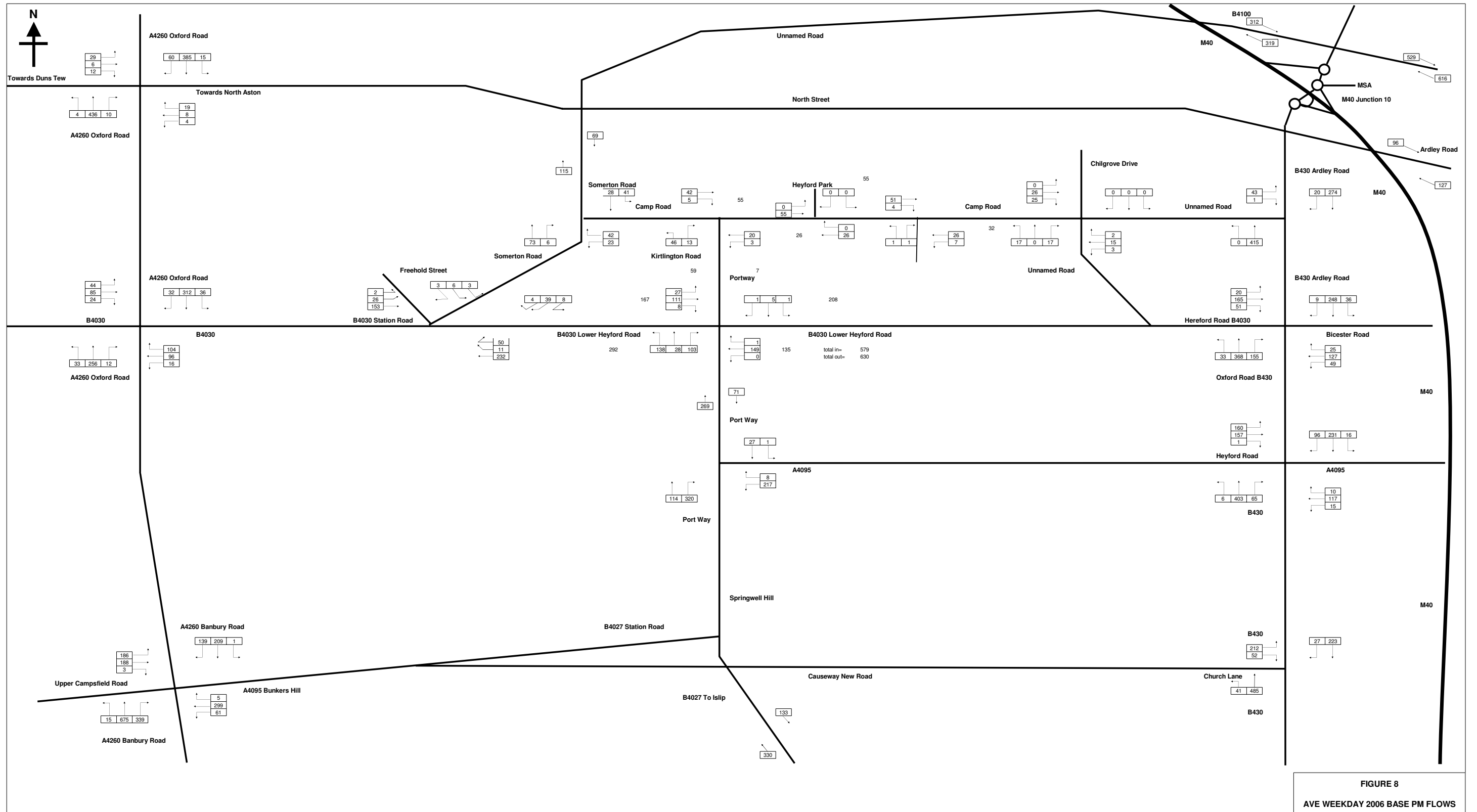
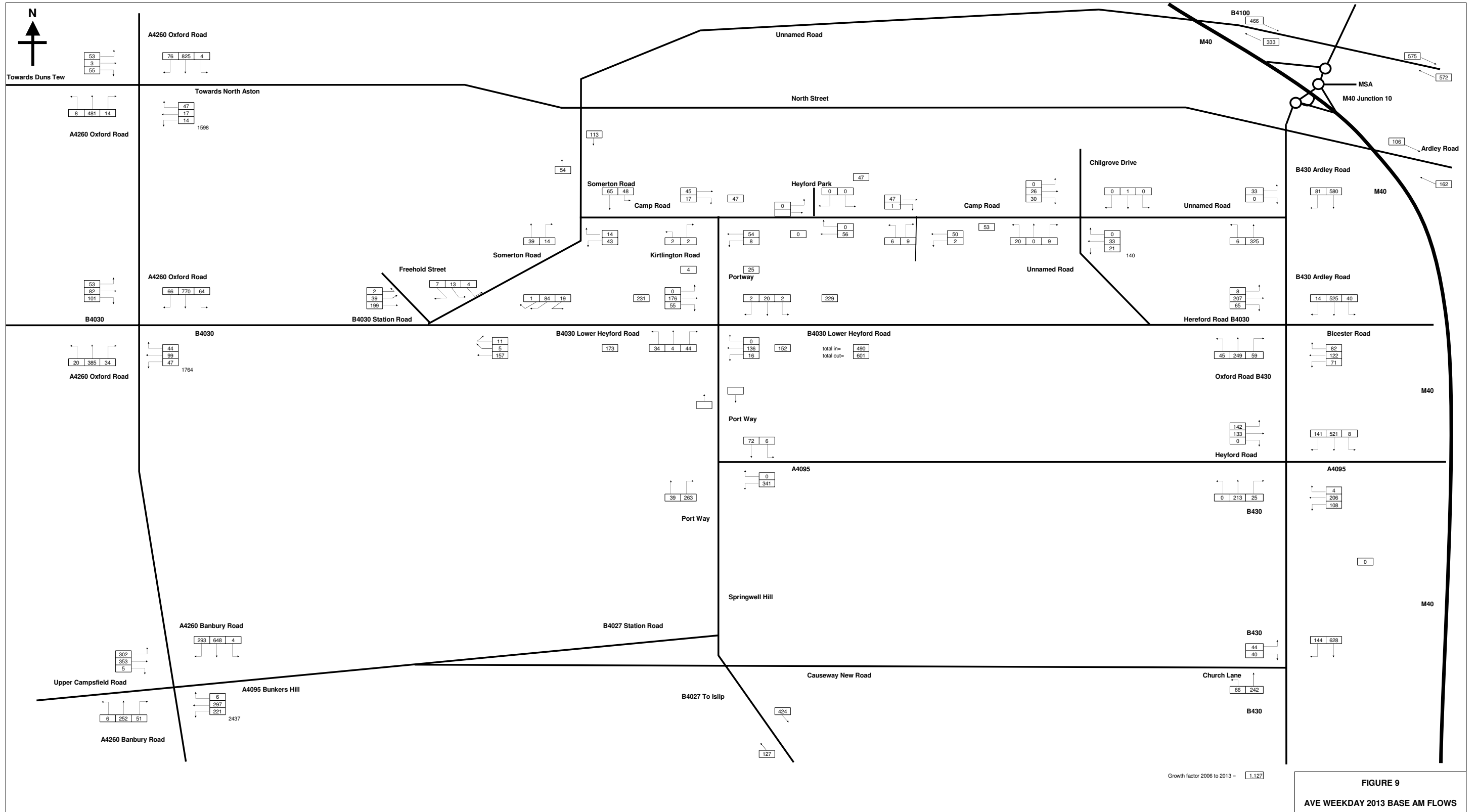


FIGURE 7
AVE WEEKDAY 2006 BASE AM FLOWS





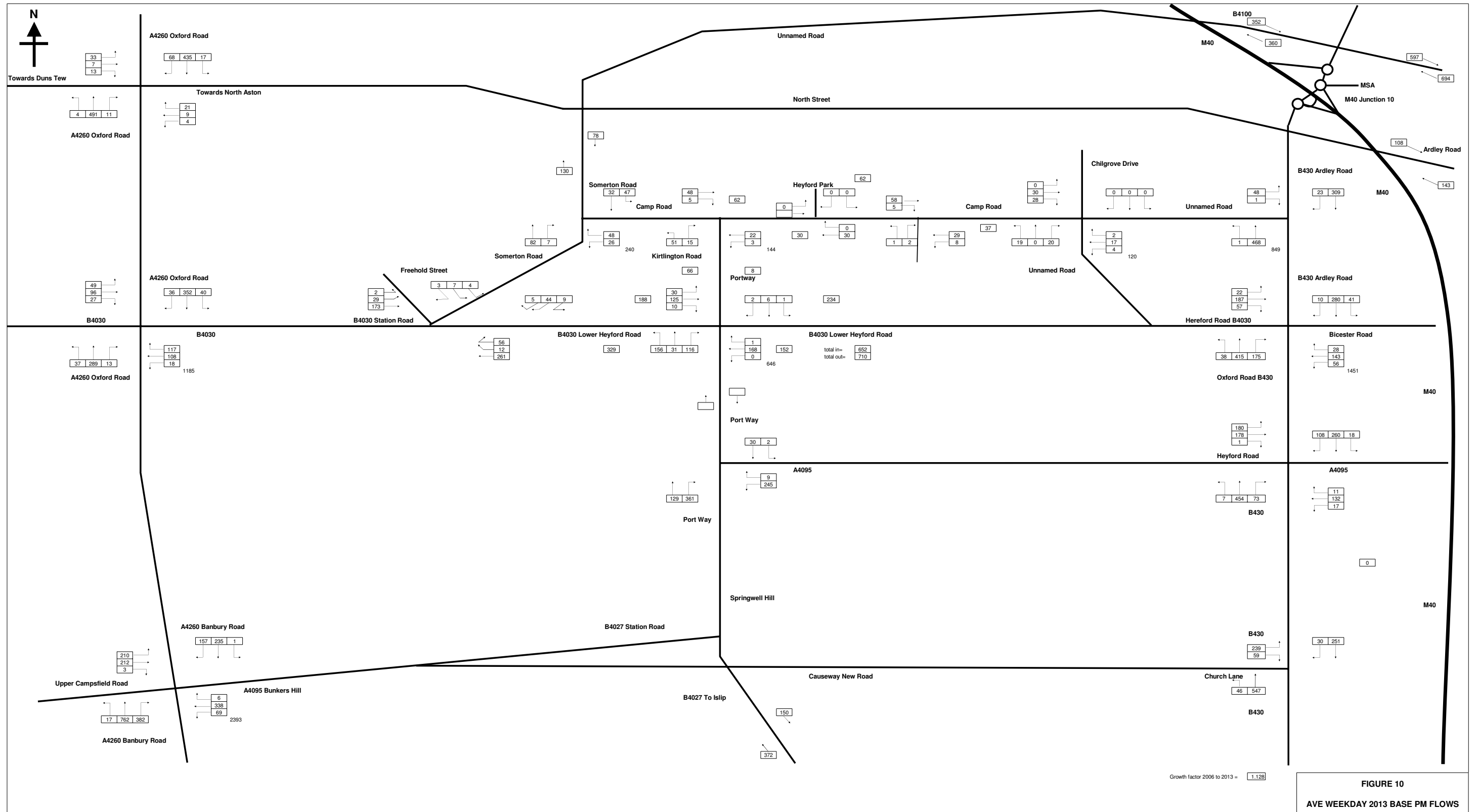
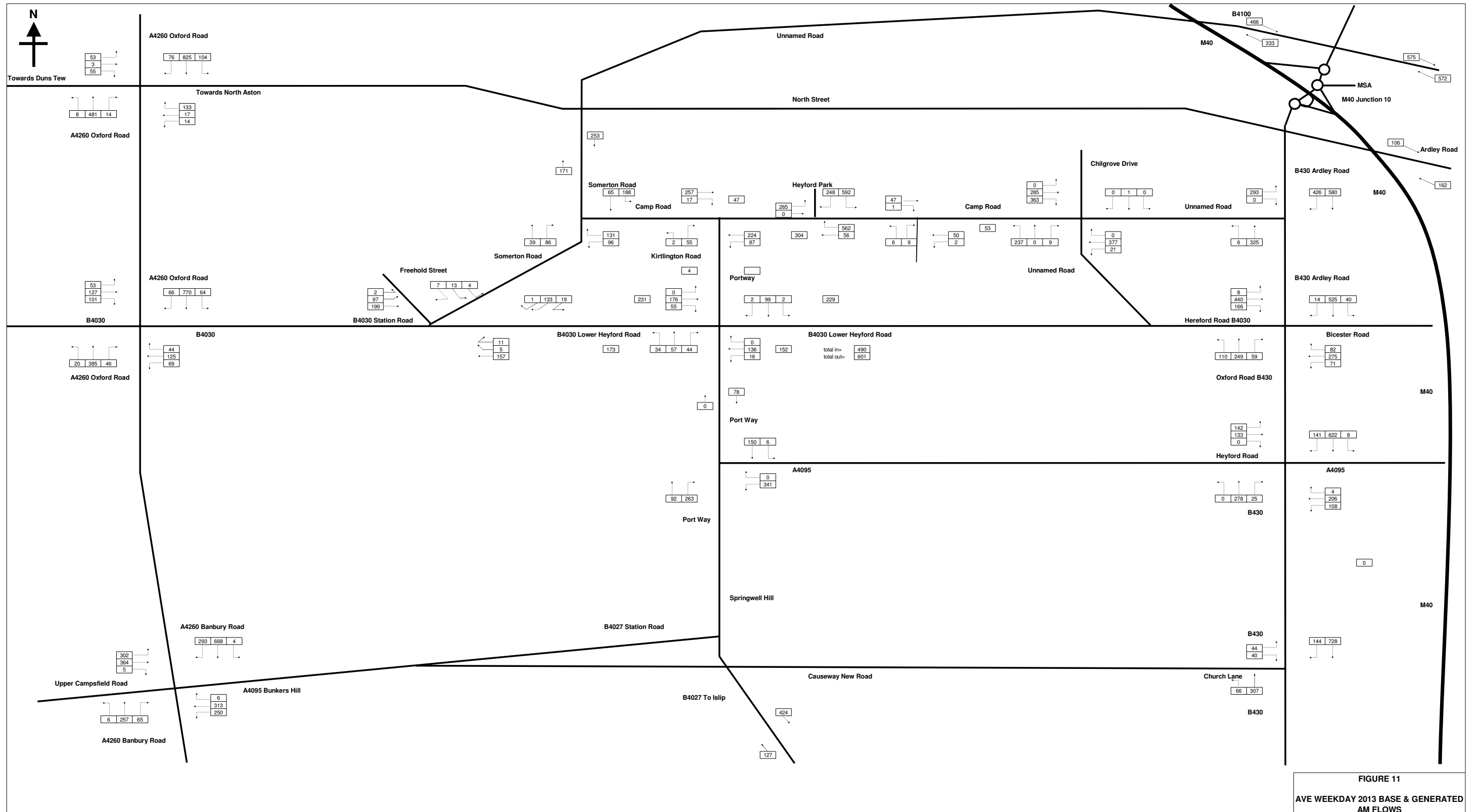
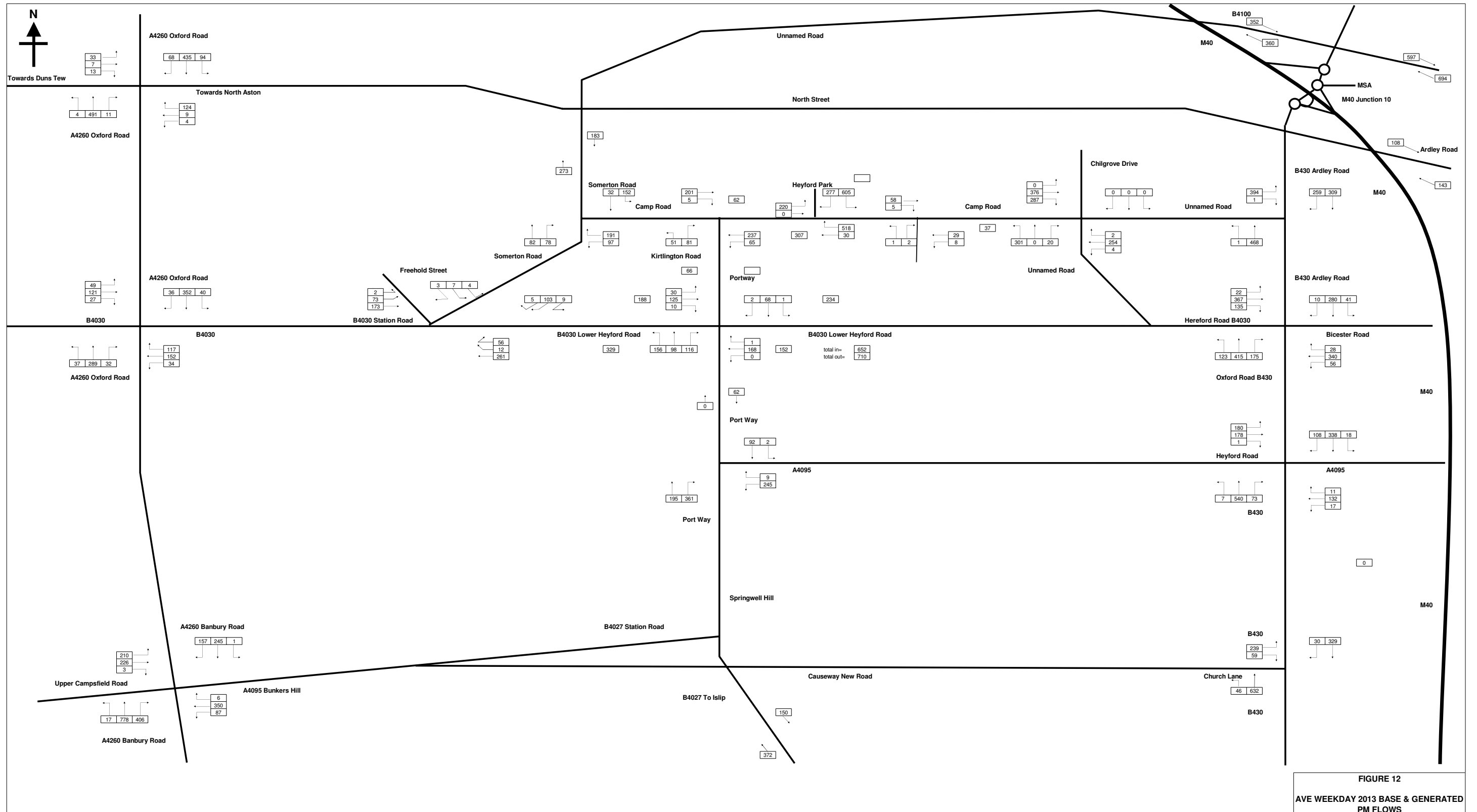
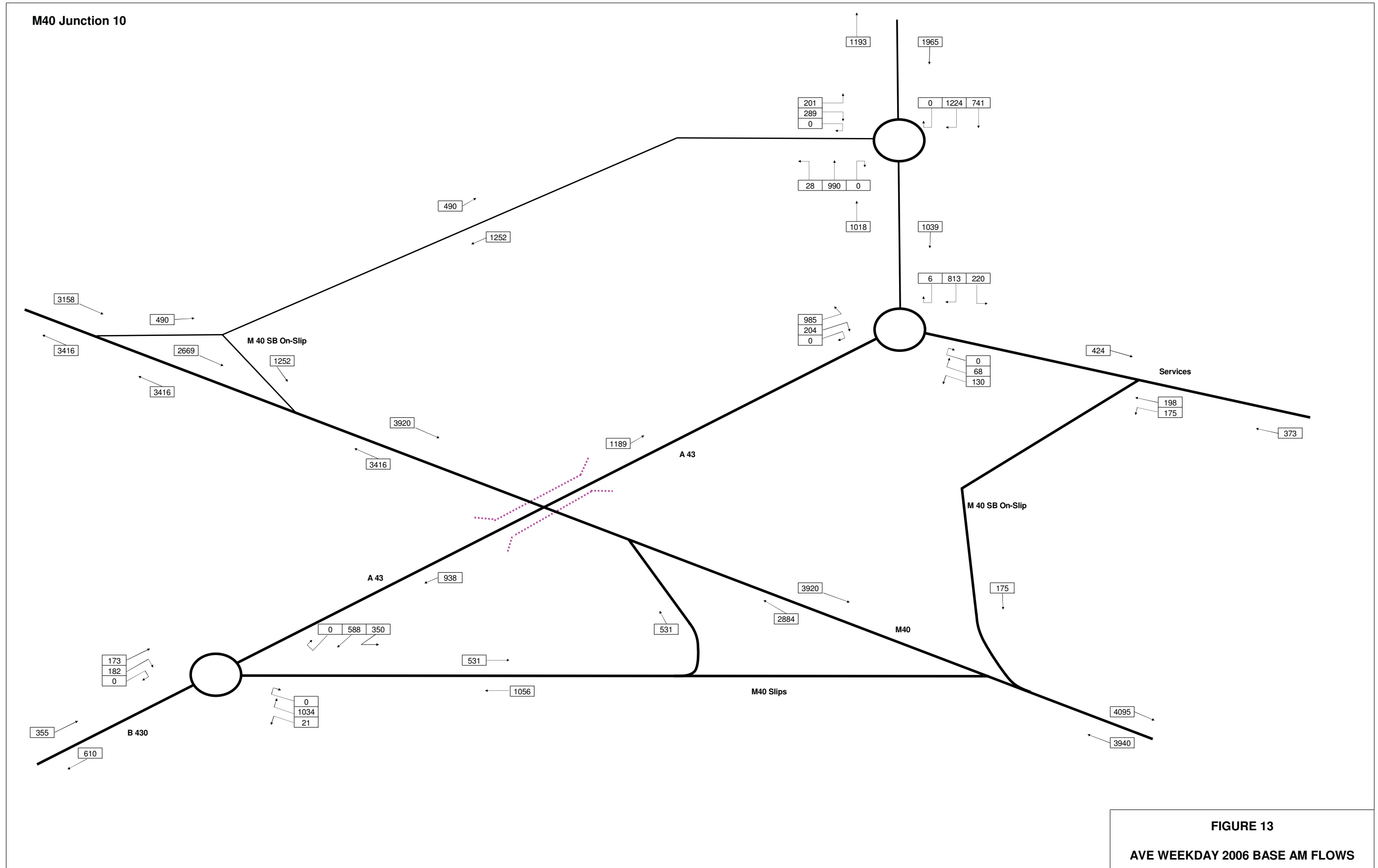
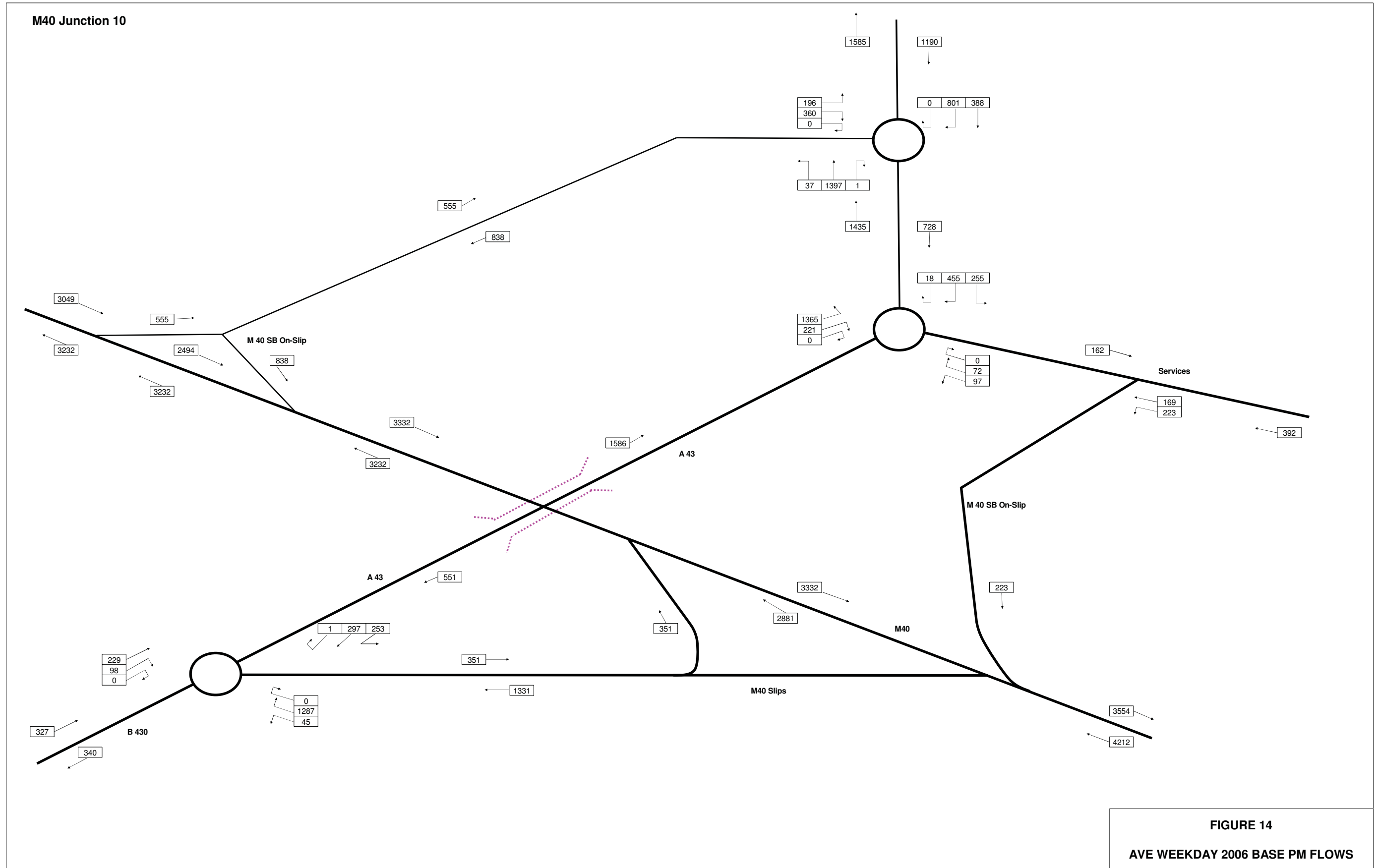


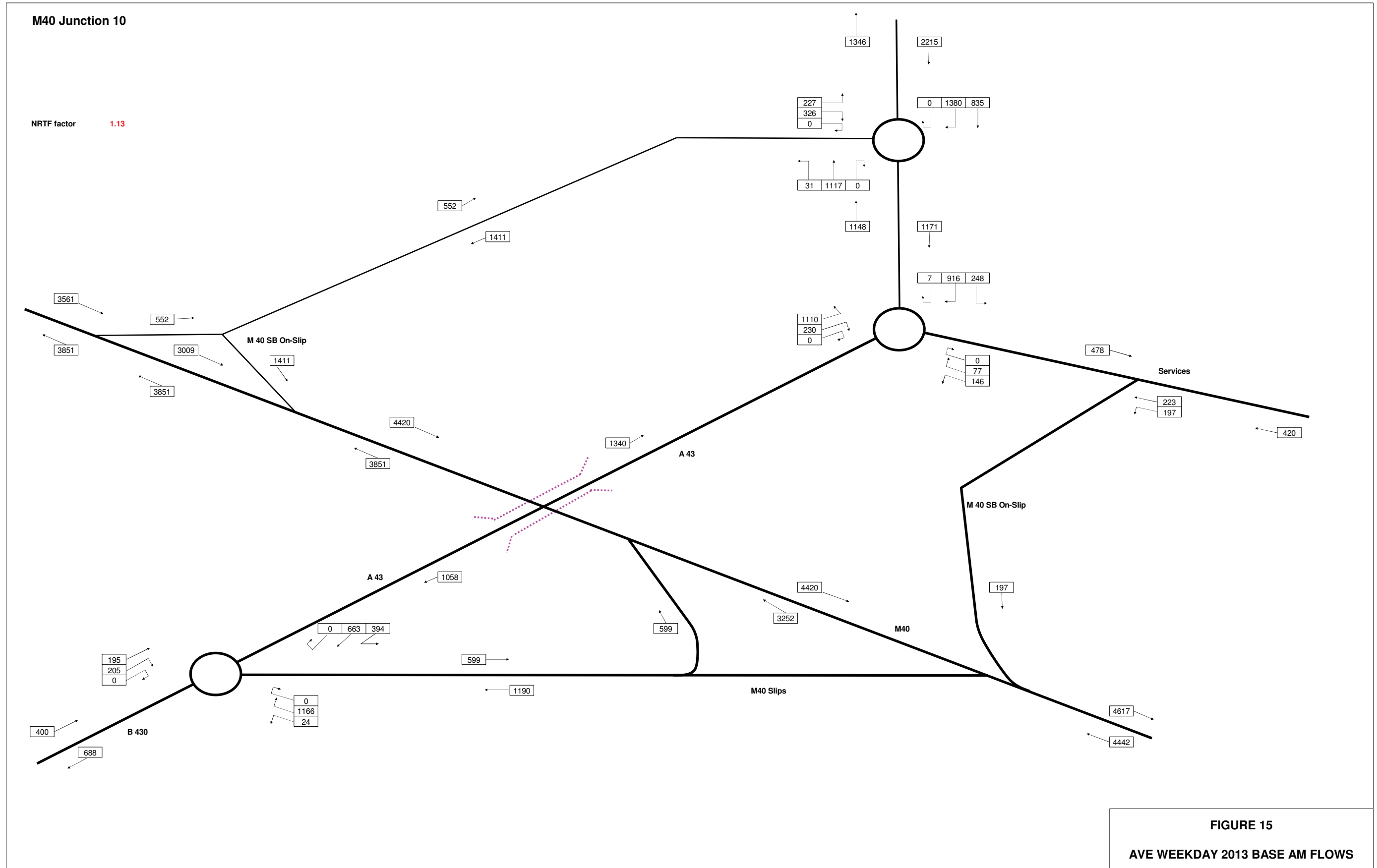
FIGURE 10
AVE WEEKDAY 2013 BASE PM FLOWS

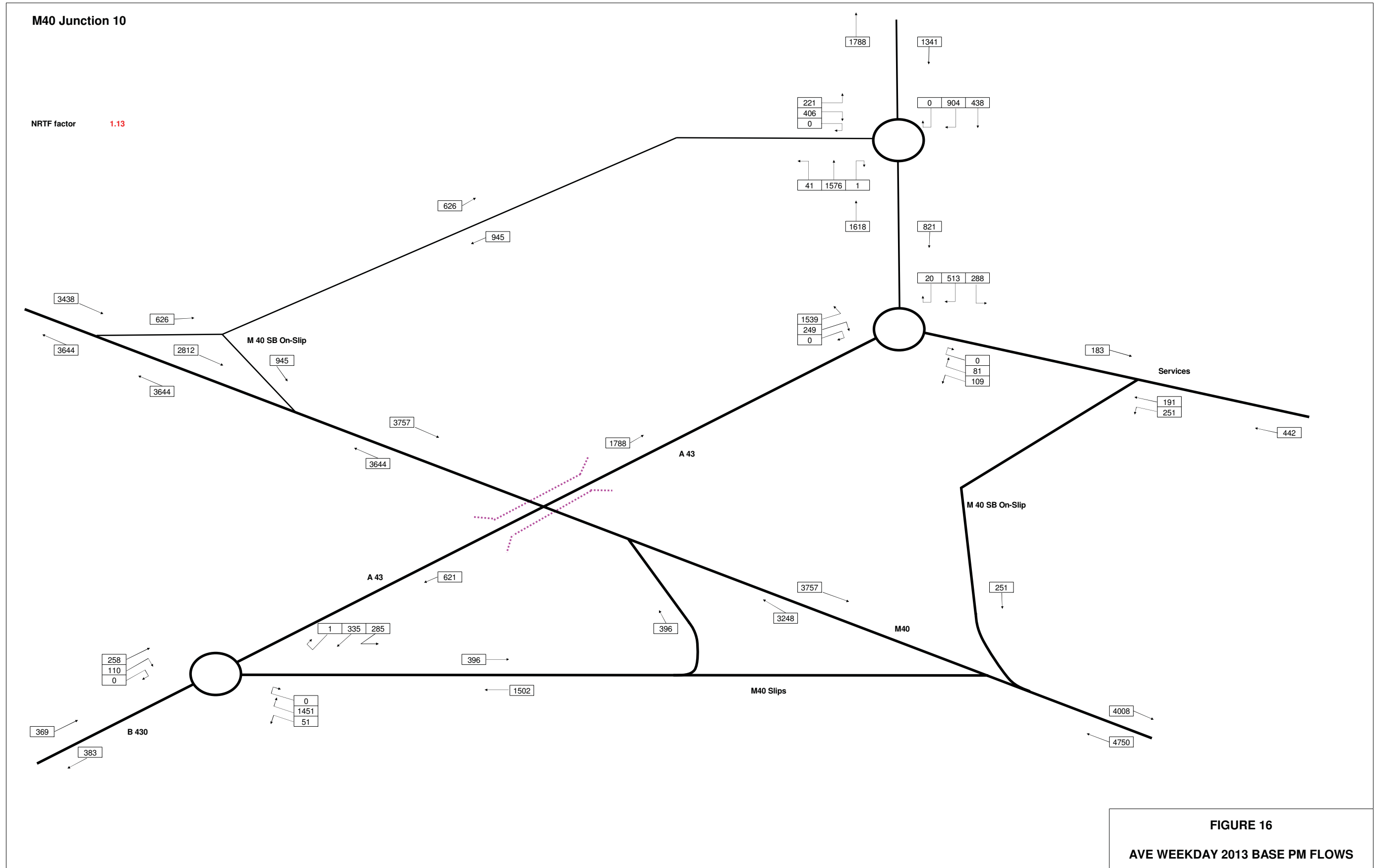


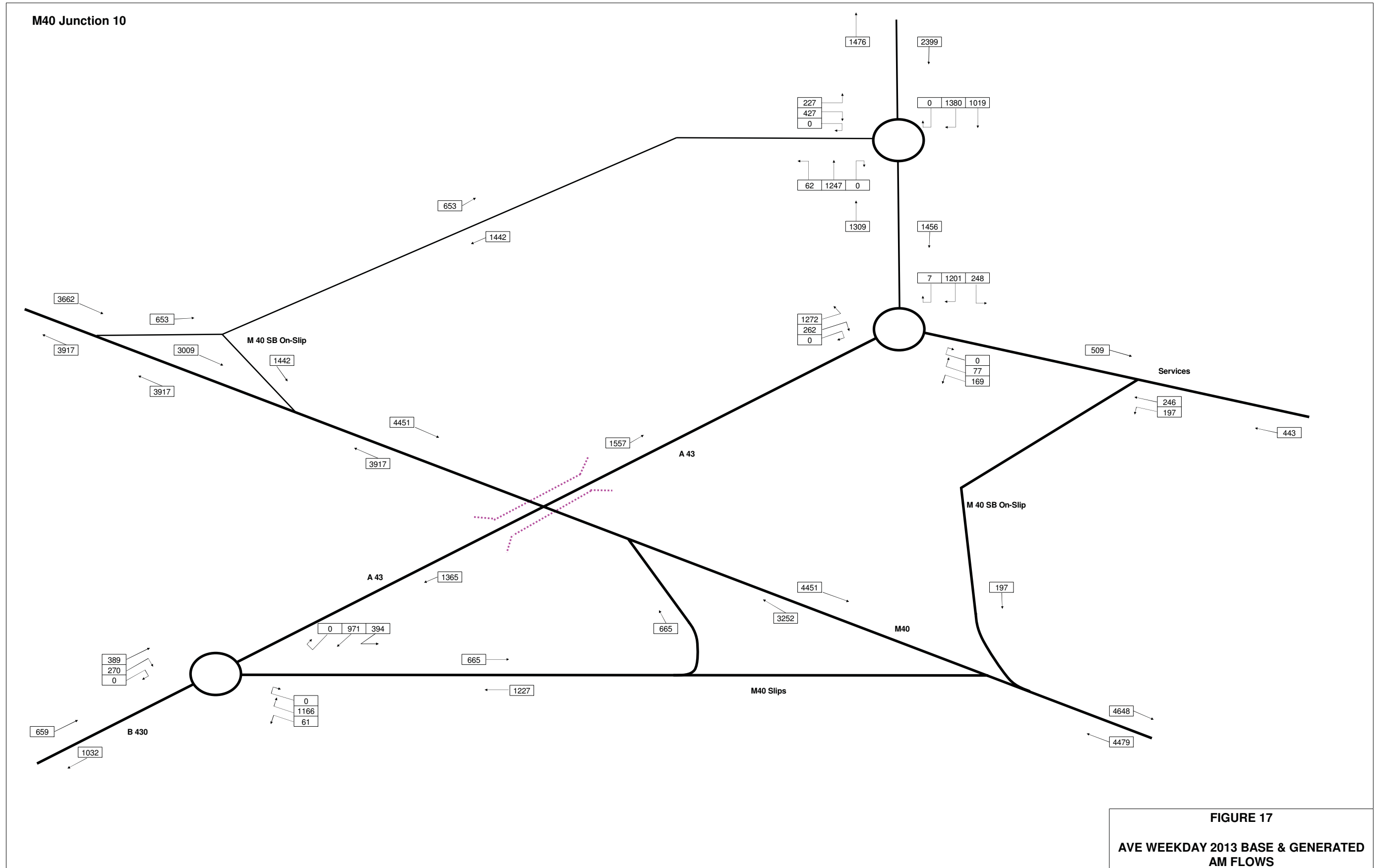


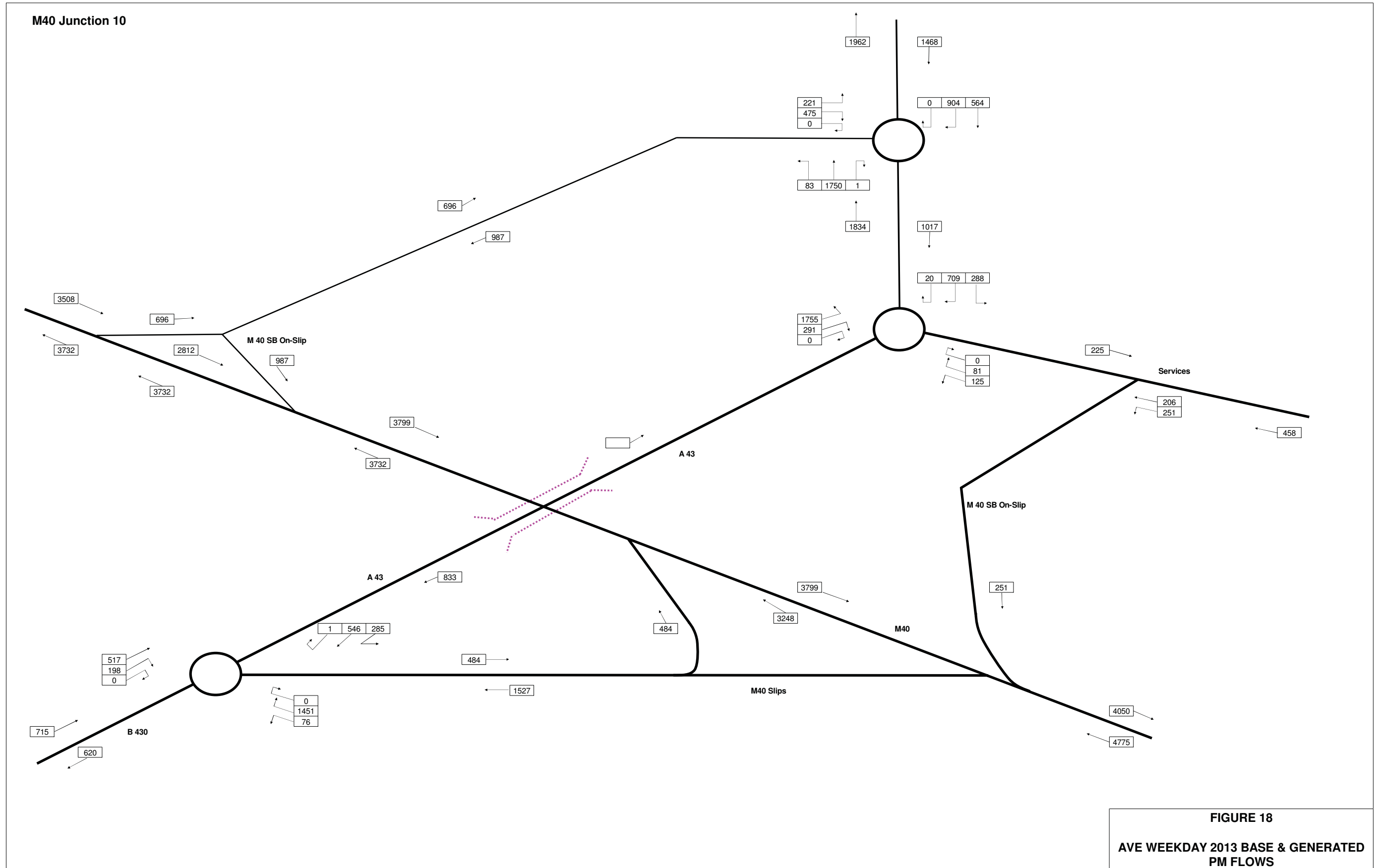


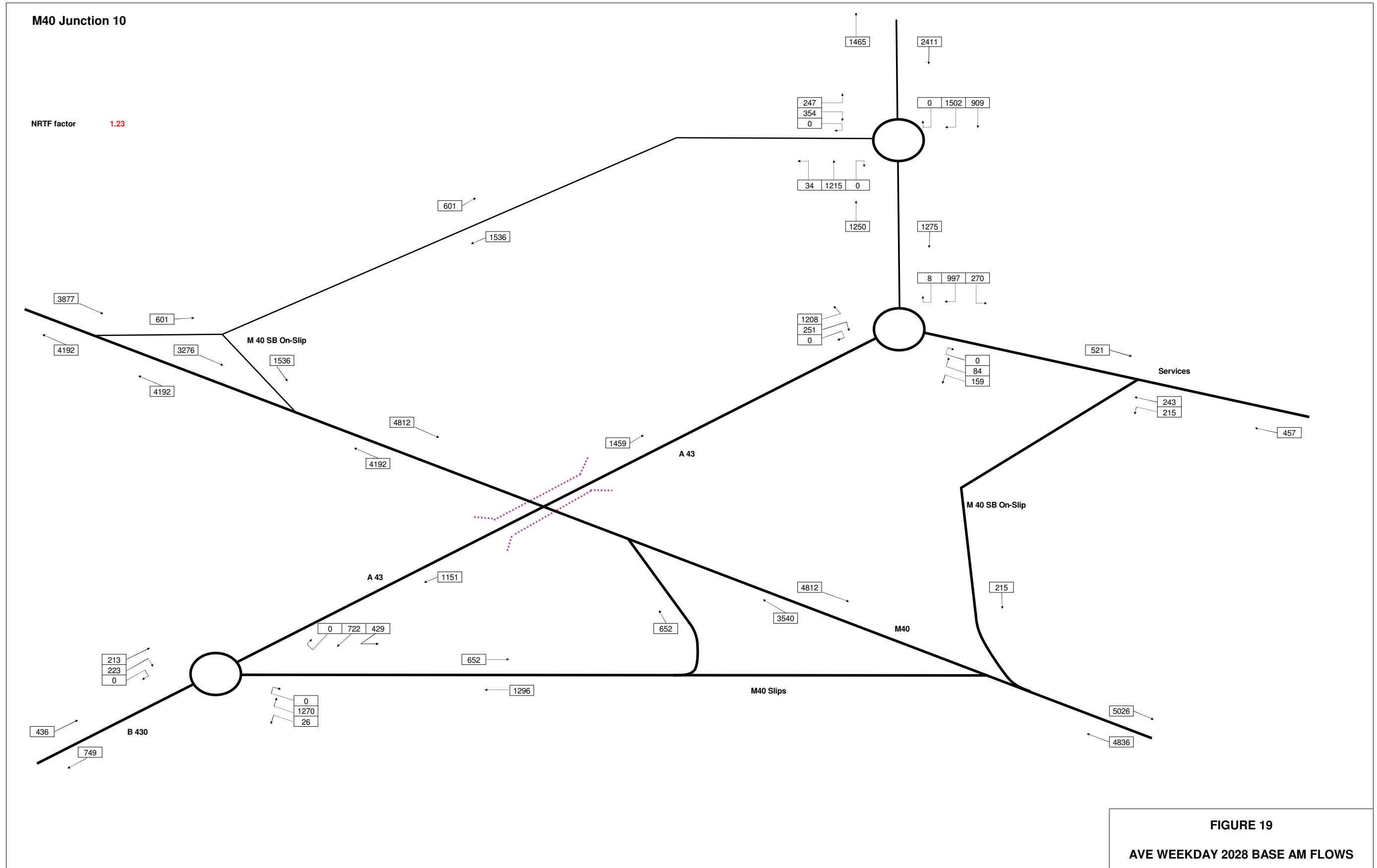


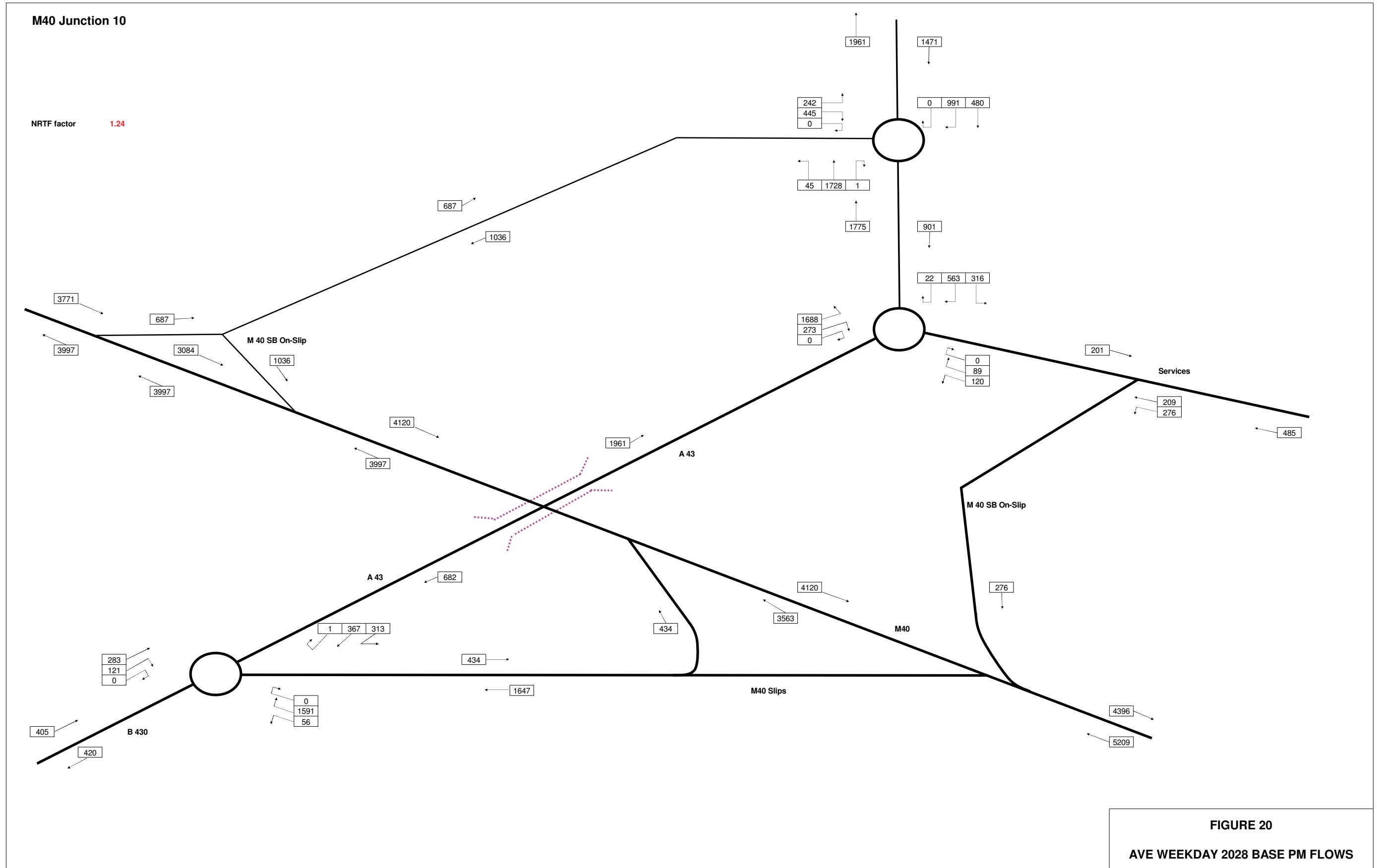


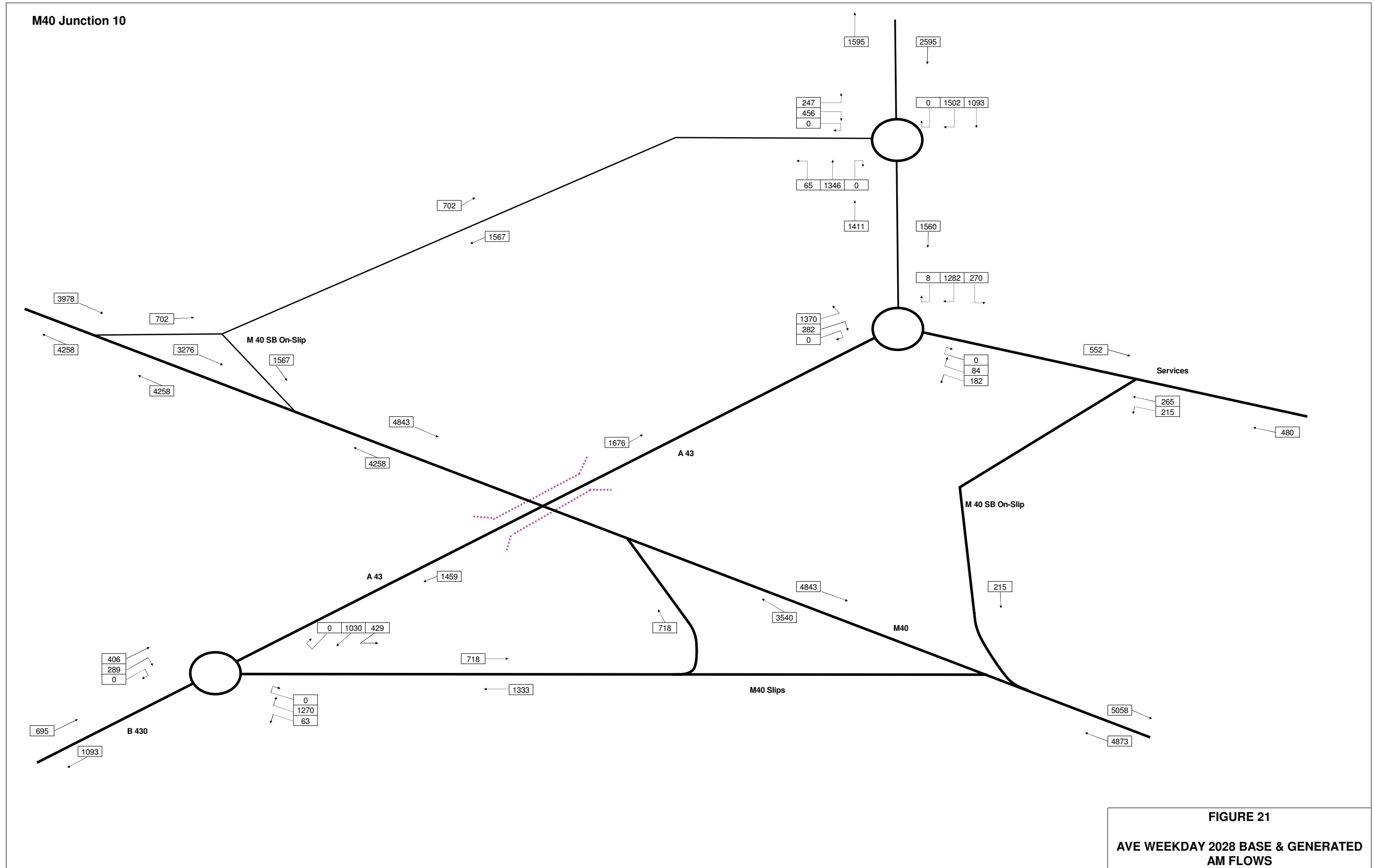












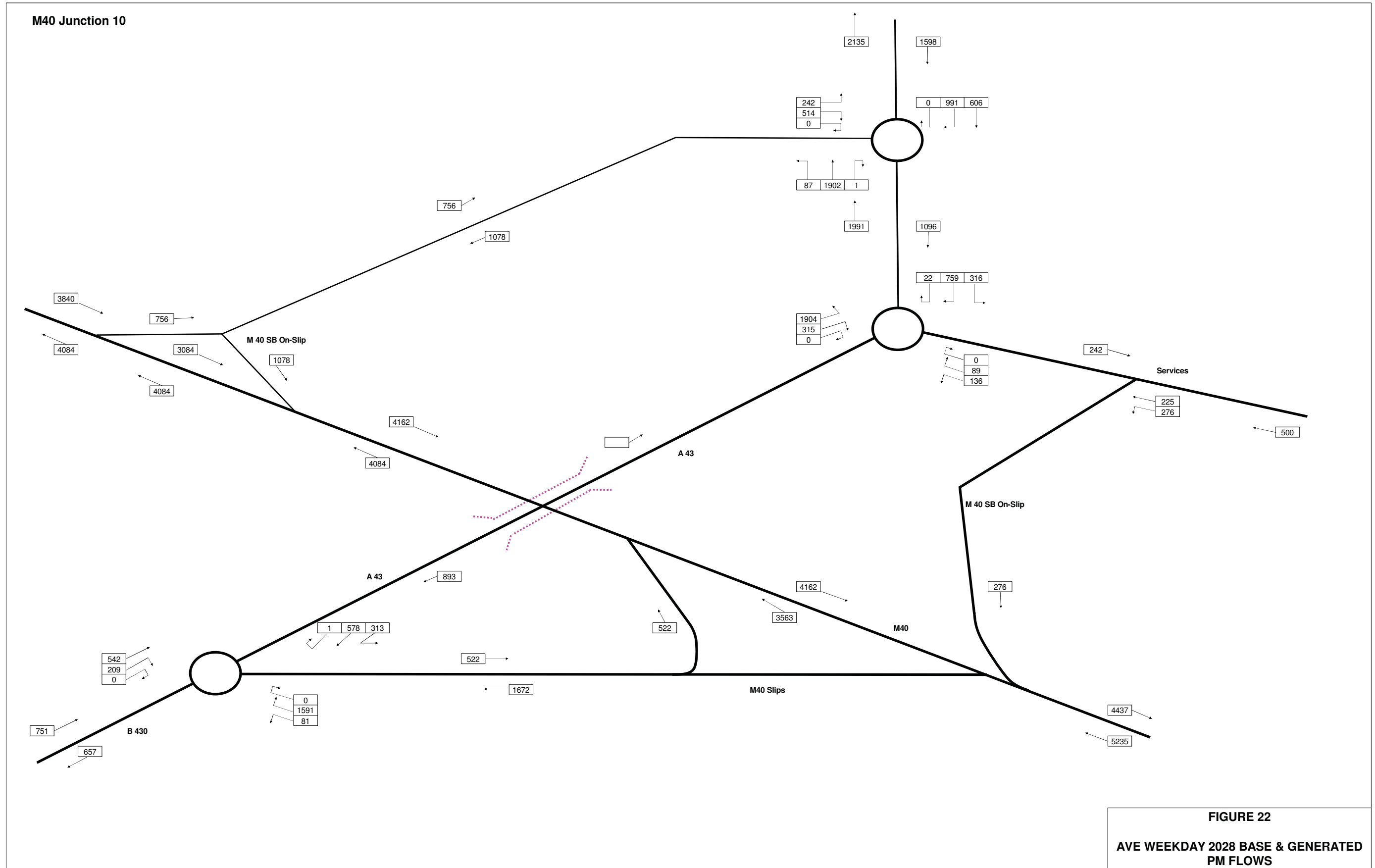


FIGURE 22
AVE WEEKDAY 2028 BASE & GENERATED PM FLOWS



J:\120000\120669-00\4 Internal Project Data\4-03 Drawings\Figure_23.dgn

Reproduced with the permission of Ordnance Survey on behalf of Her Majesty's Stationery Office. © Crown copyright (2007) All rights reserved. Licence Number 100039628

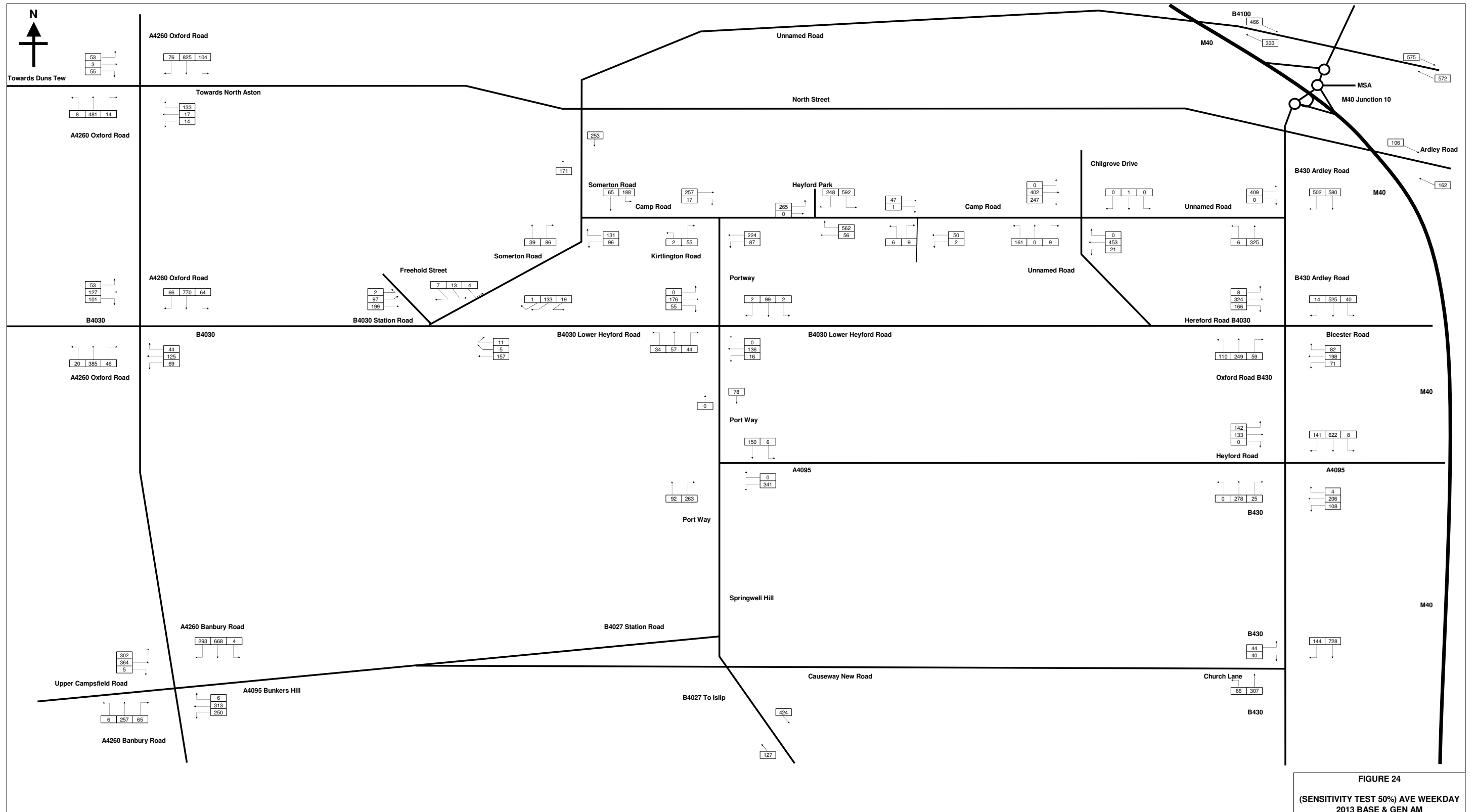
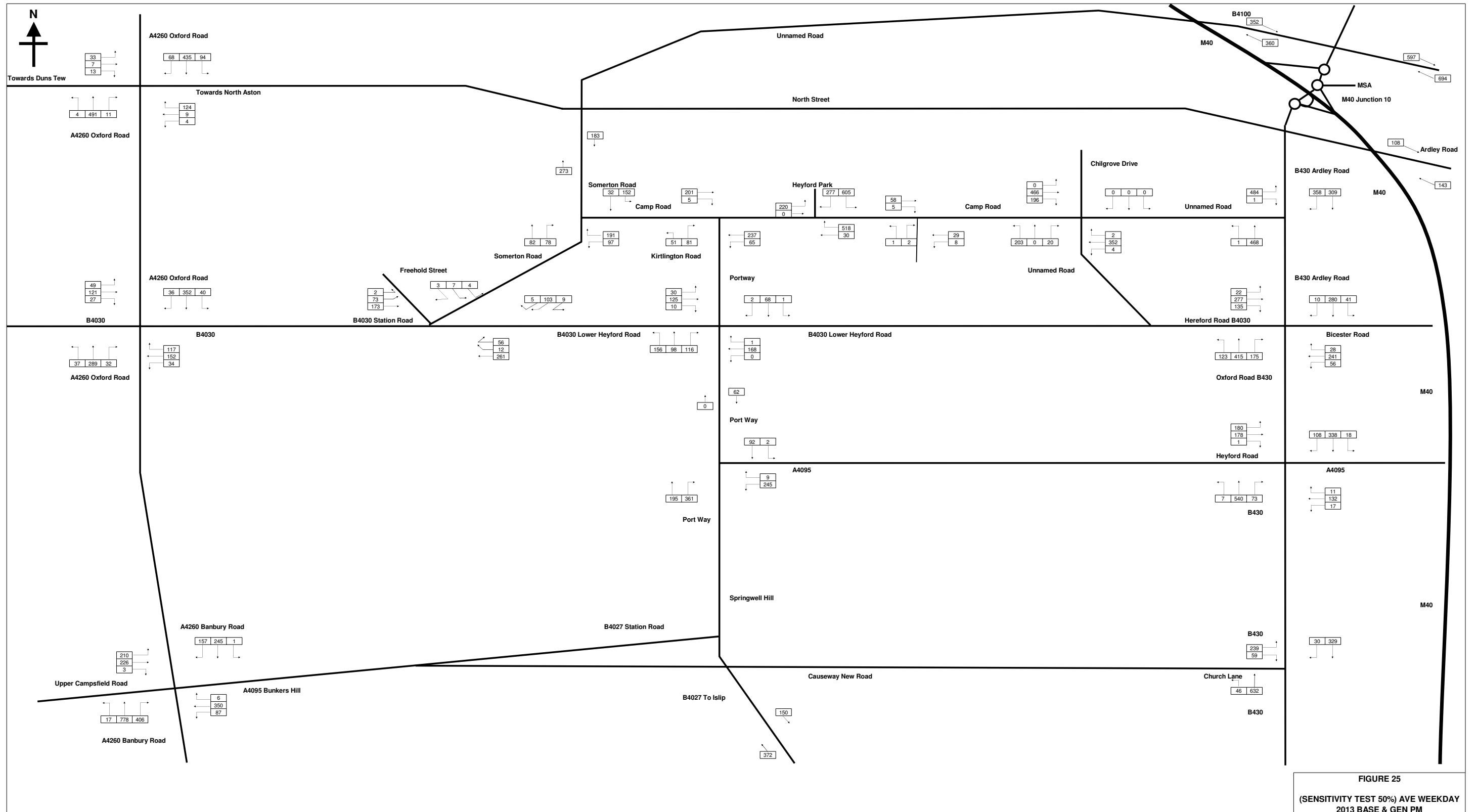
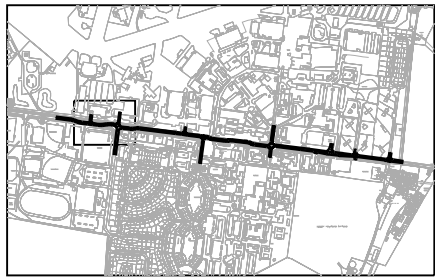
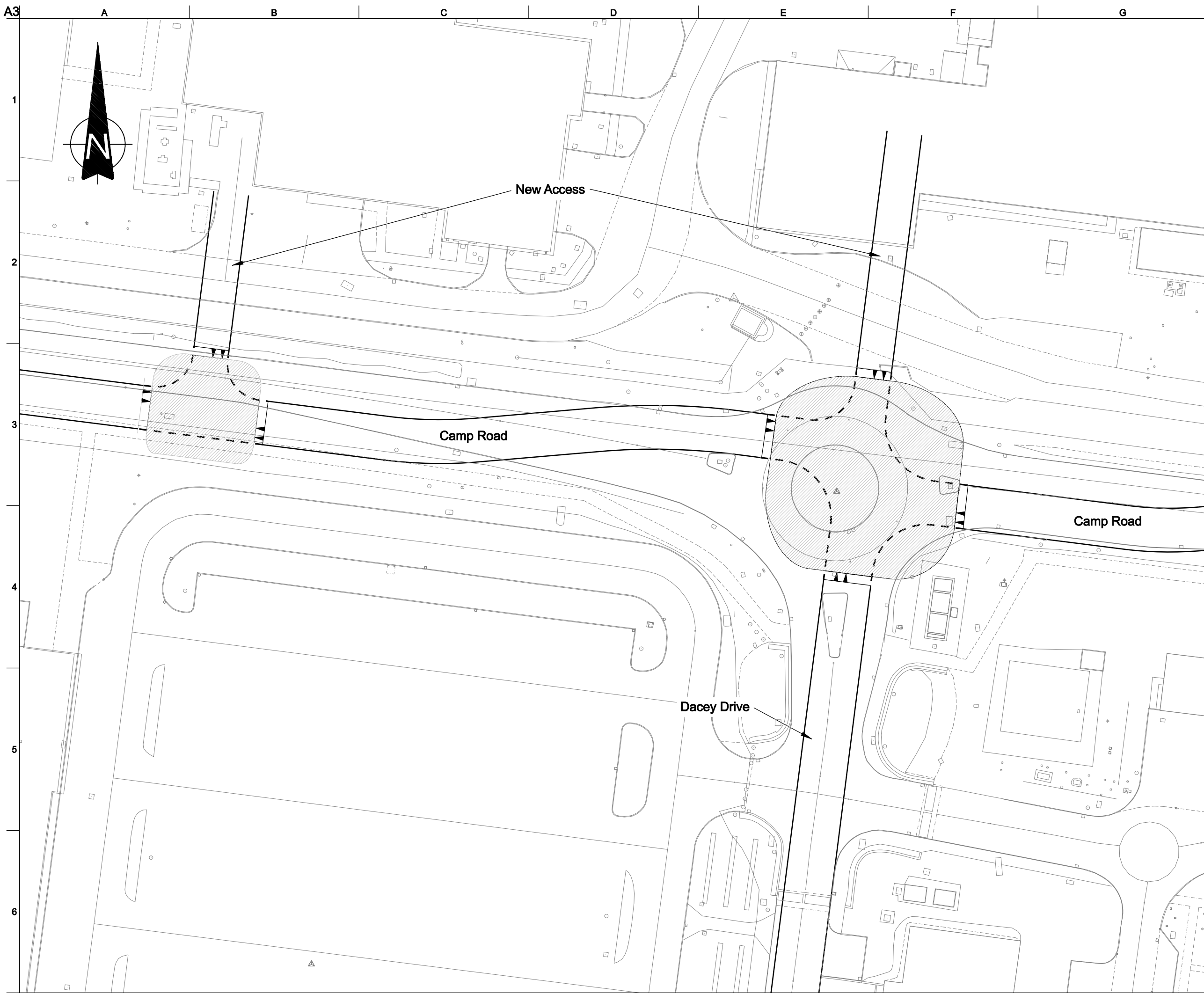


FIGURE 24
 (SENSITIVITY TEST 50%) AVE WEEKDAY
 2013 BASE & GEN AM





Key :
 Junction raised to kerb level

| | | | | |
|-------------|----------|----|-----|-----|
| 01 | 31/07/07 | KJ | IGC | IGC |
| First Issue | | | | |

| Issue | Date | By | Chkd | Appd |
|-------|------|----|------|------|
|-------|------|----|------|------|

ARUP
 The Arup Campus, Blythe Gate, Blythe Valley Park
 Solihull, West Midlands B90 8AE
 Tel +44(0)121 213 3000 Fax +44(0)121 213 3001
 www.arup.com

Client
North Oxfordshire Consortium

Job Title
**Heyford Park
 Transport Assessment**

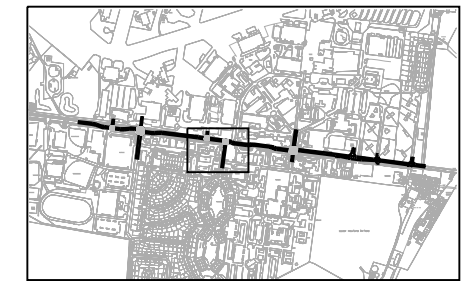
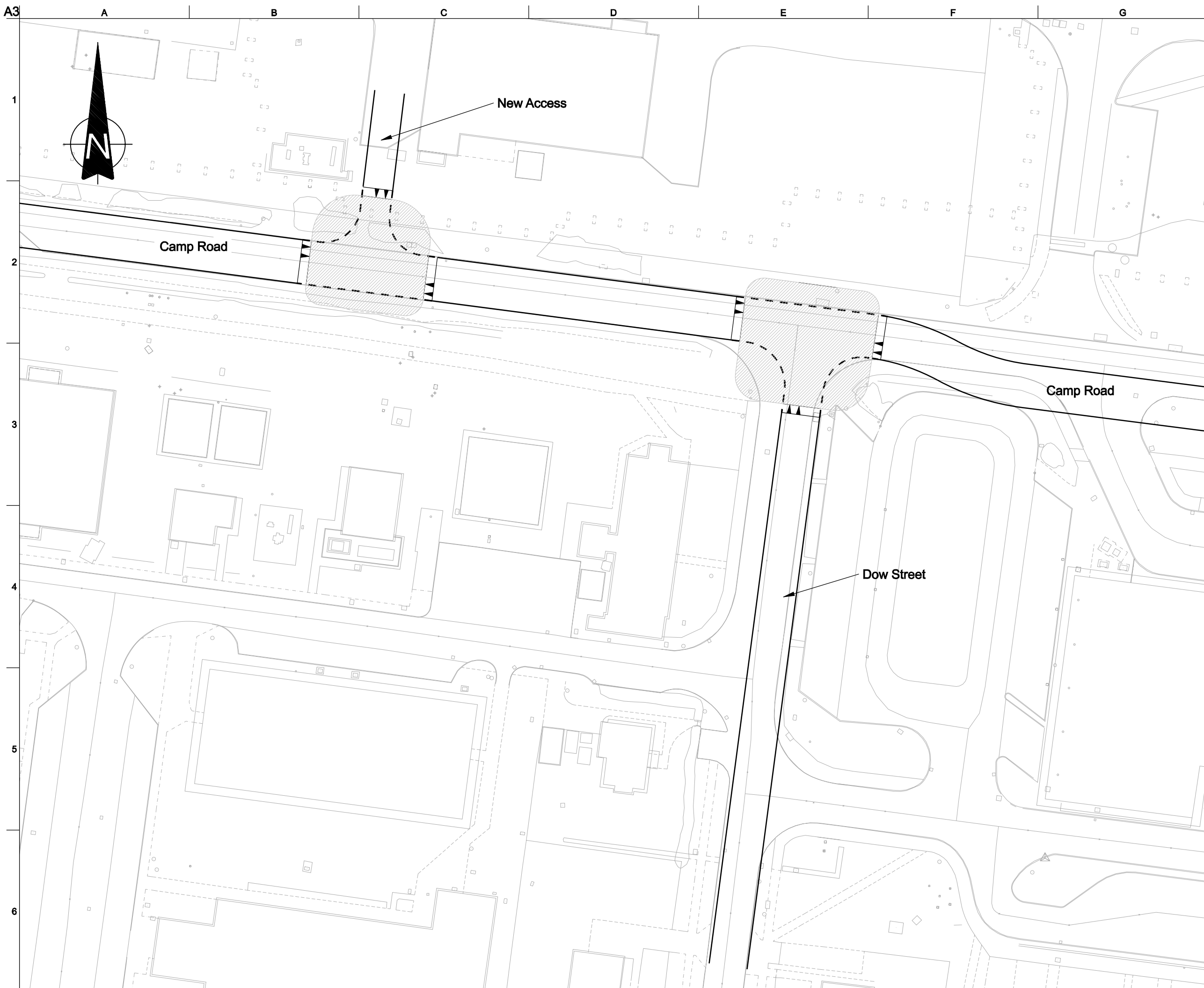
Drawing Title
**Camp Road Accesses to
 Development 1 : Dacey Drive**

Scale at A3
1:500

Plot ID

Drawing Status
Information

| | | |
|----------------------------|--------------------------------|--------------------|
| Job No 120669-00 | Drawing No Figure 26 | Issue 01 |
|----------------------------|--------------------------------|--------------------|



Key :
 Junction raised to kerb level

| | | | | |
|-------------|----------|----|-----|-----|
| 01 | 31/07/07 | KJ | IGC | IGC |
| First Issue | | | | |

| Issue | Date | By | Chkd | Appd |
|-------|------|----|------|------|
| | | | | |

ARUP

The Arup Campus, Blythe Gate, Blythe Valley Park
 Solihull, West Midlands B90 8AE
 Tel +44(0)121 213 3000 Fax +44(0)121 213 3001
 www.arup.com

Client
North Oxfordshire Consortium

Job Title
**Heyford Park
 Transport Assessment**

Drawing Title
**Camp Road Accesses to
 Development 2 : Dow Street**

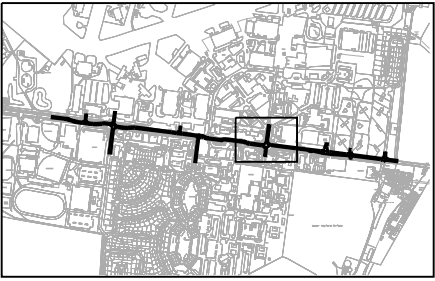
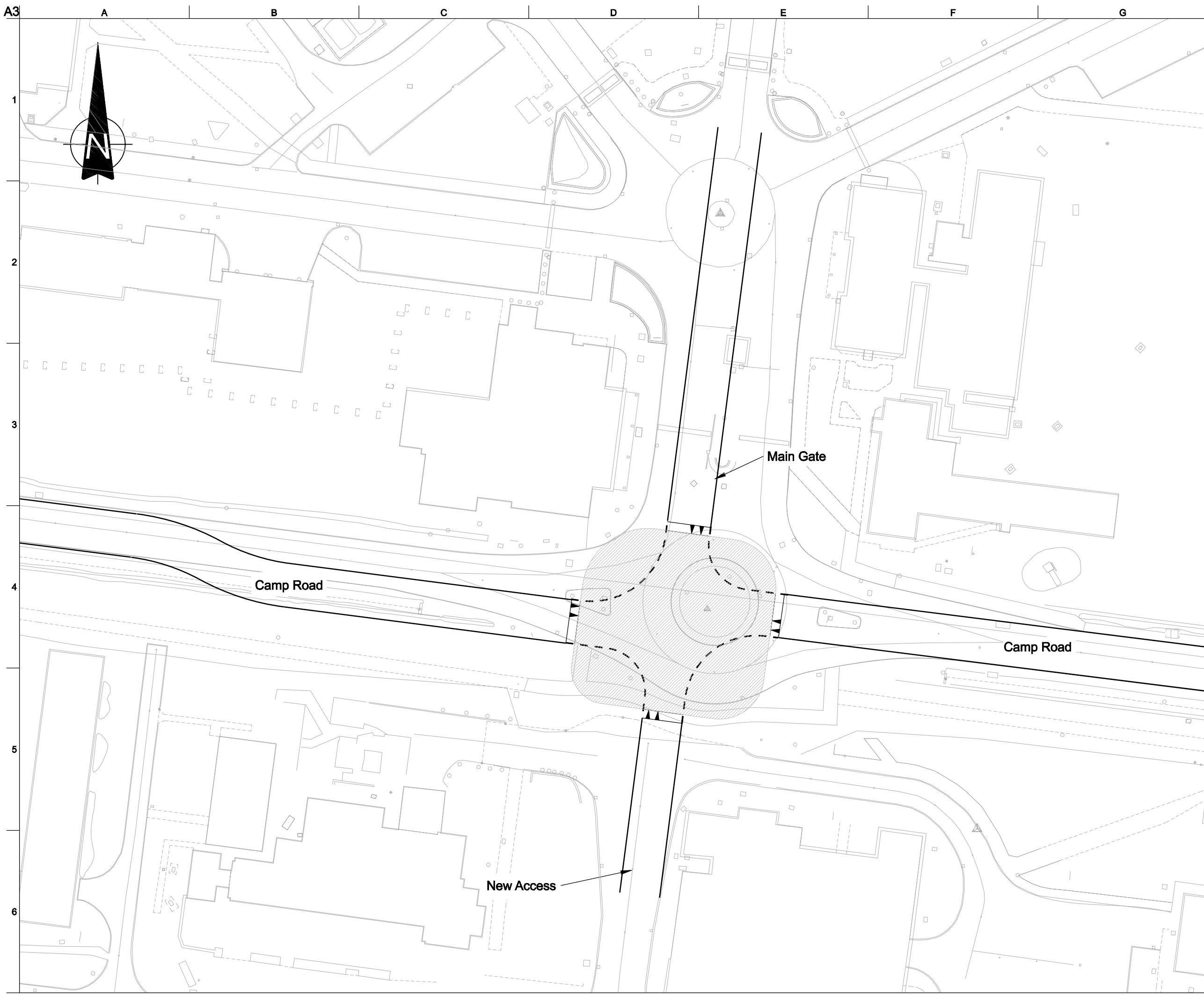
Scale at A3
1:500

Plot ID

Drawing Status

Information

| | | |
|----------------------------|--------------------------------|--------------------|
| Job No 120669-00 | Drawing No Figure 27 | Issue 01 |
|----------------------------|--------------------------------|--------------------|



Key :
 Junction raised to kerb level

| | | | | |
|-------------|----------|----|-----|-----|
| 01 | 31/07/07 | KJ | IGC | IGC |
| First Issue | | | | |

| Issue | Date | By | Chkd | Appd |
|-------|------|----|------|------|
| | | | | |

ARUP
 The Arup Campus, Blythe Gate, Blythe Valley Park
 Solihull, West Midlands B90 8AE
 Tel +44(0)121 213 3000 Fax +44(0)121 213 3001
 www.arup.com

Client
North Oxfordshire Consortium

Job Title
**Heyford Park
 Transport Assessment**

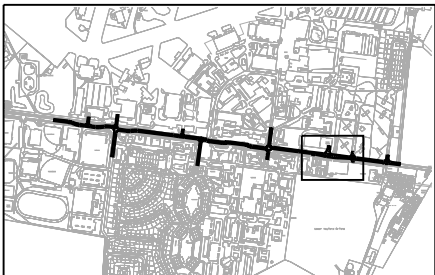
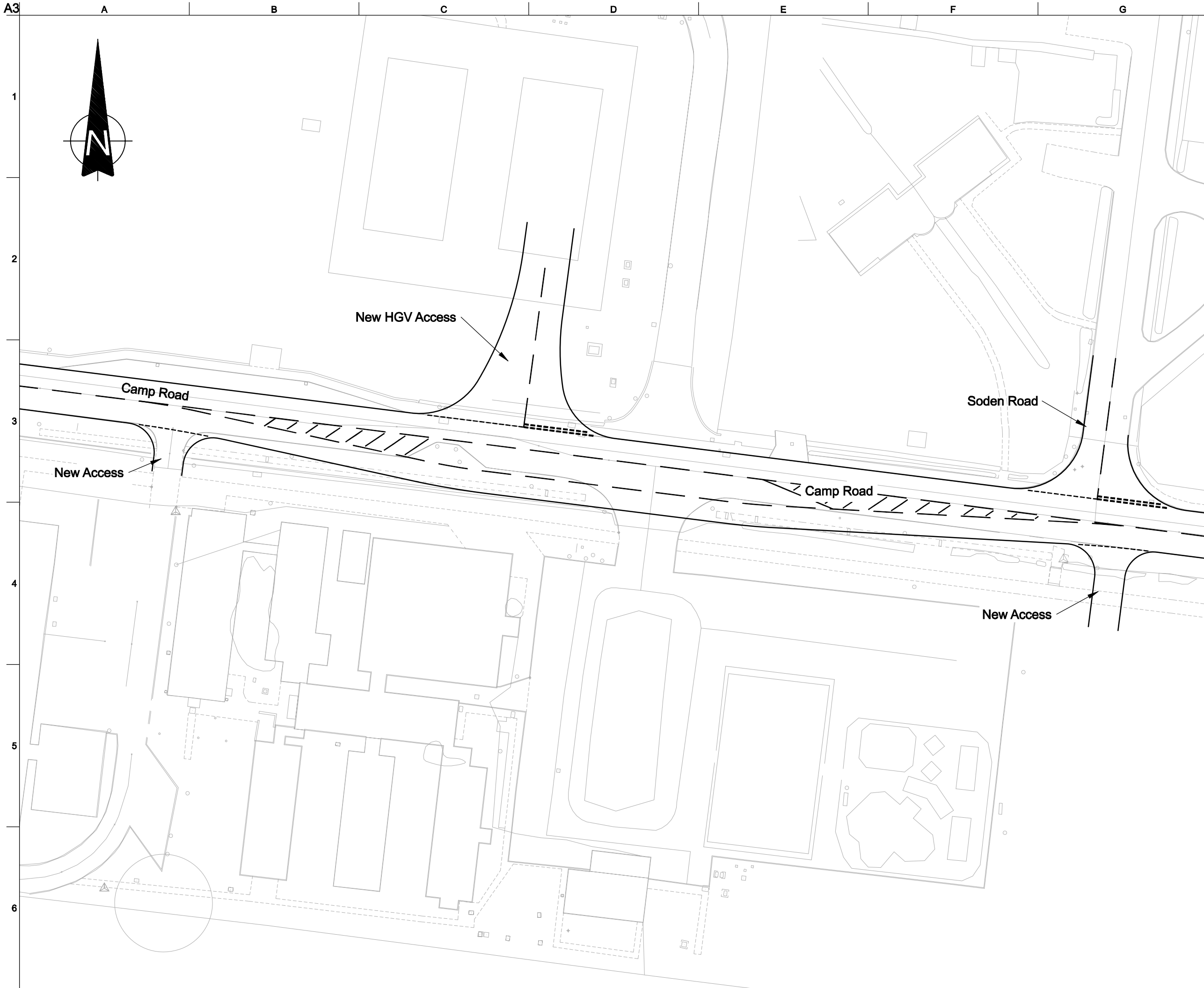
Drawing Title
**Camp Road Accesses to
 Development 3 : Main Gate**

Scale at A3
 1:500

Plot ID

Drawing Status
Information

| | | |
|----------------------------|--------------------------------|--------------------|
| Job No 120669-00 | Drawing No Figure 28 | Issue 01 |
|----------------------------|--------------------------------|--------------------|



| | | | | |
|-------------|----------|----|-----|-----|
| 01 | 31/07/07 | KJ | IGC | IGC |
| First Issue | | | | |

| Issue | Date | By | Chkd | Appd |
|-------|------|----|------|------|
|-------|------|----|------|------|

ARUP

The Arup Campus, Blythe Gate, Blythe Valley Park
 Solihull, West Midlands B90 8AE
 Tel +44(0)121 213 3000 Fax +44(0)121 213 3001
 www.arup.com

Client
North Oxfordshire Consortium

Job Title
**Heyford Park
 Transport Assessment**

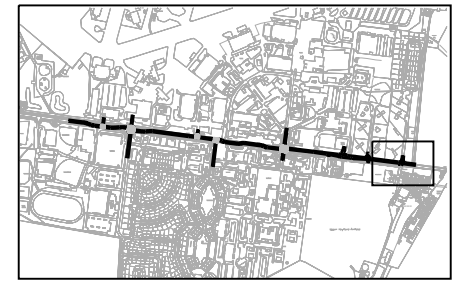
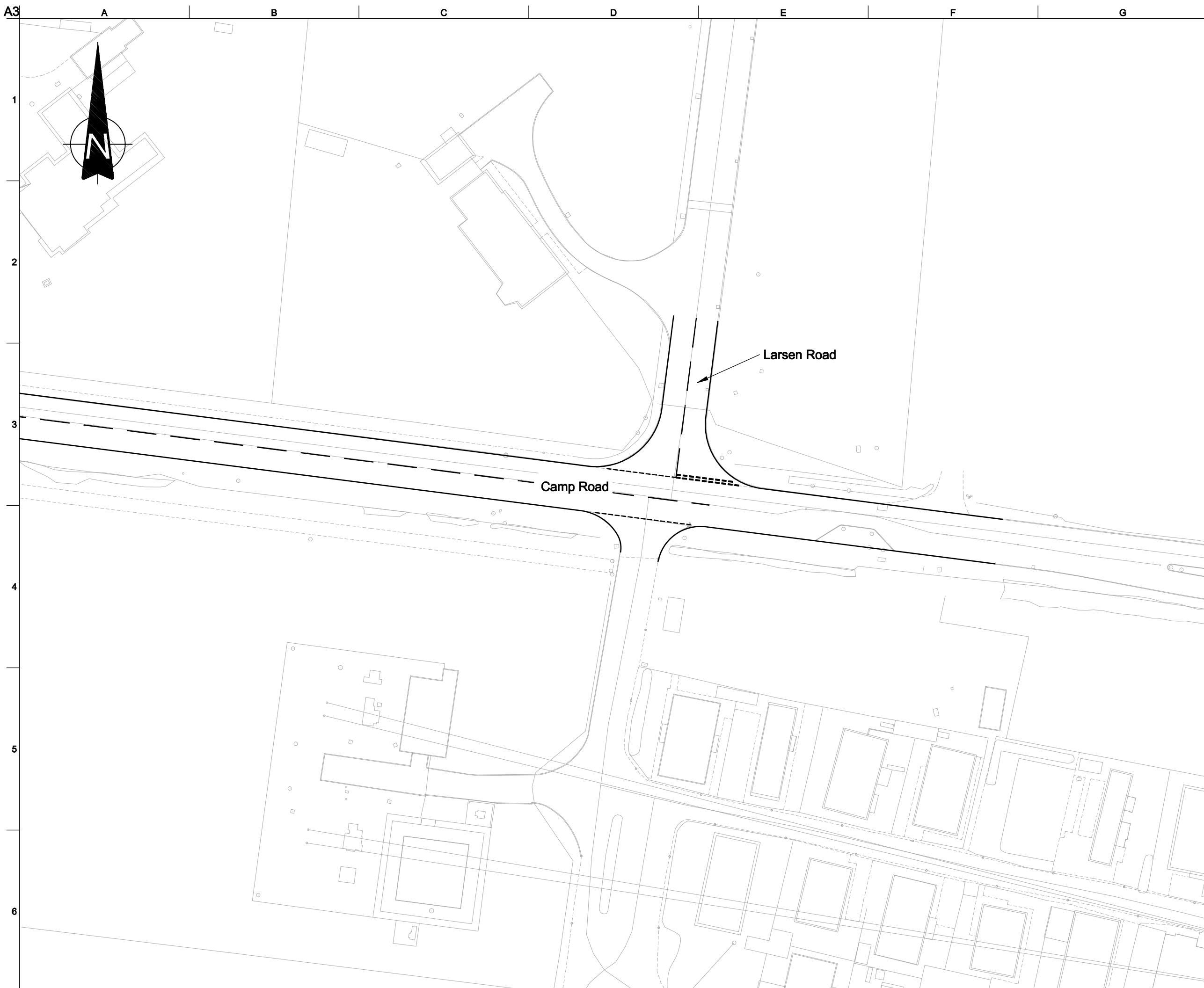
Drawing Title
**Camp Road Accesses to
 Development 4 : HGV Access**

Scale at A3
1:500

Plot ID

Drawing Status
Information

| | | |
|----------------------------|--------------------------------|--------------------|
| Job No 120669-00 | Drawing No Figure 29 | Issue 01 |
|----------------------------|--------------------------------|--------------------|



| | | | | |
|-------------|----------|----|-----|-----|
| 01 | 31/07/07 | KJ | IGC | IGC |
| First Issue | | | | |

| Issue | Date | By | Chkd | Appd |
|-------|------|----|------|------|
|-------|------|----|------|------|

ARUP

The Arup Campus, Blythe Gate, Blythe Valley Park
 Solihull, West Midlands B90 8AE
 Tel +44(0)121 213 3000 Fax +44(0)121 213 3001
 www.arup.com

Client
North Oxfordshire Consortium

Job Title
**Heyford Park
 Transport Assessment**

Drawing Title
**Camp Road Accesses to
 Development 5 : Larsen Road**

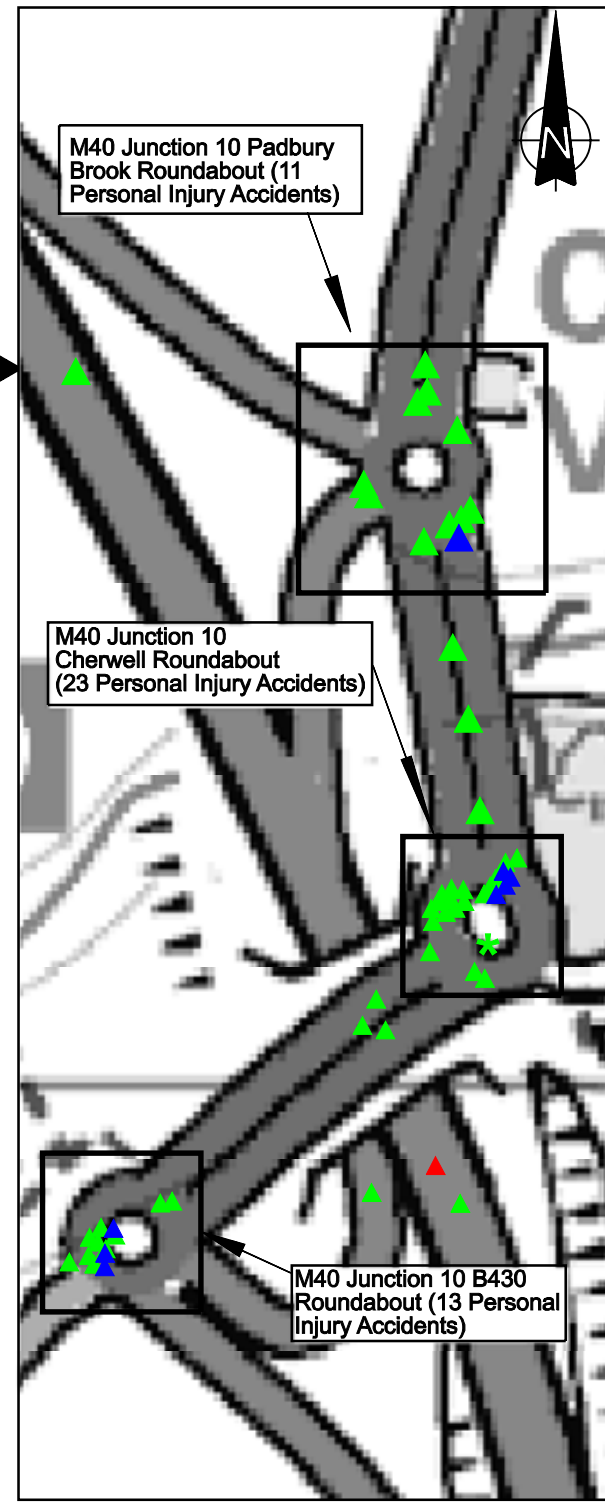
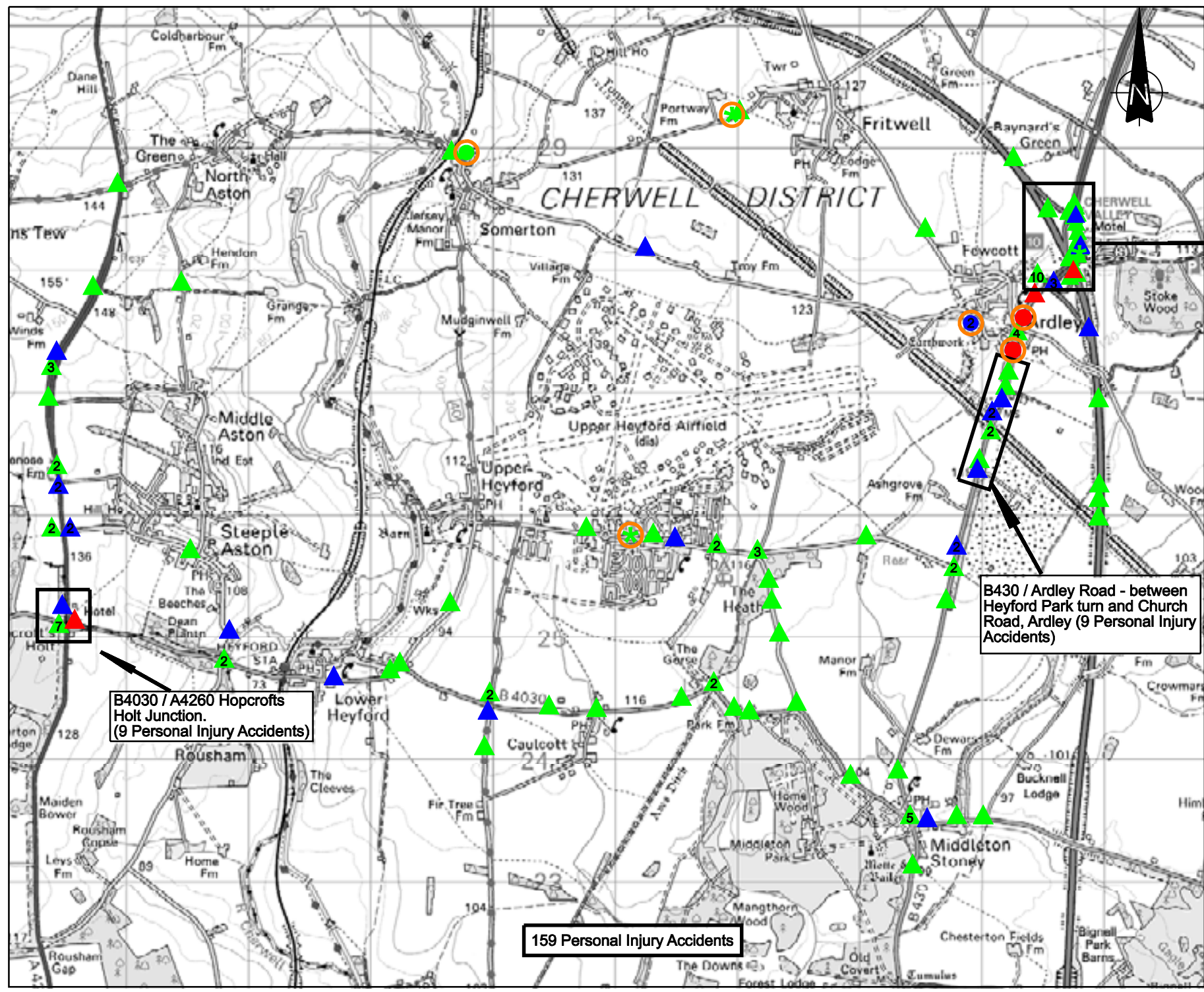
Scale at A3
1:500

Plot ID

Drawing Status

Information

| | | |
|----------------------------|--------------------------------|--------------------|
| Job No 120669-00 | Drawing No Figure 30 | Issue 01 |
|----------------------------|--------------------------------|--------------------|



Key

- Ped Slight
- Ped Severe
- Ped Fatal
- ✱ Cycle Slight
- ▲ Vehicle Slight
- ▲ Vehicle Severe
- ▲ Vehicle Fatal
- Vulnerable Road User Accident
- Cluster

| | | | | |
|-------------|----------|----|-----|-----|
| 01 | 05/04/07 | KJ | CJM | PAS |
| First Issue | | | | |

| Issue | Date | By | Chkd | Appd |
|-------|------|----|------|------|
| | | | | |

ARUP

The Arup Campus, Blythe Gate, Blythe Valley Park
 Solihull, West Midlands B90 8AE
 Tel +44(0)121 213 3000 Fax +44(0)121 213 3001
 www.arup.com

Client
North Oxfordshire Consortium

Job Title
**Heyford Park
 Transport Assessment**

Drawing Title
**Personal Injury Accidents -
 Location Plan**

Scale at A3
 N.T.S.

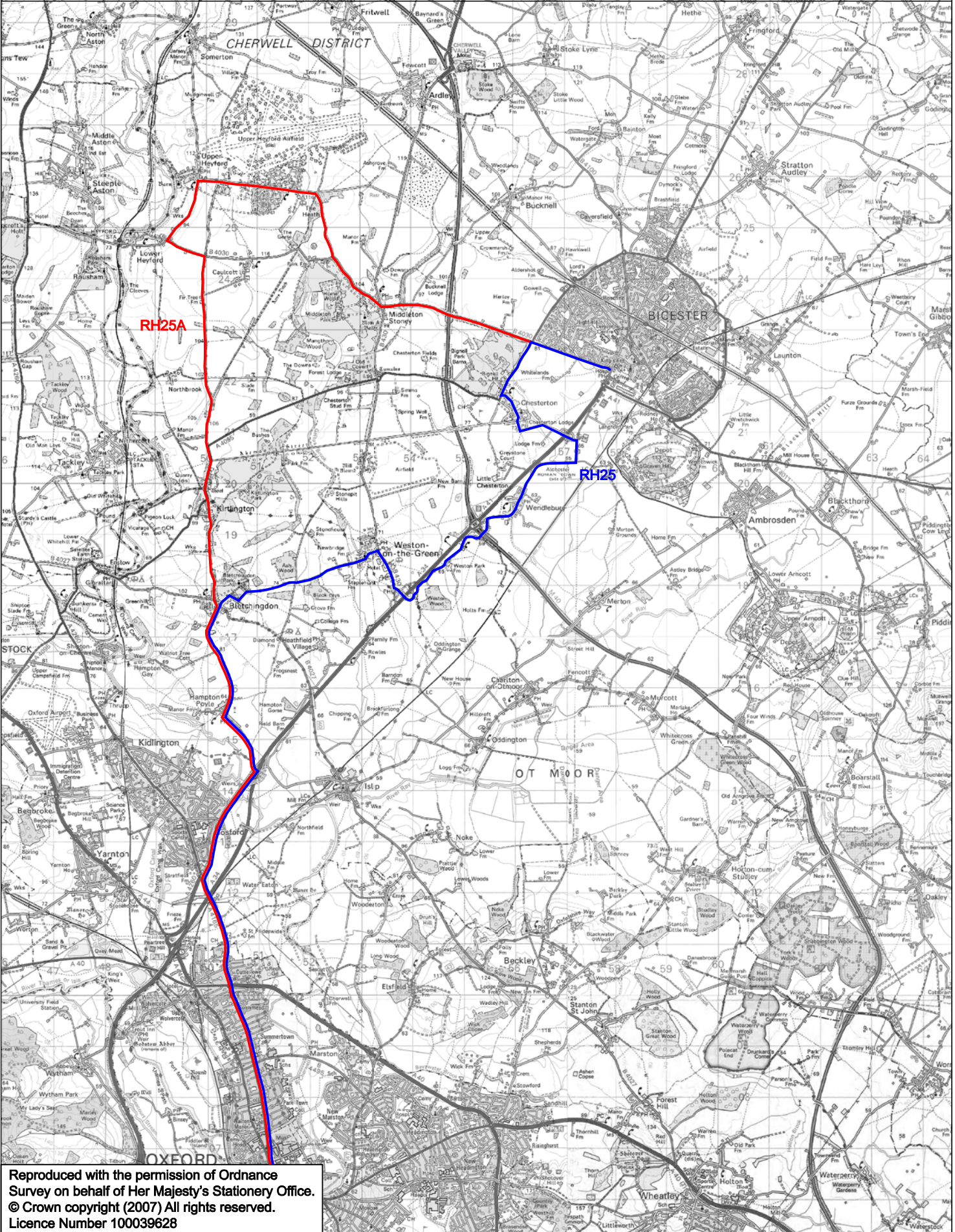
Plot ID

Drawing Status

Information

| | | |
|----------------------------|--------------------------------|--------------------|
| Job No 120669-00 | Drawing No Figure 31 | Issue 01 |
|----------------------------|--------------------------------|--------------------|

Reproduced with the permission of Ordnance Survey on behalf of Her Majesty's Stationery Office. © Crown copyright (2007) All rights reserved. Licence Number 100039628.



Reproduced with the permission of Ordnance Survey on behalf of Her Majesty's Stationery Office. © Crown copyright (2007) All rights reserved. Licence Number 100039628

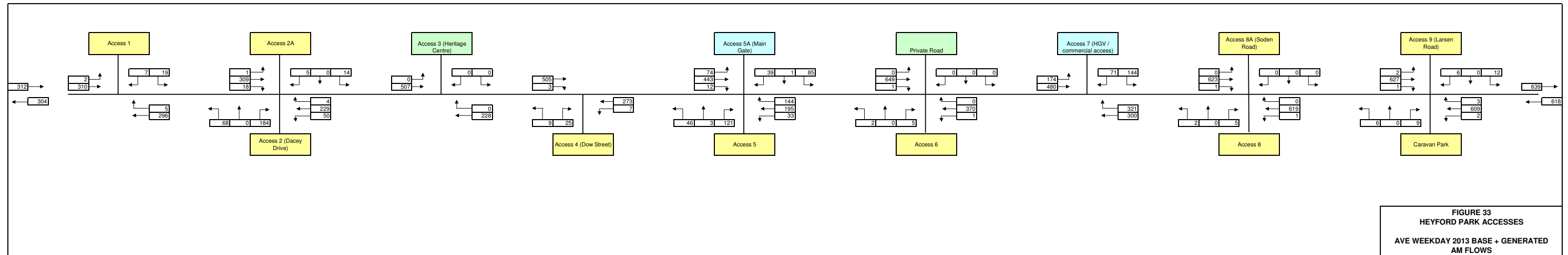
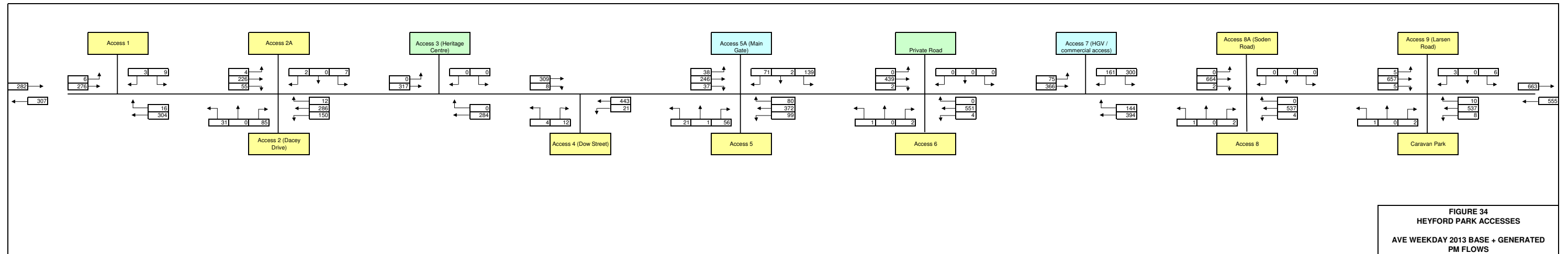
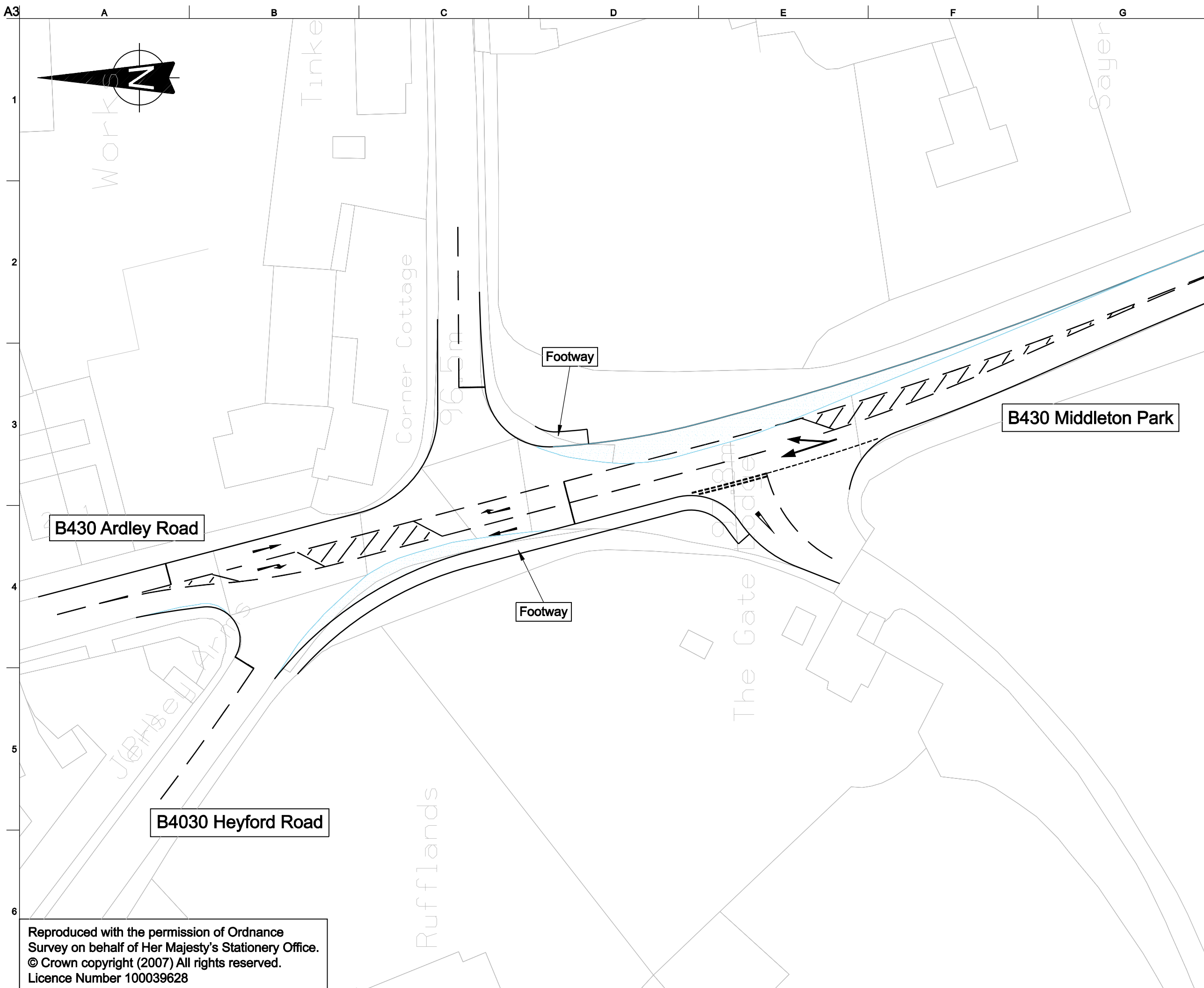


FIGURE 33
HEYFORD PARK ACCESSES
AVE WEEKDAY 2013 BASE + GENERATED
AM FLOWS





Key:
 Areas of carriageway widening

| | | | | |
|-------------|----------|----|------|------|
| 01 | 09/08/07 | NS | IGC | IGC |
| First Issue | | | | |
| Issue | Date | By | Chkd | Appd |

ARUP

The Arup Campus, Blythe Gate, Blythe Valley Park
 Solihull, West Midlands B90 8AE
 Tel +44(0)121 213 3000 Fax +44(0)121 213 3001
 www.arup.com

Client
North Oxfordshire Consortium

Job Title
**Heyford Park
 Transport Assessment**

Drawing Title
**Proposed Alterations to Junction
 Between B4030 and B430
 in Middleton Stoney**

Scale at A3
 1:500

Plot ID

Drawing Status

Information

| | | |
|------------------|------------------|-----------|
| Job No | Drawing No | Issue |
| 120669-00 | Figure 35 | 01 |

Reproduced with the permission of Ordnance Survey on behalf of Her Majesty's Stationery Office. © Crown copyright (2007) All rights reserved. Licence Number 100039628



| | | | | |
|-------------|----------|-----|------|------|
| 01 | 15/08/07 | PJD | IGC | IGC |
| First Issue | | | | |
| Issue | Date | By | Chkd | Appd |

ARUP

The Arup Campus, Blythe Gate, Blythe Valley Park
 Solihull, West Midlands B90 8AE
 Tel +44(0)121 213 3000 Fax +44(0)121 213 3001
 www.arup.com

Client
North Oxfordshire Consortium

Job Title
**Heyford Park
 Transport Assessment**

Drawing Title
**Figure 36
 Junction 10: Proposed carriageway
 marking alterations**

Scale at A3
1:1000

Plot ID

Drawing Status
Information

| | | |
|------------------|------------------|-----------|
| Job No | Drawing No | Issue |
| 120669-00 | Figure_36 | 01 |

Existing

Proposed

Diagram 1003.1

Diagram No 1004.1

Appendix A

**Transport Assessment
Scoping Note**

Transport Assessment Scoping Note

Introduction

Arup has been commissioned by North Oxfordshire Consortium to undertake a Transport Assessment for the proposed development of the former military airbase at Upper Heyford in Oxfordshire.

The scope of the Transport Assessment was discussed at a meeting held with Tony Clark and Suzanne Roberts of Oxfordshire County Council, the Highway Authority, and Douglas Rounthwaite of the Highways Agency at Oxfordshire County Council offices on 5th July 2006 and at a further meeting with Tony Clark and Suzanne Roberts on 4th October supplemented by telephone conversations and e-mails.

This Scoping Note sets out the proposed coverage and methodology to be employed for the Transport Assessment.

Proposed Development

Details of the proposed development will be set out including:

- Description
- Development content
- Access arrangements

Planning & Policy Framework

The development will be examined within the context set by national guidance, the Local Transport Plan, the Structure/Local Plans and Development Framework.

Travel Characteristics / Existing conditions

Base Traffic Data will be established based on the surveys agreed at the meeting on 5th July. A description and plan of the local highway network will be provided along with details of the current performance of 9 key junctions:

- A4260 crossroads junction between Duns Tew and North Aston
- A4260 crossroads with B4030 at Hopcrofts Holt
- A4260 staggered crossroads with A4095
- B4030 staggered crossroads with B430 at Middleton Stoney
- B430 between Middleton Stoney and Ardley – junction with minor road to Upper Heyford
- Chilgrove Drive crossroad immediately east of Upper Heyford airfield
- Minor junction on Camp Road immediately east of Upper Heyford village
- 'T' junction in Upper Heyford village
- Junction of Portway with B4030

The attached map shows the junction locations.

Existing public transport, walking and cycling facilities will be reviewed.

Highway Impacts

Trip rates

The following trip rates have been agreed with Oxfordshire County Council for traffic generation of the residential development.

| | Arrivals | Departures | Totals |
|---------|----------|------------|--------|
| AM peak | 0.17 | 0.63 | 0.8 |
| PM peak | 0.51 | 0.29 | 0.8 |

The mix of employment uses on the site, and the extent of existing commercial uses that are to be retained has not been finalised. It has therefore been agreed to develop two scenarios for the employment trip generation; a 'most likely' case based on the latest proposals in terms of retained uses and likely new uses, and a 'worse case' that will assume a higher proportion of B1 office use than is presently forecast.

Distribution

The directional distribution will be developed using travel to work origins and destinations from the Office for National Statistics census data. Heyford Park falls within the Heyford and the Astons Ward. Data will be disaggregated for an area enclosed approximately by the M40, A4260, Kirklington and Souldern.

The data will be validated against that for an area of recent residential development in south east Bicester.

Committed Development

Details of any committed development for inclusion will be obtained from Cherwell District Council.

Design years

In terms of impact assessment the opening year of the development (fully completed) is required by Oxfordshire County Council and the Highways Agency. In addition, the Highways Agency requires a test for 15 years after opening. Background growth from 2006 to test years will be calculated using TEMPRO.

Junction Assessments

Junction capacity assessments will be carried out at any junctions where traffic generated by the development represents an increase of 5% or greater in the test years.

The Highways Agency requires consideration of the impacts on Junction 10 of the M40 and possibly, Junction 9 (to be confirmed when traffic flows from the new development are established).

Appraisal of Impacts

Transport impacts will be summarised in a brief NATA style multi-criteria appraisal based on an Appraisal Summary Table and in accordance with the government's WebTAG guidance.

Mitigation

Consideration will be made of measures to mitigate the impact of traffic in the locality and particular surrounding villages. Access arrangements for commercial vehicles will be considered.

Accidents

The area for which accident data is to be collected has been agreed with Oxfordshire County Council. Accidents on the M40 main carriageways are to be excluded. Personal injury accident data will be obtained for the latest five year period, August 2001 to July 2006.

It is proposed that accidents will be grouped into the links and junctions where they occurred. Junctions and links exceeding an accident rate of one accident per year will be investigated further. A comparison to the predicted COBA rate will be undertaken to ascertain if the observed rate is in excess of the predicted accident rate. All personal injury accidents involving a vulnerable road user will be investigated regardless of the total

accident rate on the link/junction where they occurred. A summary table will be generated displaying the number of accidents and casualties and their severities for ease of understanding. In addition, the accidents will be displayed on a local road network map detailing their severity and type to clearly display any accident clusters. Potential solutions to clusters of accidents will be discussed.

Measures to Influence Travel / Public Transport, Walking and Cycling

The following non-car modes will be considered:

- Pedestrian routes around the site, to the local school and the development centre;
- Cycle routes;
- Bus service provision; and,
- Rail services.

Particular consideration will be given to access to Bicester which is the closest large settlement and is likely to provide many key services including secondary education.

Travel Plan

The Transport Assessment will contain an outline Travel Plan comprising the following sections:

- Process required to develop a TP
- Involvement of Site Occupiers
- Key Players
- Objectives, Targets and Monitoring
- Travel Plan Measures

Construction Issues

Issues that may arise during the construction stage will be considered in the Transport Assessment including access routes for contractors vehicles, parking, on-site traffic and pedestrian movement and construction/demolition waste processing.



CHERWELL DISTRICT

CHERWELL
Stoke Wood

Middleton
Stoney

Weston-
on-the-Green

Deddington

North
Aston

Steeple
Aston

Heyford

Northbrook

Kirtlington

Blotchingdon

Fritwell

Middleton
Stoney

Weston-
on-the-Green

Appendix B

Census Data

Work trips to Heyford

| To zone | Total | Car driver | Car passenger | Taxi | Train | Bus | Motorcycle | Bicycle | Foot | Works from home | Underground | Other |
|--|------------|------------|---------------|----------|----------|-----------|------------|-----------|-----------|-----------------|-------------|----------|
| Internal | 172 | 76 | 7 | 0 | 0 | 0 | 0 | 9 | 26 | 54 | 0 | 0 |
| Rest of The Astons and Heyfords | 40 | 37 | 0 | 0 | 0 | 0 | 0 | 3 | 0 | 0 | 0 | 0 |
| Adderbury-Cherwell | 3 | 3 | 0 | 0 | 0 | 0 | 0 | 0 | 0 | 0 | 0 | 0 |
| Ambrosden and Chesterton-Cherwell | 6 | 3 | 0 | 0 | 0 | 0 | 0 | 0 | 3 | 0 | 0 | 0 |
| Banbury Calthorpe-Cherwell | 22 | 22 | 0 | 0 | 0 | 0 | 0 | 0 | 0 | 0 | 0 | 0 |
| Banbury Easington-Cherwell | 9 | 9 | 0 | 0 | 0 | 0 | 0 | 0 | 0 | 0 | 0 | 0 |
| Banbury Grimsbury and Castle-Cherwell | 27 | 27 | 0 | 0 | 0 | 0 | 0 | 0 | 0 | 0 | 0 | 0 |
| Banbury Hardwick-Cherwell | 13 | 10 | 3 | 0 | 0 | 0 | 0 | 0 | 0 | 0 | 0 | 0 |
| Banbury Neithrop-Cherwell | 6 | 6 | 0 | 0 | 0 | 0 | 0 | 0 | 0 | 0 | 0 | 0 |
| Banbury Ruscote-Cherwell | 6 | 6 | 0 | 0 | 0 | 0 | 0 | 0 | 0 | 0 | 0 | 0 |
| Bicester East-Cherwell | 25 | 16 | 6 | 0 | 0 | 0 | 3 | 0 | 0 | 0 | 0 | 0 |
| Bicester North-Cherwell | 39 | 30 | 9 | 0 | 0 | 0 | 0 | 0 | 0 | 0 | 0 | 0 |
| Bicester South-Cherwell | 15 | 9 | 3 | 0 | 0 | 0 | 3 | 0 | 0 | 0 | 0 | 0 |
| Bicester Town-Cherwell | 33 | 21 | 12 | 0 | 0 | 0 | 0 | 0 | 0 | 0 | 0 | 0 |
| Bicester West-Cherwell | 24 | 18 | 3 | 0 | 0 | 3 | 0 | 0 | 0 | 0 | 0 | 0 |
| Bloxham and Bodicote-Cherwell | 21 | 18 | 0 | 0 | 0 | 3 | 0 | 0 | 0 | 0 | 0 | 0 |
| Caversfield-Cherwell | 7 | 7 | 0 | 0 | 0 | 0 | 0 | 0 | 0 | 0 | 0 | 0 |
| Deddington-Cherwell | 4 | 4 | 0 | 0 | 0 | 0 | 0 | 0 | 0 | 0 | 0 | 0 |
| Fringford-Cherwell | 9 | 6 | 0 | 0 | 0 | 3 | 0 | 0 | 0 | 0 | 0 | 0 |
| Hook Norton-Cherwell | 6 | 6 | 0 | 0 | 0 | 0 | 0 | 0 | 0 | 0 | 0 | 0 |
| Kidlington North-Cherwell | 3 | 3 | 0 | 0 | 0 | 0 | 0 | 0 | 0 | 0 | 0 | 0 |
| Kidlington South-Cherwell | 6 | 6 | 0 | 0 | 0 | 0 | 0 | 0 | 0 | 0 | 0 | 0 |
| Kirtlington-Cherwell | 12 | 6 | 6 | 0 | 0 | 0 | 0 | 0 | 0 | 0 | 0 | 0 |
| Launton-Cherwell | 6 | 6 | 0 | 0 | 0 | 0 | 0 | 0 | 0 | 0 | 0 | 0 |
| Otmoor-Cherwell | 3 | 3 | 0 | 0 | 0 | 0 | 0 | 0 | 0 | 0 | 0 | 0 |
| Wroxton-Cherwell | 6 | 6 | 0 | 0 | 0 | 0 | 0 | 0 | 0 | 0 | 0 | 0 |
| Brize Norton and Shilton-West Oxfordshire | 3 | 3 | 0 | 0 | 0 | 0 | 0 | 0 | 0 | 0 | 0 | 0 |
| Carterton North West-West Oxfordshire | 3 | 3 | 0 | 0 | 0 | 0 | 0 | 0 | 0 | 0 | 0 | 0 |
| Carterton South-West Oxfordshire | 3 | 3 | 0 | 0 | 0 | 0 | 0 | 0 | 0 | 0 | 0 | 0 |
| Chadlington and Churchill-West Oxfordshire | 3 | 3 | 0 | 0 | 0 | 0 | 0 | 0 | 0 | 0 | 0 | 0 |
| Charlbury and Finstock-West Oxfordshire | 9 | 9 | 0 | 0 | 0 | 0 | 0 | 0 | 0 | 0 | 0 | 0 |
| Chipping Norton-West Oxfordshire | 3 | 3 | 0 | 0 | 0 | 0 | 0 | 0 | 0 | 0 | 0 | 0 |
| Hailey, Minster Lovell and Leafield-West Oxfordshire | 3 | 3 | 0 | 0 | 0 | 0 | 0 | 0 | 0 | 0 | 0 | 0 |
| North Leigh-West Oxfordshire | 3 | 3 | 0 | 0 | 0 | 0 | 0 | 0 | 0 | 0 | 0 | 0 |
| Stonesfield and Tackley-West Oxfordshire | 6 | 6 | 0 | 0 | 0 | 0 | 0 | 0 | 0 | 0 | 0 | 0 |
| The Bartons-West Oxfordshire | 15 | 15 | 0 | 0 | 0 | 0 | 0 | 0 | 0 | 0 | 0 | 0 |
| Woodstock and Bladon-West Oxfordshire | 9 | 6 | 0 | 0 | 0 | 0 | 3 | 0 | 0 | 0 | 0 | 0 |
| Bedgrove-Aylesbury Vale | 3 | 3 | 0 | 0 | 0 | 0 | 0 | 0 | 0 | 0 | 0 | 0 |
| Brill-Aylesbury Vale | 6 | 6 | 0 | 0 | 0 | 0 | 0 | 0 | 0 | 0 | 0 | 0 |
| Buckingham North-Aylesbury Vale | 12 | 9 | 3 | 0 | 0 | 0 | 0 | 0 | 0 | 0 | 0 | 0 |
| Grendon Underwood-Aylesbury Vale | 6 | 6 | 0 | 0 | 0 | 0 | 0 | 0 | 0 | 0 | 0 | 0 |
| Marsh Gibbon-Aylesbury Vale | 6 | 6 | 0 | 0 | 0 | 0 | 0 | 0 | 0 | 0 | 0 | 0 |
| Pitstone-Aylesbury Vale | 3 | 3 | 0 | 0 | 0 | 0 | 0 | 0 | 0 | 0 | 0 | 0 |
| Quarrendon-Aylesbury Vale | 3 | 3 | 0 | 0 | 0 | 0 | 0 | 0 | 0 | 0 | 0 | 0 |
| Steeple Claydon-Aylesbury Vale | 6 | 3 | 0 | 0 | 0 | 3 | 0 | 0 | 0 | 0 | 0 | 0 |
| Walton Court and Hawkslade-Aylesbury Vale | 6 | 3 | 3 | 0 | 0 | 0 | 0 | 0 | 0 | 0 | 0 | 0 |
| Astell-South Northamptonshire | 3 | 3 | 0 | 0 | 0 | 0 | 0 | 0 | 0 | 0 | 0 | 0 |
| Brackley East-South Northamptonshire | 12 | 12 | 0 | 0 | 0 | 0 | 0 | 0 | 0 | 0 | 0 | 0 |
| Brackley South-South Northamptonshire | 19 | 19 | 0 | 0 | 0 | 0 | 0 | 0 | 0 | 0 | 0 | 0 |
| Brackley West-South Northamptonshire | 30 | 30 | 0 | 0 | 0 | 0 | 0 | 0 | 0 | 0 | 0 | 0 |
| Deanshanger-South Northamptonshire | 3 | 3 | 0 | 0 | 0 | 0 | 0 | 0 | 0 | 0 | 0 | 0 |
| Kings Sutton-South Northamptonshire | 9 | 9 | 0 | 0 | 0 | 0 | 0 | 0 | 0 | 0 | 0 | 0 |
| Little Brook-South Northamptonshire | 12 | 9 | 3 | 0 | 0 | 0 | 0 | 0 | 0 | 0 | 0 | 0 |
| Middleton Cheney-South Northamptonshire | 9 | 9 | 0 | 0 | 0 | 0 | 0 | 0 | 0 | 0 | 0 | 0 |
| Silverstone-South Northamptonshire | 3 | 3 | 0 | 0 | 0 | 0 | 0 | 0 | 0 | 0 | 0 | 0 |
| Steane-South Northamptonshire | 6 | 6 | 0 | 0 | 0 | 0 | 0 | 0 | 0 | 0 | 0 | 0 |
| Wardoun-South Northamptonshire | 6 | 6 | 0 | 0 | 0 | 0 | 0 | 0 | 0 | 0 | 0 | 0 |
| Rest of Northants | 21 | 21 | 0 | 0 | 0 | 0 | 0 | 0 | 0 | 0 | 0 | 0 |
| Oxford | 27 | 18 | 3 | 0 | 0 | 6 | 0 | 0 | 0 | 0 | 0 | 0 |
| South Oxfordshire | 24 | 18 | 3 | 0 | 0 | 3 | 0 | 0 | 0 | 0 | 0 | 0 |
| Vale of White Horse | 18 | 18 | 0 | 0 | 0 | 0 | 0 | 0 | 0 | 0 | 0 | 0 |
| Wycombe | 6 | 6 | 0 | 0 | 0 | 0 | 0 | 0 | 0 | 0 | 0 | 0 |
| Milton Keynes | 3 | 0 | 0 | 0 | 0 | 0 | 3 | 0 | 0 | 0 | 0 | 0 |
| Berkshire | 15 | 15 | 0 | 0 | 0 | 0 | 0 | 0 | 0 | 0 | 0 | 0 |
| Rest of South East | 3 | 3 | 0 | 0 | 0 | 0 | 0 | 0 | 0 | 0 | 0 | 0 |
| London | 6 | 6 | 0 | 0 | 0 | 0 | 0 | 0 | 0 | 0 | 0 | 0 |
| East | 12 | 12 | 0 | 0 | 0 | 0 | 0 | 0 | 0 | 0 | 0 | 0 |
| South West | 9 | 9 | 0 | 0 | 0 | 0 | 0 | 0 | 0 | 0 | 0 | 0 |
| West Midlands | 42 | 36 | 3 | 0 | 0 | 0 | 3 | 0 | 0 | 0 | 0 | 0 |
| North West | 6 | 6 | 0 | 0 | 0 | 0 | 0 | 0 | 0 | 0 | 0 | 0 |
| East Midlands | 15 | 15 | 0 | 0 | 0 | 0 | 0 | 0 | 0 | 0 | 0 | 0 |
| Yorkshire and Humber | 18 | 15 | 0 | 0 | 0 | 0 | 0 | 0 | 0 | 0 | 0 | 3 |
| North East | 3 | 3 | 0 | 0 | 0 | 0 | 0 | 0 | 0 | 0 | 0 | 0 |
| Wales | 6 | 6 | 0 | 0 | 0 | 0 | 0 | 0 | 0 | 0 | 0 | 0 |
| Total | 980 | 779 | 67 | 0 | 0 | 21 | 15 | 12 | 29 | 54 | 0 | 3 |

% of work trips to Heyford

| To zone | Total | Car driver | Car passenger | Taxi | Train | Bus | Motorcycle | Bicycle | Foot | Works from home | Underground | Other |
|--|-------------|-------------|---------------|-------------|-------------|-------------|-------------|-------------|-------------|-----------------|-------------|-------------|
| Internal | 18% | 10% | 10% | 0% | 0% | 0% | 0% | 75% | 90% | 100% | 0% | 0% |
| Rest of The Astons and Heyfords | 4% | 5% | 0% | 0% | 0% | 0% | 0% | 25% | 0% | 0% | 0% | 0% |
| Adderbury-Cherwell | 0% | 0% | 0% | 0% | 0% | 0% | 0% | 0% | 0% | 0% | 0% | 0% |
| Ambrosden and Chesterton-Cherwell | 1% | 0% | 0% | 0% | 0% | 0% | 0% | 0% | 10% | 0% | 0% | 0% |
| Banbury Calthorpe-Cherwell | 2% | 3% | 0% | 0% | 0% | 0% | 0% | 0% | 0% | 0% | 0% | 0% |
| Banbury Easington-Cherwell | 1% | 1% | 0% | 0% | 0% | 0% | 0% | 0% | 0% | 0% | 0% | 0% |
| Banbury Grimsbury and Castle-Cherwell | 3% | 3% | 0% | 0% | 0% | 0% | 0% | 0% | 0% | 0% | 0% | 0% |
| Banbury Hardwick-Cherwell | 1% | 1% | 4% | 0% | 0% | 0% | 0% | 0% | 0% | 0% | 0% | 0% |
| Banbury Neithrop-Cherwell | 1% | 1% | 0% | 0% | 0% | 0% | 0% | 0% | 0% | 0% | 0% | 0% |
| Banbury Ruscote-Cherwell | 1% | 1% | 0% | 0% | 0% | 0% | 0% | 0% | 0% | 0% | 0% | 0% |
| Bicester East-Cherwell | 3% | 2% | 9% | 0% | 0% | 0% | 20% | 0% | 0% | 0% | 0% | 0% |
| Bicester North-Cherwell | 4% | 4% | 13% | 0% | 0% | 0% | 0% | 0% | 0% | 0% | 0% | 0% |
| Bicester South-Cherwell | 2% | 1% | 4% | 0% | 0% | 0% | 20% | 0% | 0% | 0% | 0% | 0% |
| Bicester Town-Cherwell | 3% | 3% | 18% | 0% | 0% | 0% | 0% | 0% | 0% | 0% | 0% | 0% |
| Bicester West-Cherwell | 2% | 2% | 4% | 0% | 0% | 14% | 0% | 0% | 0% | 0% | 0% | 0% |
| Bloxham and Bodicote-Cherwell | 2% | 2% | 0% | 0% | 0% | 14% | 0% | 0% | 0% | 0% | 0% | 0% |
| Caversfield-Cherwell | 1% | 1% | 0% | 0% | 0% | 0% | 0% | 0% | 0% | 0% | 0% | 0% |
| Deddington-Cherwell | 0% | 1% | 0% | 0% | 0% | 0% | 0% | 0% | 0% | 0% | 0% | 0% |
| Fringford-Cherwell | 1% | 1% | 0% | 0% | 0% | 14% | 0% | 0% | 0% | 0% | 0% | 0% |
| Hook Norton-Cherwell | 1% | 1% | 0% | 0% | 0% | 0% | 0% | 0% | 0% | 0% | 0% | 0% |
| Kidlington North-Cherwell | 0% | 0% | 0% | 0% | 0% | 0% | 0% | 0% | 0% | 0% | 0% | 0% |
| Kidlington South-Cherwell | 1% | 1% | 0% | 0% | 0% | 0% | 0% | 0% | 0% | 0% | 0% | 0% |
| Kirtlington-Cherwell | 1% | 1% | 9% | 0% | 0% | 0% | 0% | 0% | 0% | 0% | 0% | 0% |
| Launton-Cherwell | 1% | 1% | 0% | 0% | 0% | 0% | 0% | 0% | 0% | 0% | 0% | 0% |
| Otmoor-Cherwell | 0% | 0% | 0% | 0% | 0% | 0% | 0% | 0% | 0% | 0% | 0% | 0% |
| Wroxton-Cherwell | 1% | 1% | 0% | 0% | 0% | 0% | 0% | 0% | 0% | 0% | 0% | 0% |
| Brize Norton and Shilton-West Oxfordshire | 0% | 0% | 0% | 0% | 0% | 0% | 0% | 0% | 0% | 0% | 0% | 0% |
| Carterton North West-West Oxfordshire | 0% | 0% | 0% | 0% | 0% | 0% | 0% | 0% | 0% | 0% | 0% | 0% |
| Carterton South-West Oxfordshire | 0% | 0% | 0% | 0% | 0% | 0% | 0% | 0% | 0% | 0% | 0% | 0% |
| Chadlington and Churchill-West Oxfordshire | 0% | 0% | 0% | 0% | 0% | 0% | 0% | 0% | 0% | 0% | 0% | 0% |
| Charlbury and Finstock-West Oxfordshire | 1% | 1% | 0% | 0% | 0% | 0% | 0% | 0% | 0% | 0% | 0% | 0% |
| Chipping Norton-West Oxfordshire | 0% | 0% | 0% | 0% | 0% | 0% | 0% | 0% | 0% | 0% | 0% | 0% |
| Hailey, Minster Lovell and Leafield-West Oxfordshire | 0% | 0% | 0% | 0% | 0% | 0% | 0% | 0% | 0% | 0% | 0% | 0% |
| North Leigh-West Oxfordshire | 0% | 0% | 0% | 0% | 0% | 0% | 0% | 0% | 0% | 0% | 0% | 0% |
| Stonesfield and Tackley-West Oxfordshire | 1% | 1% | 0% | 0% | 0% | 0% | 0% | 0% | 0% | 0% | 0% | 0% |
| The Bartons-West Oxfordshire | 2% | 2% | 0% | 0% | 0% | 0% | 0% | 0% | 0% | 0% | 0% | 0% |
| Woodstock and Bladon-West Oxfordshire | 1% | 1% | 0% | 0% | 0% | 0% | 20% | 0% | 0% | 0% | 0% | 0% |
| Bedgrove-Aylesbury Vale | 0% | 0% | 0% | 0% | 0% | 0% | 0% | 0% | 0% | 0% | 0% | 0% |
| Brill-Aylesbury Vale | 1% | 1% | 0% | 0% | 0% | 0% | 0% | 0% | 0% | 0% | 0% | 0% |
| Buckingham North-Aylesbury Vale | 1% | 1% | 4% | 0% | 0% | 0% | 0% | 0% | 0% | 0% | 0% | 0% |
| Grendon Underwood-Aylesbury Vale | 1% | 1% | 0% | 0% | 0% | 0% | 0% | 0% | 0% | 0% | 0% | 0% |
| Marsh Gibbon-Aylesbury Vale | 1% | 1% | 0% | 0% | 0% | 0% | 0% | 0% | 0% | 0% | 0% | 0% |
| Pitstone-Aylesbury Vale | 0% | 0% | 0% | 0% | 0% | 0% | 0% | 0% | 0% | 0% | 0% | 0% |
| Quarrendon-Aylesbury Vale | 0% | 0% | 0% | 0% | 0% | 0% | 0% | 0% | 0% | 0% | 0% | 0% |
| Steeple Claydon-Aylesbury Vale | 1% | 0% | 0% | 0% | 0% | 14% | 0% | 0% | 0% | 0% | 0% | 0% |
| Walton Court and Hawkslade-Aylesbury Vale | 1% | 0% | 4% | 0% | 0% | 0% | 0% | 0% | 0% | 0% | 0% | 0% |
| Astwell-South Northamptonshire | 0% | 0% | 0% | 0% | 0% | 0% | 0% | 0% | 0% | 0% | 0% | 0% |
| Brackley East-South Northamptonshire | 1% | 2% | 0% | 0% | 0% | 0% | 0% | 0% | 0% | 0% | 0% | 0% |
| Brackley South-South Northamptonshire | 2% | 2% | 0% | 0% | 0% | 0% | 0% | 0% | 0% | 0% | 0% | 0% |
| Brackley West-South Northamptonshire | 3% | 4% | 0% | 0% | 0% | 0% | 0% | 0% | 0% | 0% | 0% | 0% |
| Deanshanger-South Northamptonshire | 0% | 0% | 0% | 0% | 0% | 0% | 0% | 0% | 0% | 0% | 0% | 0% |
| Kings Sutton-South Northamptonshire | 1% | 1% | 0% | 0% | 0% | 0% | 0% | 0% | 0% | 0% | 0% | 0% |
| Little Brook-South Northamptonshire | 1% | 1% | 4% | 0% | 0% | 0% | 0% | 0% | 0% | 0% | 0% | 0% |
| Middleton Cheney-South Northamptonshire | 1% | 1% | 0% | 0% | 0% | 0% | 0% | 0% | 0% | 0% | 0% | 0% |
| Silverstone-South Northamptonshire | 0% | 0% | 0% | 0% | 0% | 0% | 0% | 0% | 0% | 0% | 0% | 0% |
| Steane-South Northamptonshire | 1% | 1% | 0% | 0% | 0% | 0% | 0% | 0% | 0% | 0% | 0% | 0% |
| Wardoun-South Northamptonshire | 1% | 1% | 0% | 0% | 0% | 0% | 0% | 0% | 0% | 0% | 0% | 0% |
| Rest of Northants | 2% | 3% | 0% | 0% | 0% | 0% | 0% | 0% | 0% | 0% | 0% | 0% |
| Oxford | 3% | 2% | 4% | 0% | 0% | 29% | 0% | 0% | 0% | 0% | 0% | 0% |
| South Oxfordshire | 2% | 2% | 4% | 0% | 0% | 14% | 0% | 0% | 0% | 0% | 0% | 0% |
| Vale of White Horse | 2% | 2% | 0% | 0% | 0% | 0% | 0% | 0% | 0% | 0% | 0% | 0% |
| Wycombe | 1% | 1% | 0% | 0% | 0% | 0% | 0% | 0% | 0% | 0% | 0% | 0% |
| Milton Keynes | 0% | 0% | 0% | 0% | 0% | 0% | 20% | 0% | 0% | 0% | 0% | 0% |
| Berkshire | 2% | 2% | 0% | 0% | 0% | 0% | 0% | 0% | 0% | 0% | 0% | 0% |
| Rest of South East | 0% | 0% | 0% | 0% | 0% | 0% | 0% | 0% | 0% | 0% | 0% | 0% |
| London | 1% | 1% | 0% | 0% | 0% | 0% | 0% | 0% | 0% | 0% | 0% | 0% |
| East | 1% | 2% | 0% | 0% | 0% | 0% | 0% | 0% | 0% | 0% | 0% | 0% |
| South West | 1% | 1% | 0% | 0% | 0% | 0% | 0% | 0% | 0% | 0% | 0% | 0% |
| West Midlands | 4% | 5% | 4% | 0% | 0% | 0% | 20% | 0% | 0% | 0% | 0% | 0% |
| North West | 1% | 1% | 0% | 0% | 0% | 0% | 0% | 0% | 0% | 0% | 0% | 0% |
| East Midlands | 2% | 2% | 0% | 0% | 0% | 0% | 0% | 0% | 0% | 0% | 0% | 0% |
| Yorkshire and Humber | 2% | 2% | 0% | 0% | 0% | 0% | 0% | 0% | 0% | 0% | 0% | 100% |
| North East | 0% | 0% | 0% | 0% | 0% | 0% | 0% | 0% | 0% | 0% | 0% | 0% |
| Wales | 1% | 1% | 0% | 0% | 0% | 0% | 0% | 0% | 0% | 0% | 0% | 0% |
| Total | 100% | 100% | 100% | 100% | 100% | 100% | 100% | 100% | 100% | 100% | 100% | 100% |

Work trips from Heyford

| From zone | Total | Car driver | Car passenger | Taxi | Train | Bus | Motorcycle | Bicycle | Foot | Works from home | Underground | Other |
|---|------------|------------|---------------|----------|-----------|-----------|------------|-----------|-----------|-----------------|-------------|----------|
| Internal | 172 | 76 | 7 | 0 | 0 | 0 | 0 | 9 | 26 | 54 | 0 | 0 |
| Rest of The Astons and Heyfords | 9 | 6 | 0 | 0 | 0 | 0 | 0 | 0 | 3 | 0 | 0 | 0 |
| Adderbury-Cherwell | 6 | 6 | 0 | 0 | 0 | 0 | 0 | 0 | 0 | 0 | 0 | 0 |
| Ambrosden and Chesterton-Cherwell | 21 | 18 | 0 | 0 | 0 | 3 | 0 | 0 | 0 | 0 | 0 | 0 |
| Banbury Calthorpe-Cherwell | | | | | | | | | | | | |
| Banbury Easington-Cherwell | 3 | 3 | 0 | 0 | 0 | 0 | 0 | 0 | 0 | 0 | 0 | 0 |
| Banbury Grimsbury and Castle-Cherwell | 21 | 18 | 0 | 0 | 0 | 0 | 0 | 0 | 3 | 0 | 0 | 0 |
| Banbury Neithrop-Cherwell | 3 | 3 | 0 | 0 | 0 | 0 | 0 | 0 | 0 | 0 | 0 | 0 |
| Bicester East-Cherwell | 53 | 43 | 7 | 0 | 0 | 0 | 0 | 3 | 0 | 0 | 0 | 0 |
| Bicester North-Cherwell | | | | | | | | | | | | |
| Bicester South-Cherwell | 6 | 6 | 0 | 0 | 0 | 0 | 0 | 0 | 0 | 0 | 0 | 0 |
| Bicester Town-Cherwell | 62 | 47 | 3 | 0 | 0 | 12 | 0 | 0 | 0 | 0 | 0 | 0 |
| Bicester West-Cherwell | 6 | 3 | 0 | 0 | 0 | 0 | 0 | 0 | 3 | 0 | 0 | 0 |
| Bloxham and Bodicote-Cherwell | 6 | 6 | 0 | 0 | 0 | 0 | 0 | 0 | 0 | 0 | 0 | 0 |
| Caversfield-Cherwell | 27 | 15 | 3 | 3 | 0 | 6 | 0 | 0 | 0 | 0 | 0 | 0 |
| Cropredy-Cherwell | | | | | | | | | | | | |
| Deddington-Cherwell | 15 | 15 | 0 | 0 | 0 | 0 | 0 | 0 | 0 | 0 | 0 | 0 |
| Fringford-Cherwell | 6 | 6 | 0 | 0 | 0 | 0 | 0 | 0 | 0 | 0 | 0 | 0 |
| Hook Norton-Cherwell | 3 | 3 | 0 | 0 | 0 | 0 | 0 | 0 | 0 | 0 | 0 | 0 |
| Kidlington North-Cherwell | 21 | 21 | 0 | 0 | 0 | 0 | 0 | 0 | 0 | 0 | 0 | 0 |
| Kidlington South-Cherwell | 3 | 3 | 0 | 0 | 0 | 0 | 0 | 0 | 0 | 0 | 0 | 0 |
| Kirtlington-Cherwell | 13 | 13 | 0 | 0 | 0 | 0 | 0 | 0 | 0 | 0 | 0 | 0 |
| Launton-Cherwell | 25 | 10 | 6 | 0 | 0 | 6 | 0 | 3 | 0 | 0 | 0 | 0 |
| Otmoor-Cherwell | | | | | | | | | | | | |
| Sibford-Cherwell | 3 | 3 | 0 | 0 | 0 | 0 | 0 | 0 | 0 | 0 | 0 | 0 |
| Wroxton-Cherwell | | | | | | | | | | | | |
| Yarnton, Gosford and Water Eaton-Cherwell | 6 | 6 | 0 | 0 | 0 | 0 | 0 | 0 | 0 | 0 | 0 | 0 |
| Brize Norton and Shilton-West Oxon | | | | | | | | | | | | |
| Carterton North West-West Oxon | | | | | | | | | | | | |
| Chadlington and Churchill-West Oxon | | | | | | | | | | | | |
| Chipping Norton-West Oxon | 6 | 3 | 0 | 0 | 0 | 0 | 0 | 0 | 3 | 0 | 0 | 0 |
| Eynsham and Cassington-West Oxon | 3 | 3 | 0 | 0 | 0 | 0 | 0 | 0 | 0 | 0 | 0 | 0 |
| Freeland and Hanborough-West Oxon | | | | | | | | | | | | |
| Hailey, Minster Lovell and Leafield-West Oxon | | | | | | | | | | | | |
| Kingham, Rollright and Enstone-West Oxon | 6 | 3 | 0 | 0 | 0 | 0 | 3 | 0 | 0 | 0 | 0 | 0 |
| Standlake, Aston and Stanton Harcourt-West Oxon | 3 | 3 | 0 | 0 | 0 | 0 | 0 | 0 | 0 | 0 | 0 | 0 |
| Stonesfield and Tackley-West Oxon | | | | | | | | | | | | |
| Witney East-West Oxon | | | | | | | | | | | | |
| Witney South-West Oxon | 3 | 0 | 3 | 0 | 0 | 0 | 0 | 0 | 0 | 0 | 0 | 0 |
| Woodstock and Bladon-West Oxon | 3 | 0 | 0 | 3 | 0 | 0 | 0 | 0 | 0 | 0 | 0 | 0 |
| Aston Clinton-Aylesbury Vale | | | | | | | | | | | | |
| Aylesbury Central-Aylesbury Vale | | | | | | | | | | | | |
| Bedgrove-Aylesbury Vale | | | | | | | | | | | | |
| Brill-Aylesbury Vale | | | | | | | | | | | | |
| Buckingham North-Aylesbury Vale | 3 | 3 | 0 | 0 | 0 | 0 | 0 | 0 | 0 | 0 | 0 | 0 |
| Buckingham South-Aylesbury Vale | | | | | | | | | | | | |
| Cheddington-Aylesbury Vale | | | | | | | | | | | | |
| Coldharbour-Aylesbury Vale | | | | | | | | | | | | |
| Elmhurst and Watermead-Aylesbury Vale | | | | | | | | | | | | |
| Gatehouse-Aylesbury Vale | | | | | | | | | | | | |
| Grendon Underwood-Aylesbury Vale | 3 | 3 | 0 | 0 | 0 | 0 | 0 | 0 | 0 | 0 | 0 | 0 |
| Haddenham-Aylesbury Vale | | | | | | | | | | | | |
| Long Crendon-Aylesbury Vale | | | | | | | | | | | | |
| Luffield Abbey-Aylesbury Vale | | | | | | | | | | | | |
| Mandeville and Elm Farm-Aylesbury Vale | | | | | | | | | | | | |
| Marsh Gibbon-Aylesbury Vale | 3 | 3 | 0 | 0 | 0 | 0 | 0 | 0 | 0 | 0 | 0 | 0 |
| Oakfield-Aylesbury Vale | | | | | | | | | | | | |
| Quarrendon-Aylesbury Vale | 3 | 3 | 0 | 0 | 0 | 0 | 0 | 0 | 0 | 0 | 0 | 0 |
| Southcourt-Aylesbury Vale | 3 | 3 | 0 | 0 | 0 | 0 | 0 | 0 | 0 | 0 | 0 | 0 |
| Waddesdon-Aylesbury Vale | | | | | | | | | | | | |
| Wendover-Aylesbury Vale | 3 | 3 | 0 | 0 | 0 | 0 | 0 | 0 | 0 | 0 | 0 | 0 |
| Brackley East-South Northants | 3 | 3 | 0 | 0 | 0 | 0 | 0 | 0 | 0 | 0 | 0 | 0 |
| Cosgrove-South Northants | | | | | | | | | | | | |
| Little Brook-South Northants | 23 | 23 | 0 | 0 | 0 | 0 | 0 | 0 | 0 | 0 | 0 | 0 |
| Middleton Cheney-South Northants | | | | | | | | | | | | |
| Silverstone-South Northants | | | | | | | | | | | | |
| Steane-South Northants | | | | | | | | | | | | |
| Towcester Brook-South Northants | | | | | | | | | | | | |
| Rest of Northants | | | | | | | | | | | | |
| Oxford | 72 | 39 | 12 | 0 | 6 | 15 | 0 | 0 | 0 | 0 | 0 | 0 |
| South Oxfordshire | 15 | 15 | 0 | 0 | 0 | 0 | 0 | 0 | 0 | 0 | 0 | 0 |
| Vale of White Horse | 21 | 21 | 0 | 0 | 0 | 0 | 0 | 0 | 0 | 0 | 0 | 0 |
| Chiltern | | | | | | | | | | | | |
| South Bucks | | | | | | | | | | | | |
| Wycombe | 3 | 3 | 0 | 0 | 0 | 0 | 0 | 0 | 0 | 0 | 0 | 0 |
| Milton Keynes | 9 | 9 | 0 | 0 | 0 | 0 | 0 | 0 | 0 | 0 | 0 | 0 |
| Berkshire | 3 | 3 | 0 | 0 | 0 | 0 | 0 | 0 | 0 | 0 | 0 | 0 |
| Rest of South East | 9 | 9 | 0 | 0 | 0 | 0 | 0 | 0 | 0 | 0 | 0 | 0 |
| London | 24 | 15 | 0 | 0 | 9 | 0 | 0 | 0 | 0 | 0 | 0 | 0 |
| East | 9 | 9 | 0 | 0 | 0 | 0 | 0 | 0 | 0 | 0 | 0 | 0 |
| South West | 9 | 9 | 0 | 0 | 0 | 0 | 0 | 0 | 0 | 0 | 0 | 0 |
| West Midlands | 15 | 12 | 3 | 0 | 0 | 0 | 0 | 0 | 0 | 0 | 0 | 0 |
| East Midlands | | | | | | | | | | | | |
| North West | 3 | 3 | 0 | 0 | 0 | 0 | 0 | 0 | 0 | 0 | 0 | 0 |
| Yorkshire and Humber | 3 | 3 | 0 | 0 | 0 | 0 | 0 | 0 | 0 | 0 | 0 | 0 |
| Offshore | | | | | | | | | | | | |
| Total | 753 | 536 | 44 | 6 | 15 | 42 | 3 | 15 | 38 | 54 | 0 | 0 |

% of work trips from Heyford

| From zone | Total | Car driver | Car passenger | Taxi | Train | Bus | Motorcycle | Bicycle | Foot | Works from home | Underground | Other |
|---|-------------|-------------|---------------|-------------|-------------|-------------|-------------|-------------|-------------|-----------------|-------------|-------------|
| Internal | 23% | 14% | 16% | 0% | 0% | 0% | 0% | 60% | 68% | 100% | 0% | 0% |
| The Astons and Heyfords-Cherwell | 1% | 1% | 0% | 0% | 0% | 0% | 0% | 0% | 8% | 0% | 0% | 0% |
| Adderbury-Cherwell | 1% | 1% | 0% | 0% | 0% | 0% | 0% | 0% | 0% | 0% | 0% | 0% |
| Ambrosden and Chesterton-Cherwell | 3% | 3% | 0% | 0% | 0% | 7% | 0% | 0% | 0% | 0% | 0% | 0% |
| Banbury Calthorpe-Cherwell | 0% | 0% | 0% | 0% | 0% | 0% | 0% | 0% | 0% | 0% | 0% | 0% |
| Banbury Easington-Cherwell | 0% | 1% | 0% | 0% | 0% | 0% | 0% | 0% | 0% | 0% | 0% | 0% |
| Banbury Grimsbury and Castle-Cherwell | 3% | 3% | 0% | 0% | 0% | 0% | 0% | 0% | 8% | 0% | 0% | 0% |
| Banbury Neithrop-Cherwell | 0% | 1% | 0% | 0% | 0% | 0% | 0% | 0% | 0% | 0% | 0% | 0% |
| Bicester East-Cherwell | 7% | 8% | 16% | 0% | 0% | 0% | 0% | 20% | 0% | 0% | 0% | 0% |
| Bicester North-Cherwell | 0% | 0% | 0% | 0% | 0% | 0% | 0% | 0% | 0% | 0% | 0% | 0% |
| Bicester South-Cherwell | 1% | 1% | 0% | 0% | 0% | 0% | 0% | 0% | 0% | 0% | 0% | 0% |
| Bicester Town-Cherwell | 8% | 9% | 7% | 0% | 0% | 29% | 0% | 0% | 0% | 0% | 0% | 0% |
| Bicester West-Cherwell | 1% | 1% | 0% | 0% | 0% | 0% | 0% | 0% | 8% | 0% | 0% | 0% |
| Bloxham and Bodicote-Cherwell | 1% | 1% | 0% | 0% | 0% | 0% | 0% | 0% | 0% | 0% | 0% | 0% |
| Caversfield-Cherwell | 4% | 3% | 7% | 50% | 0% | 14% | 0% | 0% | 0% | 0% | 0% | 0% |
| Cropredy-Cherwell | 0% | 0% | 0% | 0% | 0% | 0% | 0% | 0% | 0% | 0% | 0% | 0% |
| Deddington-Cherwell | 2% | 3% | 0% | 0% | 0% | 0% | 0% | 0% | 0% | 0% | 0% | 0% |
| Fringford-Cherwell | 1% | 1% | 0% | 0% | 0% | 0% | 0% | 0% | 0% | 0% | 0% | 0% |
| Hook Norton-Cherwell | 0% | 1% | 0% | 0% | 0% | 0% | 0% | 0% | 0% | 0% | 0% | 0% |
| Kidlington North-Cherwell | 3% | 4% | 0% | 0% | 0% | 0% | 0% | 0% | 0% | 0% | 0% | 0% |
| Kidlington South-Cherwell | 0% | 1% | 0% | 0% | 0% | 0% | 0% | 0% | 0% | 0% | 0% | 0% |
| Kirtlington-Cherwell | 2% | 2% | 0% | 0% | 0% | 0% | 0% | 0% | 0% | 0% | 0% | 0% |
| Launton-Cherwell | 3% | 2% | 14% | 0% | 0% | 14% | 0% | 20% | 0% | 0% | 0% | 0% |
| Otmoor-Cherwell | 0% | 0% | 0% | 0% | 0% | 0% | 0% | 0% | 0% | 0% | 0% | 0% |
| Sibford-Cherwell | 0% | 1% | 0% | 0% | 0% | 0% | 0% | 0% | 0% | 0% | 0% | 0% |
| Wroxton-Cherwell | 0% | 0% | 0% | 0% | 0% | 0% | 0% | 0% | 0% | 0% | 0% | 0% |
| Yarnton, Gosford and Water Eaton-Cherwell | 1% | 1% | 0% | 0% | 0% | 0% | 0% | 0% | 0% | 0% | 0% | 0% |
| Brize Norton and Shilton-West Oxon | 0% | 0% | 0% | 0% | 0% | 0% | 0% | 0% | 0% | 0% | 0% | 0% |
| Carterton North West-West Oxon | 0% | 0% | 0% | 0% | 0% | 0% | 0% | 0% | 0% | 0% | 0% | 0% |
| Chadlington and Churchill-West Oxon | 0% | 0% | 0% | 0% | 0% | 0% | 0% | 0% | 0% | 0% | 0% | 0% |
| Chipping Norton-West Oxon | 1% | 1% | 0% | 0% | 0% | 0% | 0% | 0% | 8% | 0% | 0% | 0% |
| Eynsham and Cassington-West Oxon | 0% | 1% | 0% | 0% | 0% | 0% | 0% | 0% | 0% | 0% | 0% | 0% |
| Freeland and Hanborough-West Oxon | 0% | 0% | 0% | 0% | 0% | 0% | 0% | 0% | 0% | 0% | 0% | 0% |
| Hailey, Minster Lovell and Leafield-West Oxon | 0% | 0% | 0% | 0% | 0% | 0% | 0% | 0% | 0% | 0% | 0% | 0% |
| Kingham, Rollright and Enstone-West Oxon | 1% | 1% | 0% | 0% | 0% | 0% | 100% | 0% | 0% | 0% | 0% | 0% |
| Standlake, Aston and Stanton Harcourt-West Oxon | 0% | 1% | 0% | 0% | 0% | 0% | 0% | 0% | 0% | 0% | 0% | 0% |
| Stonesfield and Tackley-West Oxon | 0% | 0% | 0% | 0% | 0% | 0% | 0% | 0% | 0% | 0% | 0% | 0% |
| Witney East-West Oxon | 0% | 0% | 0% | 0% | 0% | 0% | 0% | 0% | 0% | 0% | 0% | 0% |
| Witney South-West Oxon | 0% | 0% | 7% | 0% | 0% | 0% | 0% | 0% | 0% | 0% | 0% | 0% |
| Woodstock and Bladon-West Oxon | 0% | 0% | 0% | 50% | 0% | 0% | 0% | 0% | 0% | 0% | 0% | 0% |
| Aston Clinton-Aylesbury Vale | 0% | 0% | 0% | 0% | 0% | 0% | 0% | 0% | 0% | 0% | 0% | 0% |
| Aylesbury Central-Aylesbury Vale | 0% | 0% | 0% | 0% | 0% | 0% | 0% | 0% | 0% | 0% | 0% | 0% |
| Bedgrove-Aylesbury Vale | 0% | 0% | 0% | 0% | 0% | 0% | 0% | 0% | 0% | 0% | 0% | 0% |
| Brill-Aylesbury Vale | 0% | 0% | 0% | 0% | 0% | 0% | 0% | 0% | 0% | 0% | 0% | 0% |
| Buckingham North-Aylesbury Vale | 0% | 1% | 0% | 0% | 0% | 0% | 0% | 0% | 0% | 0% | 0% | 0% |
| Buckingham South-Aylesbury Vale | 0% | 0% | 0% | 0% | 0% | 0% | 0% | 0% | 0% | 0% | 0% | 0% |
| Cheddington-Aylesbury Vale | 0% | 0% | 0% | 0% | 0% | 0% | 0% | 0% | 0% | 0% | 0% | 0% |
| Coldharbour-Aylesbury Vale | 0% | 0% | 0% | 0% | 0% | 0% | 0% | 0% | 0% | 0% | 0% | 0% |
| Elmhurst and Watermead-Aylesbury Vale | 0% | 0% | 0% | 0% | 0% | 0% | 0% | 0% | 0% | 0% | 0% | 0% |
| Gatehouse-Aylesbury Vale | 0% | 0% | 0% | 0% | 0% | 0% | 0% | 0% | 0% | 0% | 0% | 0% |
| Grendon Underwood-Aylesbury Vale | 0% | 1% | 0% | 0% | 0% | 0% | 0% | 0% | 0% | 0% | 0% | 0% |
| Haddenham-Aylesbury Vale | 0% | 0% | 0% | 0% | 0% | 0% | 0% | 0% | 0% | 0% | 0% | 0% |
| Long Crendon-Aylesbury Vale | 0% | 0% | 0% | 0% | 0% | 0% | 0% | 0% | 0% | 0% | 0% | 0% |
| Luffield Abbey-Aylesbury Vale | 0% | 0% | 0% | 0% | 0% | 0% | 0% | 0% | 0% | 0% | 0% | 0% |
| Mandeville and Elm Farm-Aylesbury Vale | 0% | 0% | 0% | 0% | 0% | 0% | 0% | 0% | 0% | 0% | 0% | 0% |
| Marsh Gibbon-Aylesbury Vale | 0% | 1% | 0% | 0% | 0% | 0% | 0% | 0% | 0% | 0% | 0% | 0% |
| Oakfield-Aylesbury Vale | 0% | 0% | 0% | 0% | 0% | 0% | 0% | 0% | 0% | 0% | 0% | 0% |
| Quarrendon-Aylesbury Vale | 0% | 1% | 0% | 0% | 0% | 0% | 0% | 0% | 0% | 0% | 0% | 0% |
| Southcourt-Aylesbury Vale | 0% | 1% | 0% | 0% | 0% | 0% | 0% | 0% | 0% | 0% | 0% | 0% |
| Waddesdon-Aylesbury Vale | 0% | 0% | 0% | 0% | 0% | 0% | 0% | 0% | 0% | 0% | 0% | 0% |
| Wendover-Aylesbury Vale | 0% | 1% | 0% | 0% | 0% | 0% | 0% | 0% | 0% | 0% | 0% | 0% |
| Brackley East-South Northants | 0% | 1% | 0% | 0% | 0% | 0% | 0% | 0% | 0% | 0% | 0% | 0% |
| Cosgrove-South Northants | 0% | 0% | 0% | 0% | 0% | 0% | 0% | 0% | 0% | 0% | 0% | 0% |
| Little Brook-South Northants | 3% | 4% | 0% | 0% | 0% | 0% | 0% | 0% | 0% | 0% | 0% | 0% |
| Middleton Cheney-South Northants | 0% | 0% | 0% | 0% | 0% | 0% | 0% | 0% | 0% | 0% | 0% | 0% |
| Silverstone-South Northants | 0% | 0% | 0% | 0% | 0% | 0% | 0% | 0% | 0% | 0% | 0% | 0% |
| Steane-South Northants | 0% | 0% | 0% | 0% | 0% | 0% | 0% | 0% | 0% | 0% | 0% | 0% |
| Towcester Brook-South Northants | 0% | 0% | 0% | 0% | 0% | 0% | 0% | 0% | 0% | 0% | 0% | 0% |
| Rest of Northants | 0% | 0% | 0% | 0% | 0% | 0% | 0% | 0% | 0% | 0% | 0% | 0% |
| Oxford | 10% | 7% | 27% | 0% | 40% | 36% | 0% | 0% | 0% | 0% | 0% | 0% |
| South Oxfordshire | 2% | 3% | 0% | 0% | 0% | 0% | 0% | 0% | 0% | 0% | 0% | 0% |
| Vale of White Horse | 3% | 4% | 0% | 0% | 0% | 0% | 0% | 0% | 0% | 0% | 0% | 0% |
| Chiltern | 0% | 0% | 0% | 0% | 0% | 0% | 0% | 0% | 0% | 0% | 0% | 0% |
| South Bucks | 0% | 0% | 0% | 0% | 0% | 0% | 0% | 0% | 0% | 0% | 0% | 0% |
| Wycombe | 0% | 1% | 0% | 0% | 0% | 0% | 0% | 0% | 0% | 0% | 0% | 0% |
| Milton Keynes | 1% | 2% | 0% | 0% | 0% | 0% | 0% | 0% | 0% | 0% | 0% | 0% |
| Berkshire | 0% | 1% | 0% | 0% | 0% | 0% | 0% | 0% | 0% | 0% | 0% | 0% |
| Rest of South East | 1% | 2% | 0% | 0% | 0% | 0% | 0% | 0% | 0% | 0% | 0% | 0% |
| London | 3% | 3% | 0% | 0% | 60% | 0% | 0% | 0% | 0% | 0% | 0% | 0% |
| East | 1% | 2% | 0% | 0% | 0% | 0% | 0% | 0% | 0% | 0% | 0% | 0% |
| South West | 1% | 2% | 0% | 0% | 0% | 0% | 0% | 0% | 0% | 0% | 0% | 0% |
| West Midlands | 2% | 2% | 7% | 0% | 0% | 0% | 0% | 0% | 0% | 0% | 0% | 0% |
| East Midlands | 0% | 0% | 0% | 0% | 0% | 0% | 0% | 0% | 0% | 0% | 0% | 0% |
| North West | 0% | 1% | 0% | 0% | 0% | 0% | 0% | 0% | 0% | 0% | 0% | 0% |
| Yorkshire and Humber | 0% | 1% | 0% | 0% | 0% | 0% | 0% | 0% | 0% | 0% | 0% | 0% |
| Offshore | 0% | 0% | 0% | 0% | 0% | 0% | 0% | 0% | 0% | 0% | 0% | 0% |
| Total | 100% | 100% | 100% | 100% | 100% | 100% | 100% | 100% | 100% | 100% | 100% | 100% |

Appendix C

**Technical Note:
Methodology for
Applying Distribution**

| | | |
|-------------|--|-----------------|
| Job title | Heyford Park Transport Assessment | Job number |
| | | 120669 |
| cc | | File reference |
| | | 4-05-03 |
| Prepared by | Ian Clarke x 3 3675 (Arup Campus) | Date |
| | | 9 November 2006 |
| Subject | Methodology for applying distribution of trips to/from Heyford Park based on Census data | |

Methodology

Distribution calculated by using Journey to Work data for car drivers from the 2001 Census supplied by the government's Office for National Statistics.

Data was extracted at Ward level for Cherwell District (which includes Astons and The Heyfords Ward) and three other Districts adjoining Cherwell that contained a significant number of trips:

- Aylesbury Vale
- South Northamptonshire
- West Oxfordshire

Outside this area the data was disaggregated to District level, with Counties slightly further out and at Region level beyond this. In total 73% of all driver trips were within the area examined at the finest (Ward) level.

The junctions agreed for possible assessment are all located within the Astons and the Heyfords Ward. In order to calculate routes that passed through these junctions trips to/from Heyford Park itself were disaggregated from the Ward data by extracting data for the four Super Output Areas that cover Heyford Park (and Upper Heyford Village). See figure 'Heyford Park Super Output Areas'. These four areas are described below as the Heyford Park Super Output Area.

The number and percentages, disaggregated by mode, relating to the Heyford Park Super Output Area were obtained for:

- Trips originating in Heyford Park and travelling away
- Trips originating away and travelling to employment at Heyford Park

Trips were applied onto OS base mapping using the most direct routes taking account of road hierarchy but also using local knowledge gained from a member of the study team who lived in the area for nine years and advice from an Ardley parish councillor regarding local congestion hotspots and 'rat-running'. The routes were allocated accordingly.

Once all trips were allocated onto the network, percentages were calculated for each link between the junctions for assessment and for trips passing through the junctions themselves.

Assumptions

The following assumptions were made concerning trips with Heyford Park as origin:

- The 7% total for the M40 southbound were allocated; 3% via Ardley, 2% via Chesterton and 2% via Weston-on-the-Green.
- M40 northbound comprises 3% Banbury Grimsbury and 3% points further north
- 6% to Kidlington were allocated; 2% via Hopcrofts Holt and 4% via Bunkers Hill
- Oxford, Vale of White Horse and South West totalled 13%. 8% was allocated via Weston-on-the-Green, 2% via Kirklington, 2% via Bunkers Hill and 1% via Hopcrofts Holt
- All 3% to South Oxfordshire was allocated via Weston-on-the-Green

-
- 3% of the 15% 'internal' within the Heyford Park Super Output Area, (including 1% to the rest of Astons and the Heyfords) was allocated to Upper Heyford Village.
 - The remaining 12% are assumed to be trips within Heyford Park
 - Percentages do not sum due to rounding.

The following assumptions were made concerning trips with Heyford Park as destination:

- Of the 10% internal trips, 3% are assumed from Upper Heyford Village and 7% within the site
- The rest of the Astons and the Heyfords Ward had 5% of trips. These were assumed to be 2% via Somerton, 2% via Lower Heyford and 1% via Ardley
- The M40 southbound trips exiting at Jcn 10 totalled 12%, comprising Banbury Grimsbury 3%, Middleton Cheney 1%, Wardoun 1%, West Midlands 5%, North West 1%, Wales 1%
- The M40 northbound trips exiting at Jcn 10 totalled 4%, comprising Wycombe 1%, Berkshire 2%, London 1%
- Oxford, Vale of White Horse and South West totalled 5%. 3% was allocated via Weston-on-the-Green, 2% via Kirklington
- Percentages do not sum due to rounding.

Appendix D

**Local Highway
Network: Junction
Analyses**

TRL LIMITED

(C) COPYRIGHT 2006

CAPACITIES, QUEUES, AND DELAYS AT 3 OR 4-ARM MAJOR/MINOR PRIORITY JUNCTIONS

PICADY 5.0 ANALYSIS PROGRAM
RELEASE 3.0 (JUNE 2006)

ADAPTED FROM PICADY/3 WHICH IS CROWN COPYRIGHT
BY PERMISSION OF THE CONTROLLER OF HMSO

FOR SALES AND DISTRIBUTION INFORMATION,
PROGRAM ADVICE AND MAINTENANCE CONTACT:
TRL SOFTWARE BUREAU
TEL: CROWTHORNE (01344) 770758, FAX: 770864
EMAIL: SoftwareBureau@trl.co.uk

THE USER OF THIS COMPUTER PROGRAM FOR THE SOLUTION OF AN ENGINEERING PROBLEM IS
IN NO WAY RELIEVED OF HIS RESPONSIBILITY FOR THE CORRECTNESS OF THE SOLUTION

Run with file:-

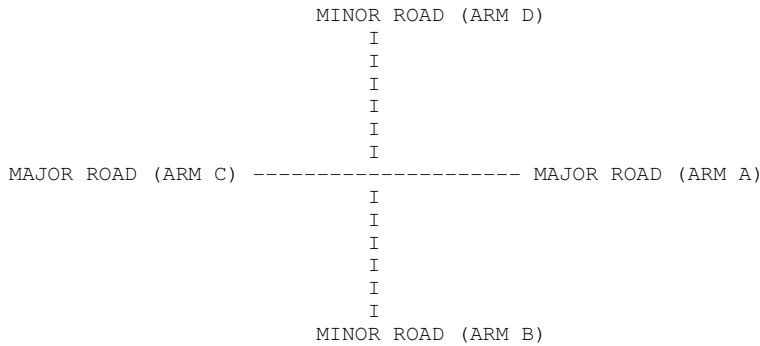
"J:\120000\120669-00\4 Internal Project Data\4-04 Calculations\4-04-06 Junction Analysis\Picady\
Site 4. B4030 Lower Heyford Rd - Port Way\2006 Base\AM\Site 4.Lower Heyford - Port Way 2006 Base AM.vpi"
(drive-on-the-left) at 08:49:43 on Wednesday, 11 July 2007

RUN INFORMATION

RUN TITLE: Site 4. Lower Heyford Rd - Port Way 2006 Base AM
LOCATION: Oxfordshire
DATE: 06/12/06
CLIENT: North Oxfordshire Consortium
ENUMERATOR: chris.morris [MCCPC062011]
JOB NUMBER: 120669
STATUS: TIA
DESCRIPTION:

.MAJOR/MINOR JUNCTION CAPACITY AND DELAY

INPUT DATA



ARM A IS Lower Heyford Road (E)
ARM B IS Port Way (S)
ARM C IS Lower Heyford Road (W)
ARM D IS Port Way (N)

STREAM LABELLING CONVENTION

STREAM A-B CONTAINS TRAFFIC GOING FROM ARM A TO ARM B
STREAM B-AC CONTAINS TRAFFIC GOING FROM ARM B TO ARM A AND TO ARM C
ETC.

 GEOMETRIC DATA

| I | DATA ITEM | I | MINOR ROAD B | I | MINOR ROAD D | I |
|---|------------------------------------|---|-----------------|---|-----------------|---|
| I | TOTAL MAJOR ROAD CARRIAGEWAY WIDTH | I | (W) 7.00 M. | I | (W) 7.00 M. | I |
| I | CENTRAL RESERVE WIDTH | I | (WCR) 0.00 M. | I | (WCR) 0.00 M. | I |
| I | | I | | I | | I |
| I | MAJOR ROAD RIGHT TURN - WIDTH | I | (WC-B) 2.20 M. | I | (WA-D) 2.20 M. | I |
| I | - VISIBILITY | I | (VC-B) 150.0 M. | I | (VA-D) 150.0 M. | I |
| I | - BLOCKS TRAFFIC | I | YES | I | YES | I |
| I | | I | | I | | I |
| I | MINOR ROAD - VISIBILITY TO LEFT | I | (VB-C) 38.0 M. | I | (VD-A) 95.0 M. | I |
| I | - VISIBILITY TO RIGHT | I | (VB-A) 72.0 M. | I | (VD-C) 92.0 M. | I |
| I | - LANE 1 WIDTH | I | (WB-C) - | I | (WD-A) - | I |
| I | - LANE 2 WIDTH | I | (WB-A) - | I | (WD-C) - | I |
| I | - WIDTH AT 0 M FROM JUNC. | I | 10.00 M. | I | 10.00 M. | I |
| I | - WIDTH AT 5 M FROM JUNC. | I | 6.00 M. | I | 8.00 M. | I |
| I | - WIDTH AT 10 M FROM JUNC. | I | 4.50 M. | I | 5.80 M. | I |
| I | - WIDTH AT 15 M FROM JUNC. | I | 4.10 M. | I | 4.00 M. | I |
| I | - WIDTH AT 20 M FROM JUNC. | I | 3.70 M. | I | 3.20 M. | I |
| I | - LENGTH OF FLARED SECTION | I | DERIVED: 1 PCU | I | 2 VEHS | I |

.SLOPES AND INTERCPET

(NB:Streams may be combined, in which case capacity will be adjusted)

B-C Stream

| I | Intercept For Stream B-C | Slope For Opposing Stream A-C | Slope For Opposing Stream A-B | I |
|---|--------------------------|-------------------------------|-------------------------------|---|
| I | 615.66 | 0.23 | 0.09 | I |

D-A Stream

| I | Intercept For Stream D-A | Slope For Opposing Stream C-A | Slope For Opposing Stream C-D | I |
|---|--------------------------|-------------------------------|-------------------------------|---|
| I | 627.24 | 0.23 | 0.09 | I |

B-A Stream

| I | Intercept For Stream B-A | Slope For Opposing Stream A-C | Slope For Opposing Stream A-D | Slope For Opposing Stream D-A | Slope For Opposing Stream D-B | I |
|---|--------------------------|-------------------------------|-------------------------------|-------------------------------|-------------------------------|---|
| I | 483.33 | 0.21 | 0.21 | 0.21 | 0.21 | I |

| I | Slope For Opposing Stream A-B | Slope For Opposing Stream C-A | Slope For Opposing Stream C-B | Slope For Opposing Stream D-C | I |
|---|-------------------------------|-------------------------------|-------------------------------|-------------------------------|---|
| I | 0.08 | 0.13 | 0.30 | 0.11 | I |

D-C Stream

| I | Intercept For Stream D-C | Slope For Opposing Stream C-A | Slope For Opposing Stream C-B | Slope For Opposing Stream B-C | Slope For Opposing Stream B-D | I |
|---|--------------------------|-------------------------------|-------------------------------|-------------------------------|-------------------------------|---|
| I | 510.47 | 0.22 | 0.22 | 0.22 | 0.22 | I |

| I | Slope For Opposing Stream C-D | Slope For Opposing Stream A-C | Slope For Opposing Stream A-D | Slope For Opposing Stream B-A | I |
|---|-------------------------------|-------------------------------|-------------------------------|-------------------------------|---|
| I | 0.09 | 0.14 | 0.32 | 0.11 | I |

C-B Stream

| I | Intercept For Stream C-B | Slope For Opposing Stream A-C | Slope For Opposing Stream A-D | I |
|---|--------------------------|-------------------------------|-------------------------------|---|
| I | 660.83 | 0.24 | 0.35 | I |

A-D Stream

| I | Intercept For Stream A-D | Slope For Opposing Stream C-A | Slope For Opposing Stream C-B | I |
|---|--------------------------|-------------------------------|-------------------------------|---|
| I | 660.83 | 0.24 | 0.35 | I |

B-D Stream From Left Hand Lane

| I | Intercept For Stream B-D | Slope For Opposing Stream A-C | Slope For Opposing Stream A-D | Slope For Opposing Stream A-B | Slope For Opposing Stream C-B | I |
|---|--------------------------|-------------------------------|-------------------------------|-------------------------------|-------------------------------|---|
| I | 483.33 | 0.21 | 0.21 | 0.08 | 0.30 | I |

| I | Slope For Opposing Stream C-A | Slope For Opposing Stream C-D | Slope For Opposing Stream C-B | I |
|---|-------------------------------|-------------------------------|-------------------------------|---|
| I | 0.13 | 0.13 | | I |

B-D Stream From Right Hand Lane

| I | Intercept For Stream B-D | Slope For Opposing Stream A-C | Slope For Opposing Stream A-D | Slope For Opposing Stream A-B | Slope For Opposing Stream C-B | I |
|---|--------------------------|-------------------------------|-------------------------------|-------------------------------|-------------------------------|---|
| I | 483.33 | 0.21 | 0.21 | 0.08 | 0.30 | I |

| I | Slope For Opposing Stream C-A | Slope For Opposing Stream C-D | Slope For Opposing Stream C-B | I |
|---|-------------------------------|-------------------------------|-------------------------------|---|
| I | 0.13 | 0.13 | | I |

D-B Stream From Left Hand Lane

| I | Intercept For Stream D-B | Slope For Opposing Stream C-A | Slope For Opposing Stream C-B | Slope For Opposing Stream D-C | Slope For Opposing Stream A-D | I |
|---|--------------------------|-------------------------------|-------------------------------|-------------------------------|-------------------------------|---|
| I | 510.47 | 0.22 | 0.22 | 0.09 | 0.32 | I |

| I | Slope For Opposing Stream A-C | Slope For Opposing Stream A-B | Slope For Opposing Stream C-B | I |
|---|-------------------------------|-------------------------------|-------------------------------|---|
| I | 0.14 | 0.14 | | I |

D-B Stream From Right Hand Lane

| I | Intercept For Stream D-B | Slope For Opposing Stream C-A | Slope For Opposing Stream C-B | Slope For Opposing Stream C-D | Slope For Opposing Stream A-D | I |
|---|--------------------------|-------------------------------|-------------------------------|-------------------------------|-------------------------------|---|
| I | 510.47 | 0.22 | 0.22 | 0.09 | 0.32 | I |

| I | Slope For Opposing Stream A-C | Slope For Opposing Stream A-B | Slope For Opposing Stream C-B | I |
|---|-------------------------------|-------------------------------|-------------------------------|---|
| I | 0.14 | 0.14 | | I |

TRAFFIC DEMAND DATA

| ARM | FLOW SCALE (%) |
|-----|----------------|
| A | 100 |
| B | 100 |
| C | 100 |
| D | 100 |

Demand set: Site 4. Lower Heyford Rd - Port Way 2006 Existing AM

TIME PERIOD BEGINS 07.45 AND ENDS 09.15

LENGTH OF TIME PERIOD - 90 MINUTES.
 LENGTH OF TIME SEGMENT - 15 MINUTES.

DEMAND FLOW PROFILES ARE SYNTHESISED FROM TURNING COUNT DATA

| ARM | NUMBER OF MINUTES FROM START WHEN FLOW STARTS TO RISE | TOP OF PEAK IS REACHED | FLOW STOPS FALLING | RATE OF FLOW (VEH/MIN) BEFORE PEAK | AT TOP OF PEAK | AFTER PEAK |
|-------|---|------------------------|--------------------|------------------------------------|----------------|------------|
| ARM A | 15.00 | 45.00 | 75.00 | 1.69 | 2.53 | 1.69 |
| ARM B | 15.00 | 45.00 | 75.00 | 0.91 | 1.37 | 0.91 |
| ARM C | 15.00 | 45.00 | 75.00 | 2.56 | 3.84 | 2.56 |
| ARM D | 15.00 | 45.00 | 75.00 | 0.28 | 0.41 | 0.28 |

| TIME | TURNING PROPORTIONS | | | | |
|---------------|---------------------|--------|--------|--------|--------|
| | FROM/TO | ARM A | ARM B | ARM C | ARM D |
| 07.45 - 09.15 | ARM A | 0.000 | 0.111 | 0.889 | 0.000 |
| | | (0.0) | (0.0) | (0.0) | (0.0) |
| | ARM B | 0.534 | 0.000 | 0.411 | 0.055 |
| | | 39.0 | 0.0 | 30.0 | 4.0 |
| | | (0.0) | (0.0) | (0.0) | (0.0) |
| | ARM C | 0.761 | 0.239 | 0.000 | 0.000 |
| | | 156.0 | 49.0 | 0.0 | 0.0 |
| | | (0.0) | (0.0) | (0.0) | (0.0) |
| | ARM D | 0.091 | 0.818 | 0.091 | 0.000 |
| | | 2.0 | 18.0 | 2.0 | 0.0 |
| | | (0.0) | (0.0) | (0.0) | (0.0) |

TURNING PROPORTIONS ARE CALCULATED FROM TURNING COUNT DATA

QUEUE AND DELAY INFORMATION FOR EACH 15 MIN TIME SEGMENT

FOR COMBINED DEMAND SETS
 AND FOR TIME PERIOD 1

| TIME | DEMAND (VEH/MIN) | CAPACITY (VEH/MIN) | DEMAND/CAPACITY (RFC) | PEDESTRIAN FLOW (PEDS/MIN) | START QUEUE (VEHS) | END QUEUE (VEHS) | DELAY (VEH.MIN/TIME SEGMENT) | GEOMETRIC DELAY (VEH.MIN/TIME SEGMENT) | AVERAGE DELAY PER ARRIVING VEHICLE (MIN) |
|--|------------------|--------------------|-----------------------|----------------------------|-----------------------------------|-------------------------|------------------------------|--|--|
| 07.45-08.00 | | | | | | | | | |
| B-CD | 0.40 | 10.65 | 0.038 | | 0.00 | 0.04 | 0.6 | | 0.10 |
| B-AD | 0.51 | 8.27 | 0.062 | | 0.00 | 0.07 | 0.9 | | 0.13 |
| A-BCD | 0.00 | 9.38 | 0.000 | | 0.00 | 0.00 | 0.0 | | 0.00 |
| D-AB | 0.14 | 10.43 | 0.013 | | 0.00 | 0.01 | 0.2 | | 0.10 |
| D-BC | 0.14 | 8.28 | 0.017 | | 0.00 | 0.02 | 0.2 | | 0.12 |
| C-ABD | 0.61 | 10.60 | 0.058 | | 0.00 | 0.06 | 0.9 | | 0.10 |
| EFFECT ON CAPACITY (PCU/MIN) OF MARGINAL CHANGES IN: | | | | | | | | | |
| MARGINAL CHANGE: | LANE WIDTH (.1M) | WIDTH (.1M) | MAJOR RD. WIDTH (.1M) | CENT RES WIDTH (.1M) | VIS TO LEFT (AHEAD FOR MAJOR) (M) | VISIBILITY TO RIGHT (M) | | | |
| B-CD | 0.104 | 0.002 | 0.002 | 0.001 | 0.010 | | | | |
| B-AD | 0.078 | 0.004 | 0.021 | 0.005 | 0.008 | | | | |
| C-ABD | 0.115 | 0.002 | | 0.009 | | | | | |
| D-AB | 0.087 | 0.005 | 0.022 | 0.006 | 0.010 | | | | |
| D-BC | 0.083 | 0.004 | 0.021 | 0.005 | 0.008 | | | | |
| A-BCD | 0.112 | 0.003 | | 0.009 | | | | | |

| I | TIME | DEMAND (VEH/MIN) | CAPACITY (VEH/MIN) | DEMAND/ CAPACITY (RFC) | PEDESTRIAN FLOW (PEDS/MIN) | START QUEUE (VEHS) | END QUEUE (VEHS) | DELAY (VEH.MIN/ TIME SEGMENT) | GEOMETRIC DELAY (VEH.MIN/ TIME SEGMENT) | AVERAGE DELAY PER ARRIVING VEHICLE (MIN) | I |
|---|--|---------------------|-----------------------|------------------------------|----------------------------------|--------------------------|------------------------|-------------------------------------|---|--|---|
| I | 08.00-08.15 | | | | | | | | | | I |
| I | B-CD | 0.48 | 10.52 | 0.046 | | 0.04 | 0.05 | 0.7 | | 0.10 | I |
| I | B-AD | 0.61 | 8.08 | 0.076 | | 0.07 | 0.08 | 1.2 | | 0.13 | I |
| I | A-BCD | 0.00 | 9.26 | 0.000 | | 0.00 | 0.00 | 0.0 | | 0.00 | I |
| I | D-AB | 0.17 | 10.22 | 0.016 | | 0.01 | 0.02 | 0.2 | | 0.10 | I |
| I | D-BC | 0.16 | 8.10 | 0.020 | | 0.02 | 0.02 | 0.3 | | 0.13 | I |
| I | C-ABD | 0.73 | 10.52 | 0.070 | | 0.06 | 0.08 | 1.1 | | 0.10 | I |
| I | | | | | | | | | | | I |
| I | EFFECT ON CAPACITY (PCU/MIN) OF MARGINAL CHANGES IN: | | | | | | | | | | I |
| I | MARGINAL | LANE WIDTH | CAPACITY | MAJOR RD. | CENT RES | VIS TO LEFT | VISIBILITY | | | | I |
| I | CHANGE: | (.1M) | (.1M) | (.1M) | (.1M) | (AHEAD FOR MAJOR) | TO RIGHT | | | | I |
| I | | | | | | (M) | (M) | | | | I |
| I | B-CD | 0.102 | 0.002 | 0.002 | 0.001 | 0.010 | | | | | I |
| I | B-AD | 0.077 | 0.005 | 0.021 | 0.005 | 0.008 | | | | | I |
| I | C-ABD | 0.114 | 0.002 | 0.009 | | | | | | | I |
| I | D-AB | 0.085 | 0.006 | 0.022 | 0.005 | 0.009 | | | | | I |
| I | D-BC | 0.082 | 0.005 | 0.021 | 0.005 | 0.007 | | | | | I |
| I | A-BCD | 0.111 | 0.004 | 0.009 | | | | | | | I |

| I | TIME | DEMAND (VEH/MIN) | CAPACITY (VEH/MIN) | DEMAND/ CAPACITY (RFC) | PEDESTRIAN FLOW (PEDS/MIN) | START QUEUE (VEHS) | END QUEUE (VEHS) | DELAY (VEH.MIN/ TIME SEGMENT) | GEOMETRIC DELAY (VEH.MIN/ TIME SEGMENT) | AVERAGE DELAY PER ARRIVING VEHICLE (MIN) | I |
|---|--|---------------------|-----------------------|------------------------------|----------------------------------|--------------------------|------------------------|-------------------------------------|---|--|---|
| I | 08.15-08.30 | | | | | | | | | | I |
| I | B-CD | 0.59 | 10.34 | 0.057 | | 0.05 | 0.06 | 0.9 | | 0.10 | I |
| I | B-AD | 0.75 | 7.82 | 0.096 | | 0.08 | 0.10 | 1.5 | | 0.14 | I |
| I | A-BCD | 0.00 | 9.09 | 0.000 | | 0.00 | 0.00 | 0.0 | | 0.00 | I |
| I | D-AB | 0.20 | 9.93 | 0.020 | | 0.02 | 0.02 | 0.3 | | 0.10 | I |
| I | D-BC | 0.20 | 7.86 | 0.026 | | 0.02 | 0.03 | 0.4 | | 0.13 | I |
| I | C-ABD | 0.90 | 10.41 | 0.086 | | 0.08 | 0.10 | 1.4 | | 0.11 | I |
| I | | | | | | | | | | | I |
| I | EFFECT ON CAPACITY (PCU/MIN) OF MARGINAL CHANGES IN: | | | | | | | | | | I |
| I | MARGINAL | LANE WIDTH | CAPACITY | MAJOR RD. | CENT RES | VIS TO LEFT | VISIBILITY | | | | I |
| I | CHANGE: | (.1M) | (.1M) | (.1M) | (.1M) | (AHEAD FOR MAJOR) | TO RIGHT | | | | I |
| I | | | | | | (M) | (M) | | | | I |
| I | B-CD | 0.101 | 0.003 | 0.003 | 0.001 | 0.009 | | | | | I |
| I | B-AD | 0.074 | 0.006 | 0.021 | 0.005 | 0.007 | | | | | I |
| I | C-ABD | 0.113 | 0.003 | 0.009 | | | | | | | I |
| I | D-AB | 0.083 | 0.007 | 0.022 | 0.005 | 0.009 | | | | | I |
| I | D-BC | 0.079 | 0.006 | 0.021 | 0.005 | 0.007 | | | | | I |
| I | A-BCD | 0.109 | 0.005 | 0.009 | | | | | | | I |

| I | TIME | DEMAND (VEH/MIN) | CAPACITY (VEH/MIN) | DEMAND/ CAPACITY (RFC) | PEDESTRIAN FLOW (PEDS/MIN) | START QUEUE (VEHS) | END QUEUE (VEHS) | DELAY (VEH.MIN/ TIME SEGMENT) | GEOMETRIC DELAY (VEH.MIN/ TIME SEGMENT) | AVERAGE DELAY PER ARRIVING VEHICLE (MIN) | I |
|---|--|---------------------|-----------------------|------------------------------|----------------------------------|--------------------------|------------------------|-------------------------------------|---|--|---|
| I | 08.30-08.45 | | | | | | | | | | I |
| I | B-CD | 0.59 | 10.34 | 0.057 | | 0.06 | 0.06 | 0.9 | | 0.10 | I |
| I | B-AD | 0.75 | 7.82 | 0.096 | | 0.10 | 0.11 | 1.6 | | 0.14 | I |
| I | A-BCD | 0.00 | 9.09 | 0.000 | | 0.00 | 0.00 | 0.0 | | 0.00 | I |
| I | D-AB | 0.20 | 9.93 | 0.020 | | 0.02 | 0.02 | 0.3 | | 0.10 | I |
| I | D-BC | 0.20 | 7.86 | 0.026 | | 0.03 | 0.03 | 0.4 | | 0.13 | I |
| I | C-ABD | 0.90 | 10.41 | 0.086 | | 0.10 | 0.10 | 1.5 | | 0.11 | I |
| I | | | | | | | | | | | I |
| I | EFFECT ON CAPACITY (PCU/MIN) OF MARGINAL CHANGES IN: | | | | | | | | | | I |
| I | MARGINAL | LANE WIDTH | CAPACITY | MAJOR RD. | CENT RES | VIS TO LEFT | VISIBILITY | | | | I |
| I | CHANGE: | (.1M) | (.1M) | (.1M) | (.1M) | (AHEAD FOR MAJOR) | TO RIGHT | | | | I |
| I | | | | | | (M) | (M) | | | | I |
| I | B-CD | 0.101 | 0.003 | 0.003 | 0.001 | 0.009 | | | | | I |
| I | B-AD | 0.074 | 0.006 | 0.021 | 0.005 | 0.007 | | | | | I |
| I | C-ABD | 0.113 | 0.003 | 0.009 | | | | | | | I |
| I | D-AB | 0.083 | 0.007 | 0.022 | 0.005 | 0.009 | | | | | I |
| I | D-BC | 0.079 | 0.006 | 0.021 | 0.005 | 0.007 | | | | | I |
| I | A-BCD | 0.109 | 0.005 | 0.009 | | | | | | | I |

| I | TIME | DEMAND (VEH/MIN) | CAPACITY (VEH/MIN) | DEMAND/ CAPACITY (RFC) | PEDESTRIAN FLOW (PEDS/MIN) | START QUEUE (VEHS) | END QUEUE (VEHS) | DELAY (VEH.MIN/ TIME SEGMENT) | GEOMETRIC DELAY (VEH.MIN/ TIME SEGMENT) | AVERAGE DELAY PER ARRIVING VEHICLE (MIN) | I |
|---|-------------|---------------------|-----------------------|------------------------------|----------------------------------|--------------------------|------------------------|-------------------------------------|---|--|---|
| I | 08.45-09.00 | | | | | | | | | | I |
| I | B-CD | 0.48 | 10.52 | 0.046 | | 0.06 | 0.05 | 0.7 | | 0.10 | I |
| I | B-AD | 0.61 | 8.08 | 0.076 | | 0.11 | 0.08 | 1.3 | | 0.13 | I |
| I | A-BCD | 0.00 | 9.26 | 0.000 | | 0.00 | 0.00 | 0.0 | | 0.00 | I |
| I | D-AB | 0.17 | 10.22 | 0.016 | | 0.02 | 0.02 | 0.3 | | 0.10 | I |
| I | D-BC | 0.16 | 8.10 | 0.020 | | 0.03 | 0.02 | 0.3 | | 0.13 | I |
| I | C-ABD | 0.73 | 10.52 | 0.070 | | 0.10 | 0.08 | 1.2 | | 0.10 | I |
| I | | | | | | | | | | | I |
| I | | | | | | | | | | | I |
| I | | | | | | | | | | | I |
| I | | | | | | | | | | | I |
| I | | | | | | | | | | | I |
| I | | | | | | | | | | | I |
| I | | | | | | | | | | | I |
| I | | | | | | | | | | | I |
| I | | | | | | | | | | | I |
| I | | | | | | | | | | | I |
| I | | | | | | | | | | | I |
| I | | | | | | | | | | | I |
| I | | | | | | | | | | | I |
| I | | | | | | | | | | | I |
| I | | | | | | | | | | | I |
| I | | | | | | | | | | | I |

| I | TIME | DEMAND (VEH/MIN) | CAPACITY (VEH/MIN) | DEMAND/ CAPACITY (RFC) | PEDESTRIAN FLOW (PEDS/MIN) | START QUEUE (VEHS) | END QUEUE (VEHS) | DELAY (VEH.MIN/ TIME SEGMENT) | GEOMETRIC DELAY (VEH.MIN/ TIME SEGMENT) | AVERAGE DELAY PER ARRIVING VEHICLE (MIN) | I |
|---|-------------|---------------------|-----------------------|------------------------------|----------------------------------|--------------------------|------------------------|-------------------------------------|---|--|---|
| I | 09.00-09.15 | | | | | | | | | | I |
| I | B-CD | 0.40 | 10.65 | 0.038 | | 0.05 | 0.04 | 0.6 | | 0.10 | I |
| I | B-AD | 0.51 | 8.26 | 0.062 | | 0.08 | 0.07 | 1.0 | | 0.13 | I |
| I | A-BCD | 0.00 | 9.38 | 0.000 | | 0.00 | 0.00 | 0.0 | | 0.00 | I |
| I | D-AB | 0.14 | 10.43 | 0.013 | | 0.02 | 0.01 | 0.2 | | 0.10 | I |
| I | D-BC | 0.14 | 8.28 | 0.017 | | 0.02 | 0.02 | 0.3 | | 0.12 | I |
| I | C-ABD | 0.61 | 10.60 | 0.058 | | 0.08 | 0.06 | 0.9 | | 0.10 | I |
| I | | | | | | | | | | | I |
| I | | | | | | | | | | | I |
| I | | | | | | | | | | | I |
| I | | | | | | | | | | | I |
| I | | | | | | | | | | | I |
| I | | | | | | | | | | | I |
| I | | | | | | | | | | | I |
| I | | | | | | | | | | | I |
| I | | | | | | | | | | | I |
| I | | | | | | | | | | | I |
| I | | | | | | | | | | | I |
| I | | | | | | | | | | | I |
| I | | | | | | | | | | | I |

QUEUE FOR STREAM B-CD

| TIME SEGMENT | NO. OF VEHICLES IN QUEUE |
|--------------|--------------------------|
| 08.00 | 0.0 |
| 08.15 | 0.0 |
| 08.30 | 0.1 |
| 08.45 | 0.1 |
| 09.00 | 0.0 |
| 09.15 | 0.0 |

QUEUE FOR STREAM B-AD

| TIME SEGMENT | NO. OF VEHICLES IN QUEUE |
|--------------|--------------------------|
| 08.00 | 0.1 |
| 08.15 | 0.1 |
| 08.30 | 0.1 |
| 08.45 | 0.1 |
| 09.00 | 0.1 |
| 09.15 | 0.1 |

QUEUE FOR STREAM A-BCD

| TIME SEGMENT | NO. OF VEHICLES IN QUEUE |
|--------------|--------------------------|
| 08.00 | 0.0 |
| 08.15 | 0.0 |
| 08.30 | 0.0 |
| 08.45 | 0.0 |
| 09.00 | 0.0 |
| 09.15 | 0.0 |

QUEUE FOR STREAM D-AB

| TIME SEGMENT ENDING | NO. OF VEHICLES IN QUEUE |
|---------------------|--------------------------|
| 08.00 | 0.0 |
| 08.15 | 0.0 |
| 08.30 | 0.0 |
| 08.45 | 0.0 |
| 09.00 | 0.0 |
| 09.15 | 0.0 |

QUEUE FOR STREAM D-BC

| TIME SEGMENT ENDING | NO. OF VEHICLES IN QUEUE |
|---------------------|--------------------------|
| 08.00 | 0.0 |
| 08.15 | 0.0 |
| 08.30 | 0.0 |
| 08.45 | 0.0 |
| 09.00 | 0.0 |
| 09.15 | 0.0 |

QUEUE FOR STREAM C-ABD

| TIME SEGMENT ENDING | NO. OF VEHICLES IN QUEUE |
|---------------------|--------------------------|
| 08.00 | 0.1 |
| 08.15 | 0.1 |
| 08.30 | 0.1 |
| 08.45 | 0.1 |
| 09.00 | 0.1 |
| 09.15 | 0.1 |

QUEUEING DELAY INFORMATION OVER WHOLE PERIOD

| I | STREAM | I | TOTAL DEMAND | I | * QUEUEING * | I | * INCLUSIVE QUEUEING * | I | | |
|---|--------|-----------|--------------|-------|--------------|-----------|------------------------|-------|------|---|
| I | I | I | I | I | * DELAY * | I | * DELAY * | I | | |
| I | I | (VEH) | (VEH/H) | I | (MIN) | (MIN/VEH) | I | (MIN) | | |
| I | I | (MIN/VEH) | I | (MIN) | (MIN/VEH) | I | (MIN/VEH) | I | | |
| I | B-CD | I | 44.3 | I | 29.5 | I | 4.4 | I | 0.10 | I |
| I | B-AD | I | 56.2 | I | 37.5 | I | 7.6 | I | 0.13 | I |
| I | A-BCD | I | 0.0 | I | 0.0 | I | 0.0 | I | 0.00 | I |
| I | D-AB | I | 15.2 | I | 10.1 | I | 1.5 | I | 0.10 | I |
| I | D-BC | I | 15.1 | I | 10.1 | I | 1.9 | I | 0.13 | I |
| I | C-ABD | I | 67.4 | I | 45.0 | I | 7.0 | I | 0.10 | I |
| I | ALL | I | 598.7 | I | 399.2 | I | 22.4 | I | 0.04 | I |

* DELAY IS THAT OCCURRING ONLY WITHIN THE TIME PERIOD .
 * INCLUSIVE DELAY INCLUDES DELAY SUFFERED BY VEHICLES WHICH ARE STILL QUEUEING AFTER THE END OF THE TIME PERIOD.
 * THESE WILL ONLY BE SIGNIFICANTLY DIFFERENT IF THERE IS A LARGE QUEUE REMAINING AT THE END OF THE TIME PERIOD.

END OF JOB

===== end of file =====

TRL LIMITED

(C) COPYRIGHT 2006

CAPACITIES, QUEUES, AND DELAYS AT 3 OR 4-ARM MAJOR/MINOR PRIORITY JUNCTIONS

PICADY 5.0 ANALYSIS PROGRAM
RELEASE 3.0 (JUNE 2006)

ADAPTED FROM PICADY/3 WHICH IS CROWN COPYRIGHT
BY PERMISSION OF THE CONTROLLER OF HMSO

FOR SALES AND DISTRIBUTION INFORMATION,
PROGRAM ADVICE AND MAINTENANCE CONTACT:
TRL SOFTWARE BUREAU
TEL: CROWTHORNE (01344) 770758, FAX: 770864
EMAIL: SoftwareBureau@trl.co.uk

THE USER OF THIS COMPUTER PROGRAM FOR THE SOLUTION OF AN ENGINEERING PROBLEM IS
IN NO WAY RELIEVED OF HIS RESPONSIBILITY FOR THE CORRECTNESS OF THE SOLUTION

Run with file:-

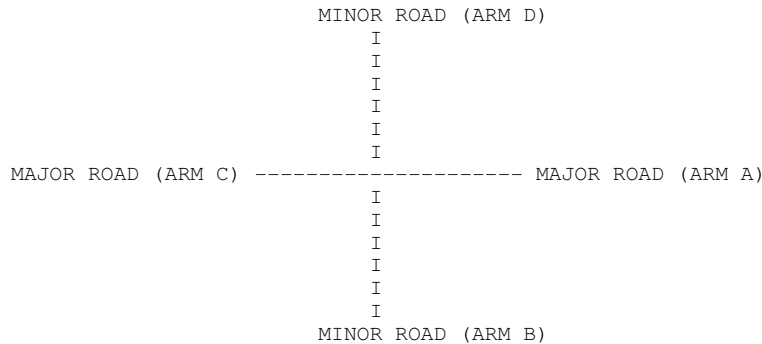
"J:\120000\120669-00\4 Internal Project Data\4-04 Calculations\4-04-06 Junction Analysis\Picady\
Site 4. B4030 Lower Heyford Rd - Port Way\2006 Base\PM\Site 4.Lower Heyford - Port Way 2006 Base PM.vpi"
(drive-on-the-left) at 08:52:01 on Wednesday, 11 July 2007

RUN INFORMATION

RUN TITLE: Site 4. Lower Heyford Rd - Port Way 2006 Base PM
LOCATION: Oxfordshire
DATE: 06/12/06
CLIENT: North Oxfordshire Consortium
ENUMERATOR: chris.morris [MCCPC062011]
JOB NUMBER: 120669
STATUS: TIA
DESCRIPTION:

.MAJOR/MINOR JUNCTION CAPACITY AND DELAY

INPUT DATA



ARM A IS Lower Heyford Road (E)
ARM B IS Port Way (S)
ARM C IS Lower Heyford Road (W)
ARM D IS Port Way (N)

STREAM LABELLING CONVENTION

STREAM A-B CONTAINS TRAFFIC GOING FROM ARM A TO ARM B
STREAM B-AC CONTAINS TRAFFIC GOING FROM ARM B TO ARM A AND TO ARM C
ETC.

 GEOMETRIC DATA

| I | DATA ITEM | I | MINOR ROAD B | I | MINOR ROAD D | I |
|---|------------------------------------|---|-----------------|---|-----------------|---|
| I | TOTAL MAJOR ROAD CARRIAGEWAY WIDTH | I | (W) 7.00 M. | I | (W) 7.00 M. | I |
| I | CENTRAL RESERVE WIDTH | I | (WCR) 0.00 M. | I | (WCR) 0.00 M. | I |
| I | | I | | I | | I |
| I | MAJOR ROAD RIGHT TURN - WIDTH | I | (WC-B) 2.20 M. | I | (WA-D) 2.20 M. | I |
| I | - VISIBILITY | I | (VC-B) 150.0 M. | I | (VA-D) 150.0 M. | I |
| I | - BLOCKS TRAFFIC | I | YES | I | YES | I |
| I | | I | | I | | I |
| I | MINOR ROAD - VISIBILITY TO LEFT | I | (VB-C) 38.0 M. | I | (VD-A) 95.0 M. | I |
| I | - VISIBILITY TO RIGHT | I | (VB-A) 72.0 M. | I | (VD-C) 92.0 M. | I |
| I | - LANE 1 WIDTH | I | (WB-C) - | I | (WD-A) - | I |
| I | - LANE 2 WIDTH | I | (WB-A) - | I | (WD-C) - | I |
| I | - WIDTH AT 0 M FROM JUNC. | I | 10.00 M. | I | 10.00 M. | I |
| I | - WIDTH AT 5 M FROM JUNC. | I | 6.00 M. | I | 8.00 M. | I |
| I | - WIDTH AT 10 M FROM JUNC. | I | 4.50 M. | I | 5.80 M. | I |
| I | - WIDTH AT 15 M FROM JUNC. | I | 4.10 M. | I | 4.00 M. | I |
| I | - WIDTH AT 20 M FROM JUNC. | I | 3.70 M. | I | 3.20 M. | I |
| I | - LENGTH OF FLARED SECTION | I | DERIVED: 1 PCU | I | 2 VEHS | I |

.SLOPES AND INTERCPET

(NB:Streams may be combined, in which case capacity will be adjusted)

B-C Stream

| I | Intercept For Stream B-C | Slope For Opposing Stream A-C | Slope For Opposing Stream A-B | I |
|---|--------------------------|-------------------------------|-------------------------------|---|
| I | 615.66 | 0.23 | 0.09 | I |

D-A Stream

| I | Intercept For Stream D-A | Slope For Opposing Stream C-A | Slope For Opposing Stream C-D | I |
|---|--------------------------|-------------------------------|-------------------------------|---|
| I | 627.24 | 0.23 | 0.09 | I |

B-A Stream

| I | Intercept For Stream B-A | Slope For Opposing Stream A-C | Slope For Opposing Stream A-D | Slope For Opposing Stream D-A | Slope For Opposing Stream D-B | I |
|---|--------------------------|-------------------------------|-------------------------------|-------------------------------|-------------------------------|---|
| I | 483.33 | 0.21 | 0.21 | 0.21 | 0.21 | I |

| I | Slope For Opposing Stream A-B | Slope For Opposing Stream C-A | Slope For Opposing Stream C-B | Slope For Opposing Stream D-C | I |
|---|-------------------------------|-------------------------------|-------------------------------|-------------------------------|---|
| I | 0.08 | 0.13 | 0.30 | 0.11 | I |

D-C Stream

| I | Intercept For Stream D-C | Slope For Opposing Stream C-A | Slope For Opposing Stream C-B | Slope For Opposing Stream B-C | Slope For Opposing Stream B-D | I |
|---|--------------------------|-------------------------------|-------------------------------|-------------------------------|-------------------------------|---|
| I | 510.47 | 0.22 | 0.22 | 0.22 | 0.22 | I |

| I | Slope For Opposing Stream C-D | Slope For Opposing Stream A-C | Slope For Opposing Stream A-D | Slope For Opposing Stream B-A | I |
|---|-------------------------------|-------------------------------|-------------------------------|-------------------------------|---|
| I | 0.09 | 0.14 | 0.32 | 0.11 | I |

C-B Stream

| I | Intercept For Stream C-B | Slope For Opposing Stream A-C | Slope For Opposing Stream A-D | I |
|---|--------------------------|-------------------------------|-------------------------------|---|
| I | 660.83 | 0.24 | 0.35 | I |

A-D Stream

| I | Intercept For Stream A-D | Slope For Opposing Stream C-A | Slope For Opposing Stream C-B | I |
|---|--------------------------|-------------------------------|-------------------------------|---|
| I | 660.83 | 0.24 | 0.35 | I |

B-D Stream From Left Hand Lane

| I | Intercept For Stream B-D | Slope For Opposing Stream A-C | Slope For Opposing Stream A-D | Slope For Opposing Stream A-B | Slope For Opposing Stream C-B | I |
|---|--------------------------|-------------------------------|-------------------------------|-------------------------------|-------------------------------|---|
| I | 483.33 | 0.21 | 0.21 | 0.08 | 0.30 | I |

| I | Slope For Opposing Stream C-A | Slope For Opposing Stream C-D | Slope For Opposing Stream A-B | Slope For Opposing Stream C-B | I |
|---|-------------------------------|-------------------------------|-------------------------------|-------------------------------|---|
| I | 0.13 | 0.13 | | | I |

B-D Stream From Right Hand Lane

| I | Intercept For Stream B-D | Slope For Opposing Stream A-C | Slope For Opposing Stream A-D | Slope For Opposing Stream A-B | Slope For Opposing Stream C-B | I |
|---|--------------------------|-------------------------------|-------------------------------|-------------------------------|-------------------------------|---|
| I | 483.33 | 0.21 | 0.21 | 0.08 | 0.30 | I |

| I | Slope For Opposing Stream C-A | Slope For Opposing Stream C-D | Slope For Opposing Stream A-B | Slope For Opposing Stream C-B | I |
|---|-------------------------------|-------------------------------|-------------------------------|-------------------------------|---|
| I | 0.13 | 0.13 | | | I |

D-B Stream From Left Hand Lane

| I | Intercept For Stream D-B | Slope For Opposing Stream C-A | Slope For Opposing Stream C-B | Slope For Opposing Stream D-C | Slope For Opposing Stream A-D | I |
|---|--------------------------|-------------------------------|-------------------------------|-------------------------------|-------------------------------|---|
| I | 510.47 | 0.22 | 0.22 | 0.09 | 0.32 | I |

| I | Slope For Opposing Stream A-C | Slope For Opposing Stream A-B | Slope For Opposing Stream D-C | Slope For Opposing Stream A-D | I |
|---|-------------------------------|-------------------------------|-------------------------------|-------------------------------|---|
| I | 0.14 | 0.14 | | | I |

D-B Stream From Right Hand Lane

| I | Intercept For Stream D-B | Slope For Opposing Stream C-A | Slope For Opposing Stream C-B | Slope For Opposing Stream C-D | Slope For Opposing Stream A-D | I |
|---|--------------------------|-------------------------------|-------------------------------|-------------------------------|-------------------------------|---|
| I | 510.47 | 0.22 | 0.22 | 0.09 | 0.32 | I |

| I | Slope For Opposing Stream A-C | Slope For Opposing Stream A-B | Slope For Opposing Stream C-D | Slope For Opposing Stream A-D | I |
|---|-------------------------------|-------------------------------|-------------------------------|-------------------------------|---|
| I | 0.14 | 0.14 | | | I |

TRAFFIC DEMAND DATA

| ARM | FLOW SCALE (%) |
|-----|----------------|
| A | 100 |
| B | 100 |
| C | 100 |
| D | 100 |

Demand set: Site 4. Lower Heyford Rd - Port Way 2006 Existing PM

TIME PERIOD BEGINS 16.45 AND ENDS 18.15

LENGTH OF TIME PERIOD - 90 MINUTES.
 LENGTH OF TIME SEGMENT - 15 MINUTES.

DEMAND FLOW PROFILES ARE SYNTHESISED FROM TURNING COUNT DATA

| ARM | NUMBER OF MINUTES FROM START WHEN FLOW STARTS TO RISE | TOP OF PEAK IS REACHED | FLOW STOPS FALLING | RATE OF FLOW (VEH/MIN) BEFORE PEAK | AT TOP OF PEAK | AFTER PEAK |
|-------|---|------------------------|--------------------|------------------------------------|----------------|------------|
| ARM A | 15.00 | 45.00 | 75.00 | 1.88 | 2.81 | 1.88 |
| ARM B | 15.00 | 45.00 | 75.00 | 3.36 | 5.04 | 3.36 |
| ARM C | 15.00 | 45.00 | 75.00 | 1.83 | 2.74 | 1.83 |
| ARM D | 15.00 | 45.00 | 75.00 | 0.09 | 0.13 | 0.09 |

| TIME | TURNING PROPORTIONS | | | | |
|---------------|---------------------|--------|--------|--------|--------|
| | FROM/TO | ARM A | ARM B | ARM C | ARM D |
| 16.45 - 18.15 | ARM A | 0.000 | 0.000 | 0.993 | 0.007 |
| | | (0.0) | (0.0) | (0.0) | (0.0) |
| | ARM B | 0.383 | 0.000 | 0.513 | 0.104 |
| | | 103.0 | 0.0 | 138.0 | 28.0 |
| | | (0.0) | (0.0) | (0.0) | (0.0) |
| | ARM C | 0.760 | 0.055 | 0.000 | 0.185 |
| | | 111.0 | 8.0 | 0.0 | 27.0 |
| | | (0.0) | (0.0) | (0.0) | (0.0) |
| | ARM D | 0.143 | 0.714 | 0.143 | 0.000 |
| | | 1.0 | 5.0 | 1.0 | 0.0 |
| | | (0.0) | (0.0) | (0.0) | (0.0) |

TURNING PROPORTIONS ARE CALCULATED FROM TURNING COUNT DATA

QUEUE AND DELAY INFORMATION FOR EACH 15 MIN TIME SEGMENT

FOR COMBINED DEMAND SETS
 AND FOR TIME PERIOD 1

| TIME | DEMAND (VEH/MIN) | CAPACITY (VEH/MIN) | DEMAND/CAPACITY (RFC) | PEDESTRIAN FLOW (PEDS/MIN) | START QUEUE (VEHS) | END QUEUE (VEHS) | DELAY (VEH.MIN/TIME SEGMENT) | GEOMETRIC DELAY (VEH.MIN/TIME SEGMENT) | AVERAGE DELAY PER ARRIVING VEHICLE (MIN) |
|--|------------------|--------------------|-----------------------|----------------------------|-----------------------------------|------------------|------------------------------|--|--|
| 16.45-17.00 | | | | | | | | | |
| B-CD | 1.93 | 10.28 | 0.188 | | 0.00 | 0.23 | 3.3 | | 0.12 |
| B-AD | 1.44 | 8.35 | 0.173 | | 0.00 | 0.21 | 3.0 | | 0.14 |
| A-BCD | 0.01 | 10.55 | 0.001 | | 0.00 | 0.00 | 0.0 | | 0.09 |
| D-AB | 0.04 | 10.94 | 0.004 | | 0.00 | 0.00 | 0.1 | | 0.09 |
| D-BC | 0.04 | 8.31 | 0.005 | | 0.00 | 0.01 | 0.1 | | 0.12 |
| C-ABD | 0.10 | 10.55 | 0.010 | | 0.00 | 0.01 | 0.1 | | 0.10 |
| EFFECT ON CAPACITY (PCU/MIN) OF MARGINAL CHANGES IN: | | | | | | | | | |
| MARGINAL CHANGE: | LANE WIDTH (.1M) | WIDTH (.1M) | MAJOR RD. WIDTH (.1M) | CENT RES WIDTH (.1M) | VIS TO LEFT (AHEAD FOR MAJOR) (M) | | VISIBILITY TO RIGHT (M) | | |
| B-CD | 0.099 | 0.002 | 0.004 | 0.001 | 0.009 | | | | |
| B-AD | 0.081 | 0.003 | 0.020 | 0.005 | 0.008 | | | | |
| C-ABD | 0.115 | 0.002 | | 0.009 | | | | | |
| D-AB | 0.091 | 0.003 | 0.020 | 0.005 | 0.010 | | | | |
| D-BC | 0.084 | 0.004 | 0.021 | 0.005 | 0.008 | | | | |
| A-BCD | 0.115 | 0.002 | | 0.009 | | | | | |

| I | TIME | DEMAND (VEH/MIN) | CAPACITY (VEH/MIN) | DEMAND/ CAPACITY (RFC) | PEDESTRIAN FLOW (PEDS/MIN) | START QUEUE (VEHS) | END QUEUE (VEHS) | DELAY (VEH.MIN/ TIME SEGMENT) | GEOMETRIC DELAY (VEH.MIN/ TIME SEGMENT) | AVERAGE DELAY PER ARRIVING VEHICLE (MIN) | I | |
|---|-------------|---------------------------------|-----------------------|------------------------------|----------------------------------|--------------------------|------------------------|-------------------------------------|---|--|---|---|
| I | 17.00-17.15 | | | | | | | | | | I | |
| I | B-CD | 2.32 | 10.02 | 0.231 | | 0.23 | 0.30 | 4.4 | | 0.13 | I | |
| I | B-AD | 1.71 | 8.19 | 0.209 | | 0.21 | 0.26 | 3.8 | | 0.15 | I | |
| I | A-BCD | 0.01 | 10.47 | 0.001 | | 0.00 | 0.00 | 0.0 | | 0.10 | I | |
| I | D-AB | 0.05 | 10.79 | 0.005 | | 0.00 | 0.00 | 0.1 | | 0.09 | I | |
| I | D-BC | 0.05 | 8.13 | 0.006 | | 0.01 | 0.01 | 0.1 | | 0.12 | I | |
| I | C-ABD | 0.12 | 10.46 | 0.011 | | 0.01 | 0.01 | 0.2 | | 0.10 | I | |
| I | | | | | | | | | | | I | |
| I | | EFFECT ON CAPACITY (PCU/MIN) OF | | | | | MARGINAL CHANGES IN: | | | | | I |
| I | | | MAJOR RD. | | CENT RES | VIS TO LEFT | | VISIBILITY | | | I | |
| I | MARGINAL | LANE WIDTH | WIDTH | WIDTH | (AHEAD FOR MAJOR) | TO RIGHT | | | | | I | |
| I | CHANGE: | (.1M) | (.1M) | (.1M) | (M) | (M) | | | | | I | |
| I | | | | | | | | | | | I | |
| I | B-CD | 0.097 | 0.003 | 0.004 | 0.001 | 0.009 | | | | | I | |
| I | B-AD | 0.079 | 0.004 | 0.020 | 0.005 | 0.008 | | | | | I | |
| I | C-ABD | 0.114 | 0.003 | | 0.009 | | | | | | I | |
| I | D-AB | 0.090 | 0.004 | 0.020 | 0.005 | 0.010 | | | | | I | |
| I | D-BC | 0.082 | 0.005 | 0.021 | 0.005 | 0.008 | | | | | I | |
| I | A-BCD | 0.114 | 0.003 | | 0.009 | | | | | | I | |

| I | TIME | DEMAND (VEH/MIN) | CAPACITY (VEH/MIN) | DEMAND/ CAPACITY (RFC) | PEDESTRIAN FLOW (PEDS/MIN) | START QUEUE (VEHS) | END QUEUE (VEHS) | DELAY (VEH.MIN/ TIME SEGMENT) | GEOMETRIC DELAY (VEH.MIN/ TIME SEGMENT) | AVERAGE DELAY PER ARRIVING VEHICLE (MIN) | I | |
|---|-------------|---------------------------------|-----------------------|------------------------------|----------------------------------|--------------------------|------------------------|-------------------------------------|---|--|---|---|
| I | 17.15-17.30 | | | | | | | | | | I | |
| I | B-CD | 2.85 | 9.64 | 0.296 | | 0.30 | 0.41 | 6.0 | | 0.15 | I | |
| I | B-AD | 2.09 | 7.96 | 0.262 | | 0.26 | 0.35 | 5.1 | | 0.17 | I | |
| I | A-BCD | 0.02 | 10.34 | 0.002 | | 0.00 | 0.00 | 0.0 | | 0.10 | I | |
| I | D-AB | 0.06 | 10.58 | 0.006 | | 0.00 | 0.01 | 0.1 | | 0.10 | I | |
| I | D-BC | 0.06 | 7.89 | 0.008 | | 0.01 | 0.01 | 0.1 | | 0.13 | I | |
| I | C-ABD | 0.15 | 10.34 | 0.014 | | 0.01 | 0.01 | 0.2 | | 0.10 | I | |
| I | | | | | | | | | | | I | |
| I | | EFFECT ON CAPACITY (PCU/MIN) OF | | | | | MARGINAL CHANGES IN: | | | | | I |
| I | | | MAJOR RD. | | CENT RES | VIS TO LEFT | | VISIBILITY | | | I | |
| I | MARGINAL | LANE WIDTH | WIDTH | WIDTH | (AHEAD FOR MAJOR) | TO RIGHT | | | | | I | |
| I | CHANGE: | (.1M) | (.1M) | (.1M) | (M) | (M) | | | | | I | |
| I | | | | | | | | | | | I | |
| I | B-CD | 0.094 | 0.003 | 0.004 | 0.001 | 0.009 | | | | | I | |
| I | B-AD | 0.077 | 0.005 | 0.020 | 0.005 | 0.008 | | | | | I | |
| I | C-ABD | 0.112 | 0.003 | | 0.009 | | | | | | I | |
| I | D-AB | 0.088 | 0.005 | 0.020 | 0.005 | 0.010 | | | | | I | |
| I | D-BC | 0.079 | 0.006 | 0.021 | 0.005 | 0.007 | | | | | I | |
| I | A-BCD | 0.113 | 0.003 | | 0.009 | | | | | | I | |

| I | TIME | DEMAND (VEH/MIN) | CAPACITY (VEH/MIN) | DEMAND/ CAPACITY (RFC) | PEDESTRIAN FLOW (PEDS/MIN) | START QUEUE (VEHS) | END QUEUE (VEHS) | DELAY (VEH.MIN/ TIME SEGMENT) | GEOMETRIC DELAY (VEH.MIN/ TIME SEGMENT) | AVERAGE DELAY PER ARRIVING VEHICLE (MIN) | I | |
|---|-------------|---------------------------------|-----------------------|------------------------------|----------------------------------|--------------------------|------------------------|-------------------------------------|---|--|---|---|
| I | 17.30-17.45 | | | | | | | | | | I | |
| I | B-CD | 2.85 | 9.63 | 0.296 | | 0.41 | 0.42 | 6.2 | | 0.15 | I | |
| I | B-AD | 2.09 | 7.96 | 0.262 | | 0.35 | 0.35 | 5.3 | | 0.17 | I | |
| I | A-BCD | 0.02 | 10.34 | 0.002 | | 0.00 | 0.00 | 0.0 | | 0.10 | I | |
| I | D-AB | 0.06 | 10.58 | 0.006 | | 0.01 | 0.01 | 0.1 | | 0.10 | I | |
| I | D-BC | 0.06 | 7.89 | 0.008 | | 0.01 | 0.01 | 0.1 | | 0.13 | I | |
| I | C-ABD | 0.15 | 10.34 | 0.014 | | 0.01 | 0.01 | 0.2 | | 0.10 | I | |
| I | | | | | | | | | | | I | |
| I | | EFFECT ON CAPACITY (PCU/MIN) OF | | | | | MARGINAL CHANGES IN: | | | | | I |
| I | | | MAJOR RD. | | CENT RES | VIS TO LEFT | | VISIBILITY | | | I | |
| I | MARGINAL | LANE WIDTH | WIDTH | WIDTH | (AHEAD FOR MAJOR) | TO RIGHT | | | | | I | |
| I | CHANGE: | (.1M) | (.1M) | (.1M) | (M) | (M) | | | | | I | |
| I | | | | | | | | | | | I | |
| I | B-CD | 0.094 | 0.003 | 0.004 | 0.001 | 0.009 | | | | | I | |
| I | B-AD | 0.077 | 0.005 | 0.020 | 0.005 | 0.008 | | | | | I | |
| I | C-ABD | 0.112 | 0.003 | | 0.009 | | | | | | I | |
| I | D-AB | 0.088 | 0.005 | 0.020 | 0.005 | 0.010 | | | | | I | |
| I | D-BC | 0.079 | 0.006 | 0.021 | 0.005 | 0.007 | | | | | I | |
| I | A-BCD | 0.112 | 0.003 | | 0.009 | | | | | | I | |

| TIME | DEMAND (VEH/MIN) | CAPACITY (VEH/MIN) | DEMAND/ CAPACITY (RFC) | PEDESTRIAN FLOW (PEDS/MIN) | START QUEUE (VEHS) | END QUEUE (VEHS) | DELAY (VEH.MIN/ TIME SEGMENT) | GEOMETRIC DELAY (VEH.MIN/ TIME SEGMENT) | AVERAGE DELAY PER ARRIVING VEHICLE (MIN) |
|-------------|---------------------|-----------------------|------------------------------|----------------------------------|--------------------------|------------------------|-------------------------------------|---|--|
| 17.45-18.00 | | | | | | | | | |
| B-CD | 2.32 | 10.02 | 0.231 | | 0.42 | 0.30 | 4.7 | | 0.13 |
| B-AD | 1.71 | 8.19 | 0.209 | | 0.35 | 0.27 | 4.1 | | 0.15 |
| A-BCD | 0.01 | 10.47 | 0.001 | | 0.00 | 0.00 | 0.0 | | 0.10 |
| D-AB | 0.05 | 10.79 | 0.005 | | 0.01 | 0.00 | 0.1 | | 0.09 |
| D-BC | 0.05 | 8.13 | 0.006 | | 0.01 | 0.01 | 0.1 | | 0.12 |
| C-ABD | 0.12 | 10.46 | 0.011 | | 0.01 | 0.01 | 0.2 | | 0.10 |

| MARGINAL CHANGE: | LANE WIDTH (.1M) | CAPACITY WIDTH (.1M) | PEDESTRIAN WIDTH (.1M) | CENT RES WIDTH (.1M) | MARGINAL CHANGES VIS TO LEFT (AHEAD FOR MAJOR) (M) | IN: VISIBILITY TO RIGHT (M) |
|---------------------|---------------------|----------------------------|------------------------------|----------------------------|---|--------------------------------------|
| B-CD | 0.097 | 0.003 | 0.004 | 0.001 | 0.009 | |
| B-AD | 0.079 | 0.004 | 0.020 | 0.005 | 0.008 | |
| C-ABD | 0.114 | 0.003 | | 0.009 | | |
| D-AB | 0.090 | 0.004 | 0.020 | 0.005 | 0.010 | |
| D-BC | 0.082 | 0.005 | 0.021 | 0.005 | 0.008 | |
| A-BCD | 0.114 | 0.003 | | 0.009 | | |

| TIME | DEMAND (VEH/MIN) | CAPACITY (VEH/MIN) | DEMAND/ CAPACITY (RFC) | PEDESTRIAN FLOW (PEDS/MIN) | START QUEUE (VEHS) | END QUEUE (VEHS) | DELAY (VEH.MIN/ TIME SEGMENT) | GEOMETRIC DELAY (VEH.MIN/ TIME SEGMENT) | AVERAGE DELAY PER ARRIVING VEHICLE (MIN) |
|-------------|---------------------|-----------------------|------------------------------|----------------------------------|--------------------------|------------------------|-------------------------------------|---|--|
| 18.00-18.15 | | | | | | | | | |
| B-CD | 1.93 | 10.27 | 0.188 | | 0.30 | 0.23 | 3.6 | | 0.12 |
| B-AD | 1.44 | 8.35 | 0.173 | | 0.27 | 0.21 | 3.2 | | 0.14 |
| A-BCD | 0.01 | 10.55 | 0.001 | | 0.00 | 0.00 | 0.0 | | 0.09 |
| D-AB | 0.04 | 10.94 | 0.004 | | 0.00 | 0.00 | 0.1 | | 0.09 |
| D-BC | 0.04 | 8.31 | 0.005 | | 0.01 | 0.01 | 0.1 | | 0.12 |
| C-ABD | 0.10 | 10.55 | 0.010 | | 0.01 | 0.01 | 0.1 | | 0.10 |

| MARGINAL CHANGE: | LANE WIDTH (.1M) | CAPACITY WIDTH (.1M) | PEDESTRIAN WIDTH (.1M) | CENT RES WIDTH (.1M) | MARGINAL CHANGES VIS TO LEFT (AHEAD FOR MAJOR) (M) | IN: VISIBILITY TO RIGHT (M) |
|---------------------|---------------------|----------------------------|------------------------------|----------------------------|---|--------------------------------------|
| B-CD | 0.099 | 0.002 | 0.004 | 0.001 | 0.009 | |
| B-AD | 0.081 | 0.003 | 0.020 | 0.005 | 0.008 | |
| C-ABD | 0.115 | 0.002 | | 0.009 | | |
| D-AB | 0.091 | 0.003 | 0.020 | 0.005 | 0.010 | |
| D-BC | 0.084 | 0.004 | 0.021 | 0.005 | 0.008 | |
| A-BCD | 0.115 | 0.002 | | 0.009 | | |

QUEUE FOR STREAM B-CD

| TIME SEGMENT ENDING | NO. OF VEHICLES IN QUEUE |
|------------------------|--------------------------------|
| 17.00 | 0.2 |
| 17.15 | 0.3 |
| 17.30 | 0.4 |
| 17.45 | 0.4 |
| 18.00 | 0.3 |
| 18.15 | 0.2 |

QUEUE FOR STREAM B-AD

| TIME SEGMENT ENDING | NO. OF VEHICLES IN QUEUE |
|------------------------|--------------------------------|
| 17.00 | 0.2 |
| 17.15 | 0.3 |
| 17.30 | 0.3 |
| 17.45 | 0.4 |
| 18.00 | 0.3 |
| 18.15 | 0.2 |

QUEUE FOR STREAM A-BCD

| TIME SEGMENT ENDING | NO. OF VEHICLES IN QUEUE |
|------------------------|--------------------------------|
| 17.00 | 0.0 |
| 17.15 | 0.0 |
| 17.30 | 0.0 |
| 17.45 | 0.0 |
| 18.00 | 0.0 |
| 18.15 | 0.0 |

```

QUEUE FOR STREAM D-AB
XXXXXXXXXXXXXXXXXXXXXXXXXXXXXXXXXXXX
TIME SEGMENT NO. OF
ENDING VEHICLES
IN QUEUE
17.00 0.0
17.15 0.0
17.30 0.0
17.45 0.0
18.00 0.0
18.15 0.0

```

```

QUEUE FOR STREAM D-BC
XXXXXXXXXXXXXXXXXXXXXXXXXXXXXXXXXXXX
TIME SEGMENT NO. OF
ENDING VEHICLES
IN QUEUE
17.00 0.0
17.15 0.0
17.30 0.0
17.45 0.0
18.00 0.0
18.15 0.0

```

```

QUEUE FOR STREAM C-ABD
XXXXXXXXXXXXXXXXXXXXXXXXXXXXXXXXXXXX
TIME SEGMENT NO. OF
ENDING VEHICLES
IN QUEUE
17.00 0.0
17.15 0.0
17.30 0.0
17.45 0.0
18.00 0.0
18.15 0.0

```

QUEUEING DELAY INFORMATION OVER WHOLE PERIOD

```

XXXXXXXXXXXXXXXXXXXXXXXXXXXXXXXXXXXX
I STREAM I TOTAL DEMAND I * QUEUEING * I * INCLUSIVE QUEUEING * I
I I I * DELAY * I * DELAY * I
I I
I I (VEH) (VEH/H) I (MIN) (MIN/VEH) I (MIN) (MIN/VEH) I
XXXXXXXXXXXXXXXXXXXXXXXXXXXXXXXXXXXX
I B-CD I 213.1 I 142.0 I 28.2 I 0.13 I 28.2 I 0.13 I
I B-AD I 157.2 I 104.8 I 24.5 I 0.16 I 24.5 I 0.16 I
I A-BCD I 1.4 I 0.9 I 0.1 I 0.09 I 0.1 I 0.09 I
I D-AB I 4.8 I 3.2 I 0.4 I 0.09 I 0.4 I 0.09 I
I D-BC I 4.8 I 3.2 I 0.6 I 0.12 I 0.6 I 0.12 I
I C-ABD I 11.0 I 7.3 I 1.1 I 0.10 I 1.1 I 0.10 I
XXXXXXXXXXXXXXXXXXXXXXXXXXXXXXXXXXXX
I ALL I 787.3 I 524.9 I 55.0 I 0.07 I 55.0 I 0.07 I
XXXXXXXXXXXXXXXXXXXXXXXXXXXXXXXXXXXX

```

* DELAY IS THAT OCCURRING ONLY WITHIN THE TIME PERIOD .
* INCLUSIVE DELAY INCLUDES DELAY SUFFERED BY VEHICLES WHICH ARE STILL QUEUEING AFTER THE END OF THE TIME PERIOD.
* THESE WILL ONLY BE SIGNIFICANTLY DIFFERENT IF THERE IS A LARGE QUEUE REMAINING AT THE END OF THE TIME PERIOD.

END OF JOB

===== end of file =====

TRL LIMITED

(C) COPYRIGHT 2006

CAPACITIES, QUEUES, AND DELAYS AT 3 OR 4-ARM MAJOR/MINOR PRIORITY JUNCTIONS

PICADY 5.0 ANALYSIS PROGRAM
RELEASE 3.0 (JUNE 2006)

ADAPTED FROM PICADY/3 WHICH IS CROWN COPYRIGHT
BY PERMISSION OF THE CONTROLLER OF HMSO

FOR SALES AND DISTRIBUTION INFORMATION,
PROGRAM ADVICE AND MAINTENANCE CONTACT:
TRL SOFTWARE BUREAU
TEL: CROWTHORNE (01344) 770758, FAX: 770864
EMAIL: SoftwareBureau@trl.co.uk

THE USER OF THIS COMPUTER PROGRAM FOR THE SOLUTION OF AN ENGINEERING PROBLEM IS
IN NO WAY RELIEVED OF HIS RESPONSIBILITY FOR THE CORRECTNESS OF THE SOLUTION

Run with file:-

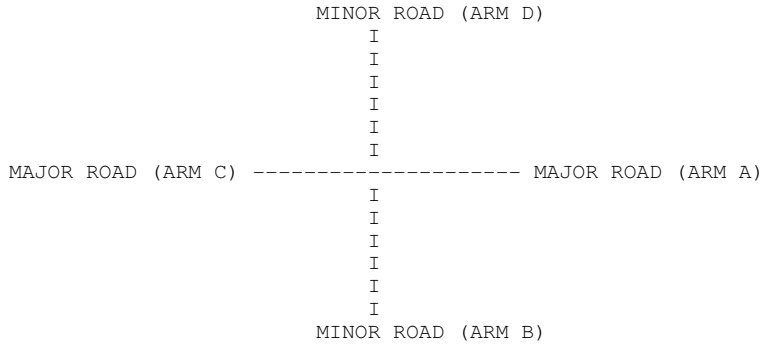
"J:\120000\120669-00\4 Internal Project Data\4-04 Calculations\4-04-06 Junction Analysis\Picady\
Site 4. B4030 Lower Heyford Rd - Port Way\2013 Base\AM\Site 4.Lower Heyford - Port Way 2013 Base AM.vpi"
(drive-on-the-left) at 09:01:20 on Wednesday, 11 July 2007

RUN INFORMATION

RUN TITLE: Site 4. Lower Heyford Rd - Port Way 2013 Base AM
LOCATION: Oxfordshire
DATE: 06/12/06
CLIENT: North Oxfordshire Consortium
ENUMERATOR: chris.morris [MCCPC062011]
JOB NUMBER: 120669
STATUS: TIA
DESCRIPTION:

.MAJOR/MINOR JUNCTION CAPACITY AND DELAY

INPUT DATA



ARM A IS Lower Heyford Road (E)
ARM B IS Port Way (S)
ARM C IS Lower Heyford Road (W)
ARM D IS Port Way (N)

STREAM LABELLING CONVENTION

STREAM A-B CONTAINS TRAFFIC GOING FROM ARM A TO ARM B
STREAM B-AC CONTAINS TRAFFIC GOING FROM ARM B TO ARM A AND TO ARM C
ETC.

 GEOMETRIC DATA

| I | DATA ITEM | I | MINOR ROAD B | I | MINOR ROAD D | I |
|---|------------------------------------|---|-----------------|---|-----------------|---|
| I | TOTAL MAJOR ROAD CARRIAGEWAY WIDTH | I | (W) 7.00 M. | I | (W) 7.00 M. | I |
| I | CENTRAL RESERVE WIDTH | I | (WCR) 0.00 M. | I | (WCR) 0.00 M. | I |
| I | | I | | I | | I |
| I | MAJOR ROAD RIGHT TURN - WIDTH | I | (WC-B) 2.20 M. | I | (WA-D) 2.20 M. | I |
| I | - VISIBILITY | I | (VC-B) 150.0 M. | I | (VA-D) 150.0 M. | I |
| I | - BLOCKS TRAFFIC | I | YES | I | YES | I |
| I | | I | | I | | I |
| I | MINOR ROAD - VISIBILITY TO LEFT | I | (VB-C) 38.0 M. | I | (VD-A) 95.0 M. | I |
| I | - VISIBILITY TO RIGHT | I | (VB-A) 72.0 M. | I | (VD-C) 92.0 M. | I |
| I | - LANE 1 WIDTH | I | (WB-C) - | I | (WD-A) - | I |
| I | - LANE 2 WIDTH | I | (WB-A) - | I | (WD-C) - | I |
| I | - WIDTH AT 0 M FROM JUNC. | I | 10.00 M. | I | 10.00 M. | I |
| I | - WIDTH AT 5 M FROM JUNC. | I | 6.00 M. | I | 8.00 M. | I |
| I | - WIDTH AT 10 M FROM JUNC. | I | 4.50 M. | I | 5.80 M. | I |
| I | - WIDTH AT 15 M FROM JUNC. | I | 4.10 M. | I | 4.00 M. | I |
| I | - WIDTH AT 20 M FROM JUNC. | I | 3.70 M. | I | 3.20 M. | I |
| I | - LENGTH OF FLARED SECTION | I | DERIVED: 1 PCU | I | 2 VEHS | I |

.SLOPES AND INTERCPET

(NB:Streams may be combined, in which case capacity will be adjusted)

B-C Stream

| I | Intercept For Stream B-C | Slope For Opposing Stream A-C | Slope For Opposing Stream A-B | I |
|---|--------------------------|-------------------------------|-------------------------------|---|
| I | 615.66 | 0.23 | 0.09 | I |

D-A Stream

| I | Intercept For Stream D-A | Slope For Opposing Stream C-A | Slope For Opposing Stream C-D | I |
|---|--------------------------|-------------------------------|-------------------------------|---|
| I | 627.24 | 0.23 | 0.09 | I |

B-A Stream

| I | Intercept For Stream B-A | Slope For Opposing Stream A-C | Slope For Opposing Stream A-D | Slope For Opposing Stream D-A | Slope For Opposing Stream D-B | I |
|---|--------------------------|-------------------------------|-------------------------------|-------------------------------|-------------------------------|---|
| I | 483.33 | 0.21 | 0.21 | 0.21 | 0.21 | I |

| I | Slope For Opposing Stream A-B | Slope For Opposing Stream C-A | Slope For Opposing Stream C-B | Slope For Opposing Stream D-C | I |
|---|-------------------------------|-------------------------------|-------------------------------|-------------------------------|---|
| I | 0.08 | 0.13 | 0.30 | 0.11 | I |

D-C Stream

| I | Intercept For Stream D-C | Slope For Opposing Stream C-A | Slope For Opposing Stream C-B | Slope For Opposing Stream B-C | Slope For Opposing Stream B-D | I |
|---|--------------------------|-------------------------------|-------------------------------|-------------------------------|-------------------------------|---|
| I | 510.47 | 0.22 | 0.22 | 0.22 | 0.22 | I |

| I | Slope For Opposing Stream C-D | Slope For Opposing Stream A-C | Slope For Opposing Stream A-D | Slope For Opposing Stream B-A | I |
|---|-------------------------------|-------------------------------|-------------------------------|-------------------------------|---|
| I | 0.09 | 0.14 | 0.32 | 0.11 | I |

C-B Stream

| I | Intercept For Stream C-B | Slope For Opposing Stream A-C | Slope For Opposing Stream A-D | I |
|---|--------------------------|-------------------------------|-------------------------------|---|
| I | 660.83 | 0.24 | 0.35 | I |

A-D Stream

| I | Intercept For Stream A-D | Slope For Opposing Stream C-A | Slope For Opposing Stream C-B | I |
|---|--------------------------|-------------------------------|-------------------------------|---|
| I | 660.83 | 0.24 | 0.35 | I |

B-D Stream From Left Hand Lane

| I | Intercept For Stream B-D | Slope For Opposing Stream A-C | Slope For Opposing Stream A-D | Slope For Opposing Stream A-B | Slope For Opposing Stream C-B | I |
|---|--------------------------|-------------------------------|-------------------------------|-------------------------------|-------------------------------|---|
| I | 483.33 | 0.21 | 0.21 | 0.08 | 0.30 | I |

| I | Slope For Opposing Stream C-A | Slope For Opposing Stream C-D | Slope For Opposing Stream C-B | I |
|---|-------------------------------|-------------------------------|-------------------------------|---|
| I | 0.13 | 0.13 | | I |

B-D Stream From Right Hand Lane

| I | Intercept For Stream B-D | Slope For Opposing Stream A-C | Slope For Opposing Stream A-D | Slope For Opposing Stream A-B | Slope For Opposing Stream C-B | I |
|---|--------------------------|-------------------------------|-------------------------------|-------------------------------|-------------------------------|---|
| I | 483.33 | 0.21 | 0.21 | 0.08 | 0.30 | I |

| I | Slope For Opposing Stream C-A | Slope For Opposing Stream C-D | Slope For Opposing Stream C-B | I |
|---|-------------------------------|-------------------------------|-------------------------------|---|
| I | 0.13 | 0.13 | | I |

D-B Stream From Left Hand Lane

| I | Intercept For Stream D-B | Slope For Opposing Stream C-A | Slope For Opposing Stream C-B | Slope For Opposing Stream D-C | Slope For Opposing Stream A-D | I |
|---|--------------------------|-------------------------------|-------------------------------|-------------------------------|-------------------------------|---|
| I | 510.47 | 0.22 | 0.22 | 0.09 | 0.32 | I |

| I | Slope For Opposing Stream A-C | Slope For Opposing Stream A-B | Slope For Opposing Stream C-B | I |
|---|-------------------------------|-------------------------------|-------------------------------|---|
| I | 0.14 | 0.14 | | I |

D-B Stream From Right Hand Lane

| I | Intercept For Stream D-B | Slope For Opposing Stream C-A | Slope For Opposing Stream C-B | Slope For Opposing Stream C-D | Slope For Opposing Stream A-D | I |
|---|--------------------------|-------------------------------|-------------------------------|-------------------------------|-------------------------------|---|
| I | 510.47 | 0.22 | 0.22 | 0.09 | 0.32 | I |

| I | Slope For Opposing Stream A-C | Slope For Opposing Stream A-B | Slope For Opposing Stream C-B | I |
|---|-------------------------------|-------------------------------|-------------------------------|---|
| I | 0.14 | 0.14 | | I |

TRAFFIC DEMAND DATA

| ARM | FLOW SCALE (%) |
|-----|----------------|
| A | 100 |
| B | 100 |
| C | 100 |
| D | 100 |

Demand set: Site 4. Lower Heyford Rd - Port Way 2013 Base AM

TIME PERIOD BEGINS 07.45 AND ENDS 09.15

LENGTH OF TIME PERIOD - 90 MINUTES.
 LENGTH OF TIME SEGMENT - 15 MINUTES.

DEMAND FLOW PROFILES ARE SYNTHESISED FROM TURNING COUNT DATA

| ARM | NUMBER OF MINUTES FROM START WHEN FLOW STARTS TO RISE | TOP OF PEAK IS REACHED | FLOW STOPS FALLING | RATE OF FLOW (VEH/MIN) BEFORE PEAK | AT TOP OF PEAK | AFTER PEAK |
|-------|---|------------------------|--------------------|------------------------------------|----------------|------------|
| ARM A | 15.00 | 45.00 | 75.00 | 1.90 | 2.85 | 1.90 |
| ARM B | 15.00 | 45.00 | 75.00 | 1.02 | 1.54 | 1.02 |
| ARM C | 15.00 | 45.00 | 75.00 | 2.89 | 4.33 | 2.89 |
| ARM D | 15.00 | 45.00 | 75.00 | 0.30 | 0.45 | 0.30 |

| TIME | TURNING PROPORTIONS | | | | |
|---------------|---------------------|--------|--------|--------|--------|
| | FROM/TO | ARM A | ARM B | ARM C | ARM D |
| 07.45 - 09.15 | ARM A | 0.000 | 0.105 | 0.895 | 0.000 |
| | | (0.0) | (0.0) | (0.0) | (0.0) |
| | ARM B | 0.537 | 0.000 | 0.415 | 0.049 |
| | | 44.0 | 0.0 | 34.0 | 4.0 |
| | | (0.0) | (0.0) | (0.0) | (0.0) |
| | ARM C | 0.762 | 0.238 | 0.000 | 0.000 |
| | | 176.0 | 55.0 | 0.0 | 0.0 |
| | | (0.0) | (0.0) | (0.0) | (0.0) |
| | ARM D | 0.083 | 0.833 | 0.083 | 0.000 |
| | | 2.0 | 20.0 | 2.0 | 0.0 |
| | | (0.0) | (0.0) | (0.0) | (0.0) |

TURNING PROPORTIONS ARE CALCULATED FROM TURNING COUNT DATA

QUEUE AND DELAY INFORMATION FOR EACH 15 MIN TIME SEGMENT

FOR COMBINED DEMAND SETS
 AND FOR TIME PERIOD 1

| TIME | DEMAND (VEH/MIN) | CAPACITY (VEH/MIN) | DEMAND/CAPACITY (RFC) | PEDESTRIAN FLOW (PEDS/MIN) | START QUEUE (VEHS) | END QUEUE (VEHS) | DELAY (VEH.MIN/TIME SEGMENT) | GEOMETRIC DELAY (VEH.MIN/TIME SEGMENT) | AVERAGE DELAY PER ARRIVING VEHICLE (MIN) |
|--|------------------|--------------------|-----------------------|----------------------------|-----------------------------------|-------------------------|------------------------------|--|--|
| 07.45-08.00 | | | | | | | | | |
| B-CD | 0.45 | 10.59 | 0.043 | | 0.00 | 0.04 | 0.6 | | 0.10 |
| B-AD | 0.58 | 8.15 | 0.071 | | 0.00 | 0.08 | 1.1 | | 0.13 |
| A-BCD | 0.00 | 9.30 | 0.000 | | 0.00 | 0.00 | 0.0 | | 0.00 |
| D-AB | 0.15 | 10.26 | 0.015 | | 0.00 | 0.01 | 0.2 | | 0.10 |
| D-BC | 0.15 | 8.17 | 0.018 | | 0.00 | 0.02 | 0.3 | | 0.12 |
| C-ABD | 0.69 | 10.55 | 0.065 | | 0.00 | 0.07 | 1.0 | | 0.10 |
| EFFECT ON CAPACITY (PCU/MIN) OF MARGINAL CHANGES IN: | | | | | | | | | |
| MARGINAL CHANGE: | LANE WIDTH (.1M) | WIDTH (.1M) | MAJOR RD. WIDTH (.1M) | CENT RES WIDTH (.1M) | VIS TO LEFT (AHEAD FOR MAJOR) (M) | VISIBILITY TO RIGHT (M) | | | |
| B-CD | 0.103 | 0.002 | 0.002 | 0.002 | 0.001 | 0.010 | | | |
| B-AD | 0.077 | 0.005 | 0.021 | 0.005 | 0.008 | | | | |
| C-ABD | 0.115 | 0.002 | | 0.009 | | | | | |
| D-AB | 0.086 | 0.005 | 0.022 | 0.006 | 0.009 | | | | |
| D-BC | 0.082 | 0.005 | 0.021 | 0.005 | 0.008 | | | | |
| A-BCD | 0.111 | 0.004 | | 0.009 | | | | | |

| I | TIME | DEMAND (VEH/MIN) | CAPACITY (VEH/MIN) | DEMAND/ CAPACITY (RFC) | PEDESTRIAN FLOW (PEDS/MIN) | START QUEUE (VEHS) | END QUEUE (VEHS) | DELAY (VEH.MIN/ TIME SEGMENT) | GEOMETRIC DELAY (VEH.MIN/ TIME SEGMENT) | AVERAGE DELAY PER ARRIVING VEHICLE (MIN) | I | |
|---|-------------|---------------------------------|-----------------------|------------------------------|----------------------------------|----------------------------------|------------------------|-------------------------------------|---|--|---|---|
| I | 08.00-08.15 | | | | | | | | | | I | |
| I | B-CD | 0.54 | 10.44 | 0.052 | | 0.04 | 0.05 | 0.8 | | 0.10 | I | |
| I | B-AD | 0.69 | 7.94 | 0.087 | | 0.08 | 0.09 | 1.4 | | 0.14 | I | |
| I | A-BCD | 0.00 | 9.16 | 0.000 | | 0.00 | 0.00 | 0.0 | | 0.00 | I | |
| I | D-AB | 0.18 | 10.02 | 0.018 | | 0.01 | 0.02 | 0.3 | | 0.10 | I | |
| I | D-BC | 0.18 | 7.97 | 0.022 | | 0.02 | 0.02 | 0.3 | | 0.13 | I | |
| I | C-ABD | 0.82 | 10.46 | 0.079 | | 0.07 | 0.09 | 1.3 | | 0.10 | I | |
| I | | | | | | | | | | | I | |
| I | | EFFECT ON CAPACITY (PCU/MIN) OF | | | | | MARGINAL CHANGES IN: | | | | | I |
| I | | MARGINAL | LANE WIDTH | MAJOR RD. WIDTH | CENT RES WIDTH | VIS TO LEFT (AHEAD FOR MAJOR) | | VISIBILITY TO RIGHT | | | I | |
| I | | CHANGE: | (.1M) | (.1M) | (.1M) | (M) | | (M) | | | I | |
| I | | | | | | | | | | | I | |
| I | B-CD | | 0.102 | 0.003 | 0.002 | 0.001 | | 0.010 | | | I | |
| I | B-AD | | 0.075 | 0.006 | 0.021 | 0.005 | | 0.007 | | | I | |
| I | C-ABD | | 0.114 | 0.003 | | 0.009 | | | | | I | |
| I | D-AB | | 0.084 | 0.006 | 0.022 | 0.005 | | 0.009 | | | I | |
| I | D-BC | | 0.080 | 0.006 | 0.021 | 0.005 | | 0.007 | | | I | |
| I | A-BCD | | 0.110 | 0.004 | | 0.009 | | | | | I | |

| I | TIME | DEMAND (VEH/MIN) | CAPACITY (VEH/MIN) | DEMAND/ CAPACITY (RFC) | PEDESTRIAN FLOW (PEDS/MIN) | START QUEUE (VEHS) | END QUEUE (VEHS) | DELAY (VEH.MIN/ TIME SEGMENT) | GEOMETRIC DELAY (VEH.MIN/ TIME SEGMENT) | AVERAGE DELAY PER ARRIVING VEHICLE (MIN) | I | |
|---|-------------|---------------------------------|-----------------------|------------------------------|----------------------------------|----------------------------------|------------------------|-------------------------------------|---|--|---|---|
| I | 08.15-08.30 | | | | | | | | | | I | |
| I | B-CD | 0.66 | 10.23 | 0.065 | | 0.05 | 0.07 | 1.0 | | 0.10 | I | |
| I | B-AD | 0.84 | 7.64 | 0.110 | | 0.09 | 0.12 | 1.8 | | 0.15 | I | |
| I | A-BCD | 0.00 | 8.97 | 0.000 | | 0.00 | 0.00 | 0.0 | | 0.00 | I | |
| I | D-AB | 0.22 | 9.70 | 0.023 | | 0.02 | 0.02 | 0.3 | | 0.11 | I | |
| I | D-BC | 0.22 | 7.69 | 0.029 | | 0.02 | 0.03 | 0.4 | | 0.13 | I | |
| I | C-ABD | 1.01 | 10.33 | 0.098 | | 0.09 | 0.11 | 1.7 | | 0.11 | I | |
| I | | | | | | | | | | | I | |
| I | | EFFECT ON CAPACITY (PCU/MIN) OF | | | | | MARGINAL CHANGES IN: | | | | | I |
| I | | MARGINAL | LANE WIDTH | MAJOR RD. WIDTH | CENT RES WIDTH | VIS TO LEFT (AHEAD FOR MAJOR) | | VISIBILITY TO RIGHT | | | I | |
| I | | CHANGE: | (.1M) | (.1M) | (.1M) | (M) | | (M) | | | I | |
| I | | | | | | | | | | | I | |
| I | B-CD | | 0.100 | 0.003 | 0.002 | 0.001 | | 0.009 | | | I | |
| I | B-AD | | 0.073 | 0.007 | 0.021 | 0.005 | | 0.007 | | | I | |
| I | C-ABD | | 0.112 | 0.003 | | 0.009 | | | | | I | |
| I | D-AB | | 0.081 | 0.008 | 0.023 | 0.005 | | 0.009 | | | I | |
| I | D-BC | | 0.077 | 0.007 | 0.021 | 0.005 | | 0.007 | | | I | |
| I | A-BCD | | 0.107 | 0.005 | | 0.009 | | | | | I | |

| I | TIME | DEMAND (VEH/MIN) | CAPACITY (VEH/MIN) | DEMAND/ CAPACITY (RFC) | PEDESTRIAN FLOW (PEDS/MIN) | START QUEUE (VEHS) | END QUEUE (VEHS) | DELAY (VEH.MIN/ TIME SEGMENT) | GEOMETRIC DELAY (VEH.MIN/ TIME SEGMENT) | AVERAGE DELAY PER ARRIVING VEHICLE (MIN) | I | |
|---|-------------|---------------------------------|-----------------------|------------------------------|----------------------------------|----------------------------------|------------------------|-------------------------------------|---|--|---|---|
| I | 08.30-08.45 | | | | | | | | | | I | |
| I | B-CD | 0.66 | 10.23 | 0.065 | | 0.07 | 0.07 | 1.0 | | 0.10 | I | |
| I | B-AD | 0.84 | 7.64 | 0.110 | | 0.12 | 0.12 | 1.8 | | 0.15 | I | |
| I | A-BCD | 0.00 | 8.97 | 0.000 | | 0.00 | 0.00 | 0.0 | | 0.00 | I | |
| I | D-AB | 0.22 | 9.70 | 0.023 | | 0.02 | 0.02 | 0.3 | | 0.11 | I | |
| I | D-BC | 0.22 | 7.69 | 0.029 | | 0.03 | 0.03 | 0.4 | | 0.13 | I | |
| I | C-ABD | 1.01 | 10.33 | 0.098 | | 0.11 | 0.11 | 1.7 | | 0.11 | I | |
| I | | | | | | | | | | | I | |
| I | | EFFECT ON CAPACITY (PCU/MIN) OF | | | | | MARGINAL CHANGES IN: | | | | | I |
| I | | MARGINAL | LANE WIDTH | MAJOR RD. WIDTH | CENT RES WIDTH | VIS TO LEFT (AHEAD FOR MAJOR) | | VISIBILITY TO RIGHT | | | I | |
| I | | CHANGE: | (.1M) | (.1M) | (.1M) | (M) | | (M) | | | I | |
| I | | | | | | | | | | | I | |
| I | B-CD | | 0.100 | 0.003 | 0.002 | 0.001 | | 0.009 | | | I | |
| I | B-AD | | 0.073 | 0.007 | 0.021 | 0.005 | | 0.007 | | | I | |
| I | C-ABD | | 0.112 | 0.003 | | 0.009 | | | | | I | |
| I | D-AB | | 0.081 | 0.008 | 0.023 | 0.005 | | 0.009 | | | I | |
| I | D-BC | | 0.077 | 0.007 | 0.021 | 0.005 | | 0.007 | | | I | |
| I | A-BCD | | 0.107 | 0.005 | | 0.009 | | | | | I | |

| I | TIME | DEMAND (VEH/MIN) | CAPACITY (VEH/MIN) | DEMAND/ CAPACITY (RFC) | PEDESTRIAN FLOW (PEDS/MIN) | START QUEUE (VEHS) | END QUEUE (VEHS) | DELAY (VEH.MIN/ TIME SEGMENT) | GEOMETRIC DELAY (VEH.MIN/ TIME SEGMENT) | AVERAGE DELAY PER ARRIVING VEHICLE (MIN) | I | |
|---|-------------|--|-----------------------|------------------------------|----------------------------------|--------------------------|------------------------|-------------------------------------|---|--|---|---|
| I | 08.45-09.00 | | | | | | | | | | I | |
| I | B-CD | 0.54 | 10.44 | 0.052 | | 0.07 | 0.06 | 0.8 | | 0.10 | I | |
| I | B-AD | 0.69 | 7.94 | 0.087 | | 0.12 | 0.10 | 1.5 | | 0.14 | I | |
| I | A-BCD | 0.00 | 9.16 | 0.000 | | 0.00 | 0.00 | 0.0 | | 0.00 | I | |
| I | D-AB | 0.18 | 10.02 | 0.018 | | 0.02 | 0.02 | 0.3 | | 0.10 | I | |
| I | D-BC | 0.18 | 7.97 | 0.022 | | 0.03 | 0.02 | 0.4 | | 0.13 | I | |
| I | C-ABD | 0.82 | 10.46 | 0.079 | | 0.11 | 0.09 | 1.3 | | 0.10 | I | |
| I | | | | | | | | | | | I | |
| I | | EFFECT ON CAPACITY (PCU/MIN) OF MARGINAL CHANGES IN: | | | | | | | | | | I |
| I | | | MAJOR RD. | CENT RES | VIS TO LEFT | VISIBILITY | | | | | I | |
| I | MARGINAL | LANE WIDTH | WIDTH | WIDTH | (AHEAD FOR MAJOR) | TO RIGHT | | | | | I | |
| I | CHANGE: | (.1M) | (.1M) | (.1M) | (M) | (M) | | | | | I | |
| I | | | | | | | | | | | I | |
| I | B-CD | 0.102 | 0.003 | 0.002 | 0.001 | 0.010 | | | | | I | |
| I | B-AD | 0.075 | 0.006 | 0.021 | 0.005 | 0.007 | | | | | I | |
| I | C-ABD | 0.114 | 0.003 | | 0.009 | | | | | | I | |
| I | D-AB | 0.084 | 0.006 | 0.022 | 0.005 | 0.009 | | | | | I | |
| I | D-BC | 0.080 | 0.006 | 0.021 | 0.005 | 0.007 | | | | | I | |
| I | A-BCD | 0.110 | 0.004 | | 0.009 | | | | | | I | |

| I | TIME | DEMAND (VEH/MIN) | CAPACITY (VEH/MIN) | DEMAND/ CAPACITY (RFC) | PEDESTRIAN FLOW (PEDS/MIN) | START QUEUE (VEHS) | END QUEUE (VEHS) | DELAY (VEH.MIN/ TIME SEGMENT) | GEOMETRIC DELAY (VEH.MIN/ TIME SEGMENT) | AVERAGE DELAY PER ARRIVING VEHICLE (MIN) | I | |
|---|-------------|--|-----------------------|------------------------------|----------------------------------|--------------------------|------------------------|-------------------------------------|---|--|---|---|
| I | 09.00-09.15 | | | | | | | | | | I | |
| I | B-CD | 0.45 | 10.59 | 0.043 | | 0.06 | 0.05 | 0.7 | | 0.10 | I | |
| I | B-AD | 0.58 | 8.15 | 0.071 | | 0.10 | 0.08 | 1.2 | | 0.13 | I | |
| I | A-BCD | 0.00 | 9.30 | 0.000 | | 0.00 | 0.00 | 0.0 | | 0.00 | I | |
| I | D-AB | 0.15 | 10.25 | 0.015 | | 0.02 | 0.02 | 0.2 | | 0.10 | I | |
| I | D-BC | 0.15 | 8.16 | 0.018 | | 0.02 | 0.02 | 0.3 | | 0.12 | I | |
| I | C-ABD | 0.69 | 10.55 | 0.065 | | 0.09 | 0.07 | 1.1 | | 0.10 | I | |
| I | | | | | | | | | | | I | |
| I | | EFFECT ON CAPACITY (PCU/MIN) OF MARGINAL CHANGES IN: | | | | | | | | | | I |
| I | | | MAJOR RD. | CENT RES | VIS TO LEFT | VISIBILITY | | | | | I | |
| I | MARGINAL | LANE WIDTH | WIDTH | WIDTH | (AHEAD FOR MAJOR) | TO RIGHT | | | | | I | |
| I | CHANGE: | (.1M) | (.1M) | (.1M) | (M) | (M) | | | | | I | |
| I | | | | | | | | | | | I | |
| I | B-CD | 0.103 | 0.002 | 0.002 | 0.001 | 0.010 | | | | | I | |
| I | B-AD | 0.077 | 0.005 | 0.021 | 0.005 | 0.008 | | | | | I | |
| I | C-ABD | 0.115 | 0.002 | | 0.009 | | | | | | I | |
| I | D-AB | 0.085 | 0.005 | 0.022 | 0.006 | 0.009 | | | | | I | |
| I | D-BC | 0.082 | 0.005 | 0.021 | 0.005 | 0.008 | | | | | I | |
| I | A-BCD | 0.111 | 0.004 | | 0.009 | | | | | | I | |

QUEUE FOR STREAM B-CD

| TIME SEGMENT ENDING | NO. OF VEHICLES IN QUEUE |
|------------------------|--------------------------------|
| 08.00 | 0.0 |
| 08.15 | 0.1 |
| 08.30 | 0.1 |
| 08.45 | 0.1 |
| 09.00 | 0.1 |
| 09.15 | 0.0 |

QUEUE FOR STREAM B-AD

| TIME SEGMENT ENDING | NO. OF VEHICLES IN QUEUE |
|------------------------|--------------------------------|
| 08.00 | 0.1 |
| 08.15 | 0.1 |
| 08.30 | 0.1 |
| 08.45 | 0.1 |
| 09.00 | 0.1 |
| 09.15 | 0.1 |

QUEUE FOR STREAM A-BCD

| TIME SEGMENT ENDING | NO. OF VEHICLES IN QUEUE |
|------------------------|--------------------------------|
| 08.00 | 0.0 |
| 08.15 | 0.0 |
| 08.30 | 0.0 |
| 08.45 | 0.0 |
| 09.00 | 0.0 |
| 09.15 | 0.0 |

QUEUE FOR STREAM D-AB

| TIME SEGMENT ENDING | NO. OF VEHICLES IN QUEUE |
|------------------------|--------------------------------|
| 08.00 | 0.0 |
| 08.15 | 0.0 |
| 08.30 | 0.0 |
| 08.45 | 0.0 |
| 09.00 | 0.0 |
| 09.15 | 0.0 |

QUEUE FOR STREAM D-BC

| TIME SEGMENT ENDING | NO. OF VEHICLES IN QUEUE |
|------------------------|--------------------------------|
| 08.00 | 0.0 |
| 08.15 | 0.0 |
| 08.30 | 0.0 |
| 08.45 | 0.0 |
| 09.00 | 0.0 |
| 09.15 | 0.0 |

QUEUE FOR STREAM C-ABD

| TIME SEGMENT ENDING | NO. OF VEHICLES IN QUEUE |
|------------------------|--------------------------------|
| 08.00 | 0.1 |
| 08.15 | 0.1 |
| 08.30 | 0.1 |
| 08.45 | 0.1 |
| 09.00 | 0.1 |
| 09.15 | 0.1 |

QUEUEING DELAY INFORMATION OVER WHOLE PERIOD

| I | STREAM | I | TOTAL DEMAND | I | * QUEUEING * | I | * INCLUSIVE QUEUEING * | I | | |
|---|--------|-------|--------------|---|--------------|-----------|------------------------|-------|-----------|---|
| I | I | I | I | I | * DELAY * | I | * DELAY * | I | | |
| I | I | I | I | I | I | I | I | I | | |
| I | I | (VEH) | (VEH/H) | I | (MIN) | (MIN/VEH) | I | (MIN) | (MIN/VEH) | I |
| I | B-CD | I | 49.8 | I | 33.2 | I | 5.0 | I | 0.10 | I |
| I | B-AD | I | 63.1 | I | 42.0 | I | 8.7 | I | 0.14 | I |
| I | A-BCD | I | 0.0 | I | 0.0 | I | 0.0 | I | 0.00 | I |
| I | D-AB | I | 16.6 | I | 11.0 | I | 1.7 | I | 0.10 | I |
| I | D-BC | I | 16.5 | I | 11.0 | I | 2.1 | I | 0.13 | I |
| I | C-ABD | I | 75.7 | I | 50.5 | I | 8.1 | I | 0.11 | I |
| I | ALL | I | 673.1 | I | 448.7 | I | 25.6 | I | 0.04 | I |

* DELAY IS THAT OCCURRING ONLY WITHIN THE TIME PERIOD .
 * INCLUSIVE DELAY INCLUDES DELAY SUFFERED BY VEHICLES WHICH ARE STILL QUEUEING AFTER THE END OF THE TIME PERIOD.
 * THESE WILL ONLY BE SIGNIFICANTLY DIFFERENT IF THERE IS A LARGE QUEUE REMAINING AT THE END OF THE TIME PERIOD.

END OF JOB

===== end of file =====

TRL LIMITED

(C) COPYRIGHT 2006

CAPACITIES, QUEUES, AND DELAYS AT 3 OR 4-ARM MAJOR/MINOR PRIORITY JUNCTIONS

PICADY 5.0 ANALYSIS PROGRAM
RELEASE 3.0 (JUNE 2006)

ADAPTED FROM PICADY/3 WHICH IS CROWN COPYRIGHT
BY PERMISSION OF THE CONTROLLER OF HMSO

FOR SALES AND DISTRIBUTION INFORMATION,
PROGRAM ADVICE AND MAINTENANCE CONTACT:
TRL SOFTWARE BUREAU
TEL: CROWTHORNE (01344) 770758, FAX: 770864
EMAIL: SoftwareBureau@trl.co.uk

THE USER OF THIS COMPUTER PROGRAM FOR THE SOLUTION OF AN ENGINEERING PROBLEM IS
IN NO WAY RELIEVED OF HIS RESPONSIBILITY FOR THE CORRECTNESS OF THE SOLUTION

Run with file:-

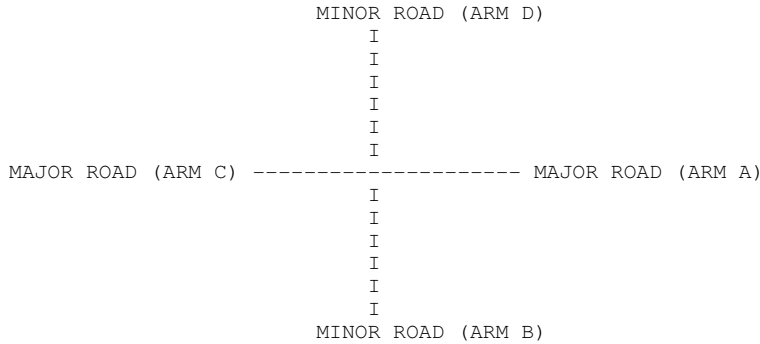
"J:\120000\120669-00\4 Internal Project Data\4-04 Calculations\4-04-06 Junction Analysis\Picady\
Site 4. B4030 Lower Heyford Rd - Port Way\2013 Base\PM\Site 4.Lower Heyford - Port Way 2013 Base PM.vpi"
(drive-on-the-left) at 09:04:28 on Wednesday, 11 July 2007

RUN INFORMATION

RUN TITLE: Site 4. Lower Heyford Rd - Port Way 2013 Base PM
LOCATION: Oxfordshire
DATE: 06/12/06
CLIENT: North Oxfordshire Consortium
ENUMERATOR: chris.morris [MCCPC062011]
JOB NUMBER: 120669
STATUS: TIA
DESCRIPTION:

.MAJOR/MINOR JUNCTION CAPACITY AND DELAY

INPUT DATA



ARM A IS Lower Heyford Road (E)
ARM B IS Port Way (S)
ARM C IS Lower Heyford Road (W)
ARM D IS Port Way (N)

STREAM LABELLING CONVENTION

STREAM A-B CONTAINS TRAFFIC GOING FROM ARM A TO ARM B
STREAM B-AC CONTAINS TRAFFIC GOING FROM ARM B TO ARM A AND TO ARM C
ETC.

 GEOMETRIC DATA

| I | DATA ITEM | I | MINOR ROAD B | I | MINOR ROAD D | I |
|---|------------------------------------|---|-----------------|---|-----------------|---|
| I | TOTAL MAJOR ROAD CARRIAGEWAY WIDTH | I | (W) 7.00 M. | I | (W) 7.00 M. | I |
| I | CENTRAL RESERVE WIDTH | I | (WCR) 0.00 M. | I | (WCR) 0.00 M. | I |
| I | | I | | I | | I |
| I | MAJOR ROAD RIGHT TURN - WIDTH | I | (WC-B) 2.20 M. | I | (WA-D) 2.20 M. | I |
| I | - VISIBILITY | I | (VC-B) 150.0 M. | I | (VA-D) 150.0 M. | I |
| I | - BLOCKS TRAFFIC | I | YES | I | YES | I |
| I | | I | | I | | I |
| I | MINOR ROAD - VISIBILITY TO LEFT | I | (VB-C) 38.0 M. | I | (VD-A) 95.0 M. | I |
| I | - VISIBILITY TO RIGHT | I | (VB-A) 72.0 M. | I | (VD-C) 92.0 M. | I |
| I | - LANE 1 WIDTH | I | (WB-C) - | I | (WD-A) - | I |
| I | - LANE 2 WIDTH | I | (WB-A) - | I | (WD-C) - | I |
| I | - WIDTH AT 0 M FROM JUNC. | I | 10.00 M. | I | 10.00 M. | I |
| I | - WIDTH AT 5 M FROM JUNC. | I | 6.00 M. | I | 8.00 M. | I |
| I | - WIDTH AT 10 M FROM JUNC. | I | 4.50 M. | I | 5.80 M. | I |
| I | - WIDTH AT 15 M FROM JUNC. | I | 4.10 M. | I | 4.00 M. | I |
| I | - WIDTH AT 20 M FROM JUNC. | I | 3.70 M. | I | 3.20 M. | I |
| I | - LENGTH OF FLARED SECTION | I | DERIVED: 1 PCU | I | 2 VEHS | I |

.SLOPES AND INTERCPET

(NB:Streams may be combined, in which case capacity will be adjusted)

B-C Stream

| I | Intercept For Stream B-C | Slope For Opposing Stream A-C | Slope For Opposing Stream A-B | I |
|---|--------------------------|-------------------------------|-------------------------------|---|
| I | 615.66 | 0.23 | 0.09 | I |

D-A Stream

| I | Intercept For Stream D-A | Slope For Opposing Stream C-A | Slope For Opposing Stream C-D | I |
|---|--------------------------|-------------------------------|-------------------------------|---|
| I | 627.24 | 0.23 | 0.09 | I |

B-A Stream

| I | Intercept For Stream B-A | Slope For Opposing Stream A-C | Slope For Opposing Stream A-D | Slope For Opposing Stream D-A | Slope For Opposing Stream D-B | I |
|---|--------------------------|-------------------------------|-------------------------------|-------------------------------|-------------------------------|---|
| I | 483.33 | 0.21 | 0.21 | 0.21 | 0.21 | I |

| I | Slope For Opposing Stream A-B | Slope For Opposing Stream C-A | Slope For Opposing Stream C-B | Slope For Opposing Stream D-C | I |
|---|-------------------------------|-------------------------------|-------------------------------|-------------------------------|---|
| I | 0.08 | 0.13 | 0.30 | 0.11 | I |

D-C Stream

| I | Intercept For Stream D-C | Slope For Opposing Stream C-A | Slope For Opposing Stream C-B | Slope For Opposing Stream B-C | Slope For Opposing Stream B-D | I |
|---|--------------------------|-------------------------------|-------------------------------|-------------------------------|-------------------------------|---|
| I | 510.47 | 0.22 | 0.22 | 0.22 | 0.22 | I |

| I | Slope For Opposing Stream C-D | Slope For Opposing Stream A-C | Slope For Opposing Stream A-D | Slope For Opposing Stream B-A | I |
|---|-------------------------------|-------------------------------|-------------------------------|-------------------------------|---|
| I | 0.09 | 0.14 | 0.32 | 0.11 | I |

C-B Stream

| I | Intercept For Stream C-B | Slope For Opposing Stream A-C | Slope For Opposing Stream A-D | I |
|---|--------------------------|-------------------------------|-------------------------------|---|
| I | 660.83 | 0.24 | 0.35 | I |

A-D Stream

| I | Intercept For Stream A-D | Slope For Opposing Stream C-A | Slope For Opposing Stream C-B | I |
|---|--------------------------|-------------------------------|-------------------------------|---|
| I | 660.83 | 0.24 | 0.35 | I |

B-D Stream From Left Hand Lane

| I | Intercept For Stream B-D | Slope For Opposing Stream A-C | Slope For Opposing Stream A-D | Slope For Opposing Stream A-B | Slope For Opposing Stream C-B | I |
|---|--------------------------|-------------------------------|-------------------------------|-------------------------------|-------------------------------|---|
| I | 483.33 | 0.21 | 0.21 | 0.08 | 0.30 | I |

| I | Slope For Opposing Stream C-A | Slope For Opposing Stream C-D | Slope For Opposing Stream C-B | I |
|---|-------------------------------|-------------------------------|-------------------------------|---|
| I | 0.13 | 0.13 | | I |

B-D Stream From Right Hand Lane

| I | Intercept For Stream B-D | Slope For Opposing Stream A-C | Slope For Opposing Stream A-D | Slope For Opposing Stream A-B | Slope For Opposing Stream C-B | I |
|---|--------------------------|-------------------------------|-------------------------------|-------------------------------|-------------------------------|---|
| I | 483.33 | 0.21 | 0.21 | 0.08 | 0.30 | I |

| I | Slope For Opposing Stream C-A | Slope For Opposing Stream C-D | Slope For Opposing Stream C-B | I |
|---|-------------------------------|-------------------------------|-------------------------------|---|
| I | 0.13 | 0.13 | | I |

D-B Stream From Left Hand Lane

| I | Intercept For Stream D-B | Slope For Opposing Stream C-A | Slope For Opposing Stream C-B | Slope For Opposing Stream D-C | Slope For Opposing Stream A-D | I |
|---|--------------------------|-------------------------------|-------------------------------|-------------------------------|-------------------------------|---|
| I | 510.47 | 0.22 | 0.22 | 0.09 | 0.32 | I |

| I | Slope For Opposing Stream A-C | Slope For Opposing Stream A-B | Slope For Opposing Stream C-B | I |
|---|-------------------------------|-------------------------------|-------------------------------|---|
| I | 0.14 | 0.14 | | I |

D-B Stream From Right Hand Lane

| I | Intercept For Stream D-B | Slope For Opposing Stream C-A | Slope For Opposing Stream C-B | Slope For Opposing Stream C-D | Slope For Opposing Stream A-D | I |
|---|--------------------------|-------------------------------|-------------------------------|-------------------------------|-------------------------------|---|
| I | 510.47 | 0.22 | 0.22 | 0.09 | 0.32 | I |

| I | Slope For Opposing Stream A-C | Slope For Opposing Stream A-B | Slope For Opposing Stream C-B | I |
|---|-------------------------------|-------------------------------|-------------------------------|---|
| I | 0.14 | 0.14 | | I |

TRAFFIC DEMAND DATA

| ARM | FLOW SCALE (%) |
|-----|----------------|
| A | 100 |
| B | 100 |
| C | 100 |
| D | 100 |

Demand set: Site 4. Lower Heyford Rd - Port Way 2013 Base PM

TIME PERIOD BEGINS 16.45 AND ENDS 18.15

LENGTH OF TIME PERIOD - 90 MINUTES.
 LENGTH OF TIME SEGMENT - 15 MINUTES.

DEMAND FLOW PROFILES ARE SYNTHESISED FROM TURNING COUNT DATA

| ARM | NUMBER OF MINUTES FROM START WHEN FLOW STARTS TO RISE | TOP OF PEAK IS REACHED | FLOW STOPS FALLING | RATE OF FLOW (VEH/MIN) BEFORE PEAK | AT TOP OF PEAK | AFTER PEAK |
|-------|---|------------------------|--------------------|------------------------------------|----------------|------------|
| ARM A | 15.00 | 45.00 | 75.00 | 2.11 | 3.17 | 2.11 |
| ARM B | 15.00 | 45.00 | 75.00 | 3.79 | 5.68 | 3.79 |
| ARM C | 15.00 | 45.00 | 75.00 | 2.06 | 3.09 | 2.06 |
| ARM D | 15.00 | 45.00 | 75.00 | 0.11 | 0.17 | 0.11 |

| TIME | TURNING PROPORTIONS | | | | |
|---------------|---------------------|--------|--------|--------|--------|
| | FROM/TO | ARM A | ARM B | ARM C | ARM D |
| 16.45 - 18.15 | ARM A | 0.000 | 0.000 | 0.994 | 0.006 |
| | | (0.0) | (0.0) | (0.0) | (0.0) |
| | ARM B | 0.383 | 0.000 | 0.515 | 0.102 |
| | | 116.0 | 0.0 | 156.0 | 31.0 |
| | | (0.0) | (0.0) | (0.0) | (0.0) |
| | ARM C | 0.758 | 0.061 | 0.000 | 0.182 |
| | | 125.0 | 10.0 | 0.0 | 30.0 |
| | | (0.0) | (0.0) | (0.0) | (0.0) |
| | ARM D | 0.111 | 0.667 | 0.222 | 0.000 |
| | | 1.0 | 6.0 | 2.0 | 0.0 |
| | | (0.0) | (0.0) | (0.0) | (0.0) |

TURNING PROPORTIONS ARE CALCULATED FROM TURNING COUNT DATA

QUEUE AND DELAY INFORMATION FOR EACH 15 MIN TIME SEGMENT

FOR COMBINED DEMAND SETS
 AND FOR TIME PERIOD 1

| TIME | DEMAND (VEH/MIN) | CAPACITY (VEH/MIN) | DEMAND/CAPACITY (RFC) | PEDESTRIAN FLOW (PEDS/MIN) | START QUEUE (VEHS) | END QUEUE (VEHS) | DELAY (VEH.MIN/TIME SEGMENT) | GEOMETRIC DELAY (VEH.MIN/TIME SEGMENT) | AVERAGE DELAY PER ARRIVING VEHICLE (MIN) |
|--|------------------|--------------------|-----------------------|----------------------------|-----------------------------------|-------------------------|------------------------------|--|--|
| 16.45-17.00 | | | | | | | | | |
| B-CD | 2.19 | 10.13 | 0.216 | | 0.00 | 0.27 | 3.9 | | 0.13 |
| B-AD | 1.62 | 8.24 | 0.196 | | 0.00 | 0.24 | 3.5 | | 0.15 |
| A-BCD | 0.01 | 10.49 | 0.001 | | 0.00 | 0.00 | 0.0 | | 0.10 |
| D-AB | 0.05 | 10.65 | 0.005 | | 0.00 | 0.00 | 0.1 | | 0.09 |
| D-BC | 0.06 | 8.19 | 0.008 | | 0.00 | 0.01 | 0.1 | | 0.12 |
| C-ABD | 0.13 | 10.49 | 0.012 | | 0.00 | 0.01 | 0.2 | | 0.10 |
| EFFECT ON CAPACITY (PCU/MIN) OF MARGINAL CHANGES IN: | | | | | | | | | |
| MARGINAL CHANGE: | LANE WIDTH (.1M) | WIDTH (.1M) | MAJOR RD. WIDTH (.1M) | CENT RES WIDTH (.1M) | VIS TO LEFT (AHEAD FOR MAJOR) (M) | VISIBILITY TO RIGHT (M) | | | |
| B-CD | 0.098 | 0.003 | 0.004 | 0.001 | 0.009 | | | | |
| B-AD | 0.080 | 0.004 | 0.020 | 0.005 | 0.008 | | | | |
| C-ABD | 0.114 | 0.002 | | 0.009 | | | | | |
| D-AB | 0.090 | 0.004 | 0.021 | 0.005 | 0.010 | | | | |
| D-BC | 0.082 | 0.005 | 0.021 | 0.005 | 0.008 | | | | |
| A-BCD | 0.114 | 0.002 | | 0.009 | | | | | |

| I | TIME | DEMAND (VEH/MIN) | CAPACITY (VEH/MIN) | DEMAND/ CAPACITY (RFC) | PEDESTRIAN FLOW (PEDS/MIN) | START QUEUE (VEHS) | END QUEUE (VEHS) | DELAY (VEH.MIN/ TIME SEGMENT) | GEOMETRIC DELAY (VEH.MIN/ TIME SEGMENT) | AVERAGE DELAY PER ARRIVING VEHICLE (MIN) | I | |
|---|-------------|---------------------------------|-----------------------|------------------------------|----------------------------------|----------------------------------|------------------------|-------------------------------------|---|--|---|---|
| I | 17.00-17.15 | | | | | | | | | | I | |
| I | B-CD | 2.62 | 9.82 | 0.267 | | 0.27 | 0.36 | 5.2 | | 0.14 | I | |
| I | B-AD | 1.92 | 8.05 | 0.238 | | 0.24 | 0.31 | 4.5 | | 0.16 | I | |
| I | A-BCD | 0.01 | 10.39 | 0.001 | | 0.00 | 0.00 | 0.0 | | 0.10 | I | |
| I | D-AB | 0.06 | 10.48 | 0.006 | | 0.00 | 0.01 | 0.1 | | 0.10 | I | |
| I | D-BC | 0.07 | 7.97 | 0.009 | | 0.01 | 0.01 | 0.1 | | 0.13 | I | |
| I | C-ABD | 0.15 | 10.39 | 0.014 | | 0.01 | 0.01 | 0.2 | | 0.10 | I | |
| I | | | | | | | | | | | I | |
| I | | EFFECT ON CAPACITY (PCU/MIN) OF | | | | | MARGINAL CHANGES IN: | | | | | I |
| I | | MARGINAL | LANE WIDTH | MAJOR RD. WIDTH | CENT RES WIDTH | VIS TO LEFT (AHEAD FOR MAJOR) | | VISIBILITY TO RIGHT | | | I | |
| I | | CHANGE: | (.1M) | (.1M) | (.1M) | (M) | | (M) | | | I | |
| I | | | | | | | | | | | I | |
| I | B-CD | | 0.095 | 0.003 | 0.004 | 0.001 | | 0.009 | | | I | |
| I | B-AD | | 0.078 | 0.004 | 0.020 | 0.005 | | 0.008 | | | I | |
| I | C-ABD | | 0.113 | 0.003 | | 0.009 | | | | | I | |
| I | D-AB | | 0.088 | 0.005 | 0.021 | 0.005 | | 0.010 | | | I | |
| I | D-BC | | 0.079 | 0.006 | 0.021 | 0.005 | | 0.007 | | | I | |
| I | A-BCD | | 0.113 | 0.003 | | 0.009 | | | | | I | |

| I | TIME | DEMAND (VEH/MIN) | CAPACITY (VEH/MIN) | DEMAND/ CAPACITY (RFC) | PEDESTRIAN FLOW (PEDS/MIN) | START QUEUE (VEHS) | END QUEUE (VEHS) | DELAY (VEH.MIN/ TIME SEGMENT) | GEOMETRIC DELAY (VEH.MIN/ TIME SEGMENT) | AVERAGE DELAY PER ARRIVING VEHICLE (MIN) | I | |
|---|-------------|---------------------------------|-----------------------|------------------------------|----------------------------------|----------------------------------|------------------------|-------------------------------------|---|--|---|---|
| I | 17.15-17.30 | | | | | | | | | | I | |
| I | B-CD | 3.22 | 9.35 | 0.345 | | 0.36 | 0.52 | 7.5 | | 0.16 | I | |
| I | B-AD | 2.34 | 7.76 | 0.301 | | 0.31 | 0.42 | 6.1 | | 0.18 | I | |
| I | A-BCD | 0.02 | 10.25 | 0.002 | | 0.00 | 0.00 | 0.0 | | 0.10 | I | |
| I | D-AB | 0.07 | 10.24 | 0.007 | | 0.01 | 0.01 | 0.1 | | 0.10 | I | |
| I | D-BC | 0.09 | 7.66 | 0.012 | | 0.01 | 0.01 | 0.2 | | 0.13 | I | |
| I | C-ABD | 0.18 | 10.25 | 0.018 | | 0.01 | 0.02 | 0.3 | | 0.10 | I | |
| I | | | | | | | | | | | I | |
| I | | EFFECT ON CAPACITY (PCU/MIN) OF | | | | | MARGINAL CHANGES IN: | | | | | I |
| I | | MARGINAL | LANE WIDTH | MAJOR RD. WIDTH | CENT RES WIDTH | VIS TO LEFT (AHEAD FOR MAJOR) | | VISIBILITY TO RIGHT | | | I | |
| I | | CHANGE: | (.1M) | (.1M) | (.1M) | (M) | | (M) | | | I | |
| I | | | | | | | | | | | I | |
| I | B-CD | | 0.092 | 0.004 | 0.004 | 0.001 | | 0.008 | | | I | |
| I | B-AD | | 0.076 | 0.005 | 0.020 | 0.005 | | 0.007 | | | I | |
| I | C-ABD | | 0.112 | 0.003 | | 0.009 | | | | | I | |
| I | D-AB | | 0.086 | 0.006 | 0.021 | 0.005 | | 0.009 | | | I | |
| I | D-BC | | 0.076 | 0.007 | 0.021 | 0.005 | | 0.007 | | | I | |
| I | A-BCD | | 0.112 | 0.003 | | 0.009 | | | | | I | |

| I | TIME | DEMAND (VEH/MIN) | CAPACITY (VEH/MIN) | DEMAND/ CAPACITY (RFC) | PEDESTRIAN FLOW (PEDS/MIN) | START QUEUE (VEHS) | END QUEUE (VEHS) | DELAY (VEH.MIN/ TIME SEGMENT) | GEOMETRIC DELAY (VEH.MIN/ TIME SEGMENT) | AVERAGE DELAY PER ARRIVING VEHICLE (MIN) | I | |
|---|-------------|---------------------------------|-----------------------|------------------------------|----------------------------------|----------------------------------|------------------------|-------------------------------------|---|--|---|---|
| I | 17.30-17.45 | | | | | | | | | | I | |
| I | B-CD | 3.22 | 9.34 | 0.345 | | 0.52 | 0.52 | 7.8 | | 0.16 | I | |
| I | B-AD | 2.34 | 7.76 | 0.301 | | 0.42 | 0.43 | 6.4 | | 0.18 | I | |
| I | A-BCD | 0.02 | 10.25 | 0.002 | | 0.00 | 0.00 | 0.0 | | 0.10 | I | |
| I | D-AB | 0.07 | 10.24 | 0.007 | | 0.01 | 0.01 | 0.1 | | 0.10 | I | |
| I | D-BC | 0.09 | 7.66 | 0.012 | | 0.01 | 0.01 | 0.2 | | 0.13 | I | |
| I | C-ABD | 0.18 | 10.25 | 0.018 | | 0.02 | 0.02 | 0.3 | | 0.10 | I | |
| I | | | | | | | | | | | I | |
| I | | EFFECT ON CAPACITY (PCU/MIN) OF | | | | | MARGINAL CHANGES IN: | | | | | I |
| I | | MARGINAL | LANE WIDTH | MAJOR RD. WIDTH | CENT RES WIDTH | VIS TO LEFT (AHEAD FOR MAJOR) | | VISIBILITY TO RIGHT | | | I | |
| I | | CHANGE: | (.1M) | (.1M) | (.1M) | (M) | | (M) | | | I | |
| I | | | | | | | | | | | I | |
| I | B-CD | | 0.092 | 0.004 | 0.004 | 0.001 | | 0.008 | | | I | |
| I | B-AD | | 0.076 | 0.005 | 0.020 | 0.005 | | 0.007 | | | I | |
| I | C-ABD | | 0.112 | 0.003 | | 0.009 | | | | | I | |
| I | D-AB | | 0.086 | 0.006 | 0.021 | 0.005 | | 0.009 | | | I | |
| I | D-BC | | 0.076 | 0.007 | 0.021 | 0.005 | | 0.007 | | | I | |
| I | A-BCD | | 0.112 | 0.003 | | 0.009 | | | | | I | |

| I | TIME | DEMAND (VEH/MIN) | CAPACITY (VEH/MIN) | DEMAND/ CAPACITY (RFC) | PEDESTRIAN FLOW (PEDS/MIN) | START QUEUE (VEHS) | END QUEUE (VEHS) | DELAY (VEH.MIN/ TIME SEGMENT) | GEOMETRIC DELAY (VEH.MIN/ TIME SEGMENT) | AVERAGE DELAY PER ARRIVING VEHICLE (MIN) | I | |
|---|-------------|---|-----------------------|------------------------------|----------------------------------|--------------------------|------------------------|-------------------------------------|---|--|---|---|
| I | 17.45-18.00 | | | | | | | | | | I | |
| I | B-CD | 2.62 | 9.82 | 0.267 | | 0.52 | 0.37 | 5.7 | | 0.14 | I | |
| I | B-AD | 1.92 | 8.05 | 0.238 | | 0.43 | 0.32 | 4.9 | | 0.16 | I | |
| I | A-BCD | 0.01 | 10.39 | 0.001 | | 0.00 | 0.00 | 0.0 | | 0.10 | I | |
| I | D-AB | 0.06 | 10.48 | 0.006 | | 0.01 | 0.01 | 0.1 | | 0.10 | I | |
| I | D-BC | 0.07 | 7.96 | 0.009 | | 0.01 | 0.01 | 0.1 | | 0.13 | I | |
| I | C-ABD | 0.15 | 10.39 | 0.014 | | 0.02 | 0.01 | 0.2 | | 0.10 | I | |
| I | | | | | | | | | | | I | |
| I | | EFFECT ON CAPACITY (PCU/MIN) OF MAJOR RD. CENT RES VIS TO LEFT VISIBILITY | | | | | | | | | | I |
| I | MARGINAL | LANE WIDTH | WIDTH | WIDTH | (AHEAD FOR MAJOR) | TO RIGHT | | | | | I | |
| I | CHANGE: | (.1M) | (.1M) | (.1M) | (M) | (M) | | | | | I | |
| I | B-CD | 0.095 | 0.003 | 0.004 | 0.001 | 0.009 | | | | | I | |
| I | B-AD | 0.078 | 0.004 | 0.020 | 0.005 | 0.008 | | | | | I | |
| I | C-ABD | 0.113 | 0.003 | | 0.009 | | | | | | I | |
| I | D-AB | 0.088 | 0.005 | 0.021 | 0.005 | 0.010 | | | | | I | |
| I | D-BC | 0.079 | 0.006 | 0.021 | 0.005 | 0.007 | | | | | I | |
| I | A-BCD | 0.113 | 0.003 | | 0.009 | | | | | | I | |

| I | TIME | DEMAND (VEH/MIN) | CAPACITY (VEH/MIN) | DEMAND/ CAPACITY (RFC) | PEDESTRIAN FLOW (PEDS/MIN) | START QUEUE (VEHS) | END QUEUE (VEHS) | DELAY (VEH.MIN/ TIME SEGMENT) | GEOMETRIC DELAY (VEH.MIN/ TIME SEGMENT) | AVERAGE DELAY PER ARRIVING VEHICLE (MIN) | I | |
|---|-------------|---|-----------------------|------------------------------|----------------------------------|--------------------------|------------------------|-------------------------------------|---|--|---|---|
| I | 18.00-18.15 | | | | | | | | | | I | |
| I | B-CD | 2.19 | 10.12 | 0.216 | | 0.37 | 0.28 | 4.3 | | 0.13 | I | |
| I | B-AD | 1.62 | 8.24 | 0.196 | | 0.32 | 0.25 | 3.8 | | 0.15 | I | |
| I | A-BCD | 0.01 | 10.49 | 0.001 | | 0.00 | 0.00 | 0.0 | | 0.10 | I | |
| I | D-AB | 0.05 | 10.65 | 0.005 | | 0.01 | 0.00 | 0.1 | | 0.09 | I | |
| I | D-BC | 0.06 | 8.18 | 0.008 | | 0.01 | 0.01 | 0.1 | | 0.12 | I | |
| I | C-ABD | 0.13 | 10.49 | 0.012 | | 0.01 | 0.01 | 0.2 | | 0.10 | I | |
| I | | | | | | | | | | | I | |
| I | | EFFECT ON CAPACITY (PCU/MIN) OF MAJOR RD. CENT RES VIS TO LEFT VISIBILITY | | | | | | | | | | I |
| I | MARGINAL | LANE WIDTH | WIDTH | WIDTH | (AHEAD FOR MAJOR) | TO RIGHT | | | | | I | |
| I | CHANGE: | (.1M) | (.1M) | (.1M) | (M) | (M) | | | | | I | |
| I | B-CD | 0.098 | 0.003 | 0.004 | 0.001 | 0.009 | | | | | I | |
| I | B-AD | 0.080 | 0.004 | 0.020 | 0.005 | 0.008 | | | | | I | |
| I | C-ABD | 0.114 | 0.002 | | 0.009 | | | | | | I | |
| I | D-AB | 0.090 | 0.004 | 0.021 | 0.005 | 0.010 | | | | | I | |
| I | D-BC | 0.082 | 0.005 | 0.021 | 0.005 | 0.008 | | | | | I | |
| I | A-BCD | 0.114 | 0.002 | | 0.009 | | | | | | I | |

QUEUE FOR STREAM B-CD

| TIME SEGMENT ENDING | NO. OF VEHICLES IN QUEUE | |
|------------------------|--------------------------------|---|
| 17.00 | 0.3 | |
| 17.15 | 0.4 | |
| 17.30 | 0.5 | * |
| 17.45 | 0.5 | * |
| 18.00 | 0.4 | |
| 18.15 | 0.3 | |

QUEUE FOR STREAM B-AD

| TIME SEGMENT ENDING | NO. OF VEHICLES IN QUEUE |
|------------------------|--------------------------------|
| 17.00 | 0.2 |
| 17.15 | 0.3 |
| 17.30 | 0.4 |
| 17.45 | 0.4 |
| 18.00 | 0.3 |
| 18.15 | 0.2 |

QUEUE FOR STREAM A-BCD

| TIME SEGMENT ENDING | NO. OF VEHICLES IN QUEUE |
|------------------------|--------------------------------|
| 17.00 | 0.0 |
| 17.15 | 0.0 |
| 17.30 | 0.0 |
| 17.45 | 0.0 |
| 18.00 | 0.0 |
| 18.15 | 0.0 |

QUEUE FOR STREAM D-AB

| TIME SEGMENT ENDING | NO. OF VEHICLES IN QUEUE |
|------------------------|--------------------------------|
| 17.00 | 0.0 |
| 17.15 | 0.0 |
| 17.30 | 0.0 |
| 17.45 | 0.0 |
| 18.00 | 0.0 |
| 18.15 | 0.0 |

QUEUE FOR STREAM D-BC

| TIME SEGMENT ENDING | NO. OF VEHICLES IN QUEUE |
|------------------------|--------------------------------|
| 17.00 | 0.0 |
| 17.15 | 0.0 |
| 17.30 | 0.0 |
| 17.45 | 0.0 |
| 18.00 | 0.0 |
| 18.15 | 0.0 |

QUEUE FOR STREAM C-ABD

| TIME SEGMENT ENDING | NO. OF VEHICLES IN QUEUE |
|------------------------|--------------------------------|
| 17.00 | 0.0 |
| 17.15 | 0.0 |
| 17.30 | 0.0 |
| 17.45 | 0.0 |
| 18.00 | 0.0 |
| 18.15 | 0.0 |

QUEUEING DELAY INFORMATION OVER WHOLE PERIOD

| I | STREAM | I | TOTAL DEMAND | I | * QUEUEING * | I | * INCLUSIVE QUEUEING * | I | | |
|---|--------|-------|--------------|---|--------------|-----------|------------------------|-----------|------|---|
| I | I | I | I | I | * DELAY * | I | * DELAY * | I | | |
| I | I | I | I | I | I | I | I | I | | |
| I | I | (VEH) | (VEH/H) | I | (MIN) | (MIN/VEH) | (MIN) | (MIN/VEH) | | |
| I | B-CD | I | 240.9 | I | 160.6 | I | 34.5 | I | 0.14 | I |
| I | B-AD | I | 176.1 | I | 117.4 | I | 29.2 | I | 0.17 | I |
| I | A-BCD | I | 1.4 | I | 0.9 | I | 0.1 | I | 0.10 | I |
| I | D-AB | I | 5.5 | I | 3.7 | I | 0.5 | I | 0.10 | I |
| I | D-BC | I | 6.9 | I | 4.6 | I | 0.9 | I | 0.13 | I |
| I | C-ABD | I | 13.8 | I | 9.2 | I | 1.4 | I | 0.10 | I |
| I | ALL | I | 889.2 | I | 592.8 | I | 66.6 | I | 0.07 | I |

* DELAY IS THAT OCCURRING ONLY WITHIN THE TIME PERIOD .
 * INCLUSIVE DELAY INCLUDES DELAY SUFFERED BY VEHICLES WHICH ARE STILL QUEUEING AFTER THE END OF THE TIME PERIOD.
 * THESE WILL ONLY BE SIGNIFICANTLY DIFFERENT IF THERE IS A LARGE QUEUE REMAINING AT THE END OF THE TIME PERIOD.

END OF JOB

===== end of file =====

TRL LIMITED

(C) COPYRIGHT 2006

CAPACITIES, QUEUES, AND DELAYS AT 3 OR 4-ARM MAJOR/MINOR PRIORITY JUNCTIONS

PICADY 5.0 ANALYSIS PROGRAM
RELEASE 3.0 (JUNE 2006)

ADAPTED FROM PICADY/3 WHICH IS CROWN COPYRIGHT
BY PERMISSION OF THE CONTROLLER OF HMSO

FOR SALES AND DISTRIBUTION INFORMATION,
PROGRAM ADVICE AND MAINTENANCE CONTACT:
TRL SOFTWARE BUREAU
TEL: CROWTHORNE (01344) 770758, FAX: 770864
EMAIL: SoftwareBureau@trl.co.uk

THE USER OF THIS COMPUTER PROGRAM FOR THE SOLUTION OF AN ENGINEERING PROBLEM IS
IN NO WAY RELIEVED OF HIS RESPONSIBILITY FOR THE CORRECTNESS OF THE SOLUTION

Run with file:-

"J:\120000\120669-00\4 Internal Project Data\4-04 Calculations\4-04-06 Junction Analysis\Picady\
Site 4. B4030 Lower Heyford Rd - Port Way\2013 Base + Gen\AM\
Site 4.Lower Heyford - Port Way 2013 Base + Full Development AM.vpi"
(drive-on-the-left) at 15:20:22 on Monday, 30 July 2007

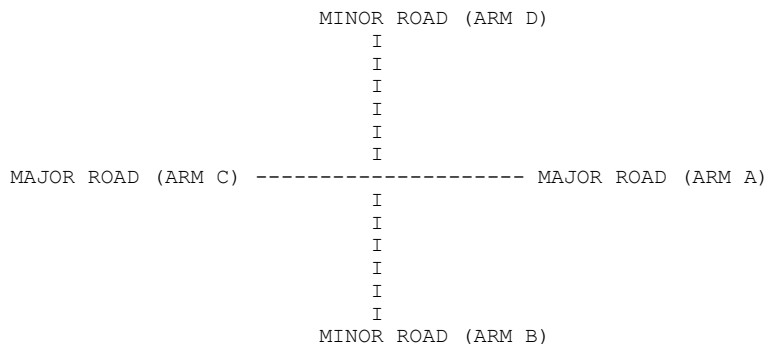
RUN INFORMATION

RUN TITLE: Site 4. Lower Heyford Rd - Port Way 2013 Base & Full Development AM
LOCATION: Oxfordshire
DATE: 30/07/07
CLIENT: North Oxfordshire Consortium
ENUMERATOR: Ian Clarke
JOB NUMBER: 120669
STATUS: TIA

DESCRIPTION:

.MAJOR/MINOR JUNCTION CAPACITY AND DELAY

INPUT DATA



ARM A IS Lower Heyford Road (E)
ARM B IS Port Way (S)
ARM C IS Lower Heyford Road (W)
ARM D IS Port Way (N)

STREAM LABELLING CONVENTION

STREAM A-B CONTAINS TRAFFIC GOING FROM ARM A TO ARM B
STREAM B-AC CONTAINS TRAFFIC GOING FROM ARM B TO ARM A AND TO ARM C
ETC.

GEOMETRIC DATA

| DATA ITEM | MINOR ROAD B | MINOR ROAD D |
|------------------------------------|-----------------|-----------------|
| TOTAL MAJOR ROAD CARRIAGEWAY WIDTH | (W) 7.00 M. | (W) 7.00 M. |
| CENTRAL RESERVE WIDTH | (WCR) 0.00 M. | (WCR) 0.00 M. |
| MAJOR ROAD RIGHT TURN - WIDTH | (WC-B) 2.20 M. | (WA-D) 2.20 M. |
| - VISIBILITY | (VC-B) 150.0 M. | (VA-D) 150.0 M. |
| - BLOCKS TRAFFIC | YES | YES |
| MINOR ROAD - VISIBILITY TO LEFT | (VB-C) 38.0 M. | (VD-A) 95.0 M. |
| - VISIBILITY TO RIGHT | (VB-A) 72.0 M. | (VD-C) 92.0 M. |
| - LANE 1 WIDTH | (WB-C) - | (WD-A) - |
| - LANE 2 WIDTH | (WB-A) - | (WD-C) - |
| - WIDTH AT 0 M FROM JUNC. | 10.00 M. | 10.00 M. |
| - WIDTH AT 5 M FROM JUNC. | 6.00 M. | 8.00 M. |
| - WIDTH AT 10 M FROM JUNC. | 4.50 M. | 5.80 M. |
| - WIDTH AT 15 M FROM JUNC. | 4.10 M. | 4.00 M. |
| - WIDTH AT 20 M FROM JUNC. | 3.70 M. | 3.20 M. |
| - LENGTH OF FLARED SECTION | DERIVED: 1 PCU | 2 VEHS |

.SLOPES AND INTERCPET

(NB:Streams may be combined, in which case capacity will be adjusted)

B-C Stream

| Intercept For Stream B-C | Slope For Opposing Stream A-C | Slope For Opposing Stream A-B |
|--------------------------|-------------------------------|-------------------------------|
| 615.66 | 0.23 | 0.09 |

D-A Stream

| Intercept For Stream D-A | Slope For Opposing Stream C-A | Slope For Opposing Stream C-D |
|--------------------------|-------------------------------|-------------------------------|
| 627.24 | 0.23 | 0.09 |

B-A Stream

| Intercept For Stream B-A | Slope For Opposing Stream A-C | Slope For Opposing Stream A-D | Slope For Opposing Stream D-A | Slope For Opposing Stream D-B |
|--------------------------|-------------------------------|-------------------------------|-------------------------------|-------------------------------|
| 483.33 | 0.21 | 0.21 | 0.21 | 0.21 |

| Slope For Opposing Stream A-B | Slope For Opposing Stream C-A | Slope For Opposing Stream C-B | Slope For Opposing Stream D-C |
|-------------------------------|-------------------------------|-------------------------------|-------------------------------|
| 0.08 | 0.13 | 0.30 | 0.11 |

D-C Stream

| Intercept For Stream D-C | Slope For Opposing Stream C-A | Slope For Opposing Stream C-B | Slope For Opposing Stream B-C | Slope For Opposing Stream B-D |
|--------------------------|-------------------------------|-------------------------------|-------------------------------|-------------------------------|
| 510.47 | 0.22 | 0.22 | 0.22 | 0.22 |

| Slope For Opposing Stream C-D | Slope For Opposing Stream A-C | Slope For Opposing Stream A-D | Slope For Opposing Stream B-A |
|-------------------------------|-------------------------------|-------------------------------|-------------------------------|
| 0.09 | 0.14 | 0.32 | 0.11 |

C-B Stream

| Intercept For Stream C-B | Slope For Opposing Stream A-C | Slope For Opposing Stream A-D |
|--------------------------|-------------------------------|-------------------------------|
| 660.83 | 0.24 | 0.35 |

A-D Stream

| I | Intercept For Stream A-D | Slope For Opposing Stream C-A | Slope For Opposing Stream C-B | I |
|---|--------------------------|-------------------------------|-------------------------------|---|
| I | 660.83 | 0.24 | 0.35 | I |

B-D Stream From Left Hand Lane

| I | Intercept For Stream B-D | Slope For Opposing Stream A-C | Slope For Opposing Stream A-D | Slope For Opposing Stream A-B | Slope For Opposing Stream C-B | I |
|---|--------------------------|-------------------------------|-------------------------------|-------------------------------|-------------------------------|---|
| I | 483.33 | 0.21 | 0.21 | 0.08 | 0.30 | I |

| I | Slope For Opposing Stream C-A | Slope For Opposing Stream C-D | Slope For Opposing Stream C-B | I |
|---|-------------------------------|-------------------------------|-------------------------------|---|
| I | 0.13 | 0.13 | | I |

B-D Stream From Right Hand Lane

| I | Intercept For Stream B-D | Slope For Opposing Stream A-C | Slope For Opposing Stream A-D | Slope For Opposing Stream A-B | Slope For Opposing Stream C-B | I |
|---|--------------------------|-------------------------------|-------------------------------|-------------------------------|-------------------------------|---|
| I | 483.33 | 0.21 | 0.21 | 0.08 | 0.30 | I |

| I | Slope For Opposing Stream C-A | Slope For Opposing Stream C-D | Slope For Opposing Stream C-B | I |
|---|-------------------------------|-------------------------------|-------------------------------|---|
| I | 0.13 | 0.13 | | I |

D-B Stream From Left Hand Lane

| I | Intercept For Stream D-B | Slope For Opposing Stream C-A | Slope For Opposing Stream C-B | Slope For Opposing Stream D-C | Slope For Opposing Stream A-D | I |
|---|--------------------------|-------------------------------|-------------------------------|-------------------------------|-------------------------------|---|
| I | 510.47 | 0.22 | 0.22 | 0.09 | 0.32 | I |

| I | Slope For Opposing Stream A-C | Slope For Opposing Stream A-B | Slope For Opposing Stream C-B | I |
|---|-------------------------------|-------------------------------|-------------------------------|---|
| I | 0.14 | 0.14 | | I |

D-B Stream From Right Hand Lane

| I | Intercept For Stream D-B | Slope For Opposing Stream C-A | Slope For Opposing Stream C-B | Slope For Opposing Stream C-D | Slope For Opposing Stream A-D | I |
|---|--------------------------|-------------------------------|-------------------------------|-------------------------------|-------------------------------|---|
| I | 510.47 | 0.22 | 0.22 | 0.09 | 0.32 | I |

| I | Slope For Opposing Stream A-C | Slope For Opposing Stream A-B | Slope For Opposing Stream C-B | I |
|---|-------------------------------|-------------------------------|-------------------------------|---|
| I | 0.14 | 0.14 | | I |

TRAFFIC DEMAND DATA

| ARM | FLOW SCALE (%) |
|-----|----------------|
| A | 100 |
| B | 100 |
| C | 100 |
| D | 100 |

Demand set: Site 4. Lower Heyford Rd - Port Way 2013 Base AM

TIME PERIOD BEGINS 07.45 AND ENDS 09.15

LENGTH OF TIME PERIOD - 90 MINUTES.
 LENGTH OF TIME SEGMENT - 15 MINUTES.

DEMAND FLOW PROFILES ARE SYNTHESISED FROM TURNING COUNT DATA

| ARM | NUMBER OF MINUTES FROM START WHEN FLOW STARTS TO RISE | TOP OF PEAK IS REACHED | FLOW STOPS FALLING | RATE OF FLOW (VEH/MIN) BEFORE PEAK | AT TOP OF PEAK | AFTER PEAK |
|-------|---|------------------------|--------------------|------------------------------------|----------------|------------|
| ARM A | 15.00 | 45.00 | 75.00 | 1.90 | 2.85 | 1.90 |
| ARM B | 15.00 | 45.00 | 75.00 | 1.69 | 2.53 | 1.69 |
| ARM C | 15.00 | 45.00 | 75.00 | 2.89 | 4.33 | 2.89 |
| ARM D | 15.00 | 45.00 | 75.00 | 1.29 | 1.93 | 1.29 |

| TIME | TURNING PROPORTIONS | | | | |
|---------------|---------------------|--------|--------|--------|--------|
| | FROM/TO | ARM A | ARM B | ARM C | ARM D |
| 07.45 - 09.15 | ARM A | 0.000 | 0.105 | 0.895 | 0.000 |
| | | (0.0) | (0.0) | (0.0) | (0.0) |
| | ARM B | 0.326 | 0.000 | 0.252 | 0.422 |
| | | 44.0 | 0.0 | 34.0 | 57.0 |
| | | (0.0) | (0.0) | (0.0) | (0.0) |
| | ARM C | 0.762 | 0.238 | 0.000 | 0.000 |
| | | 176.0 | 55.0 | 0.0 | 0.0 |
| | | (0.0) | (0.0) | (0.0) | (0.0) |
| | ARM D | 0.019 | 0.961 | 0.019 | 0.000 |
| | | 2.0 | 99.0 | 2.0 | 0.0 |
| | | (0.0) | (0.0) | (0.0) | (0.0) |

TURNING PROPORTIONS ARE CALCULATED FROM TURNING COUNT DATA

QUEUE AND DELAY INFORMATION FOR EACH 15 MIN TIME SEGMENT

FOR COMBINED DEMAND SETS
 AND FOR TIME PERIOD 1

| TIME | DEMAND (VEH/MIN) | CAPACITY (VEH/MIN) | DEMAND/CAPACITY (RFC) | PEDESTRIAN FLOW (PEDS/MIN) | START QUEUE (VEHS) | END QUEUE (VEHS) | DELAY (VEH.MIN/TIME SEGMENT) | GEOMETRIC DELAY (VEH.MIN/TIME SEGMENT) | AVERAGE DELAY PER ARRIVING VEHICLE (MIN) |
|-------------|------------------|--------------------|-----------------------|----------------------------|--------------------|------------------|------------------------------|--|--|
| 07.45-08.00 | | | | | | | | | |
| B-CD | 0.81 | 9.72 | 0.083 | | 0.00 | 0.09 | 1.3 | | 0.11 |
| B-AD | 0.88 | 7.45 | 0.118 | | 0.00 | 0.13 | 1.9 | | 0.15 |
| A-BCD | 0.00 | 9.30 | 0.000 | | 0.00 | 0.00 | 0.0 | | 0.00 |
| D-AB | 0.65 | 9.79 | 0.066 | | 0.00 | 0.07 | 1.0 | | 0.11 |
| D-BC | 0.64 | 8.18 | 0.079 | | 0.00 | 0.08 | 1.2 | | 0.13 |
| C-ABD | 0.69 | 10.55 | 0.065 | | 0.00 | 0.07 | 1.0 | | 0.10 |

EFFECT ON CAPACITY (PCU/MIN) OF MARGINAL CHANGES IN:

| MARGINAL CHANGE: | LANE WIDTH (.1M) | MAJOR RD. WIDTH (.1M) | CENT RES WIDTH (.1M) | VIS TO LEFT (AHEAD FOR MAJOR) (M) | VISIBILITY TO RIGHT (M) |
|------------------|------------------|-----------------------|----------------------|-----------------------------------|-------------------------|
| B-CD | 0.088 | 0.004 | 0.014 | 0.003 | 0.009 |
| B-AD | 0.076 | 0.005 | 0.019 | 0.005 | 0.007 |
| C-ABD | 0.115 | 0.002 | | 0.009 | |
| D-AB | 0.082 | 0.005 | 0.024 | 0.006 | 0.009 |
| D-BC | 0.082 | 0.005 | 0.021 | 0.005 | 0.008 |
| A-BCD | 0.111 | 0.004 | | 0.009 | |

| I | TIME | DEMAND (VEH/MIN) | CAPACITY (VEH/MIN) | DEMAND/ CAPACITY (RFC) | PEDESTRIAN FLOW (PEDS/MIN) | START QUEUE (VEHS) | END QUEUE (VEHS) | DELAY (VEH.MIN/ TIME SEGMENT) | GEOMETRIC DELAY (VEH.MIN/ TIME SEGMENT) | AVERAGE DELAY PER ARRIVING VEHICLE (MIN) | I |
|---|--|---------------------|-----------------------|------------------------------|----------------------------------|--------------------------|------------------------|-------------------------------------|---|--|---|
| I | 08.00-08.15 | | | | | | | | | | I |
| I | B-CD | 0.98 | 9.47 | 0.103 | | 0.09 | 0.11 | 1.7 | | 0.12 | I |
| I | B-AD | 1.05 | 7.22 | 0.145 | | 0.13 | 0.17 | 2.4 | | 0.16 | I |
| I | A-BCD | 0.00 | 9.16 | 0.000 | | 0.00 | 0.00 | 0.0 | | 0.00 | I |
| I | D-AB | 0.77 | 9.52 | 0.081 | | 0.07 | 0.09 | 1.3 | | 0.11 | I |
| I | D-BC | 0.77 | 7.98 | 0.096 | | 0.08 | 0.11 | 1.5 | | 0.14 | I |
| I | C-ABD | 0.82 | 10.46 | 0.079 | | 0.07 | 0.09 | 1.3 | | 0.10 | I |
| I | EFFECT ON CAPACITY (PCU/MIN) OF MARGINAL CHANGES IN: | | | | | | | | | | |
| I | MARGINAL | LANE WIDTH | MAJOR RD. | CENT RES | VIS TO LEFT | VISIBILITY | | | | | I |
| I | CHANGE: | (.1M) | WIDTH (.1M) | WIDTH (.1M) | (M) | TO RIGHT (M) | | | | | I |
| I | B-CD | 0.086 | 0.005 | 0.014 | 0.003 | 0.009 | | | | | I |
| I | B-AD | 0.074 | 0.006 | 0.019 | 0.005 | 0.007 | | | | | I |
| I | C-ABD | 0.114 | 0.003 | | 0.009 | | | | | | I |
| I | D-AB | 0.079 | 0.006 | 0.024 | 0.006 | 0.009 | | | | | I |
| I | D-BC | 0.080 | 0.006 | 0.021 | 0.005 | 0.007 | | | | | I |
| I | A-BCD | 0.110 | 0.004 | | 0.009 | | | | | | I |

| I | TIME | DEMAND (VEH/MIN) | CAPACITY (VEH/MIN) | DEMAND/ CAPACITY (RFC) | PEDESTRIAN FLOW (PEDS/MIN) | START QUEUE (VEHS) | END QUEUE (VEHS) | DELAY (VEH.MIN/ TIME SEGMENT) | GEOMETRIC DELAY (VEH.MIN/ TIME SEGMENT) | AVERAGE DELAY PER ARRIVING VEHICLE (MIN) | I |
|---|--|---------------------|-----------------------|------------------------------|----------------------------------|--------------------------|------------------------|-------------------------------------|---|--|---|
| I | 08.15-08.30 | | | | | | | | | | I |
| I | B-CD | 1.21 | 9.11 | 0.133 | | 0.11 | 0.15 | 2.2 | | 0.13 | I |
| I | B-AD | 1.27 | 6.90 | 0.184 | | 0.17 | 0.22 | 3.2 | | 0.18 | I |
| I | A-BCD | 0.00 | 8.97 | 0.000 | | 0.00 | 0.00 | 0.0 | | 0.00 | I |
| I | D-AB | 0.95 | 9.15 | 0.104 | | 0.09 | 0.11 | 1.7 | | 0.12 | I |
| I | D-BC | 0.94 | 7.71 | 0.122 | | 0.11 | 0.14 | 2.0 | | 0.15 | I |
| I | C-ABD | 1.01 | 10.33 | 0.098 | | 0.09 | 0.11 | 1.7 | | 0.11 | I |
| I | EFFECT ON CAPACITY (PCU/MIN) OF MARGINAL CHANGES IN: | | | | | | | | | | |
| I | MARGINAL | LANE WIDTH | MAJOR RD. | CENT RES | VIS TO LEFT | VISIBILITY | | | | | I |
| I | CHANGE: | (.1M) | WIDTH (.1M) | WIDTH (.1M) | (M) | TO RIGHT (M) | | | | | I |
| I | B-CD | 0.083 | 0.006 | 0.015 | 0.003 | 0.008 | | | | | I |
| I | B-AD | 0.071 | 0.008 | 0.019 | 0.004 | 0.007 | | | | | I |
| I | C-ABD | 0.112 | 0.003 | | 0.009 | | | | | | I |
| I | D-AB | 0.076 | 0.008 | 0.024 | 0.006 | 0.008 | | | | | I |
| I | D-BC | 0.078 | 0.007 | 0.021 | 0.005 | 0.007 | | | | | I |
| I | A-BCD | 0.107 | 0.005 | | 0.009 | | | | | | I |

| I | TIME | DEMAND (VEH/MIN) | CAPACITY (VEH/MIN) | DEMAND/ CAPACITY (RFC) | PEDESTRIAN FLOW (PEDS/MIN) | START QUEUE (VEHS) | END QUEUE (VEHS) | DELAY (VEH.MIN/ TIME SEGMENT) | GEOMETRIC DELAY (VEH.MIN/ TIME SEGMENT) | AVERAGE DELAY PER ARRIVING VEHICLE (MIN) | I |
|---|--|---------------------|-----------------------|------------------------------|----------------------------------|--------------------------|------------------------|-------------------------------------|---|--|---|
| I | 08.30-08.45 | | | | | | | | | | I |
| I | B-CD | 1.21 | 9.11 | 0.133 | | 0.15 | 0.15 | 2.3 | | 0.13 | I |
| I | B-AD | 1.27 | 6.90 | 0.184 | | 0.22 | 0.22 | 3.3 | | 0.18 | I |
| I | A-BCD | 0.00 | 8.97 | 0.000 | | 0.00 | 0.00 | 0.0 | | 0.00 | I |
| I | D-AB | 0.95 | 9.15 | 0.104 | | 0.11 | 0.12 | 1.7 | | 0.12 | I |
| I | D-BC | 0.94 | 7.71 | 0.122 | | 0.14 | 0.14 | 2.1 | | 0.15 | I |
| I | C-ABD | 1.01 | 10.33 | 0.098 | | 0.11 | 0.11 | 1.7 | | 0.11 | I |
| I | EFFECT ON CAPACITY (PCU/MIN) OF MARGINAL CHANGES IN: | | | | | | | | | | |
| I | MARGINAL | LANE WIDTH | MAJOR RD. | CENT RES | VIS TO LEFT | VISIBILITY | | | | | I |
| I | CHANGE: | (.1M) | WIDTH (.1M) | WIDTH (.1M) | (M) | TO RIGHT (M) | | | | | I |
| I | B-CD | 0.083 | 0.006 | 0.015 | 0.003 | 0.008 | | | | | I |
| I | B-AD | 0.071 | 0.008 | 0.019 | 0.004 | 0.007 | | | | | I |
| I | C-ABD | 0.112 | 0.003 | | 0.009 | | | | | | I |
| I | D-AB | 0.076 | 0.008 | 0.024 | 0.006 | 0.008 | | | | | I |
| I | D-BC | 0.078 | 0.007 | 0.021 | 0.005 | 0.007 | | | | | I |
| I | A-BCD | 0.107 | 0.005 | | 0.009 | | | | | | I |

| TIME | DEMAND (VEH/MIN) | CAPACITY (VEH/MIN) | DEMAND/ CAPACITY (RFC) | PEDESTRIAN FLOW (PEDS/MIN) | START QUEUE (VEHS) | END QUEUE (VEHS) | DELAY (VEH.MIN/ TIME SEGMENT) | GEOMETRIC DELAY (VEH.MIN/ TIME SEGMENT) | AVERAGE DELAY PER ARRIVING VEHICLE (MIN) |
|-------------|---------------------|-----------------------|------------------------------|----------------------------------|--------------------------|------------------------|-------------------------------------|---|--|
| 08.45-09.00 | | | | | | | | | |
| B-CD | 0.98 | 9.46 | 0.103 | | 0.15 | 0.12 | 1.8 | | 0.12 |
| B-AD | 1.05 | 7.22 | 0.145 | | 0.22 | 0.17 | 2.6 | | 0.16 |
| A-BCD | 0.00 | 9.16 | 0.000 | | 0.00 | 0.00 | 0.0 | | 0.00 |
| D-AB | 0.77 | 9.52 | 0.081 | | 0.12 | 0.09 | 1.4 | | 0.11 |
| D-BC | 0.77 | 7.98 | 0.096 | | 0.14 | 0.11 | 1.7 | | 0.14 |
| C-ABD | 0.82 | 10.46 | 0.079 | | 0.11 | 0.09 | 1.3 | | 0.10 |

| EFFECT ON CAPACITY (PCU/MIN) OF MARGINAL CHANGES IN: | | | | | | |
|--|------------|-----------------------------|----------------------------|---|-------------------------------|-------|
| MARGINAL | LANE WIDTH | CAPACITY | PEDESTRIAN | START | END | DELAY |
| CHANGE: | (.1M) | MAJOR RD. WIDTH (.1M) | CENT RES WIDTH (.1M) | VIS TO LEFT (AHEAD FOR MAJOR) (M) | VISIBILITY TO RIGHT (M) | |
| B-CD | 0.086 | 0.005 | 0.014 | 0.003 | | 0.009 |
| B-AD | 0.074 | 0.006 | 0.019 | 0.005 | | 0.007 |
| C-ABD | 0.114 | 0.003 | | 0.009 | | |
| D-AB | 0.079 | 0.006 | 0.024 | 0.006 | | 0.009 |
| D-BC | 0.080 | 0.006 | 0.021 | 0.005 | | 0.007 |
| A-BCD | 0.110 | 0.004 | | 0.009 | | |

| TIME | DEMAND (VEH/MIN) | CAPACITY (VEH/MIN) | DEMAND/ CAPACITY (RFC) | PEDESTRIAN FLOW (PEDS/MIN) | START QUEUE (VEHS) | END QUEUE (VEHS) | DELAY (VEH.MIN/ TIME SEGMENT) | GEOMETRIC DELAY (VEH.MIN/ TIME SEGMENT) | AVERAGE DELAY PER ARRIVING VEHICLE (MIN) |
|-------------|---------------------|-----------------------|------------------------------|----------------------------------|--------------------------|------------------------|-------------------------------------|---|--|
| 09.00-09.15 | | | | | | | | | |
| B-CD | 0.81 | 9.72 | 0.084 | | 0.12 | 0.09 | 1.4 | | 0.11 |
| B-AD | 0.88 | 7.45 | 0.118 | | 0.17 | 0.14 | 2.1 | | 0.15 |
| A-BCD | 0.00 | 9.30 | 0.000 | | 0.00 | 0.00 | 0.0 | | 0.00 |
| D-AB | 0.65 | 9.79 | 0.066 | | 0.09 | 0.07 | 1.1 | | 0.11 |
| D-BC | 0.64 | 8.18 | 0.079 | | 0.11 | 0.09 | 1.3 | | 0.13 |
| C-ABD | 0.69 | 10.55 | 0.065 | | 0.09 | 0.07 | 1.1 | | 0.10 |

| EFFECT ON CAPACITY (PCU/MIN) OF MARGINAL CHANGES IN: | | | | | | |
|--|------------|-----------------------------|----------------------------|---|-------------------------------|-------|
| MARGINAL | LANE WIDTH | CAPACITY | PEDESTRIAN | START | END | DELAY |
| CHANGE: | (.1M) | MAJOR RD. WIDTH (.1M) | CENT RES WIDTH (.1M) | VIS TO LEFT (AHEAD FOR MAJOR) (M) | VISIBILITY TO RIGHT (M) | |
| B-CD | 0.088 | 0.004 | 0.014 | 0.003 | | 0.009 |
| B-AD | 0.076 | 0.005 | 0.019 | 0.005 | | 0.007 |
| C-ABD | 0.115 | 0.002 | | 0.009 | | |
| D-AB | 0.082 | 0.005 | 0.024 | 0.006 | | 0.009 |
| D-BC | 0.082 | 0.005 | 0.021 | 0.005 | | 0.008 |
| A-BCD | 0.111 | 0.004 | | 0.009 | | |

QUEUE FOR STREAM B-CD

| TIME SEGMENT ENDING | NO. OF VEHICLES IN QUEUE |
|------------------------|--------------------------------|
| 08.00 | 0.1 |
| 08.15 | 0.1 |
| 08.30 | 0.2 |
| 08.45 | 0.2 |
| 09.00 | 0.1 |
| 09.15 | 0.1 |

QUEUE FOR STREAM B-AD

| TIME SEGMENT ENDING | NO. OF VEHICLES IN QUEUE |
|------------------------|--------------------------------|
| 08.00 | 0.1 |
| 08.15 | 0.2 |
| 08.30 | 0.2 |
| 08.45 | 0.2 |
| 09.00 | 0.2 |
| 09.15 | 0.1 |

QUEUE FOR STREAM A-BCD

| TIME SEGMENT ENDING | NO. OF VEHICLES IN QUEUE |
|------------------------|--------------------------------|
| 08.00 | 0.0 |
| 08.15 | 0.0 |
| 08.30 | 0.0 |
| 08.45 | 0.0 |
| 09.00 | 0.0 |
| 09.15 | 0.0 |

QUEUE FOR STREAM D-AB

| TIME SEGMENT ENDING | NO. OF VEHICLES IN QUEUE |
|---------------------|--------------------------|
| 08.00 | 0.1 |
| 08.15 | 0.1 |
| 08.30 | 0.1 |
| 08.45 | 0.1 |
| 09.00 | 0.1 |
| 09.15 | 0.1 |

QUEUE FOR STREAM D-BC

| TIME SEGMENT ENDING | NO. OF VEHICLES IN QUEUE |
|---------------------|--------------------------|
| 08.00 | 0.1 |
| 08.15 | 0.1 |
| 08.30 | 0.1 |
| 08.45 | 0.1 |
| 09.00 | 0.1 |
| 09.15 | 0.1 |

QUEUE FOR STREAM C-ABD

| TIME SEGMENT ENDING | NO. OF VEHICLES IN QUEUE |
|---------------------|--------------------------|
| 08.00 | 0.1 |
| 08.15 | 0.1 |
| 08.30 | 0.1 |
| 08.45 | 0.1 |
| 09.00 | 0.1 |
| 09.15 | 0.1 |

QUEUEING DELAY INFORMATION OVER WHOLE PERIOD

| I STREAM | I | I TOTAL DEMAND | I | I * QUEUEING * | I | I * INCLUSIVE QUEUEING * | I |
|----------|---|----------------|-----------|----------------|-------------|--------------------------|-------------|
| I | I | I | I | I * DELAY * | I | I * DELAY * | I |
| I | I | I (VEH) | I (VEH/H) | I (MIN) | I (MIN/VEH) | I (MIN) | I (MIN/VEH) |
| I B-CD | I | 89.9 | I 60.0 | I 10.7 | I 0.12 | I 10.7 | I 0.12 |
| I B-AD | I | 95.9 | I 63.9 | I 15.7 | I 0.16 | I 15.7 | I 0.16 |
| I A-BCD | I | 0.0 | I 0.0 | I 0.0 | I 0.00 | I 0.0 | I 0.00 |
| I D-AB | I | 71.2 | I 47.4 | I 8.2 | I 0.12 | I 8.2 | I 0.12 |
| I D-BC | I | 70.6 | I 47.1 | I 9.8 | I 0.14 | I 9.8 | I 0.14 |
| I C-ABD | I | 75.7 | I 50.5 | I 8.1 | I 0.11 | I 8.1 | I 0.11 |
| I ALL | I | 854.8 | I 569.8 | I 52.4 | I 0.06 | I 52.4 | I 0.06 |

* DELAY IS THAT OCCURRING ONLY WITHIN THE TIME PERIOD .
 * INCLUSIVE DELAY INCLUDES DELAY SUFFERED BY VEHICLES WHICH ARE STILL QUEUEING AFTER THE END OF THE TIME PERIOD.
 * THESE WILL ONLY BE SIGNIFICANTLY DIFFERENT IF THERE IS A LARGE QUEUE REMAINING AT THE END OF THE TIME PERIOD.

END OF JOB

===== end of file =====

TRL LIMITED

(C) COPYRIGHT 2006

CAPACITIES, QUEUES, AND DELAYS AT 3 OR 4-ARM MAJOR/MINOR PRIORITY JUNCTIONS

PICADY 5.0 ANALYSIS PROGRAM
RELEASE 3.0 (JUNE 2006)

ADAPTED FROM PICADY/3 WHICH IS CROWN COPYRIGHT
BY PERMISSION OF THE CONTROLLER OF HMSO

FOR SALES AND DISTRIBUTION INFORMATION,
PROGRAM ADVICE AND MAINTENANCE CONTACT:
TRL SOFTWARE BUREAU
TEL: CROWTHORNE (01344) 770758, FAX: 770864
EMAIL: SoftwareBureau@trl.co.uk

THE USER OF THIS COMPUTER PROGRAM FOR THE SOLUTION OF AN ENGINEERING PROBLEM IS
IN NO WAY RELIEVED OF HIS RESPONSIBILITY FOR THE CORRECTNESS OF THE SOLUTION

Run with file:-

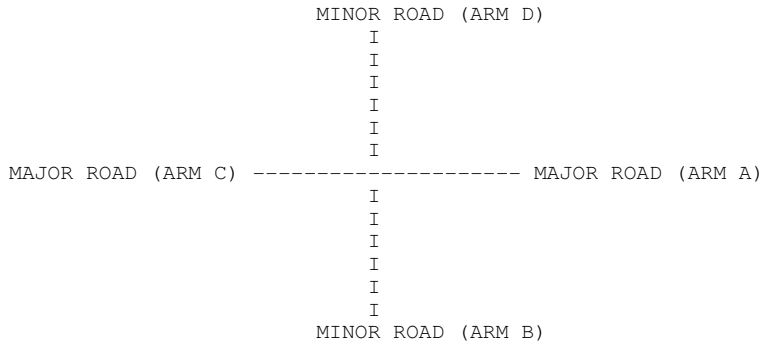
"J:\120000\120669-00\4 Internal Project Data\4-04 Calculations\4-04-06 Junction Analysis\Picady\
Site 4. B4030 Lower Heyford Rd - Port Way\2013 Base + Gen\PM\
Site 4.Lower Heyford - Port Way 2013 Base + Full Development PM.vpi"
(drive-on-the-left) at 12:34:40 on Tuesday, 7 August 2007

RUN INFORMATION

RUN TITLE: Site 4. Lower Heyford Rd - Port Way 2013 Base & Full Development PM
LOCATION: Oxfordshire
DATE: 07/08/07
CLIENT: North Oxfordshire Consortium
ENUMERATOR: Ian Clarke
JOB NUMBER: 120669
STATUS: TIA
DESCRIPTION:

.MAJOR/MINOR JUNCTION CAPACITY AND DELAY

INPUT DATA



ARM A IS Lower Heyford Road (E)
ARM B IS Port Way (S)
ARM C IS Lower Heyford Road (W)
ARM D IS Port Way (N)

STREAM LABELLING CONVENTION

STREAM A-B CONTAINS TRAFFIC GOING FROM ARM A TO ARM B
STREAM B-AC CONTAINS TRAFFIC GOING FROM ARM B TO ARM A AND TO ARM C
ETC.

 GEOMETRIC DATA

| I | DATA ITEM | I | MINOR ROAD B | I | MINOR ROAD D | I |
|---|------------------------------------|---|-----------------|---|-----------------|---|
| I | TOTAL MAJOR ROAD CARRIAGEWAY WIDTH | I | (W) 7.00 M. | I | (W) 7.00 M. | I |
| I | CENTRAL RESERVE WIDTH | I | (WCR) 0.00 M. | I | (WCR) 0.00 M. | I |
| I | | I | | I | | I |
| I | MAJOR ROAD RIGHT TURN - WIDTH | I | (WC-B) 2.20 M. | I | (WA-D) 2.20 M. | I |
| I | - VISIBILITY | I | (VC-B) 150.0 M. | I | (VA-D) 150.0 M. | I |
| I | - BLOCKS TRAFFIC | I | YES | I | YES | I |
| I | | I | | I | | I |
| I | MINOR ROAD - VISIBILITY TO LEFT | I | (VB-C) 38.0 M. | I | (VD-A) 95.0 M. | I |
| I | - VISIBILITY TO RIGHT | I | (VB-A) 72.0 M. | I | (VD-C) 92.0 M. | I |
| I | - LANE 1 WIDTH | I | (WB-C) - | I | (WD-A) - | I |
| I | - LANE 2 WIDTH | I | (WB-A) - | I | (WD-C) - | I |
| I | - WIDTH AT 0 M FROM JUNC. | I | 10.00 M. | I | 10.00 M. | I |
| I | - WIDTH AT 5 M FROM JUNC. | I | 6.00 M. | I | 8.00 M. | I |
| I | - WIDTH AT 10 M FROM JUNC. | I | 4.50 M. | I | 5.80 M. | I |
| I | - WIDTH AT 15 M FROM JUNC. | I | 4.10 M. | I | 4.00 M. | I |
| I | - WIDTH AT 20 M FROM JUNC. | I | 3.70 M. | I | 3.20 M. | I |
| I | - LENGTH OF FLARED SECTION | I | DERIVED: 1 PCU | I | 2 VEHS | I |

.SLOPES AND INTERCPET

(NB:Streams may be combined, in which case capacity will be adjusted)

B-C Stream

| I | Intercept For Stream B-C | Slope For Opposing Stream A-C | Slope For Opposing Stream A-B | I |
|---|--------------------------|-------------------------------|-------------------------------|---|
| I | 615.66 | 0.23 | 0.09 | I |

D-A Stream

| I | Intercept For Stream D-A | Slope For Opposing Stream C-A | Slope For Opposing Stream C-D | I |
|---|--------------------------|-------------------------------|-------------------------------|---|
| I | 627.24 | 0.23 | 0.09 | I |

B-A Stream

| I | Intercept For Stream B-A | Slope For Opposing Stream A-C | Slope For Opposing Stream A-D | Slope For Opposing Stream D-A | Slope For Opposing Stream D-B | I |
|---|--------------------------|-------------------------------|-------------------------------|-------------------------------|-------------------------------|---|
| I | 483.33 | 0.21 | 0.21 | 0.21 | 0.21 | I |

| I | Slope For Opposing Stream A-B | Slope For Opposing Stream C-A | Slope For Opposing Stream C-B | Slope For Opposing Stream D-C | I |
|---|-------------------------------|-------------------------------|-------------------------------|-------------------------------|---|
| I | 0.08 | 0.13 | 0.30 | 0.11 | I |

D-C Stream

| I | Intercept For Stream D-C | Slope For Opposing Stream C-A | Slope For Opposing Stream C-B | Slope For Opposing Stream B-C | Slope For Opposing Stream B-D | I |
|---|--------------------------|-------------------------------|-------------------------------|-------------------------------|-------------------------------|---|
| I | 510.47 | 0.22 | 0.22 | 0.22 | 0.22 | I |

| I | Slope For Opposing Stream C-D | Slope For Opposing Stream A-C | Slope For Opposing Stream A-D | Slope For Opposing Stream B-A | I |
|---|-------------------------------|-------------------------------|-------------------------------|-------------------------------|---|
| I | 0.09 | 0.14 | 0.32 | 0.11 | I |

C-B Stream

| I | Intercept For Stream C-B | Slope For Opposing Stream A-C | Slope For Opposing Stream A-D | I |
|---|--------------------------|-------------------------------|-------------------------------|---|
| I | 660.83 | 0.24 | 0.35 | I |

A-D Stream

| I | Intercept For Stream A-D | Slope For Opposing Stream C-A | Slope For Opposing Stream C-B | I |
|---|--------------------------|-------------------------------|-------------------------------|---|
| I | 660.83 | 0.24 | 0.35 | I |

B-D Stream From Left Hand Lane

| I | Intercept For Stream B-D | Slope For Opposing Stream A-C | Slope For Opposing Stream A-D | Slope For Opposing Stream A-B | Slope For Opposing Stream C-B | I |
|---|--------------------------|-------------------------------|-------------------------------|-------------------------------|-------------------------------|---|
| I | 483.33 | 0.21 | 0.21 | 0.08 | 0.30 | I |

| I | Slope For Opposing Stream C-A | Slope For Opposing Stream C-D | Slope For Opposing Stream C-B | I |
|---|-------------------------------|-------------------------------|-------------------------------|---|
| I | 0.13 | 0.13 | | I |

B-D Stream From Right Hand Lane

| I | Intercept For Stream B-D | Slope For Opposing Stream A-C | Slope For Opposing Stream A-D | Slope For Opposing Stream A-B | Slope For Opposing Stream C-B | I |
|---|--------------------------|-------------------------------|-------------------------------|-------------------------------|-------------------------------|---|
| I | 483.33 | 0.21 | 0.21 | 0.08 | 0.30 | I |

| I | Slope For Opposing Stream C-A | Slope For Opposing Stream C-D | Slope For Opposing Stream C-B | I |
|---|-------------------------------|-------------------------------|-------------------------------|---|
| I | 0.13 | 0.13 | | I |

D-B Stream From Left Hand Lane

| I | Intercept For Stream D-B | Slope For Opposing Stream C-A | Slope For Opposing Stream C-B | Slope For Opposing Stream D-C | Slope For Opposing Stream A-D | I |
|---|--------------------------|-------------------------------|-------------------------------|-------------------------------|-------------------------------|---|
| I | 510.47 | 0.22 | 0.22 | 0.09 | 0.32 | I |

| I | Slope For Opposing Stream A-C | Slope For Opposing Stream A-B | Slope For Opposing Stream C-B | I |
|---|-------------------------------|-------------------------------|-------------------------------|---|
| I | 0.14 | 0.14 | | I |

D-B Stream From Right Hand Lane

| I | Intercept For Stream D-B | Slope For Opposing Stream C-A | Slope For Opposing Stream C-B | Slope For Opposing Stream C-D | Slope For Opposing Stream A-D | I |
|---|--------------------------|-------------------------------|-------------------------------|-------------------------------|-------------------------------|---|
| I | 510.47 | 0.22 | 0.22 | 0.09 | 0.32 | I |

| I | Slope For Opposing Stream A-C | Slope For Opposing Stream A-B | Slope For Opposing Stream C-B | I |
|---|-------------------------------|-------------------------------|-------------------------------|---|
| I | 0.14 | 0.14 | | I |

TRAFFIC DEMAND DATA

| ARM | FLOW SCALE (%) |
|-----|----------------|
| A | 100 |
| B | 100 |
| C | 100 |
| D | 100 |

Demand set: Site 4. Lower Heyford Rd - Port Way 2013 Base AM

TIME PERIOD BEGINS 07.45 AND ENDS 09.15

LENGTH OF TIME PERIOD - 90 MINUTES.
 LENGTH OF TIME SEGMENT - 15 MINUTES.

DEMAND FLOW PROFILES ARE SYNTHESISED FROM TURNING COUNT DATA

| ARM | NUMBER OF MINUTES FROM START WHEN FLOW STARTS TO RISE | TOP OF PEAK IS REACHED | FLOW STOPS FALLING | RATE OF FLOW (VEH/MIN) BEFORE PEAK | AT TOP OF PEAK | AFTER PEAK |
|-------|---|------------------------|--------------------|------------------------------------|----------------|------------|
| ARM A | 15.00 | 45.00 | 75.00 | 2.11 | 3.17 | 2.11 |
| ARM B | 15.00 | 45.00 | 75.00 | 4.63 | 6.94 | 4.63 |
| ARM C | 15.00 | 45.00 | 75.00 | 2.06 | 3.09 | 2.06 |
| ARM D | 15.00 | 45.00 | 75.00 | 0.89 | 1.33 | 0.89 |

| TIME | TURNING PROPORTIONS | | | | |
|---------------|---------------------|--------|--------|--------|--------|
| | FROM/TO | ARM A | ARM B | ARM C | ARM D |
| 07.45 - 09.15 | ARM A | 0.000 | 0.000 | 0.994 | 0.006 |
| | | (0.0) | (0.0) | (0.0) | (0.0) |
| | ARM B | 0.314 | 0.000 | 0.422 | 0.265 |
| | | 116.0 | 0.0 | 156.0 | 98.0 |
| | | (0.0) | (0.0) | (0.0) | (0.0) |
| | ARM C | 0.758 | 0.061 | 0.000 | 0.182 |
| | | 125.0 | 10.0 | 0.0 | 30.0 |
| | | (0.0) | (0.0) | (0.0) | (0.0) |
| | ARM D | 0.014 | 0.958 | 0.028 | 0.000 |
| | | 1.0 | 68.0 | 2.0 | 0.0 |
| | | (0.0) | (0.0) | (0.0) | (0.0) |

TURNING PROPORTIONS ARE CALCULATED FROM TURNING COUNT DATA

QUEUE AND DELAY INFORMATION FOR EACH 15 MIN TIME SEGMENT

FOR COMBINED DEMAND SETS
 AND FOR TIME PERIOD 1

| TIME | DEMAND (VEH/MIN) | CAPACITY (VEH/MIN) | DEMAND/CAPACITY (RFC) | PEDESTRIAN FLOW (PEDS/MIN) | START QUEUE (VEHS) | END QUEUE (VEHS) | DELAY (VEH.MIN/TIME SEGMENT) | GEOMETRIC DELAY (VEH.MIN/TIME SEGMENT) | AVERAGE DELAY PER ARRIVING VEHICLE (MIN) |
|--|------------------|--------------------|-----------------------|----------------------------|--------------------|-------------------------------|------------------------------|--|--|
| 07.45-08.00 | | | | | | | | | |
| B-CD | 2.68 | 9.15 | 0.293 | | 0.00 | 0.41 | 5.8 | | 0.15 |
| B-AD | 1.96 | 8.27 | 0.237 | | 0.00 | 0.31 | 4.4 | | 0.16 |
| A-BCD | 0.01 | 10.49 | 0.001 | | 0.00 | 0.00 | 0.0 | | 0.10 |
| D-AB | 0.44 | 10.09 | 0.044 | | 0.00 | 0.05 | 0.7 | | 0.10 |
| D-BC | 0.45 | 8.35 | 0.054 | | 0.00 | 0.06 | 0.8 | | 0.13 |
| C-ABD | 0.13 | 10.49 | 0.012 | | 0.00 | 0.01 | 0.2 | | 0.10 |
| EFFECT ON CAPACITY (PCU/MIN) OF MARGINAL CHANGES IN: | | | | | | | | | |
| MARGINAL CHANGE: | LANE WIDTH (.1M) | WIDTH (.1M) | MAJOR RD. WIDTH (.1M) | PEDESTRIAN FLOW (M) | CENT RES (M) | VIS TO LEFT (AHEAD FOR MAJOR) | VISIBILITY TO RIGHT (M) | | |
| B-CD | 0.092 | 0.003 | 0.008 | 0.002 | | | 0.008 | | |
| B-AD | 0.078 | 0.005 | 0.021 | 0.005 | | | 0.008 | | |
| C-ABD | 0.114 | 0.002 | | 0.009 | | | | | |
| D-AB | 0.084 | 0.004 | 0.024 | 0.006 | | | 0.009 | | |
| D-BC | 0.084 | 0.004 | 0.021 | 0.005 | | | 0.008 | | |
| A-BCD | 0.114 | 0.002 | | 0.009 | | | | | |

| I | TIME | DEMAND (VEH/MIN) | CAPACITY (VEH/MIN) | DEMAND/ CAPACITY (RFC) | PEDESTRIAN FLOW (PEDS/MIN) | START QUEUE (VEHS) | END QUEUE (VEHS) | DELAY (VEH.MIN/ TIME SEGMENT) | GEOMETRIC DELAY (VEH.MIN/ TIME SEGMENT) | AVERAGE DELAY PER ARRIVING VEHICLE (MIN) | I | |
|---|-------------|---------------------------------|-----------------------|------------------------------|----------------------------------|----------------------------------|------------------------|-------------------------------------|---|--|---|---|
| I | 08.00-08.15 | | | | | | | | | | I | |
| I | B-CD | 3.23 | 8.77 | 0.368 | | 0.41 | 0.57 | 8.3 | | 0.18 | I | |
| I | B-AD | 2.31 | 7.96 | 0.291 | | 0.31 | 0.40 | 5.9 | | 0.18 | I | |
| I | A-BCD | 0.01 | 10.39 | 0.001 | | 0.00 | 0.00 | 0.0 | | 0.10 | I | |
| I | D-AB | 0.53 | 9.88 | 0.053 | | 0.05 | 0.06 | 0.8 | | 0.11 | I | |
| I | D-BC | 0.54 | 8.19 | 0.066 | | 0.06 | 0.07 | 1.0 | | 0.13 | I | |
| I | C-ABD | 0.15 | 10.39 | 0.014 | | 0.01 | 0.01 | 0.2 | | 0.10 | I | |
| I | | | | | | | | | | | I | |
| I | | EFFECT ON CAPACITY (PCU/MIN) OF | | | | | MARGINAL CHANGES IN: | | | | | I |
| I | | MARGINAL | LANE WIDTH | MAJOR RD. WIDTH | CENT RES WIDTH | VIS TO LEFT (AHEAD FOR MAJOR) | VISIBILITY TO RIGHT | | | | I | |
| I | | CHANGE: | (.1M) | (.1M) | (.1M) | (M) | (M) | | | | I | |
| I | | | | | | | | | | | I | |
| I | B-CD | 0.089 | 0.003 | 0.008 | 0.002 | 0.008 | | | | | I | |
| I | B-AD | 0.077 | 0.005 | 0.021 | 0.005 | 0.008 | | | | | I | |
| I | C-ABD | 0.113 | 0.003 | | 0.009 | | | | | | I | |
| I | D-AB | 0.082 | 0.005 | 0.024 | 0.006 | 0.009 | | | | | I | |
| I | D-BC | 0.082 | 0.005 | 0.021 | 0.005 | 0.008 | | | | | I | |
| I | A-BCD | 0.113 | 0.003 | | 0.009 | | | | | | I | |

| I | TIME | DEMAND (VEH/MIN) | CAPACITY (VEH/MIN) | DEMAND/ CAPACITY (RFC) | PEDESTRIAN FLOW (PEDS/MIN) | START QUEUE (VEHS) | END QUEUE (VEHS) | DELAY (VEH.MIN/ TIME SEGMENT) | GEOMETRIC DELAY (VEH.MIN/ TIME SEGMENT) | AVERAGE DELAY PER ARRIVING VEHICLE (MIN) | I | |
|---|-------------|---------------------------------|-----------------------|------------------------------|----------------------------------|----------------------------------|------------------------|-------------------------------------|---|--|---|---|
| I | 08.15-08.30 | | | | | | | | | | I | |
| I | B-CD | 4.01 | 8.16 | 0.491 | | 0.57 | 0.94 | 13.3 | | 0.24 | I | |
| I | B-AD | 2.78 | 7.37 | 0.377 | | 0.40 | 0.59 | 8.5 | | 0.22 | I | |
| I | A-BCD | 0.02 | 10.25 | 0.002 | | 0.00 | 0.00 | 0.0 | | 0.10 | I | |
| I | D-AB | 0.65 | 9.60 | 0.067 | | 0.06 | 0.07 | 1.1 | | 0.11 | I | |
| I | D-BC | 0.66 | 7.96 | 0.083 | | 0.07 | 0.09 | 1.3 | | 0.14 | I | |
| I | C-ABD | 0.18 | 10.25 | 0.018 | | 0.01 | 0.02 | 0.3 | | 0.10 | I | |
| I | | | | | | | | | | | I | |
| I | | EFFECT ON CAPACITY (PCU/MIN) OF | | | | | MARGINAL CHANGES IN: | | | | | I |
| I | | MARGINAL | LANE WIDTH | MAJOR RD. WIDTH | CENT RES WIDTH | VIS TO LEFT (AHEAD FOR MAJOR) | VISIBILITY TO RIGHT | | | | I | |
| I | | CHANGE: | (.1M) | (.1M) | (.1M) | (M) | (M) | | | | I | |
| I | | | | | | | | | | | I | |
| I | B-CD | 0.086 | 0.004 | 0.009 | 0.002 | 0.007 | | | | | I | |
| I | B-AD | 0.074 | 0.007 | 0.021 | 0.005 | 0.007 | | | | | I | |
| I | C-ABD | 0.112 | 0.003 | | 0.009 | | | | | | I | |
| I | D-AB | 0.080 | 0.006 | 0.024 | 0.006 | 0.009 | | | | | I | |
| I | D-BC | 0.080 | 0.006 | 0.021 | 0.005 | 0.007 | | | | | I | |
| I | A-BCD | 0.112 | 0.003 | | 0.009 | | | | | | I | |

| I | TIME | DEMAND (VEH/MIN) | CAPACITY (VEH/MIN) | DEMAND/ CAPACITY (RFC) | PEDESTRIAN FLOW (PEDS/MIN) | START QUEUE (VEHS) | END QUEUE (VEHS) | DELAY (VEH.MIN/ TIME SEGMENT) | GEOMETRIC DELAY (VEH.MIN/ TIME SEGMENT) | AVERAGE DELAY PER ARRIVING VEHICLE (MIN) | I | |
|---|-------------|---------------------------------|-----------------------|------------------------------|----------------------------------|----------------------------------|------------------------|-------------------------------------|---|--|---|---|
| I | 08.30-08.45 | | | | | | | | | | I | |
| I | B-CD | 4.01 | 8.15 | 0.492 | | 0.94 | 0.95 | 14.2 | | 0.24 | I | |
| I | B-AD | 2.78 | 7.36 | 0.378 | | 0.59 | 0.60 | 9.0 | | 0.22 | I | |
| I | A-BCD | 0.02 | 10.25 | 0.002 | | 0.00 | 0.00 | 0.0 | | 0.10 | I | |
| I | D-AB | 0.65 | 9.60 | 0.067 | | 0.07 | 0.07 | 1.1 | | 0.11 | I | |
| I | D-BC | 0.66 | 7.96 | 0.083 | | 0.09 | 0.09 | 1.3 | | 0.14 | I | |
| I | C-ABD | 0.18 | 10.25 | 0.018 | | 0.02 | 0.02 | 0.3 | | 0.10 | I | |
| I | | | | | | | | | | | I | |
| I | | EFFECT ON CAPACITY (PCU/MIN) OF | | | | | MARGINAL CHANGES IN: | | | | | I |
| I | | MARGINAL | LANE WIDTH | MAJOR RD. WIDTH | CENT RES WIDTH | VIS TO LEFT (AHEAD FOR MAJOR) | VISIBILITY TO RIGHT | | | | I | |
| I | | CHANGE: | (.1M) | (.1M) | (.1M) | (M) | (M) | | | | I | |
| I | | | | | | | | | | | I | |
| I | B-CD | 0.086 | 0.004 | 0.009 | 0.002 | 0.007 | | | | | I | |
| I | B-AD | 0.074 | 0.007 | 0.021 | 0.005 | 0.007 | | | | | I | |
| I | C-ABD | 0.112 | 0.003 | | 0.009 | | | | | | I | |
| I | D-AB | 0.080 | 0.006 | 0.024 | 0.006 | 0.009 | | | | | I | |
| I | D-BC | 0.080 | 0.006 | 0.021 | 0.005 | 0.007 | | | | | I | |
| I | A-BCD | 0.112 | 0.003 | | 0.009 | | | | | | I | |

| TIME | DEMAND (VEH/MIN) | CAPACITY (VEH/MIN) | DEMAND/CAPACITY (RFC) | PEDESTRIAN FLOW (PEDS/MIN) | START QUEUE (VEHS) | END QUEUE (VEHS) | DELAY (VEH.MIN/TIME SEGMENT) | GEOMETRIC DELAY (VEH.MIN/TIME SEGMENT) | AVERAGE DELAY PER ARRIVING VEHICLE (MIN) |
|-------------|------------------|--------------------|-----------------------|----------------------------|--------------------|------------------|------------------------------|--|--|
| 08.45-09.00 | | | | | | | | | |
| B-CD | 3.23 | 8.75 | 0.369 | | 0.95 | 0.60 | 9.4 | | 0.18 |
| B-AD | 2.31 | 7.95 | 0.291 | | 0.60 | 0.42 | 6.5 | | 0.18 |
| A-BCD | 0.01 | 10.39 | 0.001 | | 0.00 | 0.00 | 0.0 | | 0.10 |
| D-AB | 0.53 | 9.88 | 0.053 | | 0.07 | 0.06 | 0.9 | | 0.11 |
| D-BC | 0.54 | 8.19 | 0.066 | | 0.09 | 0.07 | 1.1 | | 0.13 |
| C-ABD | 0.15 | 10.39 | 0.014 | | 0.02 | 0.01 | 0.2 | | 0.10 |

| MARGINAL CHANGE: | LANE WIDTH (.1M) | CAPACITY (PCU/MIN) MAJOR RD. WIDTH (.1M) | EFFECT ON CENT RES WIDTH (.1M) | OF VIS TO LEFT (AHEAD FOR MAJOR) (M) | MARGINAL CHANGES IN: VISIBILITY TO RIGHT (M) |
|------------------|------------------|--|--------------------------------|--------------------------------------|--|
| B-CD | 0.089 | 0.003 | 0.008 | 0.002 | 0.008 |
| B-AD | 0.077 | 0.005 | 0.021 | 0.005 | 0.008 |
| C-ABD | 0.113 | 0.003 | | 0.009 | |
| D-AB | 0.082 | 0.005 | 0.024 | 0.006 | 0.009 |
| D-BC | 0.082 | 0.005 | 0.021 | 0.005 | 0.008 |
| A-BCD | 0.113 | 0.003 | | 0.009 | |

| TIME | DEMAND (VEH/MIN) | CAPACITY (VEH/MIN) | DEMAND/CAPACITY (RFC) | PEDESTRIAN FLOW (PEDS/MIN) | START QUEUE (VEHS) | END QUEUE (VEHS) | DELAY (VEH.MIN/TIME SEGMENT) | GEOMETRIC DELAY (VEH.MIN/TIME SEGMENT) | AVERAGE DELAY PER ARRIVING VEHICLE (MIN) |
|-------------|------------------|--------------------|-----------------------|----------------------------|--------------------|------------------|------------------------------|--|--|
| 09.00-09.15 | | | | | | | | | |
| B-CD | 2.68 | 9.13 | 0.294 | | 0.60 | 0.42 | 6.5 | | 0.16 |
| B-AD | 1.96 | 8.26 | 0.237 | | 0.42 | 0.32 | 4.9 | | 0.16 |
| A-BCD | 0.01 | 10.49 | 0.001 | | 0.00 | 0.00 | 0.0 | | 0.10 |
| D-AB | 0.44 | 10.09 | 0.044 | | 0.06 | 0.05 | 0.7 | | 0.10 |
| D-BC | 0.45 | 8.35 | 0.054 | | 0.07 | 0.06 | 0.9 | | 0.13 |
| C-ABD | 0.13 | 10.49 | 0.012 | | 0.01 | 0.01 | 0.2 | | 0.10 |

| MARGINAL CHANGE: | LANE WIDTH (.1M) | CAPACITY (PCU/MIN) MAJOR RD. WIDTH (.1M) | EFFECT ON CENT RES WIDTH (.1M) | OF VIS TO LEFT (AHEAD FOR MAJOR) (M) | MARGINAL CHANGES IN: VISIBILITY TO RIGHT (M) |
|------------------|------------------|--|--------------------------------|--------------------------------------|--|
| B-CD | 0.092 | 0.003 | 0.008 | 0.002 | 0.008 |
| B-AD | 0.078 | 0.005 | 0.021 | 0.005 | 0.008 |
| C-ABD | 0.114 | 0.002 | | 0.009 | |
| D-AB | 0.084 | 0.004 | 0.024 | 0.006 | 0.009 |
| D-BC | 0.084 | 0.004 | 0.021 | 0.005 | 0.008 |
| A-BCD | 0.114 | 0.002 | | 0.009 | |

QUEUE FOR STREAM B-CD

| TIME SEGMENT ENDING | NO. OF VEHICLES IN QUEUE |
|---------------------|--------------------------|
| 08.00 | 0.4 |
| 08.15 | 0.6 * |
| 08.30 | 0.9 * |
| 08.45 | 1.0 * |
| 09.00 | 0.6 * |
| 09.15 | 0.4 |

QUEUE FOR STREAM B-AD

| TIME SEGMENT ENDING | NO. OF VEHICLES IN QUEUE |
|---------------------|--------------------------|
| 08.00 | 0.3 |
| 08.15 | 0.4 |
| 08.30 | 0.6 * |
| 08.45 | 0.6 * |
| 09.00 | 0.4 |
| 09.15 | 0.3 |

QUEUE FOR STREAM A-BCD

| TIME SEGMENT ENDING | NO. OF VEHICLES IN QUEUE |
|---------------------|--------------------------|
| 08.00 | 0.0 |
| 08.15 | 0.0 |
| 08.30 | 0.0 |
| 08.45 | 0.0 |
| 09.00 | 0.0 |
| 09.15 | 0.0 |

TRL LIMITED

(C) COPYRIGHT 2006

CAPACITIES, QUEUES, AND DELAYS AT 3 OR 4-ARM MAJOR/MINOR PRIORITY JUNCTIONS

PICADY 5.0 ANALYSIS PROGRAM
RELEASE 3.0 (JUNE 2006)

ADAPTED FROM PICADY/3 WHICH IS CROWN COPYRIGHT
BY PERMISSION OF THE CONTROLLER OF HMSO

FOR SALES AND DISTRIBUTION INFORMATION,
PROGRAM ADVICE AND MAINTENANCE CONTACT:
TRL SOFTWARE BUREAU
TEL: CROWTHORNE (01344) 770758, FAX: 770864
EMAIL: SoftwareBureau@trl.co.uk

THE USER OF THIS COMPUTER PROGRAM FOR THE SOLUTION OF AN ENGINEERING PROBLEM IS
IN NO WAY RELIEVED OF HIS RESPONSIBILITY FOR THE CORRECTNESS OF THE SOLUTION

Run with file:-
"J:\120000\120669-00\4 Internal Project Data\4-04 Calculations\4-04-06 Junction Analysis\Picady\
Site 9. Ardley Rd - Unnamed Rd\2006 base\AM\Site 9. Ardley Rd - Unnamed Rd 2006 Base AM.vpi"
(drive-on-the-left) at 09:37:24 on Wednesday, 11 July 2007

RUN INFORMATION

RUN TITLE: Site 9. Ardley Rd - Unnamed Rd 2006 Base AM
LOCATION: Oxfordshire
DATE: 09/11/06
CLIENT: North Oxfordshire Consortium
ENUMERATOR: Chris.Morris [MCCPC062011]
JOB NUMBER: 120669
STATUS: TIA
DESCRIPTION:

.MAJOR/MINOR JUNCTION CAPACITY AND DELAY

INPUT DATA

MAJOR ROAD (ARM C) ----- MAJOR ROAD (ARM A)
I
I
I
I
I
I
MINOR ROAD (ARM B)

ARM A IS Ardley Rd (S)
ARM B IS Unnamed Rd (W)
ARM C IS Ardley Rd (N)

STREAM LABELLING CONVENTION

STREAM A-B CONTAINS TRAFFIC GOING FROM ARM A TO ARM B
STREAM B-AC CONTAINS TRAFFIC GOING FROM ARM B TO ARM A AND TO ARM C
ETC.

 GEOMETRIC DATA

| I | DATA ITEM | I | MINOR ROAD B | I |
|---|------------------------------------|---|-----------------|---|
| I | TOTAL MAJOR ROAD CARRIAGEWAY WIDTH | I | (W) 7.80 M. | I |
| I | CENTRAL RESERVE WIDTH | I | (WCR) 0.00 M. | I |
| I | | I | | I |
| I | MAJOR ROAD RIGHT TURN - WIDTH | I | (WC-B) 3.40 M. | I |
| I | - VISIBILITY | I | (VC-B) 100.0 M. | I |
| I | - BLOCKS TRAFFIC | I | YES | I |
| I | | I | | I |
| I | MINOR ROAD - VISIBILITY TO LEFT | I | (VB-C) 100.0 M. | I |
| I | - VISIBILITY TO RIGHT | I | (VB-A) 100.0 M. | I |
| I | - LANE 1 WIDTH | I | (WB-C) - | I |
| I | - LANE 2 WIDTH | I | (WB-A) - | I |
| I | - WIDTH AT 0 M FROM JUNC. | I | 10.00 M. | I |
| I | - WIDTH AT 5 M FROM JUNC. | I | 9.10 M. | I |
| I | - WIDTH AT 10 M FROM JUNC. | I | 4.90 M. | I |
| I | - WIDTH AT 15 M FROM JUNC. | I | 3.00 M. | I |
| I | - WIDTH AT 20 M FROM JUNC. | I | 2.50 M. | I |
| I | - LENGTH OF FLARED SECTION | I | 1 VEHS | I |

 .SLOPES AND INTERCEPT

(NB:Streams may be combined, in which case capacity will be adjusted)

| I | Intercept For Stream B-C | Slope For Opposing Stream A-C | Slope For Opposing Stream A-B | I |
|---|--------------------------|-------------------------------|-------------------------------|---|
| I | 631.87 | 0.23 | 0.09 | I |

| I | Intercept For Stream B-A | Slope For Opposing Stream A-C | Slope For Opposing Stream A-B | Slope For Opposing Stream C-A | Slope For Opposing Stream C-B | I |
|---|--------------------------|-------------------------------|-------------------------------|-------------------------------|-------------------------------|---|
| I | 515.84 | 0.22 | 0.09 | 0.14 | 0.31 | I |

| I | Intercept For Stream C-B | Slope For Opposing Stream A-C | Slope For Opposing Stream A-B | I |
|---|--------------------------|-------------------------------|-------------------------------|---|
| I | 714.40 | 0.26 | 0.26 | I |

NB These values do not allow for any site specific corrections

 TRAFFIC DEMAND DATA

| I | TIME | DEMAND (VEH/MIN) | CAPACITY (VEH/MIN) | DEMAND/ CAPACITY (RFC) | PEDESTRIAN FLOW (PEDS/MIN) | START QUEUE (VEHS) | END QUEUE (VEHS) | DELAY (VEH.MIN/ TIME SEGMENT) | GEOMETRIC DELAY (VEH.MIN/ TIME SEGMENT) | AVERAGE DELAY PER ARRIVING VEHICLE (MIN) | I |
|---|-------------|---------------------|-----------------------|------------------------------|----------------------------------|--------------------------|------------------------|-------------------------------------|---|--|---|
| I | 08.15-08.30 | | | | | | | | | | I |
| I | B-C | 0.55 | 11.23 | 0.049 | | 0.04 | 0.05 | 0.8 | | 0.09 | I |
| I | B-A | 0.00 | 5.66 | 0.000 | | 0.00 | 0.00 | 0.0 | | 0.00 | I |
| I | C-AB | 1.32 | 10.53 | 0.125 | | 0.11 | 0.14 | 2.1 | | 0.11 | I |
| I | A-B | 0.09 | | | | | | | | | I |
| I | A-C | 5.30 | | | | | | | | | I |

| I | TIME | DEMAND (VEH/MIN) | CAPACITY (VEH/MIN) | DEMAND/ CAPACITY (RFC) | PEDESTRIAN FLOW (PEDS/MIN) | START QUEUE (VEHS) | END QUEUE (VEHS) | DELAY (VEH.MIN/ TIME SEGMENT) | GEOMETRIC DELAY (VEH.MIN/ TIME SEGMENT) | AVERAGE DELAY PER ARRIVING VEHICLE (MIN) | I |
|---|-------------|---------------------|-----------------------|------------------------------|----------------------------------|--------------------------|------------------------|-------------------------------------|---|--|---|
| I | 08.30-08.45 | | | | | | | | | | I |
| I | B-C | 0.55 | 11.23 | 0.049 | | 0.05 | 0.05 | 0.8 | | 0.09 | I |
| I | B-A | 0.00 | 5.66 | 0.000 | | 0.00 | 0.00 | 0.0 | | 0.00 | I |
| I | C-AB | 1.32 | 10.53 | 0.125 | | 0.14 | 0.14 | 2.2 | | 0.11 | I |
| I | A-B | 0.09 | | | | | | | | | I |
| I | A-C | 5.30 | | | | | | | | | I |

| I | TIME | DEMAND (VEH/MIN) | CAPACITY (VEH/MIN) | DEMAND/ CAPACITY (RFC) | PEDESTRIAN FLOW (PEDS/MIN) | START QUEUE (VEHS) | END QUEUE (VEHS) | DELAY (VEH.MIN/ TIME SEGMENT) | GEOMETRIC DELAY (VEH.MIN/ TIME SEGMENT) | AVERAGE DELAY PER ARRIVING VEHICLE (MIN) | I |
|---|-------------|---------------------|-----------------------|------------------------------|----------------------------------|--------------------------|------------------------|-------------------------------------|---|--|---|
| I | 08.45-09.00 | | | | | | | | | | I |
| I | B-C | 0.45 | 11.50 | 0.039 | | 0.05 | 0.04 | 0.6 | | 0.09 | I |
| I | B-A | 0.00 | 6.19 | 0.000 | | 0.00 | 0.00 | 0.0 | | 0.00 | I |
| I | C-AB | 1.08 | 10.78 | 0.100 | | 0.14 | 0.11 | 1.7 | | 0.10 | I |
| I | A-B | 0.07 | | | | | | | | | I |
| I | A-C | 4.33 | | | | | | | | | I |

| I | TIME | DEMAND (VEH/MIN) | CAPACITY (VEH/MIN) | DEMAND/ CAPACITY (RFC) | PEDESTRIAN FLOW (PEDS/MIN) | START QUEUE (VEHS) | END QUEUE (VEHS) | DELAY (VEH.MIN/ TIME SEGMENT) | GEOMETRIC DELAY (VEH.MIN/ TIME SEGMENT) | AVERAGE DELAY PER ARRIVING VEHICLE (MIN) | I |
|---|-------------|---------------------|-----------------------|------------------------------|----------------------------------|--------------------------|------------------------|-------------------------------------|---|--|---|
| I | 09.00-09.15 | | | | | | | | | | I |
| I | B-C | 0.38 | 11.69 | 0.032 | | 0.04 | 0.03 | 0.5 | | 0.09 | I |
| I | B-A | 0.00 | 6.57 | 0.000 | | 0.00 | 0.00 | 0.0 | | 0.00 | I |
| I | C-AB | 0.90 | 10.97 | 0.082 | | 0.11 | 0.09 | 1.4 | | 0.10 | I |
| I | A-B | 0.06 | | | | | | | | | I |
| I | A-C | 3.63 | | | | | | | | | I |

QUEUE FOR STREAM B-C

| TIME SEGMENT ENDING | NO. OF VEHICLES IN QUEUE |
|------------------------|--------------------------------|
| 08.00 | 0.0 |
| 08.15 | 0.0 |
| 08.30 | 0.1 |
| 08.45 | 0.1 |
| 09.00 | 0.0 |
| 09.15 | 0.0 |

QUEUE FOR STREAM B-A

| TIME SEGMENT ENDING | NO. OF VEHICLES IN QUEUE |
|------------------------|--------------------------------|
| 08.00 | 0.0 |
| 08.15 | 0.0 |
| 08.30 | 0.0 |
| 08.45 | 0.0 |
| 09.00 | 0.0 |
| 09.15 | 0.0 |

QUEUE FOR STREAM C-AB

| TIME SEGMENT ENDING | NO. OF VEHICLES IN QUEUE |
|---------------------|--------------------------|
| 08.00 | 0.1 |
| 08.15 | 0.1 |
| 08.30 | 0.1 |
| 08.45 | 0.1 |
| 09.00 | 0.1 |
| 09.15 | 0.1 |

QUEUEING DELAY INFORMATION OVER WHOLE PERIOD

| I | STREAM | I | TOTAL DEMAND | | I | * QUEUEING * * DELAY * | | I | * INCLUSIVE QUEUEING * * DELAY * | | I |
|---|--------|---|--------------|---------|---|---------------------------|-----------|---|-------------------------------------|-----------|---|
| I | I | I | (VEH) | (VEH/H) | I | (MIN) | (MIN/VEH) | I | (MIN) | (MIN/VEH) | I |
| I | B-C | I | 41.3 | I 27.5 | I | 3.7 | I 0.09 | I | 3.7 | I 0.09 | I |
| I | B-A | I | 0.0 | I 0.0 | I | 0.0 | I 0.00 | I | 0.0 | I 0.00 | I |
| I | C-AB | I | 99.1 | I 66.1 | I | 10.3 | I 0.10 | I | 10.3 | I 0.10 | I |
| I | A-B | I | 6.9 | I 4.6 | I | | I | I | | I | I |
| I | A-C | I | 397.8 | I 265.2 | I | | I | I | | I | I |
| I | ALL | I | 1253.9 | I 835.9 | I | 14.1 | I 0.01 | I | 14.1 | I 0.01 | I |

* DELAY IS THAT OCCURRING ONLY WITHIN THE TIME PERIOD .
 * INCLUSIVE DELAY INCLUDES DELAY SUFFERED BY VEHICLES WHICH ARE STILL QUEUEING AFTER THE END OF THE TIME PERIOD.
 * THESE WILL ONLY BE SIGNIFICANTLY DIFFERENT IF THERE IS A LARGE QUEUE REMAINING AT THE END OF THE TIME PERIOD.

END OF JOB

===== end of file =====

TRL LIMITED

(C) COPYRIGHT 2006

CAPACITIES, QUEUES, AND DELAYS AT 3 OR 4-ARM MAJOR/MINOR PRIORITY JUNCTIONS

PICADY 5.0 ANALYSIS PROGRAM
RELEASE 3.0 (JUNE 2006)

ADAPTED FROM PICADY/3 WHICH IS CROWN COPYRIGHT
BY PERMISSION OF THE CONTROLLER OF HMSO

FOR SALES AND DISTRIBUTION INFORMATION,
PROGRAM ADVICE AND MAINTENANCE CONTACT:
TRL SOFTWARE BUREAU
TEL: CROWTHORNE (01344) 770758, FAX: 770864
EMAIL: SoftwareBureau@trl.co.uk

THE USER OF THIS COMPUTER PROGRAM FOR THE SOLUTION OF AN ENGINEERING PROBLEM IS
IN NO WAY RELIEVED OF HIS RESPONSIBILITY FOR THE CORRECTNESS OF THE SOLUTION

Run with file:-

"J:\120000\120669-00\4 Internal Project Data\4-04 Calculations\4-04-06 Junction Analysis\Picady\
Site 9. Ardley Rd - Unnamed Rd\2006 base\PM\Site 9. Ardley Rd - Unnamed Rd 2006 Base PM.vpi"
(drive-on-the-left) at 09:42:55 on Wednesday, 11 July 2007

RUN INFORMATION

RUN TITLE: Site 9. Ardley Rd - Unnamed Rd 2006 Base PM
LOCATION: Oxfordshire
DATE: 09/11/06
CLIENT: North Oxfordshire Consortium
ENUMERATOR: Chris.Morris [MCCPC062011]
JOB NUMBER: 120669
STATUS: TIA
DESCRIPTION:

.MAJOR/MINOR JUNCTION CAPACITY AND DELAY

INPUT DATA

MAJOR ROAD (ARM C) ----- MAJOR ROAD (ARM A)
I
I
I
I
I
I
MINOR ROAD (ARM B)

ARM A IS Ardley Rd (S)
ARM B IS Unnamed Rd (W)
ARM C IS Ardley Rd (N)

STREAM LABELLING CONVENTION

STREAM A-B CONTAINS TRAFFIC GOING FROM ARM A TO ARM B
STREAM B-AC CONTAINS TRAFFIC GOING FROM ARM B TO ARM A AND TO ARM C
ETC.

 GEOMETRIC DATA

| I | DATA ITEM | I | MINOR ROAD B | I |
|---|------------------------------------|---|-----------------|---|
| I | TOTAL MAJOR ROAD CARRIAGEWAY WIDTH | I | (W) 7.80 M. | I |
| I | CENTRAL RESERVE WIDTH | I | (WCR) 0.00 M. | I |
| I | | I | | I |
| I | MAJOR ROAD RIGHT TURN - WIDTH | I | (WC-B) 3.40 M. | I |
| I | - VISIBILITY | I | (VC-B) 100.0 M. | I |
| I | - BLOCKS TRAFFIC | I | YES | I |
| I | | I | | I |
| I | MINOR ROAD - VISIBILITY TO LEFT | I | (VB-C) 100.0 M. | I |
| I | - VISIBILITY TO RIGHT | I | (VB-A) 100.0 M. | I |
| I | - LANE 1 WIDTH | I | (WB-C) - | I |
| I | - LANE 2 WIDTH | I | (WB-A) - | I |
| I | - WIDTH AT 0 M FROM JUNC. | I | 10.00 M. | I |
| I | - WIDTH AT 5 M FROM JUNC. | I | 9.10 M. | I |
| I | - WIDTH AT 10 M FROM JUNC. | I | 4.90 M. | I |
| I | - WIDTH AT 15 M FROM JUNC. | I | 3.00 M. | I |
| I | - WIDTH AT 20 M FROM JUNC. | I | 2.50 M. | I |
| I | - LENGTH OF FLARED SECTION | I | 1 VEHS | I |

 .SLOPES AND INTERCEPT

(NB:Streams may be combined, in which case capacity will be adjusted)

| I | Intercept For Stream B-C | Slope For Opposing Stream A-C | Slope For Opposing Stream A-B | I |
|---|--------------------------|-------------------------------|-------------------------------|---|
| I | 631.87 | 0.23 | 0.09 | I |

| I | Intercept For Stream B-A | Slope For Opposing Stream A-C | Slope For Opposing Stream A-B | Slope For Opposing Stream C-A | Slope For Opposing Stream C-B | I |
|---|--------------------------|-------------------------------|-------------------------------|-------------------------------|-------------------------------|---|
| I | 515.84 | 0.22 | 0.09 | 0.14 | 0.31 | I |

| I | Intercept For Stream C-B | Slope For Opposing Stream A-C | Slope For Opposing Stream A-B | I |
|---|--------------------------|-------------------------------|-------------------------------|---|
| I | 714.40 | 0.26 | 0.26 | I |

NB These values do not allow for any site specific corrections

 TRAFFIC DEMAND DATA

| I | TIME | DEMAND (VEH/MIN) | CAPACITY (VEH/MIN) | DEMAND/ CAPACITY (RFC) | PEDESTRIAN FLOW (PEDS/MIN) | START QUEUE (VEHS) | END QUEUE (VEHS) | DELAY (VEH.MIN/ TIME SEGMENT) | GEOMETRIC DELAY (VEH.MIN/ TIME SEGMENT) | AVERAGE DELAY PER ARRIVING VEHICLE (MIN) | I |
|---|-------------|---------------------|-----------------------|------------------------------|----------------------------------|--------------------------|------------------------|-------------------------------------|---|--|---|
| I | 17.15-17.30 | | | | | | | | | | I |
| I | B-C | 0.79 | 10.59 | 0.075 | | 0.06 | 0.08 | 1.2 | | 0.10 | I |
| I | B-A | 0.02 | 6.70 | 0.003 | | 0.00 | 0.00 | 0.0 | | 0.15 | I |
| I | C-AB | 0.37 | 9.96 | 0.037 | | 0.03 | 0.04 | 0.6 | | 0.10 | I |
| I | A-B | 0.00 | | | | | | | | | I |
| I | A-C | 7.62 | | | | | | | | | I |

| I | TIME | DEMAND (VEH/MIN) | CAPACITY (VEH/MIN) | DEMAND/ CAPACITY (RFC) | PEDESTRIAN FLOW (PEDS/MIN) | START QUEUE (VEHS) | END QUEUE (VEHS) | DELAY (VEH.MIN/ TIME SEGMENT) | GEOMETRIC DELAY (VEH.MIN/ TIME SEGMENT) | AVERAGE DELAY PER ARRIVING VEHICLE (MIN) | I |
|---|-------------|---------------------|-----------------------|------------------------------|----------------------------------|--------------------------|------------------------|-------------------------------------|---|--|---|
| I | 17.30-17.45 | | | | | | | | | | I |
| I | B-C | 0.79 | 10.59 | 0.075 | | 0.08 | 0.08 | 1.2 | | 0.10 | I |
| I | B-A | 0.02 | 6.70 | 0.003 | | 0.00 | 0.00 | 0.0 | | 0.15 | I |
| I | C-AB | 0.37 | 9.96 | 0.037 | | 0.04 | 0.04 | 0.6 | | 0.10 | I |
| I | A-B | 0.00 | | | | | | | | | I |
| I | A-C | 7.62 | | | | | | | | | I |

| I | TIME | DEMAND (VEH/MIN) | CAPACITY (VEH/MIN) | DEMAND/ CAPACITY (RFC) | PEDESTRIAN FLOW (PEDS/MIN) | START QUEUE (VEHS) | END QUEUE (VEHS) | DELAY (VEH.MIN/ TIME SEGMENT) | GEOMETRIC DELAY (VEH.MIN/ TIME SEGMENT) | AVERAGE DELAY PER ARRIVING VEHICLE (MIN) | I |
|---|-------------|---------------------|-----------------------|------------------------------|----------------------------------|--------------------------|------------------------|-------------------------------------|---|--|---|
| I | 17.45-18.00 | | | | | | | | | | I |
| I | B-C | 0.64 | 10.97 | 0.059 | | 0.08 | 0.06 | 1.0 | | 0.10 | I |
| I | B-A | 0.01 | 7.20 | 0.002 | | 0.00 | 0.00 | 0.0 | | 0.14 | I |
| I | C-AB | 0.30 | 10.32 | 0.029 | | 0.04 | 0.03 | 0.4 | | 0.10 | I |
| I | A-B | 0.00 | | | | | | | | | I |
| I | A-C | 6.22 | | | | | | | | | I |

| I | TIME | DEMAND (VEH/MIN) | CAPACITY (VEH/MIN) | DEMAND/ CAPACITY (RFC) | PEDESTRIAN FLOW (PEDS/MIN) | START QUEUE (VEHS) | END QUEUE (VEHS) | DELAY (VEH.MIN/ TIME SEGMENT) | GEOMETRIC DELAY (VEH.MIN/ TIME SEGMENT) | AVERAGE DELAY PER ARRIVING VEHICLE (MIN) | I |
|---|-------------|---------------------|-----------------------|------------------------------|----------------------------------|--------------------------|------------------------|-------------------------------------|---|--|---|
| I | 18.00-18.15 | | | | | | | | | | I |
| I | B-C | 0.54 | 11.24 | 0.048 | | 0.06 | 0.05 | 0.8 | | 0.09 | I |
| I | B-A | 0.01 | 7.56 | 0.002 | | 0.00 | 0.00 | 0.0 | | 0.13 | I |
| I | C-AB | 0.25 | 10.58 | 0.024 | | 0.03 | 0.02 | 0.4 | | 0.10 | I |
| I | A-B | 0.00 | | | | | | | | | I |
| I | A-C | 5.21 | | | | | | | | | I |

QUEUE FOR STREAM B-C

| TIME SEGMENT ENDING | NO. OF VEHICLES IN QUEUE |
|------------------------|--------------------------------|
| 17.00 | 0.1 |
| 17.15 | 0.1 |
| 17.30 | 0.1 |
| 17.45 | 0.1 |
| 18.00 | 0.1 |
| 18.15 | 0.1 |

QUEUE FOR STREAM B-A

| TIME SEGMENT ENDING | NO. OF VEHICLES IN QUEUE |
|------------------------|--------------------------------|
| 17.00 | 0.0 |
| 17.15 | 0.0 |
| 17.30 | 0.0 |
| 17.45 | 0.0 |
| 18.00 | 0.0 |
| 18.15 | 0.0 |

QUEUE FOR STREAM C-AB

| TIME SEGMENT ENDING | NO. OF VEHICLES IN QUEUE |
|------------------------|--------------------------------|
| 17.00 | 0.0 |
| 17.15 | 0.0 |
| 17.30 | 0.0 |
| 17.45 | 0.0 |
| 18.00 | 0.0 |
| 18.15 | 0.0 |

QUEUEING DELAY INFORMATION OVER WHOLE PERIOD

| I | STREAM | I | TOTAL DEMAND | I | * QUEUEING * | I | * INCLUSIVE QUEUEING * | I | |
|---|--------|---|--------------|---------|--------------|-----------|------------------------|-----------|---|
| I | I | I | I | I | * DELAY * | I | * DELAY * | I | |
| I | I | I | (VEH) | (VEH/H) | (MIN) | (MIN/VEH) | (MIN) | (MIN/VEH) | |
| I | I | I | I | I | I | I | I | I | |
| I | B-C | I | 59.2 | I 39.5 | I 5.8 | I 0.10 | I 5.8 | I 0.10 | I |
| I | B-A | I | 1.4 | I 0.9 | I 0.2 | I 0.14 | I 0.2 | I 0.14 | I |
| I | C-AB | I | 27.5 | I 18.4 | I 2.8 | I 0.10 | I 2.8 | I 0.10 | I |
| I | A-B | I | 0.0 | I 0.0 | I | I | I | I | I |
| I | A-C | I | 571.2 | I 380.8 | I | I | I | I | I |
| I | ALL | I | 1036.4 | I 691.0 | I 8.7 | I 0.01 | I 8.7 | I 0.01 | I |

* DELAY IS THAT OCCURRING ONLY WITHIN THE TIME PERIOD .
 * INCLUSIVE DELAY INCLUDES DELAY SUFFERED BY VEHICLES WHICH ARE STILL QUEUEING AFTER THE END OF THE TIME PERIOD.
 * THESE WILL ONLY BE SIGNIFICANTLY DIFFERENT IF THERE IS A LARGE QUEUE REMAINING AT THE END OF THE TIME PERIOD.

END OF JOB

===== end of file =====

TRL LIMITED

(C) COPYRIGHT 2006

CAPACITIES, QUEUES, AND DELAYS AT 3 OR 4-ARM MAJOR/MINOR PRIORITY JUNCTIONS

PICADY 5.0 ANALYSIS PROGRAM
RELEASE 3.0 (JUNE 2006)

ADAPTED FROM PICADY/3 WHICH IS CROWN COPYRIGHT
BY PERMISSION OF THE CONTROLLER OF HMSO

FOR SALES AND DISTRIBUTION INFORMATION,
PROGRAM ADVICE AND MAINTENANCE CONTACT:
TRL SOFTWARE BUREAU
TEL: CROWTHORNE (01344) 770758, FAX: 770864
EMAIL: SoftwareBureau@trl.co.uk

THE USER OF THIS COMPUTER PROGRAM FOR THE SOLUTION OF AN ENGINEERING PROBLEM IS
IN NO WAY RELIEVED OF HIS RESPONSIBILITY FOR THE CORRECTNESS OF THE SOLUTION

Run with file:-
"J:\120000\120669-00\4 Internal Project Data\4-04 Calculations\4-04-06 Junction Analysis\Picady\
Site 9. Ardley Rd - Unnamed Rd\2013 Base\AM\Site 9. Ardley Rd - Unnamed Rd 2013 Base AM.vpi"
(drive-on-the-left) at 13:59:22 on Tuesday, 7 August 2007

RUN INFORMATION

RUN TITLE: Site 9. Ardley Rd - Unnamed Rd 2013 Base AM
LOCATION: Oxfordshire
DATE: 07/08/07
CLIENT: North Oxfordshire Consortium
ENUMERATOR: Ian Clarke
JOB NUMBER: 120669
STATUS: TIA
DESCRIPTION:

.MAJOR/MINOR JUNCTION CAPACITY AND DELAY

INPUT DATA

MAJOR ROAD (ARM C) ----- MAJOR ROAD (ARM A)
I
I
I
I
I
I
MINOR ROAD (ARM B)

ARM A IS Ardley Rd (S)
ARM B IS Unnamed Rd (W)
ARM C IS Ardley Rd (N)

STREAM LABELLING CONVENTION

STREAM A-B CONTAINS TRAFFIC GOING FROM ARM A TO ARM B
STREAM B-AC CONTAINS TRAFFIC GOING FROM ARM B TO ARM A AND TO ARM C
ETC.

 GEOMETRIC DATA

| I | DATA ITEM | I | MINOR ROAD B | I |
|---|------------------------------------|---|-----------------|---|
| I | TOTAL MAJOR ROAD CARRIAGEWAY WIDTH | I | (W) 7.80 M. | I |
| I | CENTRAL RESERVE WIDTH | I | (WCR) 0.00 M. | I |
| I | | I | | I |
| I | MAJOR ROAD RIGHT TURN - WIDTH | I | (WC-B) 3.40 M. | I |
| I | - VISIBILITY | I | (VC-B) 100.0 M. | I |
| I | - BLOCKS TRAFFIC | I | YES | I |
| I | | I | | I |
| I | MINOR ROAD - VISIBILITY TO LEFT | I | (VB-C) 100.0 M. | I |
| I | - VISIBILITY TO RIGHT | I | (VB-A) 100.0 M. | I |
| I | - LANE 1 WIDTH | I | (WB-C) - | I |
| I | - LANE 2 WIDTH | I | (WB-A) - | I |
| I | - WIDTH AT 0 M FROM JUNC. | I | 10.00 M. | I |
| I | - WIDTH AT 5 M FROM JUNC. | I | 9.10 M. | I |
| I | - WIDTH AT 10 M FROM JUNC. | I | 4.90 M. | I |
| I | - WIDTH AT 15 M FROM JUNC. | I | 3.00 M. | I |
| I | - WIDTH AT 20 M FROM JUNC. | I | 2.50 M. | I |
| I | - LENGTH OF FLARED SECTION | I | 1 VEHS | I |

 .SLOPES AND INTERCEPT

(NB:Streams may be combined, in which case capacity will be adjusted)

| I | Intercept For Stream B-C | Slope For Opposing Stream A-C | Slope For Opposing Stream A-B | I |
|---|--------------------------|-------------------------------|-------------------------------|---|
| I | 631.87 | 0.23 | 0.09 | I |

| I | Intercept For Stream B-A | Slope For Opposing Stream A-C | Slope For Opposing Stream A-B | Slope For Opposing Stream C-A | Slope For Opposing Stream C-B | I |
|---|--------------------------|-------------------------------|-------------------------------|-------------------------------|-------------------------------|---|
| I | 515.84 | 0.22 | 0.09 | 0.14 | 0.31 | I |

| I | Intercept For Stream C-B | Slope For Opposing Stream A-C | Slope For Opposing Stream A-B | I |
|---|--------------------------|-------------------------------|-------------------------------|---|
| I | 714.40 | 0.26 | 0.26 | I |

NB These values do not allow for any site specific corrections

 TRAFFIC DEMAND DATA

| I | TIME | DEMAND (VEH/MIN) | CAPACITY (VEH/MIN) | DEMAND/ CAPACITY (RFC) | PEDESTRIAN FLOW (PEDS/MIN) | START QUEUE (VEHS) | END QUEUE (VEHS) | DELAY (VEH.MIN/ TIME SEGMENT) | GEOMETRIC DELAY (VEH.MIN/ TIME SEGMENT) | AVERAGE DELAY PER ARRIVING VEHICLE (MIN) | I |
|---|-------------|---------------------|-----------------------|------------------------------|----------------------------------|--------------------------|------------------------|-------------------------------------|---|--|---|
| I | 08.15-08.30 | | | | | | | | | | I |
| I | B-C | 0.61 | 11.05 | 0.055 | | 0.05 | 0.06 | 0.8 | | 0.10 | I |
| I | B-A | 0.00 | 5.30 | 0.000 | | 0.00 | 0.00 | 0.0 | | 0.00 | I |
| I | C-AB | 1.49 | 10.36 | 0.144 | | 0.13 | 0.17 | 2.5 | | 0.11 | I |
| I | A-B | 0.11 | | | | | | | | | I |
| I | A-C | 5.96 | | | | | | | | | I |

| I | TIME | DEMAND (VEH/MIN) | CAPACITY (VEH/MIN) | DEMAND/ CAPACITY (RFC) | PEDESTRIAN FLOW (PEDS/MIN) | START QUEUE (VEHS) | END QUEUE (VEHS) | DELAY (VEH.MIN/ TIME SEGMENT) | GEOMETRIC DELAY (VEH.MIN/ TIME SEGMENT) | AVERAGE DELAY PER ARRIVING VEHICLE (MIN) | I |
|---|-------------|---------------------|-----------------------|------------------------------|----------------------------------|--------------------------|------------------------|-------------------------------------|---|--|---|
| I | 08.30-08.45 | | | | | | | | | | I |
| I | B-C | 0.61 | 11.05 | 0.055 | | 0.06 | 0.06 | 0.9 | | 0.10 | I |
| I | B-A | 0.00 | 5.30 | 0.000 | | 0.00 | 0.00 | 0.0 | | 0.00 | I |
| I | C-AB | 1.49 | 10.36 | 0.144 | | 0.17 | 0.17 | 2.5 | | 0.11 | I |
| I | A-B | 0.11 | | | | | | | | | I |
| I | A-C | 5.96 | | | | | | | | | I |

| I | TIME | DEMAND (VEH/MIN) | CAPACITY (VEH/MIN) | DEMAND/ CAPACITY (RFC) | PEDESTRIAN FLOW (PEDS/MIN) | START QUEUE (VEHS) | END QUEUE (VEHS) | DELAY (VEH.MIN/ TIME SEGMENT) | GEOMETRIC DELAY (VEH.MIN/ TIME SEGMENT) | AVERAGE DELAY PER ARRIVING VEHICLE (MIN) | I |
|---|-------------|---------------------|-----------------------|------------------------------|----------------------------------|--------------------------|------------------------|-------------------------------------|---|--|---|
| I | 08.45-09.00 | | | | | | | | | | I |
| I | B-C | 0.49 | 11.35 | 0.044 | | 0.06 | 0.05 | 0.7 | | 0.09 | I |
| I | B-A | 0.00 | 5.89 | 0.000 | | 0.00 | 0.00 | 0.0 | | 0.00 | I |
| I | C-AB | 1.21 | 10.64 | 0.114 | | 0.17 | 0.13 | 1.9 | | 0.11 | I |
| I | A-B | 0.09 | | | | | | | | | I |
| I | A-C | 4.87 | | | | | | | | | I |

| I | TIME | DEMAND (VEH/MIN) | CAPACITY (VEH/MIN) | DEMAND/ CAPACITY (RFC) | PEDESTRIAN FLOW (PEDS/MIN) | START QUEUE (VEHS) | END QUEUE (VEHS) | DELAY (VEH.MIN/ TIME SEGMENT) | GEOMETRIC DELAY (VEH.MIN/ TIME SEGMENT) | AVERAGE DELAY PER ARRIVING VEHICLE (MIN) | I |
|---|-------------|---------------------|-----------------------|------------------------------|----------------------------------|--------------------------|------------------------|-------------------------------------|---|--|---|
| I | 09.00-09.15 | | | | | | | | | | I |
| I | B-C | 0.41 | 11.57 | 0.036 | | 0.05 | 0.04 | 0.6 | | 0.09 | I |
| I | B-A | 0.00 | 6.32 | 0.000 | | 0.00 | 0.00 | 0.0 | | 0.00 | I |
| I | C-AB | 1.02 | 10.85 | 0.094 | | 0.13 | 0.10 | 1.6 | | 0.10 | I |
| I | A-B | 0.08 | | | | | | | | | I |
| I | A-C | 4.08 | | | | | | | | | I |

QUEUE FOR STREAM B-C

| TIME SEGMENT ENDING | NO. OF VEHICLES IN QUEUE |
|------------------------|--------------------------------|
| 08.00 | 0.0 |
| 08.15 | 0.0 |
| 08.30 | 0.1 |
| 08.45 | 0.1 |
| 09.00 | 0.0 |
| 09.15 | 0.0 |

QUEUE FOR STREAM B-A

| TIME SEGMENT ENDING | NO. OF VEHICLES IN QUEUE |
|------------------------|--------------------------------|
| 08.00 | 0.0 |
| 08.15 | 0.0 |
| 08.30 | 0.0 |
| 08.45 | 0.0 |
| 09.00 | 0.0 |
| 09.15 | 0.0 |

QUEUE FOR STREAM C-AB

| TIME SEGMENT ENDING | NO. OF VEHICLES IN QUEUE |
|---------------------|--------------------------|
| 08.00 | 0.1 |
| 08.15 | 0.1 |
| 08.30 | 0.2 |
| 08.45 | 0.2 |
| 09.00 | 0.1 |
| 09.15 | 0.1 |

QUEUEING DELAY INFORMATION OVER WHOLE PERIOD

| I | STREAM | I | TOTAL DEMAND | I | * QUEUEING * | I | * INCLUSIVE QUEUEING * | I | | |
|---|--------|-----------|--------------|-------|--------------|-----------|------------------------|-----------|------|---|
| I | I | I | I | I | * DELAY * | I | * DELAY * | I | | |
| I | I | (VEH) | (VEH/H) | I | (MIN) | (MIN/VEH) | I | (MIN) | | |
| I | I | (MIN/VEH) | I | (MIN) | (MIN/VEH) | I | (MIN) | (MIN/VEH) | | |
| I | B-C | I | 45.4 | I | 30.3 | I | 4.2 | I | 0.09 | I |
| I | B-A | I | 0.0 | I | 0.0 | I | 0.0 | I | 0.00 | I |
| I | C-AB | I | 111.5 | I | 74.3 | I | 12.0 | I | 0.11 | I |
| I | A-B | I | 8.3 | I | 5.5 | I | | I | | I |
| I | A-C | I | 447.3 | I | 298.2 | I | | I | | I |
| I | ALL | I | 1410.8 | I | 940.6 | I | 16.2 | I | 0.01 | I |

* DELAY IS THAT OCCURRING ONLY WITHIN THE TIME PERIOD .
 * INCLUSIVE DELAY INCLUDES DELAY SUFFERED BY VEHICLES WHICH ARE STILL QUEUEING AFTER THE END OF THE TIME PERIOD.
 * THESE WILL ONLY BE SIGNIFICANTLY DIFFERENT IF THERE IS A LARGE QUEUE REMAINING AT THE END OF THE TIME PERIOD.

END OF JOB

===== end of file =====

TRL LIMITED

(C) COPYRIGHT 2006

CAPACITIES, QUEUES, AND DELAYS AT 3 OR 4-ARM MAJOR/MINOR PRIORITY JUNCTIONS

PICADY 5.0 ANALYSIS PROGRAM
RELEASE 3.0 (JUNE 2006)

ADAPTED FROM PICADY/3 WHICH IS CROWN COPYRIGHT
BY PERMISSION OF THE CONTROLLER OF HMSO

FOR SALES AND DISTRIBUTION INFORMATION,
PROGRAM ADVICE AND MAINTENANCE CONTACT:
TRL SOFTWARE BUREAU
TEL: CROWTHORNE (01344) 770758, FAX: 770864
EMAIL: SoftwareBureau@trl.co.uk

THE USER OF THIS COMPUTER PROGRAM FOR THE SOLUTION OF AN ENGINEERING PROBLEM IS
IN NO WAY RELIEVED OF HIS RESPONSIBILITY FOR THE CORRECTNESS OF THE SOLUTION

Run with file:-
"J:\120000\120669-00\4 Internal Project Data\4-04 Calculations\4-04-06 Junction Analysis\Picady\
Site 9. Ardley Rd - Unnamed Rd\2013 Base\PM\Site 9. Ardley Rd - Unnamed Rd 2013 Base PM.vpi"
(drive-on-the-left) at 14:05:34 on Tuesday, 7 August 2007

RUN INFORMATION

RUN TITLE: Site 9. Ardley Rd - Unnamed Rd 2013 Base PM
LOCATION: Oxfordshire
DATE: 07/08/07
CLIENT: North Oxfordshire Consortium
ENUMERATOR: Ian Clarke
JOB NUMBER: 120669
STATUS: TIA
DESCRIPTION:

.MAJOR/MINOR JUNCTION CAPACITY AND DELAY

INPUT DATA

MAJOR ROAD (ARM C) ----- MAJOR ROAD (ARM A)
I
I
I
I
I
I
MINOR ROAD (ARM B)

ARM A IS Ardley Rd (S)
ARM B IS Unnamed Rd (W)
ARM C IS Ardley Rd (N)

STREAM LABELLING CONVENTION

STREAM A-B CONTAINS TRAFFIC GOING FROM ARM A TO ARM B
STREAM B-AC CONTAINS TRAFFIC GOING FROM ARM B TO ARM A AND TO ARM C
ETC.

 GEOMETRIC DATA

| I | DATA ITEM | I | MINOR ROAD B | I |
|---|------------------------------------|---|-----------------|---|
| I | TOTAL MAJOR ROAD CARRIAGEWAY WIDTH | I | (W) 7.80 M. | I |
| I | CENTRAL RESERVE WIDTH | I | (WCR) 0.00 M. | I |
| I | | I | | I |
| I | MAJOR ROAD RIGHT TURN - WIDTH | I | (WC-B) 3.40 M. | I |
| I | - VISIBILITY | I | (VC-B) 100.0 M. | I |
| I | - BLOCKS TRAFFIC | I | YES | I |
| I | | I | | I |
| I | MINOR ROAD - VISIBILITY TO LEFT | I | (VB-C) 100.0 M. | I |
| I | - VISIBILITY TO RIGHT | I | (VB-A) 100.0 M. | I |
| I | - LANE 1 WIDTH | I | (WB-C) - | I |
| I | - LANE 2 WIDTH | I | (WB-A) - | I |
| I | - WIDTH AT 0 M FROM JUNC. | I | 10.00 M. | I |
| I | - WIDTH AT 5 M FROM JUNC. | I | 9.10 M. | I |
| I | - WIDTH AT 10 M FROM JUNC. | I | 4.90 M. | I |
| I | - WIDTH AT 15 M FROM JUNC. | I | 3.00 M. | I |
| I | - WIDTH AT 20 M FROM JUNC. | I | 2.50 M. | I |
| I | - LENGTH OF FLARED SECTION | I | 1 VEHS | I |

 .SLOPES AND INTERCEPT

(NB:Streams may be combined, in which case capacity will be adjusted)

| I | Intercept For Stream B-C | Slope For Opposing Stream A-C | Slope For Opposing Stream A-B | I |
|---|--------------------------|-------------------------------|-------------------------------|---|
| I | 631.87 | 0.23 | 0.09 | I |

| I | Intercept For Stream B-A | Slope For Opposing Stream A-C | Slope For Opposing Stream A-B | Slope For Opposing Stream C-A | Slope For Opposing Stream C-B | I |
|---|--------------------------|-------------------------------|-------------------------------|-------------------------------|-------------------------------|---|
| I | 515.84 | 0.22 | 0.09 | 0.14 | 0.31 | I |

| I | Intercept For Stream C-B | Slope For Opposing Stream A-C | Slope For Opposing Stream A-B | I |
|---|--------------------------|-------------------------------|-------------------------------|---|
| I | 714.40 | 0.26 | 0.26 | I |

NB These values do not allow for any site specific corrections

 TRAFFIC DEMAND DATA

| I | TIME | DEMAND (VEH/MIN) | CAPACITY (VEH/MIN) | DEMAND/ CAPACITY (RFC) | PEDESTRIAN FLOW (PEDS/MIN) | START QUEUE (VEHS) | END QUEUE (VEHS) | DELAY (VEH.MIN/ TIME SEGMENT) | GEOMETRIC DELAY (VEH.MIN/ TIME SEGMENT) | AVERAGE DELAY PER ARRIVING VEHICLE (MIN) | I |
|---|-------------|---------------------|-----------------------|------------------------------|----------------------------------|--------------------------|------------------------|-------------------------------------|---|--|---|
| I | 08.15-08.30 | | | | | | | | | | I |
| I | B-C | 0.88 | 10.32 | 0.085 | | 0.07 | 0.09 | 1.4 | | 0.11 | I |
| I | B-A | 0.02 | 6.35 | 0.003 | | 0.00 | 0.00 | 0.0 | | 0.16 | I |
| I | C-AB | 0.42 | 9.71 | 0.043 | | 0.04 | 0.05 | 0.7 | | 0.11 | I |
| I | A-B | 0.02 | | | | | | | | | I |
| I | A-C | 8.59 | | | | | | | | | I |

| I | TIME | DEMAND (VEH/MIN) | CAPACITY (VEH/MIN) | DEMAND/ CAPACITY (RFC) | PEDESTRIAN FLOW (PEDS/MIN) | START QUEUE (VEHS) | END QUEUE (VEHS) | DELAY (VEH.MIN/ TIME SEGMENT) | GEOMETRIC DELAY (VEH.MIN/ TIME SEGMENT) | AVERAGE DELAY PER ARRIVING VEHICLE (MIN) | I |
|---|-------------|---------------------|-----------------------|------------------------------|----------------------------------|--------------------------|------------------------|-------------------------------------|---|--|---|
| I | 08.30-08.45 | | | | | | | | | | I |
| I | B-C | 0.88 | 10.32 | 0.085 | | 0.09 | 0.09 | 1.4 | | 0.11 | I |
| I | B-A | 0.02 | 6.35 | 0.003 | | 0.00 | 0.00 | 0.0 | | 0.16 | I |
| I | C-AB | 0.42 | 9.71 | 0.043 | | 0.05 | 0.05 | 0.7 | | 0.11 | I |
| I | A-B | 0.02 | | | | | | | | | I |
| I | A-C | 8.59 | | | | | | | | | I |

| I | TIME | DEMAND (VEH/MIN) | CAPACITY (VEH/MIN) | DEMAND/ CAPACITY (RFC) | PEDESTRIAN FLOW (PEDS/MIN) | START QUEUE (VEHS) | END QUEUE (VEHS) | DELAY (VEH.MIN/ TIME SEGMENT) | GEOMETRIC DELAY (VEH.MIN/ TIME SEGMENT) | AVERAGE DELAY PER ARRIVING VEHICLE (MIN) | I |
|---|-------------|---------------------|-----------------------|------------------------------|----------------------------------|--------------------------|------------------------|-------------------------------------|---|--|---|
| I | 08.45-09.00 | | | | | | | | | | I |
| I | B-C | 0.72 | 10.75 | 0.067 | | 0.09 | 0.07 | 1.1 | | 0.10 | I |
| I | B-A | 0.01 | 6.91 | 0.002 | | 0.00 | 0.00 | 0.0 | | 0.15 | I |
| I | C-AB | 0.34 | 10.11 | 0.034 | | 0.05 | 0.04 | 0.5 | | 0.10 | I |
| I | A-B | 0.01 | | | | | | | | | I |
| I | A-C | 7.01 | | | | | | | | | I |

| I | TIME | DEMAND (VEH/MIN) | CAPACITY (VEH/MIN) | DEMAND/ CAPACITY (RFC) | PEDESTRIAN FLOW (PEDS/MIN) | START QUEUE (VEHS) | END QUEUE (VEHS) | DELAY (VEH.MIN/ TIME SEGMENT) | GEOMETRIC DELAY (VEH.MIN/ TIME SEGMENT) | AVERAGE DELAY PER ARRIVING VEHICLE (MIN) | I |
|---|-------------|---------------------|-----------------------|------------------------------|----------------------------------|--------------------------|------------------------|-------------------------------------|---|--|---|
| I | 09.00-09.15 | | | | | | | | | | I |
| I | B-C | 0.60 | 11.06 | 0.054 | | 0.07 | 0.06 | 0.9 | | 0.10 | I |
| I | B-A | 0.01 | 7.32 | 0.002 | | 0.00 | 0.00 | 0.0 | | 0.14 | I |
| I | C-AB | 0.29 | 10.41 | 0.028 | | 0.04 | 0.03 | 0.4 | | 0.10 | I |
| I | A-B | 0.01 | | | | | | | | | I |
| I | A-C | 5.87 | | | | | | | | | I |

QUEUE FOR STREAM B-C

| TIME SEGMENT ENDING | NO. OF VEHICLES IN QUEUE |
|------------------------|--------------------------------|
| 08.00 | 0.1 |
| 08.15 | 0.1 |
| 08.30 | 0.1 |
| 08.45 | 0.1 |
| 09.00 | 0.1 |
| 09.15 | 0.1 |

QUEUE FOR STREAM B-A

| TIME SEGMENT ENDING | NO. OF VEHICLES IN QUEUE |
|------------------------|--------------------------------|
| 08.00 | 0.0 |
| 08.15 | 0.0 |
| 08.30 | 0.0 |
| 08.45 | 0.0 |
| 09.00 | 0.0 |
| 09.15 | 0.0 |

QUEUE FOR STREAM C-AB

| TIME SEGMENT ENDING | NO. OF VEHICLES IN QUEUE |
|---------------------|--------------------------|
| 08.00 | 0.0 |
| 08.15 | 0.0 |
| 08.30 | 0.0 |
| 08.45 | 0.0 |
| 09.00 | 0.0 |
| 09.15 | 0.0 |

QUEUEING DELAY INFORMATION OVER WHOLE PERIOD

| I STREAM | I | TOTAL DEMAND | I | * QUEUEING * | I | * INCLUSIVE QUEUEING * | I |
|----------|---|--------------|---------|--------------|-----------|------------------------|-----------|
| I | I | (VEH) | (VEH/H) | (MIN) | (MIN/VEH) | (MIN) | (MIN/VEH) |
| I B-C | I | 66.1 | I 44.0 | I 6.6 | I 0.10 | I 6.6 | I 0.10 |
| I B-A | I | 1.4 | I 0.9 | I 0.2 | I 0.15 | I 0.2 | I 0.15 |
| I C-AB | I | 31.7 | I 21.1 | I 3.3 | I 0.10 | I 3.3 | I 0.10 |
| I A-B | I | 1.4 | I 0.9 | I | I | I | I |
| I A-C | I | 644.2 | I 429.4 | I | I | I | I |
| I ALL | I | 1170.0 | I 780.0 | I 10.1 | I 0.01 | I 10.1 | I 0.01 |

* DELAY IS THAT OCCURRING ONLY WITHIN THE TIME PERIOD .
 * INCLUSIVE DELAY INCLUDES DELAY SUFFERED BY VEHICLES WHICH ARE STILL QUEUEING AFTER THE END OF THE TIME PERIOD.
 * THESE WILL ONLY BE SIGNIFICANTLY DIFFERENT IF THERE IS A LARGE QUEUE REMAINING AT THE END OF THE TIME PERIOD.

END OF JOB

===== end of file =====

TRL LIMITED

(C) COPYRIGHT 2006

CAPACITIES, QUEUES, AND DELAYS AT 3 OR 4-ARM MAJOR/MINOR PRIORITY JUNCTIONS

PICADY 5.0 ANALYSIS PROGRAM
RELEASE 3.0 (JUNE 2006)

ADAPTED FROM PICADY/3 WHICH IS CROWN COPYRIGHT
BY PERMISSION OF THE CONTROLLER OF HMSO

FOR SALES AND DISTRIBUTION INFORMATION,
PROGRAM ADVICE AND MAINTENANCE CONTACT:
TRL SOFTWARE BUREAU
TEL: CROWTHORNE (01344) 770758, FAX: 770864
EMAIL: SoftwareBureau@trl.co.uk

THE USER OF THIS COMPUTER PROGRAM FOR THE SOLUTION OF AN ENGINEERING PROBLEM IS
IN NO WAY RELIEVED OF HIS RESPONSIBILITY FOR THE CORRECTNESS OF THE SOLUTION

Run with file:-

"J:\120000\120669-00\4 Internal Project Data\4-04 Calculations\4-04-06 Junction Analysis\Picady\
Site 9. Ardley Rd - Unnamed Rd\2013 Base + Gen\AM\Site 9. Ardley Rd - Unnamed Rd 2013 Base + Gen AM.vpi"
(drive-on-the-left) at 13:43:29 on Tuesday, 7 August 2007

RUN INFORMATION

RUN TITLE: Site 9. Ardley Rd - Unnamed Rd 2013 Base + Full Development AM
LOCATION: Oxfordshire
DATE: 07/08/07
CLIENT: North Oxfordshire Consortium
ENUMERATOR: Ian Clarke
JOB NUMBER: 120669
STATUS: TIA
DESCRIPTION:

.MAJOR/MINOR JUNCTION CAPACITY AND DELAY

INPUT DATA

MAJOR ROAD (ARM C) ----- MAJOR ROAD (ARM A)
I
I
I
I
I
I
MINOR ROAD (ARM B)

ARM A IS Ardley Rd (S)
ARM B IS Unnamed Rd (W)
ARM C IS Ardley Rd (N)

STREAM LABELLING CONVENTION

STREAM A-B CONTAINS TRAFFIC GOING FROM ARM A TO ARM B
STREAM B-AC CONTAINS TRAFFIC GOING FROM ARM B TO ARM A AND TO ARM C
ETC.

 GEOMETRIC DATA

| I | DATA ITEM | I | MINOR ROAD B | I |
|---|------------------------------------|---|-----------------|---|
| I | TOTAL MAJOR ROAD CARRIAGEWAY WIDTH | I | (W) 7.80 M. | I |
| I | CENTRAL RESERVE WIDTH | I | (WCR) 0.00 M. | I |
| I | | I | | I |
| I | MAJOR ROAD RIGHT TURN - WIDTH | I | (WC-B) 3.40 M. | I |
| I | - VISIBILITY | I | (VC-B) 100.0 M. | I |
| I | - BLOCKS TRAFFIC | I | YES | I |
| I | | I | | I |
| I | MINOR ROAD - VISIBILITY TO LEFT | I | (VB-C) 100.0 M. | I |
| I | - VISIBILITY TO RIGHT | I | (VB-A) 100.0 M. | I |
| I | - LANE 1 WIDTH | I | (WB-C) - | I |
| I | - LANE 2 WIDTH | I | (WB-A) - | I |
| I | - WIDTH AT 0 M FROM JUNC. | I | 10.00 M. | I |
| I | - WIDTH AT 5 M FROM JUNC. | I | 9.10 M. | I |
| I | - WIDTH AT 10 M FROM JUNC. | I | 4.90 M. | I |
| I | - WIDTH AT 15 M FROM JUNC. | I | 3.00 M. | I |
| I | - WIDTH AT 20 M FROM JUNC. | I | 2.50 M. | I |
| I | - LENGTH OF FLARED SECTION | I | 1 VEHS | I |

 .SLOPES AND INTERCEPT

(NB:Streams may be combined, in which case capacity will be adjusted)

| I | Intercept For Stream B-C | Slope For Opposing Stream A-C | Slope For Opposing Stream A-B | I |
|---|--------------------------|-------------------------------|-------------------------------|---|
| I | 631.87 | 0.23 | 0.09 | I |

| I | Intercept For Stream B-A | Slope For Opposing Stream A-C | Slope For Opposing Stream A-B | Slope For Opposing Stream C-A | Slope For Opposing Stream C-B | I |
|---|--------------------------|-------------------------------|-------------------------------|-------------------------------|-------------------------------|---|
| I | 515.84 | 0.22 | 0.09 | 0.14 | 0.31 | I |

| I | Intercept For Stream C-B | Slope For Opposing Stream A-C | Slope For Opposing Stream A-B | I |
|---|--------------------------|-------------------------------|-------------------------------|---|
| I | 714.40 | 0.26 | 0.26 | I |

NB These values do not allow for any site specific corrections

 TRAFFIC DEMAND DATA

| I | TIME | DEMAND (VEH/MIN) | CAPACITY (VEH/MIN) | DEMAND/ CAPACITY (RFC) | PEDESTRIAN FLOW (PEDS/MIN) | START QUEUE (VEHS) | END QUEUE (VEHS) | DELAY (VEH.MIN/ TIME SEGMENT) | GEOMETRIC DELAY (VEH.MIN/ TIME SEGMENT) | AVERAGE DELAY PER ARRIVING VEHICLE (MIN) | I |
|---|-------------|---------------------|-----------------------|------------------------------|----------------------------------|--------------------------|------------------------|-------------------------------------|---|--|---|
| I | 17.15-17.30 | | | | | | | | | | I |
| I | B-C | 5.38 | 11.05 | 0.486 | | 0.62 | 0.93 | 13.3 | | 0.17 | I |
| I | B-A | 0.00 | 3.31 | 0.000 | | 0.00 | 0.00 | 0.0 | | 0.00 | I |
| I | C-AB | 7.82 | 10.36 | 0.755 | | 1.49 | 3.22 | 45.3 | | 0.37 | I |
| I | A-B | 0.11 | | | | | | | | | I |
| I | A-C | 5.96 | | | | | | | | | I |

| I | TIME | DEMAND (VEH/MIN) | CAPACITY (VEH/MIN) | DEMAND/ CAPACITY (RFC) | PEDESTRIAN FLOW (PEDS/MIN) | START QUEUE (VEHS) | END QUEUE (VEHS) | DELAY (VEH.MIN/ TIME SEGMENT) | GEOMETRIC DELAY (VEH.MIN/ TIME SEGMENT) | AVERAGE DELAY PER ARRIVING VEHICLE (MIN) | I |
|---|-------------|---------------------|-----------------------|------------------------------|----------------------------------|--------------------------|------------------------|-------------------------------------|---|--|---|
| I | 17.30-17.45 | | | | | | | | | | I |
| I | B-C | 5.38 | 11.05 | 0.486 | | 0.93 | 0.94 | 14.0 | | 0.18 | I |
| I | B-A | 0.00 | 3.28 | 0.000 | | 0.00 | 0.00 | 0.0 | | 0.00 | I |
| I | C-AB | 7.82 | 10.36 | 0.755 | | 3.22 | 3.41 | 52.8 | | 0.40 | I |
| I | A-B | 0.11 | | | | | | | | | I |
| I | A-C | 5.96 | | | | | | | | | I |

| I | TIME | DEMAND (VEH/MIN) | CAPACITY (VEH/MIN) | DEMAND/ CAPACITY (RFC) | PEDESTRIAN FLOW (PEDS/MIN) | START QUEUE (VEHS) | END QUEUE (VEHS) | DELAY (VEH.MIN/ TIME SEGMENT) | GEOMETRIC DELAY (VEH.MIN/ TIME SEGMENT) | AVERAGE DELAY PER ARRIVING VEHICLE (MIN) | I |
|---|-------------|---------------------|-----------------------|------------------------------|----------------------------------|--------------------------|------------------------|-------------------------------------|---|--|---|
| I | 17.45-18.00 | | | | | | | | | | I |
| I | B-C | 4.39 | 11.35 | 0.387 | | 0.94 | 0.64 | 10.0 | | 0.14 | I |
| I | B-A | 0.00 | 4.22 | 0.000 | | 0.00 | 0.00 | 0.0 | | 0.00 | I |
| I | C-AB | 6.38 | 10.64 | 0.600 | | 3.41 | 1.62 | 25.3 | | 0.25 | I |
| I | A-B | 0.09 | | | | | | | | | I |
| I | A-C | 4.87 | | | | | | | | | I |

| I | TIME | DEMAND (VEH/MIN) | CAPACITY (VEH/MIN) | DEMAND/ CAPACITY (RFC) | PEDESTRIAN FLOW (PEDS/MIN) | START QUEUE (VEHS) | END QUEUE (VEHS) | DELAY (VEH.MIN/ TIME SEGMENT) | GEOMETRIC DELAY (VEH.MIN/ TIME SEGMENT) | AVERAGE DELAY PER ARRIVING VEHICLE (MIN) | I |
|---|-------------|---------------------|-----------------------|------------------------------|----------------------------------|--------------------------|------------------------|-------------------------------------|---|--|---|
| I | 18.00-18.15 | | | | | | | | | | I |
| I | B-C | 3.68 | 11.57 | 0.318 | | 0.64 | 0.47 | 7.3 | | 0.13 | I |
| I | B-A | 0.00 | 4.95 | 0.000 | | 0.00 | 0.00 | 0.0 | | 0.00 | I |
| I | C-AB | 5.35 | 10.85 | 0.493 | | 1.62 | 1.00 | 15.3 | | 0.18 | I |
| I | A-B | 0.08 | | | | | | | | | I |
| I | A-C | 4.08 | | | | | | | | | I |

QUEUE FOR STREAM B-C

| TIME SEGMENT ENDING | NO. OF VEHICLES IN QUEUE |
|------------------------|--------------------------------|
| 17.00 | 0.5 |
| 17.15 | 0.6 * |
| 17.30 | 0.9 * |
| 17.45 | 0.9 * |
| 18.00 | 0.6 * |
| 18.15 | 0.5 |

QUEUE FOR STREAM B-A

| TIME SEGMENT ENDING | NO. OF VEHICLES IN QUEUE |
|------------------------|--------------------------------|
| 17.00 | 0.0 |
| 17.15 | 0.0 |
| 17.30 | 0.0 |
| 17.45 | 0.0 |
| 18.00 | 0.0 |
| 18.15 | 0.0 |

QUEUE FOR STREAM C-AB

| TIME SEGMENT ENDING | NO. OF VEHICLES IN QUEUE | |
|---------------------|--------------------------|-----|
| 17.00 | 1.0 | * |
| 17.15 | 1.5 | * |
| 17.30 | 3.2 | *** |
| 17.45 | 3.4 | *** |
| 18.00 | 1.6 | ** |
| 18.15 | 1.0 | * |

QUEUEING DELAY INFORMATION OVER WHOLE PERIOD

| I | STREAM | I | TOTAL DEMAND | I | * QUEUEING * | I | * INCLUSIVE QUEUEING * | I |
|---|--------|----------|--------------|---|--------------|-----------|------------------------|-------|
| I | I | I | I | I | * DELAY * | I | * DELAY * | I |
| I | I | (VEH) | (VEH/H) | I | (MIN) | (MIN/VEH) | I | (MIN) |
| I | I | (VEH) | (VEH/H) | I | (MIN) | (MIN/VEH) | I | (MIN) |
| I | B-C | I 403.3 | I 268.9 | I | 60.2 | I 0.15 | I | 60.2 |
| I | B-A | I 0.0 | I 0.0 | I | 0.0 | I 0.00 | I | 0.0 |
| I | C-AB | I 586.4 | I 390.9 | I | 174.9 | I 0.30 | I | 174.9 |
| I | A-B | I 8.3 | I 5.5 | I | | I | I | |
| I | A-C | I 447.3 | I 298.2 | I | | I | I | |
| I | ALL | I 2243.6 | I 1495.7 | I | 235.1 | I 0.10 | I | 235.1 |

- * DELAY IS THAT OCCURRING ONLY WITHIN THE TIME PERIOD .
- * INCLUSIVE DELAY INCLUDES DELAY SUFFERED BY VEHICLES WHICH ARE STILL QUEUEING AFTER THE END OF THE TIME PERIOD.
- * THESE WILL ONLY BE SIGNIFICANTLY DIFFERENT IF THERE IS A LARGE QUEUE REMAINING AT THE END OF THE TIME PERIOD.

END OF JOB

===== end of file =====

TRL LIMITED

(C) COPYRIGHT 2006

CAPACITIES, QUEUES, AND DELAYS AT 3 OR 4-ARM MAJOR/MINOR PRIORITY JUNCTIONS

PICADY 5.0 ANALYSIS PROGRAM
RELEASE 3.0 (JUNE 2006)

ADAPTED FROM PICADY/3 WHICH IS CROWN COPYRIGHT
BY PERMISSION OF THE CONTROLLER OF HMSO

FOR SALES AND DISTRIBUTION INFORMATION,
PROGRAM ADVICE AND MAINTENANCE CONTACT:
TRL SOFTWARE BUREAU
TEL: CROWTHORNE (01344) 770758, FAX: 770864
EMAIL: SoftwareBureau@trl.co.uk

THE USER OF THIS COMPUTER PROGRAM FOR THE SOLUTION OF AN ENGINEERING PROBLEM IS
IN NO WAY RELIEVED OF HIS RESPONSIBILITY FOR THE CORRECTNESS OF THE SOLUTION

Run with file:-

"J:\120000\120669-00\4 Internal Project Data\4-04 Calculations\4-04-06 Junction Analysis\Picady\
Site 9. Ardley Rd - Unnamed Rd\2013 Base + Gen\PM\Site 9. Ardley Rd - Unnamed Rd 2013 Base + Gen PM.vpi"
(drive-on-the-left) at 13:50:53 on Tuesday, 7 August 2007

RUN INFORMATION

RUN TITLE: Site 9. Ardley Rd - Unnamed Rd 2013 Base + Full Development PM
LOCATION: Oxfordshire
DATE: 07/08/07
CLIENT: North Oxfordshire Consortium
ENUMERATOR: Ian Clarke
JOB NUMBER: 120669
STATUS: TIA
DESCRIPTION:

.MAJOR/MINOR JUNCTION CAPACITY AND DELAY

INPUT DATA

MAJOR ROAD (ARM C) ----- MAJOR ROAD (ARM A)
I
I
I
I
I
I
MINOR ROAD (ARM B)

ARM A IS Ardley Rd (S)
ARM B IS Unnamed Rd (W)
ARM C IS Ardley Rd (N)

STREAM LABELLING CONVENTION

STREAM A-B CONTAINS TRAFFIC GOING FROM ARM A TO ARM B
STREAM B-AC CONTAINS TRAFFIC GOING FROM ARM B TO ARM A AND TO ARM C
ETC.

 GEOMETRIC DATA

| I | DATA ITEM | I | MINOR ROAD B | I |
|---|------------------------------------|---|-----------------|---|
| I | TOTAL MAJOR ROAD CARRIAGEWAY WIDTH | I | (W) 7.80 M. | I |
| I | CENTRAL RESERVE WIDTH | I | (WCR) 0.00 M. | I |
| I | | I | | I |
| I | MAJOR ROAD RIGHT TURN - WIDTH | I | (WC-B) 3.40 M. | I |
| I | - VISIBILITY | I | (VC-B) 100.0 M. | I |
| I | - BLOCKS TRAFFIC | I | YES | I |
| I | | I | | I |
| I | MINOR ROAD - VISIBILITY TO LEFT | I | (VB-C) 100.0 M. | I |
| I | - VISIBILITY TO RIGHT | I | (VB-A) 100.0 M. | I |
| I | - LANE 1 WIDTH | I | (WB-C) - | I |
| I | - LANE 2 WIDTH | I | (WB-A) - | I |
| I | - WIDTH AT 0 M FROM JUNC. | I | 10.00 M. | I |
| I | - WIDTH AT 5 M FROM JUNC. | I | 9.10 M. | I |
| I | - WIDTH AT 10 M FROM JUNC. | I | 4.90 M. | I |
| I | - WIDTH AT 15 M FROM JUNC. | I | 3.00 M. | I |
| I | - WIDTH AT 20 M FROM JUNC. | I | 2.50 M. | I |
| I | - LENGTH OF FLARED SECTION | I | 1 VEHS | I |

 .SLOPES AND INTERCEPT

(NB:Streams may be combined, in which case capacity will be adjusted)

| I | Intercept For Stream B-C | Slope For Opposing Stream A-C | Slope For Opposing Stream A-B | I |
|---|--------------------------|-------------------------------|-------------------------------|---|
| I | 631.87 | 0.23 | 0.09 | I |

| I | Intercept For Stream B-A | Slope For Opposing Stream A-C | Slope For Opposing Stream A-B | Slope For Opposing Stream C-A | Slope For Opposing Stream C-B | I |
|---|--------------------------|-------------------------------|-------------------------------|-------------------------------|-------------------------------|---|
| I | 515.84 | 0.22 | 0.09 | 0.14 | 0.31 | I |

| I | Intercept For Stream C-B | Slope For Opposing Stream A-C | Slope For Opposing Stream A-B | I |
|---|--------------------------|-------------------------------|-------------------------------|---|
| I | 714.40 | 0.26 | 0.26 | I |

NB These values do not allow for any site specific corrections

 TRAFFIC DEMAND DATA

| I | TIME | DEMAND (VEH/MIN) | CAPACITY (VEH/MIN) | DEMAND/ CAPACITY (RFC) | PEDESTRIAN FLOW (PEDS/MIN) | START QUEUE (VEHS) | END QUEUE (VEHS) | DELAY (VEH.MIN/ TIME SEGMENT) | GEOMETRIC DELAY (VEH.MIN/ TIME SEGMENT) | AVERAGE DELAY PER ARRIVING VEHICLE (MIN) | I |
|---|-------------|---------------------|-----------------------|------------------------------|----------------------------------|--------------------------|------------------------|-------------------------------------|---|--|---|
| I | 17.15-17.30 | | | | | | | | | | I |
| I | B-C | 7.23 | 10.34 | 0.699 | | 1.18 | 2.18 | 29.9 | | 0.31 | I |
| I | B-A | 0.02 | 3.14 | 0.006 | | 0.00 | 0.01 | 0.1 | | 0.32 | I |
| I | C-AB | 4.75 | 9.71 | 0.489 | | 0.61 | 0.94 | 14.0 | | 0.20 | I |
| I | A-B | 0.02 | | | | | | | | | I |
| I | A-C | 8.59 | | | | | | | | | I |

| I | TIME | DEMAND (VEH/MIN) | CAPACITY (VEH/MIN) | DEMAND/ CAPACITY (RFC) | PEDESTRIAN FLOW (PEDS/MIN) | START QUEUE (VEHS) | END QUEUE (VEHS) | DELAY (VEH.MIN/ TIME SEGMENT) | GEOMETRIC DELAY (VEH.MIN/ TIME SEGMENT) | AVERAGE DELAY PER ARRIVING VEHICLE (MIN) | I |
|---|-------------|---------------------|-----------------------|------------------------------|----------------------------------|--------------------------|------------------------|-------------------------------------|---|--|---|
| I | 17.30-17.45 | | | | | | | | | | I |
| I | B-C | 7.23 | 10.34 | 0.699 | | 2.18 | 2.25 | 33.4 | | 0.32 | I |
| I | B-A | 0.02 | 3.09 | 0.006 | | 0.01 | 0.01 | 0.1 | | 0.33 | I |
| I | C-AB | 4.75 | 9.71 | 0.489 | | 0.94 | 0.95 | 14.5 | | 0.20 | I |
| I | A-B | 0.02 | | | | | | | | | I |
| I | A-C | 8.59 | | | | | | | | | I |

| I | TIME | DEMAND (VEH/MIN) | CAPACITY (VEH/MIN) | DEMAND/ CAPACITY (RFC) | PEDESTRIAN FLOW (PEDS/MIN) | START QUEUE (VEHS) | END QUEUE (VEHS) | DELAY (VEH.MIN/ TIME SEGMENT) | GEOMETRIC DELAY (VEH.MIN/ TIME SEGMENT) | AVERAGE DELAY PER ARRIVING VEHICLE (MIN) | I |
|---|-------------|---------------------|-----------------------|------------------------------|----------------------------------|--------------------------|------------------------|-------------------------------------|---|--|---|
| I | 17.45-18.00 | | | | | | | | | | I |
| I | B-C | 5.90 | 10.77 | 0.548 | | 2.25 | 1.25 | 20.0 | | 0.21 | I |
| I | B-A | 0.01 | 4.66 | 0.003 | | 0.01 | 0.00 | 0.1 | | 0.22 | I |
| I | C-AB | 3.88 | 10.11 | 0.384 | | 0.95 | 0.63 | 9.6 | | 0.16 | I |
| I | A-B | 0.01 | | | | | | | | | I |
| I | A-C | 7.01 | | | | | | | | | I |

| I | TIME | DEMAND (VEH/MIN) | CAPACITY (VEH/MIN) | DEMAND/ CAPACITY (RFC) | PEDESTRIAN FLOW (PEDS/MIN) | START QUEUE (VEHS) | END QUEUE (VEHS) | DELAY (VEH.MIN/ TIME SEGMENT) | GEOMETRIC DELAY (VEH.MIN/ TIME SEGMENT) | AVERAGE DELAY PER ARRIVING VEHICLE (MIN) | I |
|---|-------------|---------------------|-----------------------|------------------------------|----------------------------------|--------------------------|------------------------|-------------------------------------|---|--|---|
| I | 18.00-18.15 | | | | | | | | | | I |
| I | B-C | 4.94 | 11.08 | 0.446 | | 1.25 | 0.82 | 12.9 | | 0.16 | I |
| I | B-A | 0.01 | 5.69 | 0.002 | | 0.00 | 0.00 | 0.0 | | 0.18 | I |
| I | C-AB | 3.25 | 10.41 | 0.312 | | 0.63 | 0.46 | 6.9 | | 0.14 | I |
| I | A-B | 0.01 | | | | | | | | | I |
| I | A-C | 5.87 | | | | | | | | | I |

QUEUE FOR STREAM B-C

| TIME SEGMENT ENDING | NO. OF VEHICLES IN QUEUE | |
|------------------------|--------------------------------|----|
| 17.00 | 0.8 | * |
| 17.15 | 1.2 | * |
| 17.30 | 2.2 | ** |
| 17.45 | 2.3 | ** |
| 18.00 | 1.2 | * |
| 18.15 | 0.8 | * |

QUEUE FOR STREAM B-A

| TIME SEGMENT ENDING | NO. OF VEHICLES IN QUEUE |
|------------------------|--------------------------------|
| 17.00 | 0.0 |
| 17.15 | 0.0 |
| 17.30 | 0.0 |
| 17.45 | 0.0 |
| 18.00 | 0.0 |
| 18.15 | 0.0 |

QUEUE FOR STREAM C-AB

| TIME SEGMENT ENDING | NO. OF VEHICLES IN QUEUE | |
|---------------------|--------------------------|---|
| 17.00 | 0.4 | |
| 17.15 | 0.6 | * |
| 17.30 | 0.9 | * |
| 17.45 | 1.0 | * |
| 18.00 | 0.6 | * |
| 18.15 | 0.5 | |

QUEUEING DELAY INFORMATION OVER WHOLE PERIOD

| I | STREAM | I | TOTAL DEMAND | I | * QUEUEING * | I | * INCLUSIVE QUEUEING * | I |
|---|--------|----------|--------------|---|--------------|-----------|------------------------|-------|
| I | I | I | I | I | * DELAY * | I | * DELAY * | I |
| I | I | (VEH) | (VEH/H) | I | (MIN) | (MIN/VEH) | I | (MIN) |
| I | I | (VEH) | (VEH/H) | I | (MIN) | (MIN/VEH) | I | (MIN) |
| I | B-C | I 542.3 | I 361.5 | I | 124.1 | I 0.23 | I | 124.2 |
| I | B-A | I 1.4 | I 0.9 | I | 0.3 | I 0.24 | I | 0.3 |
| I | C-AB | I 356.5 | I 237.7 | I | 60.9 | I 0.17 | I | 60.9 |
| I | A-B | I 1.4 | I 0.9 | I | | I | I | |
| I | A-C | I 644.2 | I 429.4 | I | | I | I | |
| I | ALL | I 1971.0 | I 1314.0 | I | 185.3 | I 0.09 | I | 185.3 |

* DELAY IS THAT OCCURRING ONLY WITHIN THE TIME PERIOD .
 * INCLUSIVE DELAY INCLUDES DELAY SUFFERED BY VEHICLES WHICH ARE STILL QUEUEING AFTER THE END OF THE TIME PERIOD.
 * THESE WILL ONLY BE SIGNIFICANTLY DIFFERENT IF THERE IS A LARGE QUEUE REMAINING AT THE END OF THE TIME PERIOD.

END OF JOB

===== end of file =====

TRL LIMITED

(C) COPYRIGHT 2006

CAPACITIES, QUEUES, AND DELAYS AT 3 OR 4-ARM MAJOR/MINOR PRIORITY JUNCTIONS

PICADY 5.0 ANALYSIS PROGRAM
RELEASE 3.0 (JUNE 2006)

ADAPTED FROM PICADY/3 WHICH IS CROWN COPYRIGHT
BY PERMISSION OF THE CONTROLLER OF HMSO

FOR SALES AND DISTRIBUTION INFORMATION,
PROGRAM ADVICE AND MAINTENANCE CONTACT:
TRL SOFTWARE BUREAU
TEL: CROWTHORNE (01344) 770758, FAX: 770864
EMAIL: SoftwareBureau@trl.co.uk

THE USER OF THIS COMPUTER PROGRAM FOR THE SOLUTION OF AN ENGINEERING PROBLEM IS
IN NO WAY RELIEVED OF HIS RESPONSIBILITY FOR THE CORRECTNESS OF THE SOLUTION

Run with file:-

"J:\120000\120669-00\4 Internal Project Data\4-04 Calculations\4-04-06 Junction Analysis\Picady\
Site 9. Ardley Rd - Unnamed Rd\Sensitivity Test\AM\
Site 9. Ardley Rd - Unnamed Rd 2013 Base + Full Development ST AM.vpi"
(drive-on-the-left) at 11:04:56 on Friday, 3 August 2007

RUN INFORMATION

RUN TITLE: Site 9. Ardley Rd - Unnamed Rd 2013 Base + Full Development ST AM
LOCATION: Oxfordshire
DATE: 31/07/07
CLIENT: North Oxfordshire Consortium
ENUMERATOR: Ian Clarke
JOB NUMBER: 120669
STATUS: TIA

DESCRIPTION:

.MAJOR/MINOR JUNCTION CAPACITY AND DELAY

INPUT DATA

MAJOR ROAD (ARM C) ----- MAJOR ROAD (ARM A)
I
I
I
I
I
I
MINOR ROAD (ARM B)

ARM A IS Ardley Rd (S)
ARM B IS Unnamed Rd (W)
ARM C IS Ardley Rd (N)

STREAM LABELLING CONVENTION

STREAM A-B CONTAINS TRAFFIC GOING FROM ARM A TO ARM B
STREAM B-AC CONTAINS TRAFFIC GOING FROM ARM B TO ARM A AND TO ARM C
ETC.

 GEOMETRIC DATA

| I | DATA ITEM | I | MINOR ROAD B | I |
|---|------------------------------------|---|-----------------|---|
| I | TOTAL MAJOR ROAD CARRIAGEWAY WIDTH | I | (W) 7.80 M. | I |
| I | CENTRAL RESERVE WIDTH | I | (WCR) 0.00 M. | I |
| I | | I | | I |
| I | MAJOR ROAD RIGHT TURN - WIDTH | I | (WC-B) 3.40 M. | I |
| I | - VISIBILITY | I | (VC-B) 100.0 M. | I |
| I | - BLOCKS TRAFFIC | I | YES | I |
| I | | I | | I |
| I | MINOR ROAD - VISIBILITY TO LEFT | I | (VB-C) 100.0 M. | I |
| I | - VISIBILITY TO RIGHT | I | (VB-A) 100.0 M. | I |
| I | - LANE 1 WIDTH | I | (WB-C) - | I |
| I | - LANE 2 WIDTH | I | (WB-A) - | I |
| I | - WIDTH AT 0 M FROM JUNC. | I | 10.00 M. | I |
| I | - WIDTH AT 5 M FROM JUNC. | I | 9.10 M. | I |
| I | - WIDTH AT 10 M FROM JUNC. | I | 4.90 M. | I |
| I | - WIDTH AT 15 M FROM JUNC. | I | 3.00 M. | I |
| I | - WIDTH AT 20 M FROM JUNC. | I | 2.50 M. | I |
| I | - LENGTH OF FLARED SECTION | I | 1 VEHS | I |

 .SLOPES AND INTERCEPT

(NB:Streams may be combined, in which case capacity will be adjusted)

| I | Intercept For Stream B-C | Slope For Opposing Stream A-C | Slope For Opposing Stream A-B | I |
|---|--------------------------|-------------------------------|-------------------------------|---|
| I | 631.87 | 0.23 | 0.09 | I |

| I | Intercept For Stream B-A | Slope For Opposing Stream A-C | Slope For Opposing Stream A-B | Slope For Opposing Stream C-A | Slope For Opposing Stream C-B | I |
|---|--------------------------|-------------------------------|-------------------------------|-------------------------------|-------------------------------|---|
| I | 515.84 | 0.22 | 0.09 | 0.14 | 0.31 | I |

| I | Intercept For Stream C-B | Slope For Opposing Stream A-C | Slope For Opposing Stream A-B | I |
|---|--------------------------|-------------------------------|-------------------------------|---|
| I | 714.40 | 0.26 | 0.26 | I |

NB These values do not allow for any site specific corrections

 TRAFFIC DEMAND DATA

| I | TIME | DEMAND (VEH/MIN) | CAPACITY (VEH/MIN) | DEMAND/ CAPACITY (RFC) | PEDESTRIAN FLOW (PEDS/MIN) | START QUEUE (VEHS) | END QUEUE (VEHS) | DELAY (VEH.MIN/ TIME SEGMENT) | GEOMETRIC DELAY (VEH.MIN/ TIME SEGMENT) | AVERAGE DELAY PER ARRIVING VEHICLE (MIN) | I |
|---|-------------|---------------------|-----------------------|------------------------------|----------------------------------|--------------------------|------------------------|-------------------------------------|---|--|---|
| I | 08.15-08.30 | | | | | | | | | | I |
| I | B-C | 7.51 | 11.05 | 0.679 | | 1.14 | 2.01 | 27.8 | | 0.27 | I |
| I | B-A | 0.00 | 2.86 | 0.000 | | 0.00 | 0.00 | 0.0 | | 0.00 | I |
| I | C-AB | 9.21 | 10.36 | 0.889 | | 2.45 | 7.69 | 99.5 | | 0.64 | I |
| I | A-B | 0.11 | | | | | | | | | I |
| I | A-C | 5.96 | | | | | | | | | I |

| I | TIME | DEMAND (VEH/MIN) | CAPACITY (VEH/MIN) | DEMAND/ CAPACITY (RFC) | PEDESTRIAN FLOW (PEDS/MIN) | START QUEUE (VEHS) | END QUEUE (VEHS) | DELAY (VEH.MIN/ TIME SEGMENT) | GEOMETRIC DELAY (VEH.MIN/ TIME SEGMENT) | AVERAGE DELAY PER ARRIVING VEHICLE (MIN) | I |
|---|-------------|---------------------|-----------------------|------------------------------|----------------------------------|--------------------------|------------------------|-------------------------------------|---|--|---|
| I | 08.30-08.45 | | | | | | | | | | I |
| I | B-C | 7.51 | 11.05 | 0.679 | | 2.01 | 2.06 | 30.6 | | 0.28 | I |
| I | B-A | 0.00 | 2.75 | 0.000 | | 0.00 | 0.00 | 0.0 | | 0.00 | I |
| I | C-AB | 9.21 | 10.36 | 0.889 | | 7.69 | 9.22 | 145.0 | | 0.85 | I |
| I | A-B | 0.11 | | | | | | | | | I |
| I | A-C | 5.96 | | | | | | | | | I |

| I | TIME | DEMAND (VEH/MIN) | CAPACITY (VEH/MIN) | DEMAND/ CAPACITY (RFC) | PEDESTRIAN FLOW (PEDS/MIN) | START QUEUE (VEHS) | END QUEUE (VEHS) | DELAY (VEH.MIN/ TIME SEGMENT) | GEOMETRIC DELAY (VEH.MIN/ TIME SEGMENT) | AVERAGE DELAY PER ARRIVING VEHICLE (MIN) | I |
|---|-------------|---------------------|-----------------------|------------------------------|----------------------------------|--------------------------|------------------------|-------------------------------------|---|--|---|
| I | 08.45-09.00 | | | | | | | | | | I |
| I | B-C | 6.13 | 11.35 | 0.540 | | 2.06 | 1.20 | 19.2 | | 0.20 | I |
| I | B-A | 0.00 | 3.75 | 0.000 | | 0.00 | 0.00 | 0.0 | | 0.00 | I |
| I | C-AB | 7.52 | 10.64 | 0.707 | | 9.22 | 2.89 | 56.2 | | 0.42 | I |
| I | A-B | 0.09 | | | | | | | | | I |
| I | A-C | 4.87 | | | | | | | | | I |

| I | TIME | DEMAND (VEH/MIN) | CAPACITY (VEH/MIN) | DEMAND/ CAPACITY (RFC) | PEDESTRIAN FLOW (PEDS/MIN) | START QUEUE (VEHS) | END QUEUE (VEHS) | DELAY (VEH.MIN/ TIME SEGMENT) | GEOMETRIC DELAY (VEH.MIN/ TIME SEGMENT) | AVERAGE DELAY PER ARRIVING VEHICLE (MIN) | I |
|---|-------------|---------------------|-----------------------|------------------------------|----------------------------------|--------------------------|------------------------|-------------------------------------|---|--|---|
| I | 09.00-09.15 | | | | | | | | | | I |
| I | B-C | 5.13 | 11.57 | 0.444 | | 1.20 | 0.81 | 12.7 | | 0.16 | I |
| I | B-A | 0.00 | 4.63 | 0.000 | | 0.00 | 0.00 | 0.0 | | 0.00 | I |
| I | C-AB | 6.30 | 10.85 | 0.581 | | 2.89 | 1.47 | 22.8 | | 0.23 | I |
| I | A-B | 0.08 | | | | | | | | | I |
| I | A-C | 4.08 | | | | | | | | | I |

QUEUE FOR STREAM B-C

| TIME SEGMENT ENDING | NO. OF VEHICLES IN QUEUE |
|------------------------|--------------------------------|
| 08.00 | 0.8 * |
| 08.15 | 1.1 * |
| 08.30 | 2.0 ** |
| 08.45 | 2.1 ** |
| 09.00 | 1.2 * |
| 09.15 | 0.8 * |

QUEUE FOR STREAM B-A

| TIME SEGMENT ENDING | NO. OF VEHICLES IN QUEUE |
|------------------------|--------------------------------|
| 08.00 | 0.0 |
| 08.15 | 0.0 |
| 08.30 | 0.0 |
| 08.45 | 0.0 |
| 09.00 | 0.0 |
| 09.15 | 0.0 |

QUEUE FOR STREAM C-AB

| TIME SEGMENT ENDING | NO. OF VEHICLES IN QUEUE | |
|---------------------|--------------------------|-------|
| 08.00 | 1.4 | * |
| 08.15 | 2.4 | ** |
| 08.30 | 7.7 | ***** |
| 08.45 | 9.2 | ***** |
| 09.00 | 2.9 | *** |
| 09.15 | 1.5 | * |

QUEUEING DELAY INFORMATION OVER WHOLE PERIOD

| I | STREAM | I | TOTAL DEMAND | I | * QUEUEING * | I | * INCLUSIVE QUEUEING * | I | | |
|---|--------|---|--------------|---------|--------------|-----------|------------------------|-----------|------|---|
| I | I | I | I | I | * DELAY * | I | * DELAY * | I | | |
| I | I | I | (VEH) | (VEH/H) | (MIN) | (MIN/VEH) | (MIN) | (MIN/VEH) | | |
| I | B-C | I | 563.0 | I | 375.3 | I | 117.7 | I | 0.21 | I |
| I | B-A | I | 0.0 | I | 0.0 | I | 0.0 | I | 0.00 | I |
| I | C-AB | I | 691.0 | I | 460.6 | I | 378.9 | I | 0.55 | I |
| I | A-B | I | 8.3 | I | 5.5 | I | | I | | I |
| I | A-C | I | 447.3 | I | 298.2 | I | | I | | I |
| I | ALL | I | 2507.8 | I | 1671.9 | I | 496.5 | I | 0.20 | I |

* DELAY IS THAT OCCURRING ONLY WITHIN THE TIME PERIOD .
 * INCLUSIVE DELAY INCLUDES DELAY SUFFERED BY VEHICLES WHICH ARE STILL QUEUEING AFTER THE END OF THE TIME PERIOD.
 * THESE WILL ONLY BE SIGNIFICANTLY DIFFERENT IF THERE IS A LARGE QUEUE REMAINING AT THE END OF THE TIME PERIOD.

END OF JOB

===== end of file =====

TRL LIMITED

(C) COPYRIGHT 2006

CAPACITIES, QUEUES, AND DELAYS AT 3 OR 4-ARM MAJOR/MINOR PRIORITY JUNCTIONS

PICADY 5.0 ANALYSIS PROGRAM
RELEASE 3.0 (JUNE 2006)

ADAPTED FROM PICADY/3 WHICH IS CROWN COPYRIGHT
BY PERMISSION OF THE CONTROLLER OF HMSO

FOR SALES AND DISTRIBUTION INFORMATION,
PROGRAM ADVICE AND MAINTENANCE CONTACT:
TRL SOFTWARE BUREAU
TEL: CROWTHORNE (01344) 770758, FAX: 770864
EMAIL: SoftwareBureau@trl.co.uk

THE USER OF THIS COMPUTER PROGRAM FOR THE SOLUTION OF AN ENGINEERING PROBLEM IS
IN NO WAY RELIEVED OF HIS RESPONSIBILITY FOR THE CORRECTNESS OF THE SOLUTION

Run with file:-

"J:\120000\120669-00\4 Internal Project Data\4-04 Calculations\4-04-06 Junction Analysis\Picady\
Site 9. Ardley Rd - Unnamed Rd\Sensitivity Test\PM\
Site 9. Ardley Rd - Unnamed Rd 2013 Base + Full Development ST PM.vpi"
(drive-on-the-left) at 11:05:45 on Friday, 3 August 2007

RUN INFORMATION

RUN TITLE: Site 9. Ardley Rd - Unnamed Rd 2013 Base + Full Development ST PM

LOCATION: Oxfordshire

DATE: 31/07/07

CLIENT: North Oxfordshire Consortium

ENUMERATOR: Ian Clarke

JOB NUMBER: 120669

STATUS: TIA

DESCRIPTION:

.MAJOR/MINOR JUNCTION CAPACITY AND DELAY

INPUT DATA

MAJOR ROAD (ARM C) ----- MAJOR ROAD (ARM A)

I
I
I
I
I
I

MINOR ROAD (ARM B)

ARM A IS Ardley Rd (S)
ARM B IS Unnamed Rd (W)
ARM C IS Ardley Rd (N)

STREAM LABELLING CONVENTION

STREAM A-B CONTAINS TRAFFIC GOING FROM ARM A TO ARM B

STREAM B-AC CONTAINS TRAFFIC GOING FROM ARM B TO ARM A AND TO ARM C

ETC.

 GEOMETRIC DATA

| I | DATA ITEM | I | MINOR ROAD B | I |
|---|------------------------------------|---|-----------------|---|
| I | TOTAL MAJOR ROAD CARRIAGEWAY WIDTH | I | (W) 7.80 M. | I |
| I | CENTRAL RESERVE WIDTH | I | (WCR) 0.00 M. | I |
| I | | I | | I |
| I | MAJOR ROAD RIGHT TURN - WIDTH | I | (WC-B) 3.40 M. | I |
| I | - VISIBILITY | I | (VC-B) 100.0 M. | I |
| I | - BLOCKS TRAFFIC | I | YES | I |
| I | | I | | I |
| I | MINOR ROAD - VISIBILITY TO LEFT | I | (VB-C) 100.0 M. | I |
| I | - VISIBILITY TO RIGHT | I | (VB-A) 100.0 M. | I |
| I | - LANE 1 WIDTH | I | (WB-C) - | I |
| I | - LANE 2 WIDTH | I | (WB-A) - | I |
| I | - WIDTH AT 0 M FROM JUNC. | I | 10.00 M. | I |
| I | - WIDTH AT 5 M FROM JUNC. | I | 9.10 M. | I |
| I | - WIDTH AT 10 M FROM JUNC. | I | 4.90 M. | I |
| I | - WIDTH AT 15 M FROM JUNC. | I | 3.00 M. | I |
| I | - WIDTH AT 20 M FROM JUNC. | I | 2.50 M. | I |
| I | - LENGTH OF FLARED SECTION | I | 1 VEHS | I |

 .SLOPES AND INTERCEPT

(NB:Streams may be combined, in which case capacity will be adjusted)

| I | Intercept For Stream B-C | Slope For Stream A-C | Slope For Opposing Stream A-B | I |
|---|--------------------------|----------------------|-------------------------------|---|
| I | 631.87 | 0.23 | 0.09 | I |

| I | Intercept For Stream B-A | Slope For Stream A-C | Slope For Opposing Stream A-B | Slope For Opposing Stream C-A | Slope For Opposing Stream C-B | I |
|---|--------------------------|----------------------|-------------------------------|-------------------------------|-------------------------------|---|
| I | 515.84 | 0.22 | 0.09 | 0.14 | 0.31 | I |

| I | Intercept For Stream C-B | Slope For Stream A-C | Slope For Opposing Stream A-B | I |
|---|--------------------------|----------------------|-------------------------------|---|
| I | 714.40 | 0.26 | 0.26 | I |

NB These values do not allow for any site specific corrections

 TRAFFIC DEMAND DATA

| I | TIME | DEMAND (VEH/MIN) | CAPACITY (VEH/MIN) | DEMAND/ CAPACITY (RFC) | PEDESTRIAN FLOW (PEDS/MIN) | START QUEUE (VEHS) | END QUEUE (VEHS) | DELAY (VEH.MIN/ TIME SEGMENT) | GEOMETRIC DELAY (VEH.MIN/ TIME SEGMENT) | AVERAGE DELAY PER ARRIVING VEHICLE (MIN) | I |
|---|-------------|---------------------|-----------------------|------------------------------|----------------------------------|--------------------------|------------------------|-------------------------------------|---|--|---|
| I | 17.15-17.30 | | | | | | | | | | I |
| I | B-C | 8.88 | 10.34 | 0.859 | | 1.96 | 4.87 | 60.8 | | 0.55 | I |
| I | B-A | 0.02 | 1.43 | 0.013 | | 0.00 | 0.01 | 0.2 | | 0.71 | I |
| I | C-AB | 6.57 | 9.71 | 0.676 | | 1.11 | 2.06 | 30.0 | | 0.31 | I |
| I | A-B | 0.02 | | | | | | | | | I |
| I | A-C | 8.59 | | | | | | | | | I |

| I | TIME | DEMAND (VEH/MIN) | CAPACITY (VEH/MIN) | DEMAND/ CAPACITY (RFC) | PEDESTRIAN FLOW (PEDS/MIN) | START QUEUE (VEHS) | END QUEUE (VEHS) | DELAY (VEH.MIN/ TIME SEGMENT) | GEOMETRIC DELAY (VEH.MIN/ TIME SEGMENT) | AVERAGE DELAY PER ARRIVING VEHICLE (MIN) | I |
|---|-------------|---------------------|-----------------------|------------------------------|----------------------------------|--------------------------|------------------------|-------------------------------------|---|--|---|
| I | 17.30-17.45 | | | | | | | | | | I |
| I | B-C | 8.88 | 10.34 | 0.859 | | 4.87 | 5.35 | 77.3 | | 0.64 | I |
| I | B-A | 0.02 | 1.24 | 0.015 | | 0.01 | 0.01 | 0.2 | | 0.82 | I |
| I | C-AB | 6.57 | 9.71 | 0.676 | | 2.06 | 2.13 | 32.7 | | 0.32 | I |
| I | A-B | 0.02 | | | | | | | | | I |
| I | A-C | 8.59 | | | | | | | | | I |

| I | TIME | DEMAND (VEH/MIN) | CAPACITY (VEH/MIN) | DEMAND/ CAPACITY (RFC) | PEDESTRIAN FLOW (PEDS/MIN) | START QUEUE (VEHS) | END QUEUE (VEHS) | DELAY (VEH.MIN/ TIME SEGMENT) | GEOMETRIC DELAY (VEH.MIN/ TIME SEGMENT) | AVERAGE DELAY PER ARRIVING VEHICLE (MIN) | I |
|---|-------------|---------------------|-----------------------|------------------------------|----------------------------------|--------------------------|------------------------|-------------------------------------|---|--|---|
| I | 17.45-18.00 | | | | | | | | | | I |
| I | B-C | 7.25 | 10.77 | 0.673 | | 5.35 | 2.18 | 37.3 | | 0.32 | I |
| I | B-A | 0.01 | 3.33 | 0.005 | | 0.01 | 0.00 | 0.1 | | 0.30 | I |
| I | C-AB | 5.36 | 10.11 | 0.530 | | 2.13 | 1.17 | 18.0 | | 0.22 | I |
| I | A-B | 0.01 | | | | | | | | | I |
| I | A-C | 7.01 | | | | | | | | | I |

| I | TIME | DEMAND (VEH/MIN) | CAPACITY (VEH/MIN) | DEMAND/ CAPACITY (RFC) | PEDESTRIAN FLOW (PEDS/MIN) | START QUEUE (VEHS) | END QUEUE (VEHS) | DELAY (VEH.MIN/ TIME SEGMENT) | GEOMETRIC DELAY (VEH.MIN/ TIME SEGMENT) | AVERAGE DELAY PER ARRIVING VEHICLE (MIN) | I |
|---|-------------|---------------------|-----------------------|------------------------------|----------------------------------|--------------------------|------------------------|-------------------------------------|---|--|---|
| I | 18.00-18.15 | | | | | | | | | | I |
| I | B-C | 6.07 | 11.08 | 0.548 | | 2.18 | 1.25 | 19.9 | | 0.20 | I |
| I | B-A | 0.01 | 4.81 | 0.003 | | 0.00 | 0.00 | 0.0 | | 0.21 | I |
| I | C-AB | 4.49 | 10.41 | 0.432 | | 1.17 | 0.78 | 11.8 | | 0.17 | I |
| I | A-B | 0.01 | | | | | | | | | I |
| I | A-C | 5.87 | | | | | | | | | I |

QUEUE FOR STREAM B-C

| TIME SEGMENT ENDING | NO. OF VEHICLES IN QUEUE | |
|------------------------|--------------------------------|-------|
| 17.00 | 1.2 | * |
| 17.15 | 2.0 | ** |
| 17.30 | 4.9 | ***** |
| 17.45 | 5.4 | ***** |
| 18.00 | 2.2 | ** |
| 18.15 | 1.2 | * |

QUEUE FOR STREAM B-A

| TIME SEGMENT ENDING | NO. OF VEHICLES IN QUEUE |
|------------------------|--------------------------------|
| 17.00 | 0.0 |
| 17.15 | 0.0 |
| 17.30 | 0.0 |
| 17.45 | 0.0 |
| 18.00 | 0.0 |
| 18.15 | 0.0 |

 QUEUE FOR STREAM C-AB

| TIME SEGMENT ENDING | NO. OF VEHICLES IN QUEUE | |
|------------------------|--------------------------------|----|
| 17.00 | 0.7 | * |
| 17.15 | 1.1 | * |
| 17.30 | 2.1 | ** |
| 17.45 | 2.1 | ** |
| 18.00 | 1.2 | * |
| 18.15 | 0.8 | * |

 QUEUEING DELAY INFORMATION OVER WHOLE PERIOD

| I | STREAM | I | TOTAL DEMAND | I | * QUEUEING * | I | * INCLUSIVE QUEUEING * | I | | | | | | |
|---|--------|---|--------------|---------|--------------|-----------|------------------------|-----------|------|---|-------|---|------|---|
| I | I | I | I | I | * DELAY * | I | * DELAY * | I | | | | | | |
| I | I | I | (VEH) | (VEH/H) | (MIN) | (MIN/VEH) | (MIN) | (MIN/VEH) | | | | | | |
| I | B-C | I | 666.2 | I | 444.1 | I | 238.9 | I | 0.36 | I | 239.0 | I | 0.36 | I |
| I | B-A | I | 1.4 | I | 0.9 | I | 0.6 | I | 0.43 | I | 0.6 | I | 0.43 | I |
| I | C-AB | I | 492.8 | I | 328.5 | I | 120.0 | I | 0.24 | I | 120.1 | I | 0.24 | I |
| I | A-B | I | 1.4 | I | 0.9 | I | | I | | I | | I | | I |
| I | A-C | I | 644.2 | I | 429.4 | I | | I | | I | | I | | I |
| I | ALL | I | 2231.2 | I | 1487.5 | I | 359.6 | I | 0.16 | I | 359.7 | I | 0.16 | I |

* DELAY IS THAT OCCURRING ONLY WITHIN THE TIME PERIOD .
 * INCLUSIVE DELAY INCLUDES DELAY SUFFERED BY VEHICLES WHICH ARE STILL QUEUEING AFTER THE END OF THE TIME PERIOD.
 * THESE WILL ONLY BE SIGNIFICANTLY DIFFERENT IF THERE IS A LARGE QUEUE REMAINING AT THE END OF THE TIME PERIOD.

END OF JOB

===== end of file =====

TRL LIMITED

(C) COPYRIGHT 2006

CAPACITIES, QUEUES, AND DELAYS AT 3 OR 4-ARM MAJOR/MINOR PRIORITY JUNCTIONS

PICADY 5.0 ANALYSIS PROGRAM
RELEASE 3.0 (JUNE 2006)

ADAPTED FROM PICADY/3 WHICH IS CROWN COPYRIGHT
BY PERMISSION OF THE CONTROLLER OF HMSO

FOR SALES AND DISTRIBUTION INFORMATION,
PROGRAM ADVICE AND MAINTENANCE CONTACT:
TRL SOFTWARE BUREAU
TEL: CROWTHORNE (01344) 770758, FAX: 770864
EMAIL: SoftwareBureau@trl.co.uk

THE USER OF THIS COMPUTER PROGRAM FOR THE SOLUTION OF AN ENGINEERING PROBLEM IS
IN NO WAY RELIEVED OF HIS RESPONSIBILITY FOR THE CORRECTNESS OF THE SOLUTION

Run with file:-

"J:\120000\120669-00\4 Internal Project Data\4-04 Calculations\4-04-06 Junction Analysis\Picady\
Site 10. Camp Rd - B430 to Ardley\2006 Base\AM\Site 10. Camp Rd - Unnamed Rd 2006 Base AM.vpi"
(drive-on-the-left) at 11:04:22 on Wednesday, 11 July 2007

RUN INFORMATION

RUN TITLE: Site 10. Camp Road - Unnamed Rd towards B430 2006 Base AM
LOCATION: Oxfordshire
DATE: 09/11/06
CLIENT: North Oxfordshire Consortium
ENUMERATOR: Chris.Morris [MCCPC062011]
JOB NUMBER: 120669
STATUS: TIA
DESCRIPTION:

.MAJOR/MINOR JUNCTION CAPACITY AND DELAY

INPUT DATA

MAJOR ROAD (ARM C) ----- MAJOR ROAD (ARM A)
I
I
I
I
I
I
MINOR ROAD (ARM B)

ARM A IS Camp Rd (W)
ARM B IS Unnamed Rd (E) towards B430
ARM C IS Unnamed Rd (S) towards Middleton Stoney

STREAM LABELLING CONVENTION

STREAM A-B CONTAINS TRAFFIC GOING FROM ARM A TO ARM B
STREAM B-AC CONTAINS TRAFFIC GOING FROM ARM B TO ARM A AND TO ARM C
ETC.

 GEOMETRIC DATA

| I | DATA ITEM | I | MINOR ROAD B | I |
|---|------------------------------------|---|-----------------|---|
| I | TOTAL MAJOR ROAD CARRIAGEWAY WIDTH | I | (W) 6.10 M. | I |
| I | CENTRAL RESERVE WIDTH | I | (WCR) 0.00 M. | I |
| I | | I | | I |
| I | MAJOR ROAD RIGHT TURN - WIDTH | I | (WC-B) 2.20 M. | I |
| I | - VISIBILITY | I | (VC-B) 130.0 M. | I |
| I | - BLOCKS TRAFFIC | I | YES | I |
| I | | I | | I |
| I | MINOR ROAD - VISIBILITY TO LEFT | I | (VB-C) 120.0 M. | I |
| I | - VISIBILITY TO RIGHT | I | (VB-A) 145.0 M. | I |
| I | - LANE 1 WIDTH | I | (WB-C) - | I |
| I | - LANE 2 WIDTH | I | (WB-A) - | I |
| I | - WIDTH AT 0 M FROM JUNC. | I | 10.00 M. | I |
| I | - WIDTH AT 5 M FROM JUNC. | I | 6.00 M. | I |
| I | - WIDTH AT 10 M FROM JUNC. | I | 4.30 M. | I |
| I | - WIDTH AT 15 M FROM JUNC. | I | 3.40 M. | I |
| I | - WIDTH AT 20 M FROM JUNC. | I | 3.40 M. | I |
| I | - LENGTH OF FLARED SECTION | I | 1 VEHS | I |

 .SLOPES AND INTERCEPT

(NB:Streams may be combined, in which case capacity will be adjusted)

| I | Intercept For Stream B-C | Slope For Opposing Stream A-C | Slope For Opposing Stream A-B | I |
|---|--------------------------|-------------------------------|-------------------------------|---|
| I | 657.93 | 0.25 | 0.10 | I |

| I | Intercept For Stream B-A | Slope For Opposing Stream A-C | Slope For Opposing Stream A-B | Slope For Opposing Stream C-A | Slope For Opposing Stream C-B | I |
|---|--------------------------|-------------------------------|-------------------------------|-------------------------------|-------------------------------|---|
| I | 543.76 | 0.25 | 0.10 | 0.16 | 0.36 | I |

| I | Intercept For Stream C-B | Slope For Opposing Stream A-C | Slope For Opposing Stream A-B | I |
|---|--------------------------|-------------------------------|-------------------------------|---|
| I | 649.25 | 0.25 | 0.25 | I |

NB These values do not allow for any site specific corrections

 TRAFFIC DEMAND DATA

| I | TIME | DEMAND (VEH/MIN) | CAPACITY (VEH/MIN) | DEMAND/ CAPACITY (RFC) | PEDESTRIAN FLOW (PEDS/MIN) | START QUEUE (VEHS) | END QUEUE (VEHS) | DELAY (VEH.MIN/ TIME SEGMENT) | GEOMETRIC DELAY (VEH.MIN/ TIME SEGMENT) | AVERAGE DELAY PER ARRIVING VEHICLE (MIN) | I |
|---|-------------|---------------------|-----------------------|------------------------------|----------------------------------|--------------------------|------------------------|-------------------------------------|---|--|---|
| I | 08.15-08.30 | | | | | | | | | | I |
| I | B-C | 0.33 | 12.35 | 0.027 | | 0.02 | 0.03 | 0.4 | | 0.08 | I |
| I | B-A | 0.53 | 10.86 | 0.049 | | 0.04 | 0.05 | 0.8 | | 0.10 | I |
| I | C-AB | 0.15 | 10.60 | 0.014 | | 0.01 | 0.01 | 0.2 | | 0.10 | I |
| I | A-B | 0.42 | | | | | | | | | I |
| I | A-C | 0.48 | | | | | | | | | I |

| I | TIME | DEMAND (VEH/MIN) | CAPACITY (VEH/MIN) | DEMAND/ CAPACITY (RFC) | PEDESTRIAN FLOW (PEDS/MIN) | START QUEUE (VEHS) | END QUEUE (VEHS) | DELAY (VEH.MIN/ TIME SEGMENT) | GEOMETRIC DELAY (VEH.MIN/ TIME SEGMENT) | AVERAGE DELAY PER ARRIVING VEHICLE (MIN) | I |
|---|-------------|---------------------|-----------------------|------------------------------|----------------------------------|--------------------------|------------------------|-------------------------------------|---|--|---|
| I | 08.30-08.45 | | | | | | | | | | I |
| I | B-C | 0.33 | 12.35 | 0.027 | | 0.03 | 0.03 | 0.4 | | 0.08 | I |
| I | B-A | 0.53 | 10.86 | 0.049 | | 0.05 | 0.05 | 0.8 | | 0.10 | I |
| I | C-AB | 0.15 | 10.60 | 0.014 | | 0.01 | 0.01 | 0.2 | | 0.10 | I |
| I | A-B | 0.42 | | | | | | | | | I |
| I | A-C | 0.48 | | | | | | | | | I |

| I | TIME | DEMAND (VEH/MIN) | CAPACITY (VEH/MIN) | DEMAND/ CAPACITY (RFC) | PEDESTRIAN FLOW (PEDS/MIN) | START QUEUE (VEHS) | END QUEUE (VEHS) | DELAY (VEH.MIN/ TIME SEGMENT) | GEOMETRIC DELAY (VEH.MIN/ TIME SEGMENT) | AVERAGE DELAY PER ARRIVING VEHICLE (MIN) | I |
|---|-------------|---------------------|-----------------------|------------------------------|----------------------------------|--------------------------|------------------------|-------------------------------------|---|--|---|
| I | 08.45-09.00 | | | | | | | | | | I |
| I | B-C | 0.27 | 12.41 | 0.022 | | 0.03 | 0.02 | 0.3 | | 0.08 | I |
| I | B-A | 0.43 | 10.92 | 0.040 | | 0.05 | 0.04 | 0.6 | | 0.10 | I |
| I | C-AB | 0.12 | 10.64 | 0.011 | | 0.01 | 0.01 | 0.2 | | 0.10 | I |
| I | A-B | 0.34 | | | | | | | | | I |
| I | A-C | 0.39 | | | | | | | | | I |

| I | TIME | DEMAND (VEH/MIN) | CAPACITY (VEH/MIN) | DEMAND/ CAPACITY (RFC) | PEDESTRIAN FLOW (PEDS/MIN) | START QUEUE (VEHS) | END QUEUE (VEHS) | DELAY (VEH.MIN/ TIME SEGMENT) | GEOMETRIC DELAY (VEH.MIN/ TIME SEGMENT) | AVERAGE DELAY PER ARRIVING VEHICLE (MIN) | I |
|---|-------------|---------------------|-----------------------|------------------------------|----------------------------------|--------------------------|------------------------|-------------------------------------|---|--|---|
| I | 09.00-09.15 | | | | | | | | | | I |
| I | B-C | 0.23 | 12.46 | 0.018 | | 0.02 | 0.02 | 0.3 | | 0.08 | I |
| I | B-A | 0.36 | 10.96 | 0.033 | | 0.04 | 0.03 | 0.5 | | 0.09 | I |
| I | C-AB | 0.10 | 10.67 | 0.009 | | 0.01 | 0.01 | 0.1 | | 0.09 | I |
| I | A-B | 0.29 | | | | | | | | | I |
| I | A-C | 0.33 | | | | | | | | | I |

QUEUE FOR STREAM B-C

| TIME SEGMENT ENDING | NO. OF VEHICLES IN QUEUE |
|------------------------|--------------------------------|
| 08.00 | 0.0 |
| 08.15 | 0.0 |
| 08.30 | 0.0 |
| 08.45 | 0.0 |
| 09.00 | 0.0 |
| 09.15 | 0.0 |

QUEUE FOR STREAM B-A

| TIME SEGMENT ENDING | NO. OF VEHICLES IN QUEUE |
|------------------------|--------------------------------|
| 08.00 | 0.0 |
| 08.15 | 0.0 |
| 08.30 | 0.1 |
| 08.45 | 0.1 |
| 09.00 | 0.0 |
| 09.15 | 0.0 |

QUEUE FOR STREAM C-AB

| TIME SEGMENT ENDING | NO. OF VEHICLES IN QUEUE |
|---------------------|--------------------------|
| 08.00 | 0.0 |
| 08.15 | 0.0 |
| 08.30 | 0.0 |
| 08.45 | 0.0 |
| 09.00 | 0.0 |
| 09.15 | 0.0 |

QUEUEING DELAY INFORMATION OVER WHOLE PERIOD

| I | STREAM | I | TOTAL DEMAND | I | * QUEUEING * * DELAY * | I | * INCLUSIVE QUEUEING * * DELAY * | I | | |
|---|--------|-------|--------------|---|---------------------------|-----------|-------------------------------------|-------|-----------|---|
| I | I | (VEH) | (VEH/H) | I | (MIN) | (MIN/VEH) | I | (MIN) | (MIN/VEH) | I |
| I | B-C | I | 24.8 | I | 16.5 | I | 2.0 | I | 0.08 | I |
| I | B-A | I | 39.9 | I | 26.6 | I | 3.8 | I | 0.10 | I |
| I | C-AB | I | 11.0 | I | 7.3 | I | 1.0 | I | 0.10 | I |
| I | A-B | I | 31.7 | I | 21.1 | I | | I | | I |
| I | A-C | I | 35.8 | I | 23.9 | I | | I | | I |
| I | ALL | I | 167.9 | I | 111.9 | I | 6.9 | I | 0.04 | I |

* DELAY IS THAT OCCURRING ONLY WITHIN THE TIME PERIOD .
 * INCLUSIVE DELAY INCLUDES DELAY SUFFERED BY VEHICLES WHICH ARE STILL QUEUEING AFTER THE END OF THE TIME PERIOD.
 * THESE WILL ONLY BE SIGNIFICANTLY DIFFERENT IF THERE IS A LARGE QUEUE REMAINING AT THE END OF THE TIME PERIOD.

END OF JOB

===== end of file =====

TRL LIMITED

(C) COPYRIGHT 2006

CAPACITIES, QUEUES, AND DELAYS AT 3 OR 4-ARM MAJOR/MINOR PRIORITY JUNCTIONS

PICADY 5.0 ANALYSIS PROGRAM
RELEASE 3.0 (JUNE 2006)

ADAPTED FROM PICADY/3 WHICH IS CROWN COPYRIGHT
BY PERMISSION OF THE CONTROLLER OF HMSO

FOR SALES AND DISTRIBUTION INFORMATION,
PROGRAM ADVICE AND MAINTENANCE CONTACT:
TRL SOFTWARE BUREAU
TEL: CROWTHORNE (01344) 770758, FAX: 770864
EMAIL: SoftwareBureau@trl.co.uk

THE USER OF THIS COMPUTER PROGRAM FOR THE SOLUTION OF AN ENGINEERING PROBLEM IS
IN NO WAY RELIEVED OF HIS RESPONSIBILITY FOR THE CORRECTNESS OF THE SOLUTION

Run with file:-

"J:\120000\120669-00\4 Internal Project Data\4-04 Calculations\4-04-06 Junction Analysis\Picady\
Site 10. Camp Rd - B430 to Ardley\2006 Base\PM\Site 10. Camp Rd - Unnamed Rd 2006 Base PM.vpi"
(drive-on-the-left) at 11:15:02 on Wednesday, 11 July 2007

RUN INFORMATION

RUN TITLE: Site 10. Camp Road - Unnamed Rd towards B430 2006 Base PM
LOCATION: Oxfordshire
DATE: 09/11/06
CLIENT: North Oxfordshire Consortium
ENUMERATOR: Chris.Morris [MCCPC062011]
JOB NUMBER: 120669
STATUS: TIA
DESCRIPTION:

.MAJOR/MINOR JUNCTION CAPACITY AND DELAY

INPUT DATA

MAJOR ROAD (ARM C) ----- MAJOR ROAD (ARM A)
I
I
I
I
I
I
MINOR ROAD (ARM B)

ARM A IS Camp Rd (W)
ARM B IS Unnamed Rd (E) towards B430
ARM C IS Unnamed Rd (S) towards Middleton Stoney

STREAM LABELLING CONVENTION

STREAM A-B CONTAINS TRAFFIC GOING FROM ARM A TO ARM B
STREAM B-AC CONTAINS TRAFFIC GOING FROM ARM B TO ARM A AND TO ARM C
ETC.

 GEOMETRIC DATA

| I | DATA ITEM | I | MINOR ROAD B | I |
|---|------------------------------------|---|-----------------|---|
| I | TOTAL MAJOR ROAD CARRIAGEWAY WIDTH | I | (W) 6.10 M. | I |
| I | CENTRAL RESERVE WIDTH | I | (WCR) 0.00 M. | I |
| I | | I | | I |
| I | MAJOR ROAD RIGHT TURN - WIDTH | I | (WC-B) 2.20 M. | I |
| I | - VISIBILITY | I | (VC-B) 130.0 M. | I |
| I | - BLOCKS TRAFFIC | I | YES | I |
| I | | I | | I |
| I | MINOR ROAD - VISIBILITY TO LEFT | I | (VB-C) 120.0 M. | I |
| I | - VISIBILITY TO RIGHT | I | (VB-A) 145.0 M. | I |
| I | - LANE 1 WIDTH | I | (WB-C) - | I |
| I | - LANE 2 WIDTH | I | (WB-A) - | I |
| I | - WIDTH AT 0 M FROM JUNC. | I | 10.00 M. | I |
| I | - WIDTH AT 5 M FROM JUNC. | I | 6.00 M. | I |
| I | - WIDTH AT 10 M FROM JUNC. | I | 4.30 M. | I |
| I | - WIDTH AT 15 M FROM JUNC. | I | 3.40 M. | I |
| I | - WIDTH AT 20 M FROM JUNC. | I | 3.40 M. | I |
| I | - LENGTH OF FLARED SECTION | I | 1 VEHS | I |

 .SLOPES AND INTERCEPT

(NB:Streams may be combined, in which case capacity will be adjusted)

| I | Intercept For Stream B-C | Slope For Opposing Stream A-C | Slope For Opposing Stream A-B | I |
|---|--------------------------|-------------------------------|-------------------------------|---|
| I | 657.93 | 0.25 | 0.10 | I |

| I | Intercept For Stream B-A | Slope For Opposing Stream A-C | Slope For Opposing Stream A-B | Slope For Opposing Stream C-A | Slope For Opposing Stream C-B | I |
|---|--------------------------|-------------------------------|-------------------------------|-------------------------------|-------------------------------|---|
| I | 543.76 | 0.25 | 0.10 | 0.16 | 0.36 | I |

| I | Intercept For Stream C-B | Slope For Opposing Stream A-C | Slope For Opposing Stream A-B | I |
|---|--------------------------|-------------------------------|-------------------------------|---|
| I | 649.25 | 0.25 | 0.25 | I |

NB These values do not allow for any site specific corrections

 TRAFFIC DEMAND DATA

| I | TIME | DEMAND (VEH/MIN) | CAPACITY (VEH/MIN) | DEMAND/ CAPACITY (RFC) | PEDESTRIAN FLOW (PEDS/MIN) | START QUEUE (VEHS) | END QUEUE (VEHS) | DELAY (VEH.MIN/ TIME SEGMENT) | GEOMETRIC DELAY (VEH.MIN/ TIME SEGMENT) | AVERAGE DELAY PER ARRIVING VEHICLE (MIN) | I |
|---|-------------|---------------------|-----------------------|------------------------------|----------------------------------|--------------------------|------------------------|-------------------------------------|---|--|---|
| I | 17.15-17.30 | | | | | | | | | | I |
| I | B-C | 0.06 | 11.67 | 0.005 | | 0.00 | 0.00 | 0.1 | | 0.09 | I |
| I | B-A | 0.28 | 10.66 | 0.026 | | 0.02 | 0.03 | 0.4 | | 0.10 | I |
| I | C-AB | 0.31 | 10.59 | 0.029 | | 0.02 | 0.03 | 0.5 | | 0.10 | I |
| I | A-B | 0.48 | | | | | | | | | I |
| I | A-C | 0.46 | | | | | | | | | I |

| I | TIME | DEMAND (VEH/MIN) | CAPACITY (VEH/MIN) | DEMAND/ CAPACITY (RFC) | PEDESTRIAN FLOW (PEDS/MIN) | START QUEUE (VEHS) | END QUEUE (VEHS) | DELAY (VEH.MIN/ TIME SEGMENT) | GEOMETRIC DELAY (VEH.MIN/ TIME SEGMENT) | AVERAGE DELAY PER ARRIVING VEHICLE (MIN) | I |
|---|-------------|---------------------|-----------------------|------------------------------|----------------------------------|--------------------------|------------------------|-------------------------------------|---|--|---|
| I | 17.30-17.45 | | | | | | | | | | I |
| I | B-C | 0.06 | 11.67 | 0.005 | | 0.00 | 0.00 | 0.1 | | 0.09 | I |
| I | B-A | 0.28 | 10.66 | 0.026 | | 0.03 | 0.03 | 0.4 | | 0.10 | I |
| I | C-AB | 0.31 | 10.59 | 0.029 | | 0.03 | 0.03 | 0.5 | | 0.10 | I |
| I | A-B | 0.48 | | | | | | | | | I |
| I | A-C | 0.46 | | | | | | | | | I |

| I | TIME | DEMAND (VEH/MIN) | CAPACITY (VEH/MIN) | DEMAND/ CAPACITY (RFC) | PEDESTRIAN FLOW (PEDS/MIN) | START QUEUE (VEHS) | END QUEUE (VEHS) | DELAY (VEH.MIN/ TIME SEGMENT) | GEOMETRIC DELAY (VEH.MIN/ TIME SEGMENT) | AVERAGE DELAY PER ARRIVING VEHICLE (MIN) | I |
|---|-------------|---------------------|-----------------------|------------------------------|----------------------------------|--------------------------|------------------------|-------------------------------------|---|--|---|
| I | 17.45-18.00 | | | | | | | | | | I |
| I | B-C | 0.04 | 11.71 | 0.004 | | 0.00 | 0.00 | 0.1 | | 0.09 | I |
| I | B-A | 0.22 | 10.73 | 0.021 | | 0.03 | 0.02 | 0.3 | | 0.10 | I |
| I | C-AB | 0.25 | 10.63 | 0.024 | | 0.03 | 0.02 | 0.4 | | 0.10 | I |
| I | A-B | 0.39 | | | | | | | | | I |
| I | A-C | 0.37 | | | | | | | | | I |

| I | TIME | DEMAND (VEH/MIN) | CAPACITY (VEH/MIN) | DEMAND/ CAPACITY (RFC) | PEDESTRIAN FLOW (PEDS/MIN) | START QUEUE (VEHS) | END QUEUE (VEHS) | DELAY (VEH.MIN/ TIME SEGMENT) | GEOMETRIC DELAY (VEH.MIN/ TIME SEGMENT) | AVERAGE DELAY PER ARRIVING VEHICLE (MIN) | I |
|---|-------------|---------------------|-----------------------|------------------------------|----------------------------------|--------------------------|------------------------|-------------------------------------|---|--|---|
| I | 18.00-18.15 | | | | | | | | | | I |
| I | B-C | 0.04 | 11.75 | 0.003 | | 0.00 | 0.00 | 0.0 | | 0.09 | I |
| I | B-A | 0.19 | 10.79 | 0.017 | | 0.02 | 0.02 | 0.3 | | 0.09 | I |
| I | C-AB | 0.21 | 10.66 | 0.020 | | 0.02 | 0.02 | 0.3 | | 0.10 | I |
| I | A-B | 0.33 | | | | | | | | | I |
| I | A-C | 0.31 | | | | | | | | | I |

QUEUE FOR STREAM B-C

| TIME SEGMENT ENDING | NO. OF VEHICLES IN QUEUE |
|------------------------|--------------------------------|
| 17.00 | 0.0 |
| 17.15 | 0.0 |
| 17.30 | 0.0 |
| 17.45 | 0.0 |
| 18.00 | 0.0 |
| 18.15 | 0.0 |

QUEUE FOR STREAM B-A

| TIME SEGMENT ENDING | NO. OF VEHICLES IN QUEUE |
|------------------------|--------------------------------|
| 17.00 | 0.0 |
| 17.15 | 0.0 |
| 17.30 | 0.0 |
| 17.45 | 0.0 |
| 18.00 | 0.0 |
| 18.15 | 0.0 |

QUEUE FOR STREAM C-AB

| TIME SEGMENT ENDING | NO. OF VEHICLES IN QUEUE |
|---------------------|--------------------------|
| 17.00 | 0.0 |
| 17.15 | 0.0 |
| 17.30 | 0.0 |
| 17.45 | 0.0 |
| 18.00 | 0.0 |
| 18.15 | 0.0 |

QUEUEING DELAY INFORMATION OVER WHOLE PERIOD

| I | STREAM | I | TOTAL DEMAND | I | * QUEUEING * * DELAY * | I | * INCLUSIVE QUEUEING * * DELAY * | I | | |
|---|--------|-------|--------------|---|---------------------------|-----------|-------------------------------------|-------|-----------|---|
| I | I | (VEH) | (VEH/H) | I | (MIN) | (MIN/VEH) | I | (MIN) | (MIN/VEH) | I |
| I | B-C | I | 4.1 | I | 2.8 | I | 0.4 | I | 0.09 | I |
| I | B-A | I | 20.6 | I | 13.8 | I | 2.0 | I | 0.09 | I |
| I | C-AB | I | 23.4 | I | 15.6 | I | 2.3 | I | 0.10 | I |
| I | A-B | I | 35.8 | I | 23.9 | I | | I | | I |
| I | A-C | I | 34.4 | I | 22.9 | I | | I | | I |
| I | ALL | I | 141.8 | I | 94.5 | I | 4.6 | I | 0.03 | I |

* DELAY IS THAT OCCURRING ONLY WITHIN THE TIME PERIOD .
 * INCLUSIVE DELAY INCLUDES DELAY SUFFERED BY VEHICLES WHICH ARE STILL QUEUEING AFTER THE END OF THE TIME PERIOD.
 * THESE WILL ONLY BE SIGNIFICANTLY DIFFERENT IF THERE IS A LARGE QUEUE REMAINING AT THE END OF THE TIME PERIOD.

END OF JOB

===== end of file =====

TRL LIMITED

(C) COPYRIGHT 2006

CAPACITIES, QUEUES, AND DELAYS AT 3 OR 4-ARM MAJOR/MINOR PRIORITY JUNCTIONS

PICADY 5.0 ANALYSIS PROGRAM
RELEASE 3.0 (JUNE 2006)

ADAPTED FROM PICADY/3 WHICH IS CROWN COPYRIGHT
BY PERMISSION OF THE CONTROLLER OF HMSO

FOR SALES AND DISTRIBUTION INFORMATION,
PROGRAM ADVICE AND MAINTENANCE CONTACT:
TRL SOFTWARE BUREAU
TEL: CROWTHORNE (01344) 770758, FAX: 770864
EMAIL: SoftwareBureau@trl.co.uk

THE USER OF THIS COMPUTER PROGRAM FOR THE SOLUTION OF AN ENGINEERING PROBLEM IS
IN NO WAY RELIEVED OF HIS RESPONSIBILITY FOR THE CORRECTNESS OF THE SOLUTION

Run with file:-

"J:\120000\120669-00\4 Internal Project Data\4-04 Calculations\4-04-06 Junction Analysis\Picady\
Site 10. Camp Rd - B430 to Ardley\2013 Base\AM\Site 10. Camp Rd - Unnamed Rd 2013 Base AM.vpi"
(drive-on-the-left) at 11:24:54 on Wednesday, 11 July 2007

RUN INFORMATION

RUN TITLE: Site 10. Camp Road - Unnamed Rd towards B430 2013 Base AM

LOCATION: Oxfordshire

DATE: 09/11/06

CLIENT: North Oxfordshire Consortium

ENUMERATOR: Chris.Morris [MCCPC062011]

JOB NUMBER: 120669

STATUS: TIA

DESCRIPTION:

.MAJOR/MINOR JUNCTION CAPACITY AND DELAY

INPUT DATA

MAJOR ROAD (ARM C) ----- MAJOR ROAD (ARM A)

I
I
I
I
I
I
I

MINOR ROAD (ARM B)

ARM A IS Camp Rd (W)

ARM B IS Unnamed Rd (E) towards B430

ARM C IS Unnamed Rd (S) towards Middleton Stoney

STREAM LABELLING CONVENTION

STREAM A-B CONTAINS TRAFFIC GOING FROM ARM A TO ARM B

STREAM B-AC CONTAINS TRAFFIC GOING FROM ARM B TO ARM A AND TO ARM C

ETC.

 GEOMETRIC DATA

| I | DATA ITEM | I | MINOR ROAD B | I |
|---|------------------------------------|---|-----------------|---|
| I | TOTAL MAJOR ROAD CARRIAGEWAY WIDTH | I | (W) 6.10 M. | I |
| I | CENTRAL RESERVE WIDTH | I | (WCR) 0.00 M. | I |
| I | | I | | I |
| I | MAJOR ROAD RIGHT TURN - WIDTH | I | (WC-B) 2.20 M. | I |
| I | - VISIBILITY | I | (VC-B) 130.0 M. | I |
| I | - BLOCKS TRAFFIC | I | YES | I |
| I | | I | | I |
| I | MINOR ROAD - VISIBILITY TO LEFT | I | (VB-C) 120.0 M. | I |
| I | - VISIBILITY TO RIGHT | I | (VB-A) 145.0 M. | I |
| I | - LANE 1 WIDTH | I | (WB-C) - | I |
| I | - LANE 2 WIDTH | I | (WB-A) - | I |
| I | - WIDTH AT 0 M FROM JUNC. | I | 10.00 M. | I |
| I | - WIDTH AT 5 M FROM JUNC. | I | 6.00 M. | I |
| I | - WIDTH AT 10 M FROM JUNC. | I | 4.30 M. | I |
| I | - WIDTH AT 15 M FROM JUNC. | I | 3.40 M. | I |
| I | - WIDTH AT 20 M FROM JUNC. | I | 3.40 M. | I |
| I | - LENGTH OF FLARED SECTION | I | 1 VEHS | I |

 .SLOPES AND INTERCEPT

(NB:Streams may be combined, in which case capacity will be adjusted)

| I | Intercept For Stream B-C | Slope For Opposing Stream A-C | Slope For Opposing Stream A-B | I |
|---|--------------------------|-------------------------------|-------------------------------|---|
| I | 657.93 | 0.25 | 0.10 | I |

| I | Intercept For Stream B-A | Slope For Opposing Stream A-C | Slope For Opposing Stream A-B | Slope For Opposing Stream C-A | Slope For Opposing Stream C-B | I |
|---|--------------------------|-------------------------------|-------------------------------|-------------------------------|-------------------------------|---|
| I | 543.76 | 0.25 | 0.10 | 0.16 | 0.36 | I |

| I | Intercept For Stream C-B | Slope For Opposing Stream A-C | Slope For Opposing Stream A-B | I |
|---|--------------------------|-------------------------------|-------------------------------|---|
| I | 649.25 | 0.25 | 0.25 | I |

NB These values do not allow for any site specific corrections

 TRAFFIC DEMAND DATA

| I | TIME | DEMAND (VEH/MIN) | CAPACITY (VEH/MIN) | DEMAND/ CAPACITY (RFC) | PEDESTRIAN FLOW (PEDS/MIN) | START QUEUE (VEHS) | END QUEUE (VEHS) | DELAY (VEH.MIN/ TIME SEGMENT) | GEOMETRIC DELAY (VEH.MIN/ TIME SEGMENT) | AVERAGE DELAY PER ARRIVING VEHICLE (MIN) | I |
|---|-------------|---------------------|-----------------------|------------------------------|----------------------------------|--------------------------|------------------------|-------------------------------------|---|--|---|
| I | 08.15-08.30 | | | | | | | | | | I |
| I | B-C | 0.39 | 12.32 | 0.031 | | 0.03 | 0.03 | 0.5 | | 0.08 | I |
| I | B-A | 0.61 | 10.80 | 0.056 | | 0.05 | 0.06 | 0.9 | | 0.10 | I |
| I | C-AB | 0.17 | 10.56 | 0.016 | | 0.01 | 0.02 | 0.2 | | 0.10 | I |
| I | A-B | 0.48 | | | | | | | | | I |
| I | A-C | 0.55 | | | | | | | | | I |

| I | TIME | DEMAND (VEH/MIN) | CAPACITY (VEH/MIN) | DEMAND/ CAPACITY (RFC) | PEDESTRIAN FLOW (PEDS/MIN) | START QUEUE (VEHS) | END QUEUE (VEHS) | DELAY (VEH.MIN/ TIME SEGMENT) | GEOMETRIC DELAY (VEH.MIN/ TIME SEGMENT) | AVERAGE DELAY PER ARRIVING VEHICLE (MIN) | I |
|---|-------------|---------------------|-----------------------|------------------------------|----------------------------------|--------------------------|------------------------|-------------------------------------|---|--|---|
| I | 08.30-08.45 | | | | | | | | | | I |
| I | B-C | 0.39 | 12.32 | 0.031 | | 0.03 | 0.03 | 0.5 | | 0.08 | I |
| I | B-A | 0.61 | 10.80 | 0.056 | | 0.06 | 0.06 | 0.9 | | 0.10 | I |
| I | C-AB | 0.17 | 10.56 | 0.016 | | 0.02 | 0.02 | 0.2 | | 0.10 | I |
| I | A-B | 0.48 | | | | | | | | | I |
| I | A-C | 0.55 | | | | | | | | | I |

| I | TIME | DEMAND (VEH/MIN) | CAPACITY (VEH/MIN) | DEMAND/ CAPACITY (RFC) | PEDESTRIAN FLOW (PEDS/MIN) | START QUEUE (VEHS) | END QUEUE (VEHS) | DELAY (VEH.MIN/ TIME SEGMENT) | GEOMETRIC DELAY (VEH.MIN/ TIME SEGMENT) | AVERAGE DELAY PER ARRIVING VEHICLE (MIN) | I |
|---|-------------|---------------------|-----------------------|------------------------------|----------------------------------|--------------------------|------------------------|-------------------------------------|---|--|---|
| I | 08.45-09.00 | | | | | | | | | | I |
| I | B-C | 0.31 | 12.39 | 0.025 | | 0.03 | 0.03 | 0.4 | | 0.08 | I |
| I | B-A | 0.49 | 10.86 | 0.046 | | 0.06 | 0.05 | 0.7 | | 0.10 | I |
| I | C-AB | 0.13 | 10.61 | 0.013 | | 0.02 | 0.01 | 0.2 | | 0.10 | I |
| I | A-B | 0.39 | | | | | | | | | I |
| I | A-C | 0.45 | | | | | | | | | I |

| I | TIME | DEMAND (VEH/MIN) | CAPACITY (VEH/MIN) | DEMAND/ CAPACITY (RFC) | PEDESTRIAN FLOW (PEDS/MIN) | START QUEUE (VEHS) | END QUEUE (VEHS) | DELAY (VEH.MIN/ TIME SEGMENT) | GEOMETRIC DELAY (VEH.MIN/ TIME SEGMENT) | AVERAGE DELAY PER ARRIVING VEHICLE (MIN) | I |
|---|-------------|---------------------|-----------------------|------------------------------|----------------------------------|--------------------------|------------------------|-------------------------------------|---|--|---|
| I | 09.00-09.15 | | | | | | | | | | I |
| I | B-C | 0.26 | 12.45 | 0.021 | | 0.03 | 0.02 | 0.3 | | 0.08 | I |
| I | B-A | 0.41 | 10.91 | 0.038 | | 0.05 | 0.04 | 0.6 | | 0.10 | I |
| I | C-AB | 0.11 | 10.64 | 0.011 | | 0.01 | 0.01 | 0.2 | | 0.10 | I |
| I | A-B | 0.33 | | | | | | | | | I |
| I | A-C | 0.38 | | | | | | | | | I |

QUEUE FOR STREAM B-C

| TIME SEGMENT ENDING | NO. OF VEHICLES IN QUEUE |
|------------------------|--------------------------------|
| 08.00 | 0.0 |
| 08.15 | 0.0 |
| 08.30 | 0.0 |
| 08.45 | 0.0 |
| 09.00 | 0.0 |
| 09.15 | 0.0 |

QUEUE FOR STREAM B-A

| TIME SEGMENT ENDING | NO. OF VEHICLES IN QUEUE |
|------------------------|--------------------------------|
| 08.00 | 0.0 |
| 08.15 | 0.0 |
| 08.30 | 0.1 |
| 08.45 | 0.1 |
| 09.00 | 0.0 |
| 09.15 | 0.0 |

QUEUE FOR STREAM C-AB

| TIME SEGMENT ENDING | NO. OF VEHICLES IN QUEUE |
|---------------------|--------------------------|
| 08.00 | 0.0 |
| 08.15 | 0.0 |
| 08.30 | 0.0 |
| 08.45 | 0.0 |
| 09.00 | 0.0 |
| 09.15 | 0.0 |

QUEUEING DELAY INFORMATION OVER WHOLE PERIOD

| I | STREAM | I | TOTAL DEMAND | I | * QUEUEING * * DELAY * | I | * INCLUSIVE QUEUEING * * DELAY * | I | | |
|---|--------|-------|--------------|---|---------------------------|-----------|-------------------------------------|-------|-----------|---|
| I | I | (VEH) | (VEH/H) | I | (MIN) | (MIN/VEH) | I | (MIN) | (MIN/VEH) | I |
| I | B-C | I | 28.9 | I | 19.3 | I | 2.4 | I | 0.08 | I |
| I | B-A | I | 45.4 | I | 30.3 | I | 4.4 | I | 0.10 | I |
| I | C-AB | I | 12.4 | I | 8.3 | I | 1.2 | I | 0.10 | I |
| I | A-B | I | 35.8 | I | 23.9 | I | | I | | I |
| I | A-C | I | 41.3 | I | 27.5 | I | | I | | I |
| I | ALL | I | 191.3 | I | 127.5 | I | 7.9 | I | 0.04 | I |

* DELAY IS THAT OCCURRING ONLY WITHIN THE TIME PERIOD .
 * INCLUSIVE DELAY INCLUDES DELAY SUFFERED BY VEHICLES WHICH ARE STILL QUEUEING AFTER THE END OF THE TIME PERIOD.
 * THESE WILL ONLY BE SIGNIFICANTLY DIFFERENT IF THERE IS A LARGE QUEUE REMAINING AT THE END OF THE TIME PERIOD.

END OF JOB

===== end of file =====

TRL LIMITED

(C) COPYRIGHT 2006

CAPACITIES, QUEUES, AND DELAYS AT 3 OR 4-ARM MAJOR/MINOR PRIORITY JUNCTIONS

PICADY 5.0 ANALYSIS PROGRAM
RELEASE 3.0 (JUNE 2006)

ADAPTED FROM PICADY/3 WHICH IS CROWN COPYRIGHT
BY PERMISSION OF THE CONTROLLER OF HMSO

FOR SALES AND DISTRIBUTION INFORMATION,
PROGRAM ADVICE AND MAINTENANCE CONTACT:
TRL SOFTWARE BUREAU
TEL: CROWTHORNE (01344) 770758, FAX: 770864
EMAIL: SoftwareBureau@trl.co.uk

THE USER OF THIS COMPUTER PROGRAM FOR THE SOLUTION OF AN ENGINEERING PROBLEM IS
IN NO WAY RELIEVED OF HIS RESPONSIBILITY FOR THE CORRECTNESS OF THE SOLUTION

Run with file:-
"J:\120000\120669-00\4 Internal Project Data\4-04 Calculations\4-04-06 Junction Analysis\Picady\
Site 10. Camp Rd - B430 to Ardley\2013 Base\PM\Site 10. Camp Rd - Unnamed Rd 2013 Base PM.vpi"
(drive-on-the-left) at 11:29:13 on Wednesday, 11 July 2007

RUN INFORMATION

RUN TITLE: Site 10. Camp Road - Unnamed Rd towards B430 2013 Base PM
LOCATION: Oxfordshire
DATE: 09/11/06
CLIENT: North Oxfordshire Consortium
ENUMERATOR: Chris.Morris [MCCPC062011]
JOB NUMBER: 120669
STATUS: TIA
DESCRIPTION:

.MAJOR/MINOR JUNCTION CAPACITY AND DELAY

INPUT DATA

MAJOR ROAD (ARM C) ----- MAJOR ROAD (ARM A)
I
I
I
I
I
I
MINOR ROAD (ARM B)

ARM A IS Camp Rd (W)
ARM B IS Unnamed Rd (E) towards B430
ARM C IS Unnamed Rd (S) towards Middleton Stoney

STREAM LABELLING CONVENTION

STREAM A-B CONTAINS TRAFFIC GOING FROM ARM A TO ARM B
STREAM B-AC CONTAINS TRAFFIC GOING FROM ARM B TO ARM A AND TO ARM C
ETC.

 GEOMETRIC DATA

| I | DATA ITEM | I | MINOR ROAD B | I |
|---|------------------------------------|---|-----------------|---|
| I | TOTAL MAJOR ROAD CARRIAGEWAY WIDTH | I | (W) 6.10 M. | I |
| I | CENTRAL RESERVE WIDTH | I | (WCR) 0.00 M. | I |
| I | | I | | I |
| I | MAJOR ROAD RIGHT TURN - WIDTH | I | (WC-B) 2.20 M. | I |
| I | - VISIBILITY | I | (VC-B) 130.0 M. | I |
| I | - BLOCKS TRAFFIC | I | YES | I |
| I | | I | | I |
| I | MINOR ROAD - VISIBILITY TO LEFT | I | (VB-C) 120.0 M. | I |
| I | - VISIBILITY TO RIGHT | I | (VB-A) 145.0 M. | I |
| I | - LANE 1 WIDTH | I | (WB-C) - | I |
| I | - LANE 2 WIDTH | I | (WB-A) - | I |
| I | - WIDTH AT 0 M FROM JUNC. | I | 10.00 M. | I |
| I | - WIDTH AT 5 M FROM JUNC. | I | 6.00 M. | I |
| I | - WIDTH AT 10 M FROM JUNC. | I | 4.30 M. | I |
| I | - WIDTH AT 15 M FROM JUNC. | I | 3.40 M. | I |
| I | - WIDTH AT 20 M FROM JUNC. | I | 3.40 M. | I |
| I | - LENGTH OF FLARED SECTION | I | 1 VEHS | I |

 .SLOPES AND INTERCEPT

(NB:Streams may be combined, in which case capacity will be adjusted)

| I | Intercept For Stream B-C | Slope For Opposing Stream A-C | Slope For Opposing Stream A-B | I |
|---|--------------------------|-------------------------------|-------------------------------|---|
| I | 657.93 | 0.25 | 0.10 | I |

| I | Intercept For Stream B-A | Slope For Opposing Stream A-C | Slope For Opposing Stream A-B | Slope For Opposing Stream C-A | Slope For Opposing Stream C-B | I |
|---|--------------------------|-------------------------------|-------------------------------|-------------------------------|-------------------------------|---|
| I | 543.76 | 0.25 | 0.10 | 0.16 | 0.36 | I |

| I | Intercept For Stream C-B | Slope For Opposing Stream A-C | Slope For Opposing Stream A-B | I |
|---|--------------------------|-------------------------------|-------------------------------|---|
| I | 649.25 | 0.25 | 0.25 | I |

NB These values do not allow for any site specific corrections

 TRAFFIC DEMAND DATA

| I | TIME | DEMAND (VEH/MIN) | CAPACITY (VEH/MIN) | DEMAND/ CAPACITY (RFC) | PEDESTRIAN FLOW (PEDS/MIN) | START QUEUE (VEHS) | END QUEUE (VEHS) | DELAY (VEH.MIN/ TIME SEGMENT) | GEOMETRIC DELAY (VEH.MIN/ TIME SEGMENT) | AVERAGE DELAY PER ARRIVING VEHICLE (MIN) | I |
|---|-------------|---------------------|-----------------------|------------------------------|----------------------------------|--------------------------|------------------------|-------------------------------------|---|--|---|
| I | 17.15-17.30 | | | | | | | | | | I |
| I | B-C | 0.07 | 11.71 | 0.006 | | 0.01 | 0.01 | 0.1 | | 0.09 | I |
| I | B-A | 0.31 | 10.58 | 0.029 | | 0.02 | 0.03 | 0.4 | | 0.10 | I |
| I | C-AB | 0.37 | 10.55 | 0.035 | | 0.03 | 0.04 | 0.5 | | 0.10 | I |
| I | A-B | 0.55 | | | | | | | | | I |
| I | A-C | 0.51 | | | | | | | | | I |

| I | TIME | DEMAND (VEH/MIN) | CAPACITY (VEH/MIN) | DEMAND/ CAPACITY (RFC) | PEDESTRIAN FLOW (PEDS/MIN) | START QUEUE (VEHS) | END QUEUE (VEHS) | DELAY (VEH.MIN/ TIME SEGMENT) | GEOMETRIC DELAY (VEH.MIN/ TIME SEGMENT) | AVERAGE DELAY PER ARRIVING VEHICLE (MIN) | I |
|---|-------------|---------------------|-----------------------|------------------------------|----------------------------------|--------------------------|------------------------|-------------------------------------|---|--|---|
| I | 17.30-17.45 | | | | | | | | | | I |
| I | B-C | 0.07 | 11.71 | 0.006 | | 0.01 | 0.01 | 0.1 | | 0.09 | I |
| I | B-A | 0.31 | 10.58 | 0.029 | | 0.03 | 0.03 | 0.5 | | 0.10 | I |
| I | C-AB | 0.37 | 10.55 | 0.035 | | 0.04 | 0.04 | 0.5 | | 0.10 | I |
| I | A-B | 0.55 | | | | | | | | | I |
| I | A-C | 0.51 | | | | | | | | | I |

| I | TIME | DEMAND (VEH/MIN) | CAPACITY (VEH/MIN) | DEMAND/ CAPACITY (RFC) | PEDESTRIAN FLOW (PEDS/MIN) | START QUEUE (VEHS) | END QUEUE (VEHS) | DELAY (VEH.MIN/ TIME SEGMENT) | GEOMETRIC DELAY (VEH.MIN/ TIME SEGMENT) | AVERAGE DELAY PER ARRIVING VEHICLE (MIN) | I |
|---|-------------|---------------------|-----------------------|------------------------------|----------------------------------|--------------------------|------------------------|-------------------------------------|---|--|---|
| I | 17.45-18.00 | | | | | | | | | | I |
| I | B-C | 0.06 | 11.77 | 0.005 | | 0.01 | 0.01 | 0.1 | | 0.09 | I |
| I | B-A | 0.25 | 10.66 | 0.024 | | 0.03 | 0.02 | 0.4 | | 0.10 | I |
| I | C-AB | 0.30 | 10.60 | 0.028 | | 0.04 | 0.03 | 0.4 | | 0.10 | I |
| I | A-B | 0.45 | | | | | | | | | I |
| I | A-C | 0.42 | | | | | | | | | I |

| I | TIME | DEMAND (VEH/MIN) | CAPACITY (VEH/MIN) | DEMAND/ CAPACITY (RFC) | PEDESTRIAN FLOW (PEDS/MIN) | START QUEUE (VEHS) | END QUEUE (VEHS) | DELAY (VEH.MIN/ TIME SEGMENT) | GEOMETRIC DELAY (VEH.MIN/ TIME SEGMENT) | AVERAGE DELAY PER ARRIVING VEHICLE (MIN) | I |
|---|-------------|---------------------|-----------------------|------------------------------|----------------------------------|--------------------------|------------------------|-------------------------------------|---|--|---|
| I | 18.00-18.15 | | | | | | | | | | I |
| I | B-C | 0.05 | 11.81 | 0.004 | | 0.01 | 0.00 | 0.1 | | 0.09 | I |
| I | B-A | 0.21 | 10.72 | 0.020 | | 0.02 | 0.02 | 0.3 | | 0.10 | I |
| I | C-AB | 0.25 | 10.64 | 0.024 | | 0.03 | 0.02 | 0.4 | | 0.10 | I |
| I | A-B | 0.38 | | | | | | | | | I |
| I | A-C | 0.35 | | | | | | | | | I |

QUEUE FOR STREAM B-C

| TIME SEGMENT ENDING | NO. OF VEHICLES IN QUEUE |
|------------------------|--------------------------------|
| 17.00 | 0.0 |
| 17.15 | 0.0 |
| 17.30 | 0.0 |
| 17.45 | 0.0 |
| 18.00 | 0.0 |
| 18.15 | 0.0 |

QUEUE FOR STREAM B-A

| TIME SEGMENT ENDING | NO. OF VEHICLES IN QUEUE |
|------------------------|--------------------------------|
| 17.00 | 0.0 |
| 17.15 | 0.0 |
| 17.30 | 0.0 |
| 17.45 | 0.0 |
| 18.00 | 0.0 |
| 18.15 | 0.0 |

QUEUE FOR STREAM C-AB

| TIME SEGMENT ENDING | NO. OF VEHICLES IN QUEUE |
|---------------------|--------------------------|
| 17.00 | 0.0 |
| 17.15 | 0.0 |
| 17.30 | 0.0 |
| 17.45 | 0.0 |
| 18.00 | 0.0 |
| 18.15 | 0.0 |

QUEUEING DELAY INFORMATION OVER WHOLE PERIOD

| I | STREAM | I | TOTAL DEMAND | I | * QUEUEING * | I | * INCLUSIVE QUEUEING * | I |
|---|--------|---|--------------|---|--------------|---|------------------------|---|
| I | I | I | (VEH) | I | (MIN) | I | (MIN) | I |
| I | I | I | (VEH/H) | I | (MIN/VEH) | I | (MIN/VEH) | I |
| I | B-C | I | 5.5 | I | 0.5 | I | 0.09 | I |
| I | B-A | I | 23.4 | I | 2.2 | I | 0.10 | I |
| I | C-AB | I | 27.5 | I | 2.7 | I | 0.10 | I |
| I | A-B | I | 41.3 | I | | I | | I |
| I | A-C | I | 38.5 | I | | I | | I |
| I | ALL | I | 162.4 | I | 5.4 | I | 0.03 | I |

* DELAY IS THAT OCCURRING ONLY WITHIN THE TIME PERIOD .
 * INCLUSIVE DELAY INCLUDES DELAY SUFFERED BY VEHICLES WHICH ARE STILL QUEUEING AFTER THE END OF THE TIME PERIOD.
 * THESE WILL ONLY BE SIGNIFICANTLY DIFFERENT IF THERE IS A LARGE QUEUE REMAINING AT THE END OF THE TIME PERIOD.

END OF JOB

===== end of file =====

TRL LIMITED

(C) COPYRIGHT 2006

CAPACITIES, QUEUES, AND DELAYS AT 3 OR 4-ARM MAJOR/MINOR PRIORITY JUNCTIONS

PICADY 5.0 ANALYSIS PROGRAM
RELEASE 3.0 (JUNE 2006)

ADAPTED FROM PICADY/3 WHICH IS CROWN COPYRIGHT
BY PERMISSION OF THE CONTROLLER OF HMSO

FOR SALES AND DISTRIBUTION INFORMATION,
PROGRAM ADVICE AND MAINTENANCE CONTACT:
TRL SOFTWARE BUREAU
TEL: CROWTHORNE (01344) 770758, FAX: 770864
EMAIL: SoftwareBureau@trl.co.uk

THE USER OF THIS COMPUTER PROGRAM FOR THE SOLUTION OF AN ENGINEERING PROBLEM IS
IN NO WAY RELIEVED OF HIS RESPONSIBILITY FOR THE CORRECTNESS OF THE SOLUTION

Run with file:-

"J:\120000\120669-00\4 Internal Project Data\4-04 Calculations\4-04-06 Junction Analysis\Picady\
Site 10. Camp Rd - B430 to Ardley\2013 Base + Gen\AM\
Site 10. Camp Rd - Unnamed Rd 2013 Base + Full Development AM.vpi"
(drive-on-the-left) at 11:15:02 on Tuesday, 31 July 2007

RUN INFORMATION

RUN TITLE: Site 10. Camp Road - Unnamed Rd towards B430 2013 Base + Full Development AM
LOCATION: Oxfordshire
DATE: 31/07/07
CLIENT: North Oxfordshire Consortium
ENUMERATOR: Ian Clarke
JOB NUMBER: 120669
STATUS: TIA

DESCRIPTION:

.MAJOR/MINOR JUNCTION CAPACITY AND DELAY

INPUT DATA

MAJOR ROAD (ARM C) ----- MAJOR ROAD (ARM A)
I
I
I
I
I
I
MINOR ROAD (ARM B)

ARM A IS Camp Rd (W)
ARM B IS Unnamed Rd (E) towards B430
ARM C IS Unnamed Rd (S) towards Middleton Stoney

STREAM LABELLING CONVENTION

STREAM A-B CONTAINS TRAFFIC GOING FROM ARM A TO ARM B
STREAM B-AC CONTAINS TRAFFIC GOING FROM ARM B TO ARM A AND TO ARM C
ETC.

 GEOMETRIC DATA

| DATA ITEM | MINOR ROAD B |
|------------------------------------|-----------------|
| TOTAL MAJOR ROAD CARRIAGEWAY WIDTH | (W) 6.10 M. |
| CENTRAL RESERVE WIDTH | (WCR) 0.00 M. |
| MAJOR ROAD RIGHT TURN - WIDTH | (WC-B) 2.20 M. |
| - VISIBILITY | (VC-B) 130.0 M. |
| - BLOCKS TRAFFIC | YES |
| MINOR ROAD - VISIBILITY TO LEFT | (VB-C) 120.0 M. |
| - VISIBILITY TO RIGHT | (VB-A) 145.0 M. |
| - LANE 1 WIDTH | (WB-C) - |
| - LANE 2 WIDTH | (WB-A) - |
| - WIDTH AT 0 M FROM JUNC. | 10.00 M. |
| - WIDTH AT 5 M FROM JUNC. | 6.00 M. |
| - WIDTH AT 10 M FROM JUNC. | 4.30 M. |
| - WIDTH AT 15 M FROM JUNC. | 3.40 M. |
| - WIDTH AT 20 M FROM JUNC. | 3.40 M. |
| - LENGTH OF FLARED SECTION | 1 VEHS |

 .SLOPES AND INTERCEPT

(NB:Streams may be combined, in which case capacity will be adjusted)

| Intercept For Stream B-C | Slope For Opposing Stream A-C | Slope For Opposing Stream A-B |
|--------------------------|-------------------------------|-------------------------------|
| 657.93 | 0.25 | 0.10 |

| Intercept For Stream B-A | Slope For Opposing Stream A-C | Slope For Opposing Stream A-B | Slope For Opposing Stream C-A | Slope For Opposing Stream C-B |
|--------------------------|-------------------------------|-------------------------------|-------------------------------|-------------------------------|
| 543.76 | 0.25 | 0.10 | 0.16 | 0.36 |

| Intercept For Stream C-B | Slope For Opposing Stream A-C | Slope For Opposing Stream A-B |
|--------------------------|-------------------------------|-------------------------------|
| 649.25 | 0.25 | 0.25 |

NB These values do not allow for any site specific corrections

 TRAFFIC DEMAND DATA

| I | TIME | DEMAND (VEH/MIN) | CAPACITY (VEH/MIN) | DEMAND/ CAPACITY (RFC) | PEDESTRIAN FLOW (PEDS/MIN) | START QUEUE (VEHS) | END QUEUE (VEHS) | DELAY (VEH.MIN/ TIME SEGMENT) | GEOMETRIC DELAY (VEH.MIN/ TIME SEGMENT) | AVERAGE DELAY PER ARRIVING VEHICLE (MIN) | I |
|---|-------------|---------------------|-----------------------|------------------------------|----------------------------------|--------------------------|------------------------|-------------------------------------|---|--|---|
| I | 08.15-08.30 | | | | | | | | | | I |
| I | B-C | 0.39 | 1.49 | 0.258 | | 0.06 | 0.32 | 4.2 | | 0.88 | I |
| I | B-A | 6.92 | 7.48 | 0.925 | | 2.10 | 6.68 | 76.2 | | 0.93 | I |
| I | C-AB | 0.17 | 7.84 | 0.021 | | 0.02 | 0.02 | 0.3 | | 0.13 | I |
| I | A-B | 5.23 | | | | | | | | | I |
| I | A-C | 6.66 | | | | | | | | | I |

| I | TIME | DEMAND (VEH/MIN) | CAPACITY (VEH/MIN) | DEMAND/ CAPACITY (RFC) | PEDESTRIAN FLOW (PEDS/MIN) | START QUEUE (VEHS) | END QUEUE (VEHS) | DELAY (VEH.MIN/ TIME SEGMENT) | GEOMETRIC DELAY (VEH.MIN/ TIME SEGMENT) | AVERAGE DELAY PER ARRIVING VEHICLE (MIN) | I |
|---|-------------|---------------------|-----------------------|------------------------------|----------------------------------|--------------------------|------------------------|-------------------------------------|---|--|---|
| I | 08.30-08.45 | | | | | | | | | | I |
| I | B-C | 0.39 | 0.71 | 0.546 | | 0.32 | 0.89 | 10.6 | | 2.57 | I |
| I | B-A | 6.92 | 7.47 | 0.926 | | 6.68 | 8.14 | 112.4 | | 1.27 | I |
| I | C-AB | 0.17 | 7.84 | 0.021 | | 0.02 | 0.02 | 0.3 | | 0.13 | I |
| I | A-B | 5.23 | | | | | | | | | I |
| I | A-C | 6.66 | | | | | | | | | I |

| I | TIME | DEMAND (VEH/MIN) | CAPACITY (VEH/MIN) | DEMAND/ CAPACITY (RFC) | PEDESTRIAN FLOW (PEDS/MIN) | START QUEUE (VEHS) | END QUEUE (VEHS) | DELAY (VEH.MIN/ TIME SEGMENT) | GEOMETRIC DELAY (VEH.MIN/ TIME SEGMENT) | AVERAGE DELAY PER ARRIVING VEHICLE (MIN) | I |
|---|-------------|---------------------|-----------------------|------------------------------|----------------------------------|--------------------------|------------------------|-------------------------------------|---|--|---|
| I | 08.45-09.00 | | | | | | | | | | I |
| I | B-C | 0.31 | 4.71 | 0.067 | | 0.89 | 0.07 | 1.3 | | 0.23 | I |
| I | B-A | 5.65 | 8.14 | 0.694 | | 8.14 | 2.47 | 49.4 | | 0.54 | I |
| I | C-AB | 0.13 | 8.39 | 0.016 | | 0.02 | 0.02 | 0.2 | | 0.12 | I |
| I | A-B | 4.27 | | | | | | | | | I |
| I | A-C | 5.44 | | | | | | | | | I |

| I | TIME | DEMAND (VEH/MIN) | CAPACITY (VEH/MIN) | DEMAND/ CAPACITY (RFC) | PEDESTRIAN FLOW (PEDS/MIN) | START QUEUE (VEHS) | END QUEUE (VEHS) | DELAY (VEH.MIN/ TIME SEGMENT) | GEOMETRIC DELAY (VEH.MIN/ TIME SEGMENT) | AVERAGE DELAY PER ARRIVING VEHICLE (MIN) | I |
|---|-------------|---------------------|-----------------------|------------------------------|----------------------------------|--------------------------|------------------------|-------------------------------------|---|--|---|
| I | 09.00-09.15 | | | | | | | | | | I |
| I | B-C | 0.26 | 7.28 | 0.036 | | 0.07 | 0.04 | 0.6 | | 0.14 | I |
| I | B-A | 4.73 | 8.62 | 0.549 | | 2.47 | 1.26 | 20.4 | | 0.27 | I |
| I | C-AB | 0.11 | 8.78 | 0.013 | | 0.02 | 0.01 | 0.2 | | 0.12 | I |
| I | A-B | 3.58 | | | | | | | | | I |
| I | A-C | 4.55 | | | | | | | | | I |

QUEUE FOR STREAM B-C

| TIME SEGMENT ENDING | NO. OF VEHICLES IN QUEUE |
|------------------------|--------------------------------|
| 08.00 | 0.0 |
| 08.15 | 0.1 |
| 08.30 | 0.3 |
| 08.45 | 0.9 * |
| 09.00 | 0.1 |
| 09.15 | 0.0 |

QUEUE FOR STREAM B-A

| TIME SEGMENT ENDING | NO. OF VEHICLES IN QUEUE |
|------------------------|--------------------------------|
| 08.00 | 1.2 * |
| 08.15 | 2.1 ** |
| 08.30 | 6.7 ***** |
| 08.45 | 8.1 ***** |
| 09.00 | 2.5 ** |
| 09.15 | 1.3 * |

QUEUE FOR STREAM C-AB

| TIME SEGMENT ENDING | NO. OF VEHICLES IN QUEUE |
|---------------------|--------------------------|
| 08.00 | 0.0 |
| 08.15 | 0.0 |
| 08.30 | 0.0 |
| 08.45 | 0.0 |
| 09.00 | 0.0 |
| 09.15 | 0.0 |

QUEUEING DELAY INFORMATION OVER WHOLE PERIOD

| I | STREAM | I | TOTAL DEMAND | I | * QUEUEING * | I | * INCLUSIVE QUEUEING * | I | | |
|---|--------|-------|--------------|---|--------------|-----------|------------------------|-----------|------|---|
| I | I | I | I | I | * DELAY * | I | * DELAY * | I | | |
| I | I | (VEH) | (VEH/H) | I | (MIN) | (MIN/VEH) | I | (MIN) | | |
| I | I | I | I | I | I | I | I | (MIN/VEH) | | |
| I | B-C | I | 28.9 | I | 19.3 | I | 18.1 | I | 0.63 | I |
| I | B-A | I | 518.9 | I | 345.9 | I | 303.1 | I | 0.58 | I |
| I | C-AB | I | 12.4 | I | 8.3 | I | 1.5 | I | 0.12 | I |
| I | A-B | I | 392.3 | I | 261.5 | I | | I | | I |
| I | A-C | I | 499.6 | I | 333.1 | I | | I | | I |
| I | ALL | I | 1778.3 | I | 1185.6 | I | 322.8 | I | 0.18 | I |

* DELAY IS THAT OCCURRING ONLY WITHIN THE TIME PERIOD .
 * INCLUSIVE DELAY INCLUDES DELAY SUFFERED BY VEHICLES WHICH ARE STILL QUEUEING AFTER THE END OF THE TIME PERIOD.
 * THESE WILL ONLY BE SIGNIFICANTLY DIFFERENT IF THERE IS A LARGE QUEUE REMAINING AT THE END OF THE TIME PERIOD.

END OF JOB

===== end of file =====

TRL LIMITED

(C) COPYRIGHT 2006

CAPACITIES, QUEUES, AND DELAYS AT 3 OR 4-ARM MAJOR/MINOR PRIORITY JUNCTIONS

PICADY 5.0 ANALYSIS PROGRAM
RELEASE 3.0 (JUNE 2006)

ADAPTED FROM PICADY/3 WHICH IS CROWN COPYRIGHT
BY PERMISSION OF THE CONTROLLER OF HMSO

FOR SALES AND DISTRIBUTION INFORMATION,
PROGRAM ADVICE AND MAINTENANCE CONTACT:
TRL SOFTWARE BUREAU
TEL: CROWTHORNE (01344) 770758, FAX: 770864
EMAIL: SoftwareBureau@trl.co.uk

THE USER OF THIS COMPUTER PROGRAM FOR THE SOLUTION OF AN ENGINEERING PROBLEM IS
IN NO WAY RELIEVED OF HIS RESPONSIBILITY FOR THE CORRECTNESS OF THE SOLUTION

Run with file:-

"J:\120000\120669-00\4 Internal Project Data\4-04 Calculations\4-04-06 Junction Analysis\Picady\
Site 10. Camp Rd - B430 to Ardley\2013 Base + Gen\PM\
Site 10. Camp Rd - Unnamed Rd 2013 Base + Full Development PM.vpi"
(drive-on-the-left) at 17:30:21 on Tuesday, 7 August 2007

RUN INFORMATION

RUN TITLE: Site 10. Camp Road - Unnamed Rd towards B430 2013 Base + Full Development PM
LOCATION: Oxfordshire
DATE: 07/08/07
CLIENT: North Oxfordshire Consortium
ENUMERATOR: Ian Clarke
JOB NUMBER: 120669
STATUS: TIA
DESCRIPTION:

.MAJOR/MINOR JUNCTION CAPACITY AND DELAY

INPUT DATA

MAJOR ROAD (ARM C) ----- MAJOR ROAD (ARM A)
I
I
I
I
I
I
MINOR ROAD (ARM B)

ARM A IS Camp Rd (W)
ARM B IS Unnamed Rd (E) towards B430
ARM C IS Unnamed Rd (S) towards Middleton Stoney

STREAM LABELLING CONVENTION

STREAM A-B CONTAINS TRAFFIC GOING FROM ARM A TO ARM B
STREAM B-AC CONTAINS TRAFFIC GOING FROM ARM B TO ARM A AND TO ARM C
ETC.

 GEOMETRIC DATA

| DATA ITEM | MINOR ROAD B |
|------------------------------------|-----------------|
| TOTAL MAJOR ROAD CARRIAGEWAY WIDTH | (W) 6.10 M. |
| CENTRAL RESERVE WIDTH | (WCR) 0.00 M. |
| MAJOR ROAD RIGHT TURN - WIDTH | (WC-B) 2.20 M. |
| - VISIBILITY | (VC-B) 130.0 M. |
| - BLOCKS TRAFFIC | YES |
| MINOR ROAD - VISIBILITY TO LEFT | (VB-C) 120.0 M. |
| - VISIBILITY TO RIGHT | (VB-A) 145.0 M. |
| - LANE 1 WIDTH | (WB-C) - |
| - LANE 2 WIDTH | (WB-A) - |
| - WIDTH AT 0 M FROM JUNC. | 10.00 M. |
| - WIDTH AT 5 M FROM JUNC. | 6.00 M. |
| - WIDTH AT 10 M FROM JUNC. | 4.30 M. |
| - WIDTH AT 15 M FROM JUNC. | 3.40 M. |
| - WIDTH AT 20 M FROM JUNC. | 3.40 M. |
| - LENGTH OF FLARED SECTION | 1 VEHS |

 .SLOPES AND INTERCEPT

(NB:Streams may be combined, in which case capacity will be adjusted)

| Intercept For Stream B-C | Slope For Opposing Stream A-C | Slope For Opposing Stream A-B |
|--------------------------|-------------------------------|-------------------------------|
| 657.93 | 0.25 | 0.10 |

| Intercept For Stream B-A | Slope For Opposing Stream A-C | Slope For Opposing Stream A-B | Slope For Opposing Stream C-A | Slope For Opposing Stream C-B |
|--------------------------|-------------------------------|-------------------------------|-------------------------------|-------------------------------|
| 543.76 | 0.25 | 0.10 | 0.16 | 0.36 |

| Intercept For Stream C-B | Slope For Opposing Stream A-C | Slope For Opposing Stream A-B |
|--------------------------|-------------------------------|-------------------------------|
| 649.25 | 0.25 | 0.25 |

NB These values do not allow for any site specific corrections

 TRAFFIC DEMAND DATA

| I | TIME | DEMAND (VEH/MIN) | CAPACITY (VEH/MIN) | DEMAND/ CAPACITY (RFC) | PEDESTRIAN FLOW (PEDS/MIN) | START QUEUE (VEHS) | END QUEUE (VEHS) | DELAY (VEH.MIN/ TIME SEGMENT) | GEOMETRIC DELAY (VEH.MIN/ TIME SEGMENT) | AVERAGE DELAY PER ARRIVING VEHICLE (MIN) | I |
|---|-------------|---------------------|-----------------------|------------------------------|----------------------------------|--------------------------|------------------------|-------------------------------------|---|--|---|
| I | 08.15-08.30 | | | | | | | | | | I |
| I | B-C | 0.07 | 6.08 | 0.012 | | 0.01 | 0.01 | 0.2 | | 0.17 | I |
| I | B-A | 4.66 | 7.41 | 0.629 | | 0.87 | 1.60 | 22.0 | | 0.35 | I |
| I | C-AB | 0.37 | 7.77 | 0.047 | | 0.04 | 0.05 | 0.8 | | 0.14 | I |
| I | A-B | 6.90 | | | | | | | | | I |
| I | A-C | 5.27 | | | | | | | | | I |

| I | TIME | DEMAND (VEH/MIN) | CAPACITY (VEH/MIN) | DEMAND/ CAPACITY (RFC) | PEDESTRIAN FLOW (PEDS/MIN) | START QUEUE (VEHS) | END QUEUE (VEHS) | DELAY (VEH.MIN/ TIME SEGMENT) | GEOMETRIC DELAY (VEH.MIN/ TIME SEGMENT) | AVERAGE DELAY PER ARRIVING VEHICLE (MIN) | I |
|---|-------------|---------------------|-----------------------|------------------------------|----------------------------------|--------------------------|------------------------|-------------------------------------|---|--|---|
| I | 08.30-08.45 | | | | | | | | | | I |
| I | B-C | 0.07 | 6.01 | 0.012 | | 0.01 | 0.01 | 0.2 | | 0.17 | I |
| I | B-A | 4.66 | 7.41 | 0.629 | | 1.60 | 1.65 | 24.4 | | 0.36 | I |
| I | C-AB | 0.37 | 7.77 | 0.047 | | 0.05 | 0.05 | 0.8 | | 0.14 | I |
| I | A-B | 6.90 | | | | | | | | | I |
| I | A-C | 5.27 | | | | | | | | | I |

| I | TIME | DEMAND (VEH/MIN) | CAPACITY (VEH/MIN) | DEMAND/ CAPACITY (RFC) | PEDESTRIAN FLOW (PEDS/MIN) | START QUEUE (VEHS) | END QUEUE (VEHS) | DELAY (VEH.MIN/ TIME SEGMENT) | GEOMETRIC DELAY (VEH.MIN/ TIME SEGMENT) | AVERAGE DELAY PER ARRIVING VEHICLE (MIN) | I |
|---|-------------|---------------------|-----------------------|------------------------------|----------------------------------|--------------------------|------------------------|-------------------------------------|---|--|---|
| I | 08.45-09.00 | | | | | | | | | | I |
| I | B-C | 0.06 | 7.89 | 0.008 | | 0.01 | 0.01 | 0.1 | | 0.13 | I |
| I | B-A | 3.81 | 8.08 | 0.471 | | 1.65 | 0.92 | 14.6 | | 0.24 | I |
| I | C-AB | 0.30 | 8.33 | 0.036 | | 0.05 | 0.04 | 0.6 | | 0.12 | I |
| I | A-B | 5.63 | | | | | | | | | I |
| I | A-C | 4.30 | | | | | | | | | I |

| I | TIME | DEMAND (VEH/MIN) | CAPACITY (VEH/MIN) | DEMAND/ CAPACITY (RFC) | PEDESTRIAN FLOW (PEDS/MIN) | START QUEUE (VEHS) | END QUEUE (VEHS) | DELAY (VEH.MIN/ TIME SEGMENT) | GEOMETRIC DELAY (VEH.MIN/ TIME SEGMENT) | AVERAGE DELAY PER ARRIVING VEHICLE (MIN) | I |
|---|-------------|---------------------|-----------------------|------------------------------|----------------------------------|--------------------------|------------------------|-------------------------------------|---|--|---|
| I | 09.00-09.15 | | | | | | | | | | I |
| I | B-C | 0.05 | 8.92 | 0.006 | | 0.01 | 0.01 | 0.1 | | 0.11 | I |
| I | B-A | 3.19 | 8.56 | 0.372 | | 0.92 | 0.60 | 9.5 | | 0.19 | I |
| I | C-AB | 0.25 | 8.74 | 0.029 | | 0.04 | 0.03 | 0.5 | | 0.12 | I |
| I | A-B | 4.72 | | | | | | | | | I |
| I | A-C | 3.60 | | | | | | | | | I |

QUEUE FOR STREAM B-C

| TIME SEGMENT ENDING | NO. OF VEHICLES IN QUEUE |
|------------------------|--------------------------------|
| 08.00 | 0.0 |
| 08.15 | 0.0 |
| 08.30 | 0.0 |
| 08.45 | 0.0 |
| 09.00 | 0.0 |
| 09.15 | 0.0 |

QUEUE FOR STREAM B-A

| TIME SEGMENT ENDING | NO. OF VEHICLES IN QUEUE | |
|------------------------|--------------------------------|----|
| 08.00 | 0.6 | * |
| 08.15 | 0.9 | * |
| 08.30 | 1.6 | ** |
| 08.45 | 1.6 | ** |
| 09.00 | 0.9 | * |
| 09.15 | 0.6 | * |

QUEUE FOR STREAM C-AB

| TIME SEGMENT ENDING | NO. OF VEHICLES IN QUEUE |
|---------------------|--------------------------|
| 08.00 | 0.0 |
| 08.15 | 0.0 |
| 08.30 | 0.1 |
| 08.45 | 0.1 |
| 09.00 | 0.0 |
| 09.15 | 0.0 |

QUEUEING DELAY INFORMATION OVER WHOLE PERIOD

| I | STREAM | I | TOTAL DEMAND | I | * QUEUEING * | I | * INCLUSIVE QUEUEING * | I | | |
|---|--------|-----------|--------------|-------|--------------|-----------|------------------------|-----------|------|---|
| I | I | I | I | I | * DELAY * | I | * DELAY * | I | | |
| I | I | (VEH) | (VEH/H) | I | (MIN) | (MIN/VEH) | I | (MIN) | | |
| I | I | (MIN/VEH) | I | (MIN) | (MIN/VEH) | I | (MIN) | (MIN/VEH) | | |
| I | B-C | I | 5.5 | I | 3.7 | I | 0.8 | I | 0.14 | I |
| I | B-A | I | 349.6 | I | 233.1 | I | 91.2 | I | 0.26 | I |
| I | C-AB | I | 27.5 | I | 18.4 | I | 3.6 | I | 0.13 | I |
| I | A-B | I | 517.5 | I | 345.0 | I | | I | | I |
| I | A-C | I | 395.0 | I | 263.4 | I | | I | | I |
| I | ALL | I | 1709.5 | I | 1139.7 | I | 95.5 | I | 0.06 | I |

* DELAY IS THAT OCCURRING ONLY WITHIN THE TIME PERIOD .
 * INCLUSIVE DELAY INCLUDES DELAY SUFFERED BY VEHICLES WHICH ARE STILL QUEUEING AFTER THE END OF THE TIME PERIOD.
 * THESE WILL ONLY BE SIGNIFICANTLY DIFFERENT IF THERE IS A LARGE QUEUE REMAINING AT THE END OF THE TIME PERIOD.

END OF JOB

===== end of file =====

TRL LIMITED

(C) COPYRIGHT 2006

CAPACITIES, QUEUES, AND DELAYS AT 3 OR 4-ARM MAJOR/MINOR PRIORITY JUNCTIONS

PICADY 5.0 ANALYSIS PROGRAM
RELEASE 3.0 (JUNE 2006)

ADAPTED FROM PICADY/3 WHICH IS CROWN COPYRIGHT
BY PERMISSION OF THE CONTROLLER OF HMSO

FOR SALES AND DISTRIBUTION INFORMATION,
PROGRAM ADVICE AND MAINTENANCE CONTACT:
TRL SOFTWARE BUREAU
TEL: CROWTHORNE (01344) 770758, FAX: 770864
EMAIL: SoftwareBureau@trl.co.uk

THE USER OF THIS COMPUTER PROGRAM FOR THE SOLUTION OF AN ENGINEERING PROBLEM IS
IN NO WAY RELIEVED OF HIS RESPONSIBILITY FOR THE CORRECTNESS OF THE SOLUTION

Run with file:-

"J:\120000\120669-00\4 Internal Project Data\4-04 Calculations\4-04-06 Junction Analysis\Picady\
Site 10. Camp Rd - B430 to Ardley\Sensitivity Test\AM\
Site 10. Camp Rd - Unnamed Rd 2013 Base + Full Development ST AM.vpi"
(drive-on-the-left) at 11:07:34 on Friday, 3 August 2007

RUN INFORMATION

RUN TITLE: Site 10. Camp Road - Unnamed Rd towards B430 2013 Base + Full Development ST AM
LOCATION: Oxfordshire
DATE: 31/07/07
CLIENT: North Oxfordshire Consortium
ENUMERATOR: Ian Clarke
JOB NUMBER: 120669
STATUS: TIA

DESCRIPTION:

.MAJOR/MINOR JUNCTION CAPACITY AND DELAY

INPUT DATA

MAJOR ROAD (ARM C) ----- MAJOR ROAD (ARM A)
I
I
I
I
I
I
MINOR ROAD (ARM B)

ARM A IS Camp Rd (W)
ARM B IS Unnamed Rd (E) towards B430
ARM C IS Unnamed Rd (S) towards Middleton Stoney

STREAM LABELLING CONVENTION

STREAM A-B CONTAINS TRAFFIC GOING FROM ARM A TO ARM B
STREAM B-AC CONTAINS TRAFFIC GOING FROM ARM B TO ARM A AND TO ARM C
ETC.

 GEOMETRIC DATA

| I | DATA ITEM | I | MINOR ROAD B | I |
|---|------------------------------------|---|-----------------|---|
| I | TOTAL MAJOR ROAD CARRIAGEWAY WIDTH | I | (W) 6.10 M. | I |
| I | CENTRAL RESERVE WIDTH | I | (WCR) 0.00 M. | I |
| I | | I | | I |
| I | MAJOR ROAD RIGHT TURN - WIDTH | I | (WC-B) 2.20 M. | I |
| I | - VISIBILITY | I | (VC-B) 130.0 M. | I |
| I | - BLOCKS TRAFFIC | I | YES | I |
| I | | I | | I |
| I | MINOR ROAD - VISIBILITY TO LEFT | I | (VB-C) 120.0 M. | I |
| I | - VISIBILITY TO RIGHT | I | (VB-A) 145.0 M. | I |
| I | - LANE 1 WIDTH | I | (WB-C) - | I |
| I | - LANE 2 WIDTH | I | (WB-A) - | I |
| I | - WIDTH AT 0 M FROM JUNC. | I | 10.00 M. | I |
| I | - WIDTH AT 5 M FROM JUNC. | I | 6.00 M. | I |
| I | - WIDTH AT 10 M FROM JUNC. | I | 4.30 M. | I |
| I | - WIDTH AT 15 M FROM JUNC. | I | 3.40 M. | I |
| I | - WIDTH AT 20 M FROM JUNC. | I | 3.40 M. | I |
| I | - LENGTH OF FLARED SECTION | I | 1 VEHS | I |

 .SLOPES AND INTERCEPT

(NB:Streams may be combined, in which case capacity will be adjusted)

| I | Intercept For Stream B-C | Slope For Stream A-C | Slope For Opposing Stream A-B | I |
|---|--------------------------|----------------------|-------------------------------|---|
| I | 657.93 | 0.25 | 0.10 | I |

| I | Intercept For Stream B-A | Slope For Stream A-C | Slope For Opposing Stream A-B | Slope For Opposing Stream C-A | Slope For Opposing Stream C-B | I |
|---|--------------------------|----------------------|-------------------------------|-------------------------------|-------------------------------|---|
| I | 543.76 | 0.25 | 0.10 | 0.16 | 0.36 | I |

| I | Intercept For Stream C-B | Slope For Stream A-C | Slope For Opposing Stream A-B | I |
|---|--------------------------|----------------------|-------------------------------|---|
| I | 649.25 | 0.25 | 0.25 | I |

NB These values do not allow for any site specific corrections

 TRAFFIC DEMAND DATA

| I | TIME | DEMAND (VEH/MIN) | CAPACITY (VEH/MIN) | DEMAND/ CAPACITY (RFC) | PEDESTRIAN FLOW (PEDS/MIN) | START QUEUE (VEHS) | END QUEUE (VEHS) | DELAY (VEH.MIN/ TIME SEGMENT) | GEOMETRIC DELAY (VEH.MIN/ TIME SEGMENT) | AVERAGE DELAY PER ARRIVING VEHICLE (MIN) | I |
|---|-------------|---------------------|-----------------------|------------------------------|----------------------------------|--------------------------|------------------------|-------------------------------------|---|--|---|
| I | 08.15-08.30 | | | | | | | | | | I |
| I | B-C | 0.39 | 0.37 | 1.034 | | 0.08 | 2.05 | 18.9 | | 6.07 | I |
| I | B-A | 8.31 | 8.13 | 1.022 | | 3.16 | 12.73 | 130.0 | | 1.36 | I |
| I | C-AB | 0.17 | 7.84 | 0.021 | | 0.02 | 0.02 | 0.3 | | 0.13 | I |
| I | A-B | 7.38 | | | | | | | | | I |
| I | A-C | 4.53 | | | | | | | | | I |

| I | TIME | DEMAND (VEH/MIN) | CAPACITY (VEH/MIN) | DEMAND/ CAPACITY (RFC) | PEDESTRIAN FLOW (PEDS/MIN) | START QUEUE (VEHS) | END QUEUE (VEHS) | DELAY (VEH.MIN/ TIME SEGMENT) | GEOMETRIC DELAY (VEH.MIN/ TIME SEGMENT) | AVERAGE DELAY PER ARRIVING VEHICLE (MIN) | I |
|---|-------------|---------------------|-----------------------|------------------------------|----------------------------------|--------------------------|------------------------|-------------------------------------|---|--|---|
| I | 08.30-08.45 | | | | | | | | | | I |
| I | B-C | 0.39 | 0.46 | 0.832 | | 2.05 | 2.44 | 33.9 | | 6.12 | I |
| I | B-A | 8.31 | 8.12 | 1.023 | | 12.73 | 18.79 | 238.2 | | 2.26 | I |
| I | C-AB | 0.17 | 7.84 | 0.021 | | 0.02 | 0.02 | 0.3 | | 0.13 | I |
| I | A-B | 7.38 | | | | | | | | | I |
| I | A-C | 4.53 | | | | | | | | | I |

| I | TIME | DEMAND (VEH/MIN) | CAPACITY (VEH/MIN) | DEMAND/ CAPACITY (RFC) | PEDESTRIAN FLOW (PEDS/MIN) | START QUEUE (VEHS) | END QUEUE (VEHS) | DELAY (VEH.MIN/ TIME SEGMENT) | GEOMETRIC DELAY (VEH.MIN/ TIME SEGMENT) | AVERAGE DELAY PER ARRIVING VEHICLE (MIN) | I |
|---|-------------|---------------------|-----------------------|------------------------------|----------------------------------|--------------------------|------------------------|-------------------------------------|---|--|---|
| I | 08.45-09.00 | | | | | | | | | | I |
| I | B-C | 0.31 | 1.96 | 0.160 | | 2.44 | 0.20 | 5.6 | | 0.73 | I |
| I | B-A | 6.79 | 8.66 | 0.784 | | 18.79 | 4.45 | 140.1 | | 1.32 | I |
| I | C-AB | 0.13 | 8.39 | 0.016 | | 0.02 | 0.02 | 0.2 | | 0.12 | I |
| I | A-B | 6.02 | | | | | | | | | I |
| I | A-C | 3.70 | | | | | | | | | I |

| I | TIME | DEMAND (VEH/MIN) | CAPACITY (VEH/MIN) | DEMAND/ CAPACITY (RFC) | PEDESTRIAN FLOW (PEDS/MIN) | START QUEUE (VEHS) | END QUEUE (VEHS) | DELAY (VEH.MIN/ TIME SEGMENT) | GEOMETRIC DELAY (VEH.MIN/ TIME SEGMENT) | AVERAGE DELAY PER ARRIVING VEHICLE (MIN) | I |
|---|-------------|---------------------|-----------------------|------------------------------|----------------------------------|--------------------------|------------------------|-------------------------------------|---|--|---|
| I | 09.00-09.15 | | | | | | | | | | I |
| I | B-C | 0.26 | 6.37 | 0.041 | | 0.20 | 0.04 | 0.7 | | 0.16 | I |
| I | B-A | 5.68 | 9.06 | 0.627 | | 4.45 | 1.77 | 30.2 | | 0.33 | I |
| I | C-AB | 0.11 | 8.78 | 0.013 | | 0.02 | 0.01 | 0.2 | | 0.12 | I |
| I | A-B | 5.04 | | | | | | | | | I |
| I | A-C | 3.10 | | | | | | | | | I |

QUEUE FOR STREAM B-C

| TIME SEGMENT ENDING | NO. OF VEHICLES IN QUEUE |
|------------------------|--------------------------------|
| 08.00 | 0.0 |
| 08.15 | 0.1 |
| 08.30 | 2.1 ** |
| 08.45 | 2.4 ** |
| 09.00 | 0.2 |
| 09.15 | 0.0 |

QUEUE FOR STREAM B-A

| TIME SEGMENT ENDING | NO. OF VEHICLES IN QUEUE |
|------------------------|--------------------------------|
| 08.00 | 1.6 ** |
| 08.15 | 3.2 *** |
| 08.30 | 12.7 ***** |
| 08.45 | 18.8 ***** |
| 09.00 | 4.5 **** |
| 09.15 | 1.8 ** |

QUEUE FOR STREAM C-AB

| TIME SEGMENT ENDING | NO. OF VEHICLES IN QUEUE |
|---------------------|--------------------------|
| 08.00 | 0.0 |
| 08.15 | 0.0 |
| 08.30 | 0.0 |
| 08.45 | 0.0 |
| 09.00 | 0.0 |
| 09.15 | 0.0 |

QUEUEING DELAY INFORMATION OVER WHOLE PERIOD

| I | STREAM | I | TOTAL DEMAND | I | * QUEUEING * * DELAY * | I | * INCLUSIVE QUEUEING * * DELAY * | I | | |
|---|--------|-------|--------------|---|---------------------------|-----------|-------------------------------------|-------|-----------|---|
| I | I | I | I | I | I | I | I | I | | |
| I | I | I | I | I | I | I | I | I | | |
| I | I | (VEH) | (VEH/H) | I | (MIN) | (MIN/VEH) | I | (MIN) | (MIN/VEH) | I |
| I | B-C | I | 28.9 | I | 19.3 | I | 60.7 | I | 2.10 | I |
| I | B-A | I | 623.5 | I | 415.7 | I | 601.6 | I | 0.96 | I |
| I | C-AB | I | 12.4 | I | 8.3 | I | 1.5 | I | 0.12 | I |
| I | A-B | I | 553.3 | I | 368.9 | I | | I | | I |
| I | A-C | I | 340.0 | I | 226.7 | I | | I | | I |
| I | ALL | I | 1779.7 | I | 1186.5 | I | 663.9 | I | 0.37 | I |

* DELAY IS THAT OCCURRING ONLY WITHIN THE TIME PERIOD .
 * INCLUSIVE DELAY INCLUDES DELAY SUFFERED BY VEHICLES WHICH ARE STILL QUEUEING AFTER THE END OF THE TIME PERIOD.
 * THESE WILL ONLY BE SIGNIFICANTLY DIFFERENT IF THERE IS A LARGE QUEUE REMAINING AT THE END OF THE TIME PERIOD.

END OF JOB

===== end of file =====

TRL LIMITED

(C) COPYRIGHT 2006

CAPACITIES, QUEUES, AND DELAYS AT 3 OR 4-ARM MAJOR/MINOR PRIORITY JUNCTIONS

PICADY 5.0 ANALYSIS PROGRAM
RELEASE 3.0 (JUNE 2006)

ADAPTED FROM PICADY/3 WHICH IS CROWN COPYRIGHT
BY PERMISSION OF THE CONTROLLER OF HMSO

FOR SALES AND DISTRIBUTION INFORMATION,
PROGRAM ADVICE AND MAINTENANCE CONTACT:
TRL SOFTWARE BUREAU
TEL: CROWTHORNE (01344) 770758, FAX: 770864
EMAIL: SoftwareBureau@trl.co.uk

THE USER OF THIS COMPUTER PROGRAM FOR THE SOLUTION OF AN ENGINEERING PROBLEM IS
IN NO WAY RELIEVED OF HIS RESPONSIBILITY FOR THE CORRECTNESS OF THE SOLUTION

Run with file:-

"J:\120000\120669-00\4 Internal Project Data\4-04 Calculations\4-04-06 Junction Analysis\Picady\
Site 10. Camp Rd - B430 to Ardley\Sensitivity Test\PM\
Site 10. Camp Rd - Unnamed Rd 2013 Base + Full Development ST PM.vpi"
(drive-on-the-left) at 11:03:53 on Friday, 3 August 2007

RUN INFORMATION

RUN TITLE: Site 10. Camp Road - Unnamed Rd towards B430 2013 Base + Full Development ST PM
LOCATION: Oxfordshire
DATE: 31/07/07
CLIENT: North Oxfordshire Consortium
ENUMERATOR: Ian Clarke
JOB NUMBER: 120669
STATUS: TIA
DESCRIPTION:

.MAJOR/MINOR JUNCTION CAPACITY AND DELAY

INPUT DATA

MAJOR ROAD (ARM C) ----- MAJOR ROAD (ARM A)
I
I
I
I
I
I
MINOR ROAD (ARM B)

ARM A IS Camp Rd (W)
ARM B IS Unnamed Rd (E) towards B430
ARM C IS Unnamed Rd (S) towards Middleton Stoney

STREAM LABELLING CONVENTION

STREAM A-B CONTAINS TRAFFIC GOING FROM ARM A TO ARM B
STREAM B-AC CONTAINS TRAFFIC GOING FROM ARM B TO ARM A AND TO ARM C
ETC.

 GEOMETRIC DATA

| DATA ITEM | MINOR ROAD B |
|------------------------------------|-----------------|
| TOTAL MAJOR ROAD CARRIAGEWAY WIDTH | (W) 6.10 M. |
| CENTRAL RESERVE WIDTH | (WCR) 0.00 M. |
| MAJOR ROAD RIGHT TURN - WIDTH | (WC-B) 2.20 M. |
| - VISIBILITY | (VC-B) 130.0 M. |
| - BLOCKS TRAFFIC | YES |
| MINOR ROAD - VISIBILITY TO LEFT | (VB-C) 120.0 M. |
| - VISIBILITY TO RIGHT | (VB-A) 145.0 M. |
| - LANE 1 WIDTH | (WB-C) - |
| - LANE 2 WIDTH | (WB-A) - |
| - WIDTH AT 0 M FROM JUNC. | 10.00 M. |
| - WIDTH AT 5 M FROM JUNC. | 6.00 M. |
| - WIDTH AT 10 M FROM JUNC. | 4.30 M. |
| - WIDTH AT 15 M FROM JUNC. | 3.40 M. |
| - WIDTH AT 20 M FROM JUNC. | 3.40 M. |
| - LENGTH OF FLARED SECTION | 1 VEHS |

.SLOPES AND INTERCEPT

(NB:Streams may be combined, in which case capacity will be adjusted)

| Intercept For Stream B-C | Slope For Opposing Stream A-C | Slope For Opposing Stream A-B |
|--------------------------|-------------------------------|-------------------------------|
| 657.93 | 0.25 | 0.10 |

| Intercept For Stream B-A | Slope For Opposing Stream A-C | Slope For Opposing Stream A-B | Slope For Opposing Stream C-A | Slope For Opposing Stream C-B |
|--------------------------|-------------------------------|-------------------------------|-------------------------------|-------------------------------|
| 543.76 | 0.25 | 0.10 | 0.16 | 0.36 |

| Intercept For Stream C-B | Slope For Opposing Stream A-C | Slope For Opposing Stream A-B |
|--------------------------|-------------------------------|-------------------------------|
| 649.25 | 0.25 | 0.25 |

NB These values do not allow for any site specific corrections

 TRAFFIC DEMAND DATA

| I | TIME | DEMAND (VEH/MIN) | CAPACITY (VEH/MIN) | DEMAND/ CAPACITY (RFC) | PEDESTRIAN FLOW (PEDS/MIN) | START QUEUE (VEHS) | END QUEUE (VEHS) | DELAY (VEH.MIN/ TIME SEGMENT) | GEOMETRIC DELAY (VEH.MIN/ TIME SEGMENT) | AVERAGE DELAY PER ARRIVING VEHICLE (MIN) | I |
|---|-------------|---------------------|-----------------------|------------------------------|----------------------------------|--------------------------|------------------------|-------------------------------------|---|--|---|
| I | 17.15-17.30 | | | | | | | | | | I |
| I | B-C | 0.07 | 3.72 | 0.020 | | 0.01 | 0.02 | 0.3 | | 0.27 | I |
| I | B-A | 6.46 | 8.06 | 0.801 | | 1.51 | 3.44 | 44.1 | | 0.54 | I |
| I | C-AB | 0.37 | 7.78 | 0.047 | | 0.04 | 0.05 | 0.8 | | 0.13 | I |
| I | A-B | 8.55 | | | | | | | | | I |
| I | A-C | 3.60 | | | | | | | | | I |

| I | TIME | DEMAND (VEH/MIN) | CAPACITY (VEH/MIN) | DEMAND/ CAPACITY (RFC) | PEDESTRIAN FLOW (PEDS/MIN) | START QUEUE (VEHS) | END QUEUE (VEHS) | DELAY (VEH.MIN/ TIME SEGMENT) | GEOMETRIC DELAY (VEH.MIN/ TIME SEGMENT) | AVERAGE DELAY PER ARRIVING VEHICLE (MIN) | I |
|---|-------------|---------------------|-----------------------|------------------------------|----------------------------------|--------------------------|------------------------|-------------------------------------|---|--|---|
| I | 17.30-17.45 | | | | | | | | | | I |
| I | B-C | 0.07 | 3.44 | 0.021 | | 0.02 | 0.02 | 0.3 | | 0.30 | I |
| I | B-A | 6.46 | 8.06 | 0.802 | | 3.44 | 3.69 | 53.8 | | 0.60 | I |
| I | C-AB | 0.37 | 7.78 | 0.047 | | 0.05 | 0.05 | 0.8 | | 0.13 | I |
| I | A-B | 8.55 | | | | | | | | | I |
| I | A-C | 3.60 | | | | | | | | | I |

| I | TIME | DEMAND (VEH/MIN) | CAPACITY (VEH/MIN) | DEMAND/ CAPACITY (RFC) | PEDESTRIAN FLOW (PEDS/MIN) | START QUEUE (VEHS) | END QUEUE (VEHS) | DELAY (VEH.MIN/ TIME SEGMENT) | GEOMETRIC DELAY (VEH.MIN/ TIME SEGMENT) | AVERAGE DELAY PER ARRIVING VEHICLE (MIN) | I |
|---|-------------|---------------------|-----------------------|------------------------------|----------------------------------|--------------------------|------------------------|-------------------------------------|---|--|---|
| I | 17.45-18.00 | | | | | | | | | | I |
| I | B-C | 0.06 | 6.42 | 0.009 | | 0.02 | 0.01 | 0.1 | | 0.16 | I |
| I | B-A | 5.27 | 8.61 | 0.613 | | 3.69 | 1.66 | 27.7 | | 0.32 | I |
| I | C-AB | 0.30 | 8.34 | 0.036 | | 0.05 | 0.04 | 0.6 | | 0.12 | I |
| I | A-B | 6.98 | | | | | | | | | I |
| I | A-C | 2.94 | | | | | | | | | I |

| I | TIME | DEMAND (VEH/MIN) | CAPACITY (VEH/MIN) | DEMAND/ CAPACITY (RFC) | PEDESTRIAN FLOW (PEDS/MIN) | START QUEUE (VEHS) | END QUEUE (VEHS) | DELAY (VEH.MIN/ TIME SEGMENT) | GEOMETRIC DELAY (VEH.MIN/ TIME SEGMENT) | AVERAGE DELAY PER ARRIVING VEHICLE (MIN) | I |
|---|-------------|---------------------|-----------------------|------------------------------|----------------------------------|--------------------------|------------------------|-------------------------------------|---|--|---|
| I | 18.00-18.15 | | | | | | | | | | I |
| I | B-C | 0.05 | 8.11 | 0.006 | | 0.01 | 0.01 | 0.1 | | 0.12 | I |
| I | B-A | 4.42 | 9.01 | 0.490 | | 1.66 | 0.99 | 15.7 | | 0.22 | I |
| I | C-AB | 0.25 | 8.74 | 0.029 | | 0.04 | 0.03 | 0.4 | | 0.12 | I |
| I | A-B | 5.85 | | | | | | | | | I |
| I | A-C | 2.46 | | | | | | | | | I |

QUEUE FOR STREAM B-C

| TIME SEGMENT ENDING | NO. OF VEHICLES IN QUEUE |
|------------------------|--------------------------------|
| 17.00 | 0.0 |
| 17.15 | 0.0 |
| 17.30 | 0.0 |
| 17.45 | 0.0 |
| 18.00 | 0.0 |
| 18.15 | 0.0 |

QUEUE FOR STREAM B-A

| TIME SEGMENT ENDING | NO. OF VEHICLES IN QUEUE |
|------------------------|--------------------------------|
| 17.00 | 0.9 * |
| 17.15 | 1.5 ** |
| 17.30 | 3.4 *** |
| 17.45 | 3.7 **** |
| 18.00 | 1.7 ** |
| 18.15 | 1.0 * |

QUEUE FOR STREAM C-AB

| TIME SEGMENT ENDING | NO. OF VEHICLES IN QUEUE |
|---------------------|--------------------------|
| 17.00 | 0.0 |
| 17.15 | 0.0 |
| 17.30 | 0.1 |
| 17.45 | 0.1 |
| 18.00 | 0.0 |
| 18.15 | 0.0 |

QUEUEING DELAY INFORMATION OVER WHOLE PERIOD

| I STREAM I | TOTAL DEMAND I | | * QUEUEING * I | | * INCLUSIVE QUEUEING * I | |
|------------|----------------|---------|----------------|-----------|--------------------------|-----------|
| | (VEH) | (VEH/H) | (MIN) | (MIN/VEH) | (MIN) | (MIN/VEH) |
| I B-C I | 5.5 | 3.7 | 1.1 | 0.19 | 1.1 | 0.19 |
| I B-A I | 484.5 | 323.0 | 175.5 | 0.36 | 175.5 | 0.36 |
| I C-AB I | 27.5 | 18.4 | 3.5 | 0.13 | 3.5 | 0.13 |
| I A-B I | 641.4 | 427.6 | | | | |
| I A-C I | 269.8 | 179.9 | | | | |
| I ALL I | 1708.1 | 1138.8 | 180.1 | 0.11 | 180.1 | 0.11 |

* DELAY IS THAT OCCURRING ONLY WITHIN THE TIME PERIOD .

* INCLUSIVE DELAY INCLUDES DELAY SUFFERED BY VEHICLES WHICH ARE STILL QUEUEING AFTER THE END OF THE TIME PERIOD.

* THESE WILL ONLY BE SIGNIFICANTLY DIFFERENT IF THERE IS A LARGE QUEUE REMAINING AT THE END OF THE TIME PERIOD.

END OF JOB

===== end of file =====

TRL LIMITED

(C) COPYRIGHT 2006

CAPACITIES, QUEUES, AND DELAYS AT 3 OR 4-ARM MAJOR/MINOR PRIORITY JUNCTIONS

PICADY 5.0 ANALYSIS PROGRAM
RELEASE 3.0 (JUNE 2006)

ADAPTED FROM PICADY/3 WHICH IS CROWN COPYRIGHT
BY PERMISSION OF THE CONTROLLER OF HMSO

FOR SALES AND DISTRIBUTION INFORMATION,
PROGRAM ADVICE AND MAINTENANCE CONTACT:
TRL SOFTWARE BUREAU
TEL: CROWTHORNE (01344) 770758, FAX: 770864
EMAIL: SoftwareBureau@trl.co.uk

THE USER OF THIS COMPUTER PROGRAM FOR THE SOLUTION OF AN ENGINEERING PROBLEM IS
IN NO WAY RELIEVED OF HIS RESPONSIBILITY FOR THE CORRECTNESS OF THE SOLUTION

Run with file:-
"J:\120000\120669-00\4 Internal Project Data\4-04 Calculations\4-04-06 Junction Analysis\Picady\
Site 11. Camp Rd - Kirtlington Rd\2006 base\AM\Site 11.Camp Rd - Kirtlington Rd 2006 Base AM.vpi"
(drive-on-the-left) at 10:03:33 on Wednesday, 8 August 2007

RUN INFORMATION

RUN TITLE: Site 11. Camp Rd - Kirtlington Rd 2006 Base AM
LOCATION: Oxfordshire
DATE: 09/11/06
CLIENT: North Oxfordshire Consortium
ENUMERATOR: Chris.Morris [MCCPC062011]
JOB NUMBER: 120669
STATUS: TIA
DESCRIPTION:

.MAJOR/MINOR JUNCTION CAPACITY AND DELAY

INPUT DATA

MAJOR ROAD (ARM C) ----- MAJOR ROAD (ARM A)
I
I
I
I
I
I
MINOR ROAD (ARM B)

ARM A IS Camp Road (E)
ARM B IS Kirtlington Rd
ARM C IS Camp Road (W)

STREAM LABELLING CONVENTION

STREAM A-B CONTAINS TRAFFIC GOING FROM ARM A TO ARM B
STREAM B-AC CONTAINS TRAFFIC GOING FROM ARM B TO ARM A AND TO ARM C
ETC.

 GEOMETRIC DATA

| I | DATA ITEM | I | MINOR ROAD B | I |
|---|------------------------------------|----------|--------------|---|
| I | TOTAL MAJOR ROAD CARRIAGEWAY WIDTH | I (W) | 6.00 M. | I |
| I | CENTRAL RESERVE WIDTH | I (WCR) | 0.00 M. | I |
| I | | I | | I |
| I | MAJOR ROAD RIGHT TURN - WIDTH | I (WC-B) | 2.20 M. | I |
| I | - VISIBILITY | I (VC-B) | 95.0 M. | I |
| I | - BLOCKS TRAFFIC | I | YES | I |
| I | | I | | I |
| I | MINOR ROAD - VISIBILITY TO LEFT | I (VB-C) | 21.0 M. | I |
| I | - VISIBILITY TO RIGHT | I (VB-A) | 16.0 M. | I |
| I | - LANE 1 WIDTH | I (WB-C) | 2.50 M. | I |
| I | - LANE 2 WIDTH | I (WB-A) | 0.00 M. | I |

.SLOPES AND INTERCEPT

(NB:Streams may be combined, in which case capacity will be adjusted)

| I | Intercept For Stream B-C | Slope For Stream A-C | Slope For Opposing Stream A-B | I |
|---|--------------------------|----------------------|-------------------------------|---|
| I | 602.27 | 0.23 | 0.09 | I |

| I | Intercept For Stream B-A | Slope For Stream A-C | Slope For Opposing Stream A-B | Slope For Opposing Stream C-A | Slope For Opposing Stream C-B | I |
|---|--------------------------|----------------------|-------------------------------|-------------------------------|-------------------------------|---|
| I | 467.65 | 0.22 | 0.09 | 0.14 | 0.31 | I |

| I | Intercept For Stream C-B | Slope For Stream A-C | Slope For Opposing Stream A-B | I |
|---|--------------------------|----------------------|-------------------------------|---|
| I | 628.98 | 0.24 | 0.24 | I |

NB These values do not allow for any site specific corrections

TRAFFIC DEMAND DATA

| I | ARM | I | FLOW SCALE(%) | I |
|---|-----|---|---------------|---|
| I | A | I | 100 | I |
| I | B | I | 100 | I |
| I | C | I | 100 | I |

Demand set: Site 11. Camp Rd - Kirtlington Rd 2006 base AM

TIME PERIOD BEGINS 07.45 AND ENDS 09.15

LENGTH OF TIME PERIOD - 90 MINUTES.
 LENGTH OF TIME SEGMENT - 15 MINUTES.

DEMAND FLOW PROFILES ARE SYNTHESISED FROM TURNING COUNT DATA

| I | ARM | I | NUMBER OF MINUTES FROM START WHEN FLOW STARTS TO RISE | I | TOP OF PEAK IS REACHED | I | FLOW STOPS FALLING | I | RATE OF FLOW (VEH/MIN) BEFORE PEAK | I | AT TOP OF PEAK | I | AFTER PEAK | I |
|---|-------|---|---|---|------------------------|---|--------------------|---|------------------------------------|---|----------------|---|------------|---|
| I | ARM A | I | 15.00 | I | 45.00 | I | 75.00 | I | 0.70 | I | 1.05 | I | 0.70 | I |
| I | ARM B | I | 15.00 | I | 45.00 | I | 75.00 | I | 0.04 | I | 0.06 | I | 0.04 | I |
| I | ARM C | I | 15.00 | I | 45.00 | I | 75.00 | I | 0.69 | I | 1.03 | I | 0.69 | I |

| I | TIME | DEMAND (VEH/MIN) | CAPACITY (VEH/MIN) | DEMAND/ CAPACITY (RFC) | PEDESTRIAN FLOW (PEDS/MIN) | START QUEUE (VEHS) | END QUEUE (VEHS) | DELAY (VEH.MIN/ TIME SEGMENT) | GEOMETRIC DELAY (VEH.MIN/ TIME SEGMENT) | AVERAGE DELAY PER ARRIVING VEHICLE (MIN) | I |
|---|-------------|---------------------|-----------------------|------------------------------|----------------------------------|--------------------------|------------------------|-------------------------------------|---|--|---|
| I | 08.45-09.00 | | | | | | | | | | I |
| I | B-AC | 0.04 | 8.91 | 0.005 | | 0.01 | 0.01 | 0.1 | | 0.11 | I |
| I | C-AB | 0.22 | 10.28 | 0.022 | | 0.03 | 0.02 | 0.3 | | 0.10 | I |
| I | A-B | 0.12 | | | | | | | | | I |
| I | A-C | 0.72 | | | | | | | | | I |

| I | TIME | DEMAND (VEH/MIN) | CAPACITY (VEH/MIN) | DEMAND/ CAPACITY (RFC) | PEDESTRIAN FLOW (PEDS/MIN) | START QUEUE (VEHS) | END QUEUE (VEHS) | DELAY (VEH.MIN/ TIME SEGMENT) | GEOMETRIC DELAY (VEH.MIN/ TIME SEGMENT) | AVERAGE DELAY PER ARRIVING VEHICLE (MIN) | I |
|---|-------------|---------------------|-----------------------|------------------------------|----------------------------------|--------------------------|------------------------|-------------------------------------|---|--|---|
| I | 09.00-09.15 | | | | | | | | | | I |
| I | B-AC | 0.04 | 8.95 | 0.004 | | 0.01 | 0.00 | 0.1 | | 0.11 | I |
| I | C-AB | 0.19 | 10.31 | 0.018 | | 0.02 | 0.02 | 0.3 | | 0.10 | I |
| I | A-B | 0.10 | | | | | | | | | I |
| I | A-C | 0.60 | | | | | | | | | I |

QUEUE FOR STREAM B-AC

| TIME SEGMENT ENDING | NO. OF VEHICLES IN QUEUE |
|------------------------|--------------------------------|
| 08.00 | 0.0 |
| 08.15 | 0.0 |
| 08.30 | 0.0 |
| 08.45 | 0.0 |
| 09.00 | 0.0 |
| 09.15 | 0.0 |

QUEUE FOR STREAM C-AB

| TIME SEGMENT ENDING | NO. OF VEHICLES IN QUEUE |
|------------------------|--------------------------------|
| 08.00 | 0.0 |
| 08.15 | 0.0 |
| 08.30 | 0.0 |
| 08.45 | 0.0 |
| 09.00 | 0.0 |
| 09.15 | 0.0 |

QUEUEING DELAY INFORMATION OVER WHOLE PERIOD

| I | STREAM | I | TOTAL DEMAND | I | * QUEUEING * | I | * INCLUSIVE QUEUEING * | I | * DELAY * | I |
|---|--------|---|--------------|---|--------------|---|------------------------|---|-----------|---|
| I | I | I | (VEH) | I | (MIN) | I | (MIN) | I | (MIN/VEH) | I |
| I | B-AC | I | 4.1 | I | 2.8 | I | 0.5 | I | 0.11 | I |
| I | C-AB | I | 20.6 | I | 13.8 | I | 2.1 | I | 0.10 | I |
| I | A-B | I | 11.0 | I | 7.3 | I | | I | | I |
| I | A-C | I | 66.1 | I | 44.0 | I | | I | | I |
| I | ALL | I | 156.9 | I | 104.6 | I | 2.5 | I | 0.02 | I |

- * DELAY IS THAT OCCURRING ONLY WITHIN THE TIME PERIOD .
- * INCLUSIVE DELAY INCLUDES DELAY SUFFERED BY VEHICLES WHICH ARE STILL QUEUEING AFTER THE END OF THE TIME PERIOD.
- * THESE WILL ONLY BE SIGNIFICANTLY DIFFERENT IF THERE IS A LARGE QUEUE REMAINING AT THE END OF THE TIME PERIOD.

END OF JOB

===== end of file =====

TRL LIMITED

(C) COPYRIGHT 2006

CAPACITIES, QUEUES, AND DELAYS AT 3 OR 4-ARM MAJOR/MINOR PRIORITY JUNCTIONS

PICADY 5.0 ANALYSIS PROGRAM
RELEASE 3.0 (JUNE 2006)

ADAPTED FROM PICADY/3 WHICH IS CROWN COPYRIGHT
BY PERMISSION OF THE CONTROLLER OF HMSO

FOR SALES AND DISTRIBUTION INFORMATION,
PROGRAM ADVICE AND MAINTENANCE CONTACT:
TRL SOFTWARE BUREAU
TEL: CROWTHORNE (01344) 770758, FAX: 770864
EMAIL: SoftwareBureau@trl.co.uk

THE USER OF THIS COMPUTER PROGRAM FOR THE SOLUTION OF AN ENGINEERING PROBLEM IS
IN NO WAY RELIEVED OF HIS RESPONSIBILITY FOR THE CORRECTNESS OF THE SOLUTION

Run with file:-
"J:\120000\120669-00\4 Internal Project Data\4-04 Calculations\4-04-06 Junction Analysis\Picady\
Site 11. Camp Rd - Kirtlington Rd\2006 base\PM\Site 11.Camp Rd - Kirtlington Rd 2006 Base PM.vpi"
(drive-on-the-left) at 10:11:07 on Wednesday, 8 August 2007

RUN INFORMATION

RUN TITLE: Site 11. Camp Rd - Kirtlington Rd 2006 Base PM
LOCATION: Oxfordshire
DATE: 09/11/06
CLIENT: North Oxfordshire Consortium
ENUMERATOR: Chris.Morris [MCCPC062011]
JOB NUMBER: 120669
STATUS: TIA
DESCRIPTION:

.MAJOR/MINOR JUNCTION CAPACITY AND DELAY

INPUT DATA

MAJOR ROAD (ARM C) ----- MAJOR ROAD (ARM A)
I
I
I
I
I
I
MINOR ROAD (ARM B)

ARM A IS Camp Road (E)
ARM B IS Kirtlington Rd
ARM C IS Camp Road (W)

STREAM LABELLING CONVENTION

STREAM A-B CONTAINS TRAFFIC GOING FROM ARM A TO ARM B
STREAM B-AC CONTAINS TRAFFIC GOING FROM ARM B TO ARM A AND TO ARM C
ETC.

 GEOMETRIC DATA

| I | DATA ITEM | I | MINOR ROAD B | I |
|---|------------------------------------|----------|--------------|---|
| I | TOTAL MAJOR ROAD CARRIAGEWAY WIDTH | I (W) | 6.00 M. | I |
| I | CENTRAL RESERVE WIDTH | I (WCR) | 0.00 M. | I |
| I | | I | | I |
| I | MAJOR ROAD RIGHT TURN - WIDTH | I (WC-B) | 2.20 M. | I |
| I | - VISIBILITY | I (VC-B) | 95.0 M. | I |
| I | - BLOCKS TRAFFIC | I | YES | I |
| I | | I | | I |
| I | MINOR ROAD - VISIBILITY TO LEFT | I (VB-C) | 21.0 M. | I |
| I | - VISIBILITY TO RIGHT | I (VB-A) | 16.0 M. | I |
| I | - LANE 1 WIDTH | I (WB-C) | 2.50 M. | I |
| I | - LANE 2 WIDTH | I (WB-A) | 0.00 M. | I |

.SLOPES AND INTERCEPT

(NB:Streams may be combined, in which case capacity will be adjusted)

| I | Intercept For Stream B-C | Slope For Stream A-C | Slope For Opposing Stream A-B | I |
|---|--------------------------|----------------------|-------------------------------|---|
| I | 602.27 | 0.23 | 0.09 | I |

| I | Intercept For Stream B-A | Slope For Stream A-C | Slope For Opposing Stream A-B | Slope For Opposing Stream C-A | Slope For Opposing Stream C-B | I |
|---|--------------------------|----------------------|-------------------------------|-------------------------------|-------------------------------|---|
| I | 467.65 | 0.22 | 0.09 | 0.14 | 0.31 | I |

| I | Intercept For Stream C-B | Slope For Stream A-C | Slope For Opposing Stream A-B | I |
|---|--------------------------|----------------------|-------------------------------|---|
| I | 628.98 | 0.24 | 0.24 | I |

NB These values do not allow for any site specific corrections

TRAFFIC DEMAND DATA

| I | ARM | I | FLOW SCALE(%) | I |
|---|-----|---|---------------|---|
| I | A | I | 100 | I |
| I | B | I | 100 | I |
| I | C | I | 100 | I |

Demand set: Site 11. Camp Rd - Kirtlington Rd 2006 Base PM

TIME PERIOD BEGINS 16.45 AND ENDS 18.15

LENGTH OF TIME PERIOD - 90 MINUTES.
 LENGTH OF TIME SEGMENT - 15 MINUTES.

DEMAND FLOW PROFILES ARE SYNTHESISED FROM TURNING COUNT DATA

| I | ARM | I | NUMBER OF MINUTES FROM START WHEN FLOW STARTS TO RISE | I | TOP OF PEAK IS REACHED | I | FLOW STOPS FALLING | I | RATE OF FLOW (VEH/MIN) BEFORE PEAK | I | AT TOP OF PEAK | I | AFTER PEAK |
|---|-------|---|---|---|------------------------|---|--------------------|---|------------------------------------|---|----------------|---|------------|
| I | ARM A | I | 15.00 | I | 45.00 | I | 75.00 | I | 0.29 | I | 0.43 | I | 0.29 |
| I | ARM B | I | 15.00 | I | 45.00 | I | 75.00 | I | 0.74 | I | 1.11 | I | 0.74 |
| I | ARM C | I | 15.00 | I | 45.00 | I | 75.00 | I | 0.59 | I | 0.88 | I | 0.59 |

| I | TIME | DEMAND (VEH/MIN) | CAPACITY (VEH/MIN) | DEMAND/ CAPACITY (RFC) | PEDESTRIAN FLOW (PEDS/MIN) | START QUEUE (VEHS) | END QUEUE (VEHS) | DELAY (VEH.MIN/ TIME SEGMENT) | GEOMETRIC DELAY (VEH.MIN/ TIME SEGMENT) | AVERAGE DELAY PER ARRIVING VEHICLE (MIN) | I |
|---|-------------|---------------------|-----------------------|------------------------------|----------------------------------|--------------------------|------------------------|-------------------------------------|---|--|---|
| I | 17.45-18.00 | | | | | | | | | | I |
| I | B-AC | 0.88 | 9.33 | 0.095 | | 0.13 | 0.11 | 1.6 | | 0.12 | I |
| I | C-AB | 0.07 | 10.40 | 0.007 | | 0.01 | 0.01 | 0.1 | | 0.10 | I |
| I | A-B | 0.04 | | | | | | | | | I |
| I | A-C | 0.30 | | | | | | | | | I |

| I | TIME | DEMAND (VEH/MIN) | CAPACITY (VEH/MIN) | DEMAND/ CAPACITY (RFC) | PEDESTRIAN FLOW (PEDS/MIN) | START QUEUE (VEHS) | END QUEUE (VEHS) | DELAY (VEH.MIN/ TIME SEGMENT) | GEOMETRIC DELAY (VEH.MIN/ TIME SEGMENT) | AVERAGE DELAY PER ARRIVING VEHICLE (MIN) | I |
|---|-------------|---------------------|-----------------------|------------------------------|----------------------------------|--------------------------|------------------------|-------------------------------------|---|--|---|
| I | 18.00-18.15 | | | | | | | | | | I |
| I | B-AC | 0.74 | 9.35 | 0.079 | | 0.11 | 0.09 | 1.3 | | 0.12 | I |
| I | C-AB | 0.06 | 10.41 | 0.006 | | 0.01 | 0.01 | 0.1 | | 0.10 | I |
| I | A-B | 0.04 | | | | | | | | | I |
| I | A-C | 0.25 | | | | | | | | | I |

QUEUE FOR STREAM B-AC

| TIME SEGMENT ENDING | NO. OF VEHICLES IN QUEUE |
|------------------------|--------------------------------|
| 17.00 | 0.1 |
| 17.15 | 0.1 |
| 17.30 | 0.1 |
| 17.45 | 0.1 |
| 18.00 | 0.1 |
| 18.15 | 0.1 |

QUEUE FOR STREAM C-AB

| TIME SEGMENT ENDING | NO. OF VEHICLES IN QUEUE |
|------------------------|--------------------------------|
| 17.00 | 0.0 |
| 17.15 | 0.0 |
| 17.30 | 0.0 |
| 17.45 | 0.0 |
| 18.00 | 0.0 |
| 18.15 | 0.0 |

QUEUEING DELAY INFORMATION OVER WHOLE PERIOD

| I | STREAM | I | TOTAL DEMAND | I | * QUEUEING * | I | * INCLUSIVE QUEUEING * | I | * DELAY * | I |
|---|--------|---|--------------|---|--------------|---|------------------------|---|-----------|---|
| I | I | I | (VEH) | I | (VEH/H) | I | (MIN) | I | (MIN/VEH) | I |
| I | B-AC | I | 81.2 | I | 54.1 | I | 9.6 | I | 0.12 | I |
| I | C-AB | I | 6.9 | I | 4.6 | I | 0.7 | I | 0.10 | I |
| I | A-B | I | 4.1 | I | 2.8 | I | | I | | I |
| I | A-C | I | 27.5 | I | 18.4 | I | | I | | I |
| I | ALL | I | 177.6 | I | 118.4 | I | 10.3 | I | 0.06 | I |

* DELAY IS THAT OCCURRING ONLY WITHIN THE TIME PERIOD .
 * INCLUSIVE DELAY INCLUDES DELAY SUFFERED BY VEHICLES WHICH ARE STILL QUEUEING AFTER THE END OF THE TIME PERIOD.
 * THESE WILL ONLY BE SIGNIFICANTLY DIFFERENT IF THERE IS A LARGE QUEUE REMAINING AT THE END OF THE TIME PERIOD.

END OF JOB

===== end of file =====

TRL LIMITED

(C) COPYRIGHT 2006

CAPACITIES, QUEUES, AND DELAYS AT 3 OR 4-ARM MAJOR/MINOR PRIORITY JUNCTIONS

PICADY 5.0 ANALYSIS PROGRAM
RELEASE 3.0 (JUNE 2006)

ADAPTED FROM PICADY/3 WHICH IS CROWN COPYRIGHT
BY PERMISSION OF THE CONTROLLER OF HMSO

FOR SALES AND DISTRIBUTION INFORMATION,
PROGRAM ADVICE AND MAINTENANCE CONTACT:
TRL SOFTWARE BUREAU
TEL: CROWTHORNE (01344) 770758, FAX: 770864
EMAIL: SoftwareBureau@trl.co.uk

THE USER OF THIS COMPUTER PROGRAM FOR THE SOLUTION OF AN ENGINEERING PROBLEM IS
IN NO WAY RELIEVED OF HIS RESPONSIBILITY FOR THE CORRECTNESS OF THE SOLUTION

Run with file:-
"J:\120000\120669-00\4 Internal Project Data\4-04 Calculations\4-04-06 Junction Analysis\Picady\
Site 11. Camp Rd - Kirtlington Rd\2013 Base\AM\Site 11.Camp Rd - Kirtlington Rd 2013 Base AM.vpi"
(drive-on-the-left) at 10:16:49 on Wednesday, 8 August 2007

RUN INFORMATION

RUN TITLE: Site 11. Camp Rd - Kirtlington Rd 2013 Base AM
LOCATION: Oxfordshire
DATE: 13/07/07
CLIENT: North Oxfordshire Consortium
ENUMERATOR: Ian.Clarke
JOB NUMBER: 120669
STATUS: TIA
DESCRIPTION:

.MAJOR/MINOR JUNCTION CAPACITY AND DELAY

INPUT DATA

MAJOR ROAD (ARM C) ----- MAJOR ROAD (ARM A)
I
I
I
I
I
I
MINOR ROAD (ARM B)

ARM A IS Camp Road (E)
ARM B IS Kirtlington Rd
ARM C IS Camp Road (W)

STREAM LABELLING CONVENTION

STREAM A-B CONTAINS TRAFFIC GOING FROM ARM A TO ARM B
STREAM B-AC CONTAINS TRAFFIC GOING FROM ARM B TO ARM A AND TO ARM C
ETC.

 GEOMETRIC DATA

| I | DATA ITEM | I | MINOR ROAD B | I |
|---|------------------------------------|----------|--------------|---|
| I | TOTAL MAJOR ROAD CARRIAGEWAY WIDTH | I (W) | 6.00 M. | I |
| I | CENTRAL RESERVE WIDTH | I (WCR) | 0.00 M. | I |
| I | | I | | I |
| I | MAJOR ROAD RIGHT TURN - WIDTH | I (WC-B) | 2.20 M. | I |
| I | - VISIBILITY | I (VC-B) | 95.0 M. | I |
| I | - BLOCKS TRAFFIC | I | YES | I |
| I | | I | | I |
| I | MINOR ROAD - VISIBILITY TO LEFT | I (VB-C) | 21.0 M. | I |
| I | - VISIBILITY TO RIGHT | I (VB-A) | 16.0 M. | I |
| I | - LANE 1 WIDTH | I (WB-C) | 2.50 M. | I |
| I | - LANE 2 WIDTH | I (WB-A) | 0.00 M. | I |

.SLOPES AND INTERCEPT

(NB:Streams may be combined, in which case capacity will be adjusted)

| I | Intercept For Stream B-C | Slope For Stream A-C | Slope For Opposing Stream A-B | I |
|---|--------------------------|----------------------|-------------------------------|---|
| I | 602.27 | 0.23 | 0.09 | I |

| I | Intercept For Stream B-A | Slope For Stream A-C | Slope For Opposing Stream A-B | Slope For Opposing Stream C-A | Slope For Opposing Stream C-B | I |
|---|--------------------------|----------------------|-------------------------------|-------------------------------|-------------------------------|---|
| I | 467.65 | 0.22 | 0.09 | 0.14 | 0.31 | I |

| I | Intercept For Stream C-B | Slope For Stream A-C | Slope For Opposing Stream A-B | I |
|---|--------------------------|----------------------|-------------------------------|---|
| I | 628.98 | 0.24 | 0.24 | I |

NB These values do not allow for any site specific corrections

TRAFFIC DEMAND DATA

| I | ARM | I | FLOW SCALE(%) | I |
|---|-----|---|---------------|---|
| I | A | I | 100 | I |
| I | B | I | 100 | I |
| I | C | I | 100 | I |

Demand set: Site 11. Camp Rd - Kirtlington Rd 2013 Base AM

TIME PERIOD BEGINS 07.45 AND ENDS 09.15

LENGTH OF TIME PERIOD - 90 MINUTES.
 LENGTH OF TIME SEGMENT - 15 MINUTES.

DEMAND FLOW PROFILES ARE SYNTHESISED FROM TURNING COUNT DATA

| I | ARM | I | NUMBER OF MINUTES FROM START WHEN FLOW STARTS TO RISE | I | TOP OF PEAK IS REACHED | I | FLOW STOPS FALLING | I | RATE OF FLOW (VEH/MIN) BEFORE PEAK | I | AT TOP OF PEAK | I | AFTER PEAK |
|---|-------|---|---|---|------------------------|---|--------------------|---|------------------------------------|---|----------------|---|------------|
| I | ARM A | I | 15.00 | I | 45.00 | I | 75.00 | I | 0.77 | I | 1.16 | I | 0.77 |
| I | ARM B | I | 15.00 | I | 45.00 | I | 75.00 | I | 0.05 | I | 0.08 | I | 0.05 |
| I | ARM C | I | 15.00 | I | 45.00 | I | 75.00 | I | 0.77 | I | 1.16 | I | 0.77 |

| I | TIME | DEMAND (VEH/MIN) | CAPACITY (VEH/MIN) | DEMAND/ CAPACITY (RFC) | PEDESTRIAN FLOW (PEDS/MIN) | START QUEUE (VEHS) | END QUEUE (VEHS) | DELAY (VEH.MIN/ TIME SEGMENT) | GEOMETRIC DELAY (VEH.MIN/ TIME SEGMENT) | AVERAGE DELAY PER ARRIVING VEHICLE (MIN) | I |
|---|-------------|---------------------|-----------------------|------------------------------|----------------------------------|--------------------------|------------------------|-------------------------------------|---|--|---|
| I | 08.45-09.00 | | | | | | | | | | I |
| I | B-AC | 0.06 | 8.47 | 0.007 | | 0.01 | 0.01 | 0.1 | | 0.12 | I |
| I | C-AB | 0.25 | 10.26 | 0.025 | | 0.03 | 0.03 | 0.4 | | 0.10 | I |
| I | A-B | 0.12 | | | | | | | | | I |
| I | A-C | 0.81 | | | | | | | | | I |

| I | TIME | DEMAND (VEH/MIN) | CAPACITY (VEH/MIN) | DEMAND/ CAPACITY (RFC) | PEDESTRIAN FLOW (PEDS/MIN) | START QUEUE (VEHS) | END QUEUE (VEHS) | DELAY (VEH.MIN/ TIME SEGMENT) | GEOMETRIC DELAY (VEH.MIN/ TIME SEGMENT) | AVERAGE DELAY PER ARRIVING VEHICLE (MIN) | I |
|---|-------------|---------------------|-----------------------|------------------------------|----------------------------------|--------------------------|------------------------|-------------------------------------|---|--|---|
| I | 09.00-09.15 | | | | | | | | | | I |
| I | B-AC | 0.05 | 8.52 | 0.006 | | 0.01 | 0.01 | 0.1 | | 0.12 | I |
| I | C-AB | 0.21 | 10.29 | 0.021 | | 0.03 | 0.02 | 0.3 | | 0.10 | I |
| I | A-B | 0.10 | | | | | | | | | I |
| I | A-C | 0.68 | | | | | | | | | I |

QUEUE FOR STREAM B-AC

| TIME SEGMENT ENDING | NO. OF VEHICLES IN QUEUE |
|------------------------|--------------------------------|
| 08.00 | 0.0 |
| 08.15 | 0.0 |
| 08.30 | 0.0 |
| 08.45 | 0.0 |
| 09.00 | 0.0 |
| 09.15 | 0.0 |

QUEUE FOR STREAM C-AB

| TIME SEGMENT ENDING | NO. OF VEHICLES IN QUEUE |
|------------------------|--------------------------------|
| 08.00 | 0.0 |
| 08.15 | 0.0 |
| 08.30 | 0.0 |
| 08.45 | 0.0 |
| 09.00 | 0.0 |
| 09.15 | 0.0 |

QUEUEING DELAY INFORMATION OVER WHOLE PERIOD

| I | STREAM | I | TOTAL DEMAND | I | * QUEUEING * | I | * INCLUSIVE QUEUEING * | I | * DELAY * | I |
|---|--------|---|--------------|---|--------------|---|------------------------|---|-----------|---|
| I | I | I | (VEH) | I | (MIN) | I | (MIN) | I | (MIN) | I |
| I | B-AC | I | 5.5 | I | 3.7 | I | 0.7 | I | 0.12 | I |
| I | C-AB | I | 23.4 | I | 15.6 | I | 2.3 | I | 0.10 | I |
| I | A-B | I | 11.0 | I | 7.3 | I | | I | | I |
| I | A-C | I | 74.3 | I | 49.6 | I | | I | | I |
| I | ALL | I | 176.2 | I | 117.5 | I | 3.0 | I | 0.02 | I |

* DELAY IS THAT OCCURRING ONLY WITHIN THE TIME PERIOD .
 * INCLUSIVE DELAY INCLUDES DELAY SUFFERED BY VEHICLES WHICH ARE STILL QUEUEING AFTER THE END OF THE TIME PERIOD.
 * THESE WILL ONLY BE SIGNIFICANTLY DIFFERENT IF THERE IS A LARGE QUEUE REMAINING AT THE END OF THE TIME PERIOD.

END OF JOB

===== end of file =====

TRL LIMITED

(C) COPYRIGHT 2006

CAPACITIES, QUEUES, AND DELAYS AT 3 OR 4-ARM MAJOR/MINOR PRIORITY JUNCTIONS

PICADY 5.0 ANALYSIS PROGRAM
RELEASE 3.0 (JUNE 2006)

ADAPTED FROM PICADY/3 WHICH IS CROWN COPYRIGHT
BY PERMISSION OF THE CONTROLLER OF HMSO

FOR SALES AND DISTRIBUTION INFORMATION,
PROGRAM ADVICE AND MAINTENANCE CONTACT:
TRL SOFTWARE BUREAU
TEL: CROWTHORNE (01344) 770758, FAX: 770864
EMAIL: SoftwareBureau@trl.co.uk

THE USER OF THIS COMPUTER PROGRAM FOR THE SOLUTION OF AN ENGINEERING PROBLEM IS
IN NO WAY RELIEVED OF HIS RESPONSIBILITY FOR THE CORRECTNESS OF THE SOLUTION

Run with file:-

"J:\120000\120669-00\4 Internal Project Data\4-04 Calculations\4-04-06 Junction Analysis\Picady\
Site 11. Camp Rd - Kirtlington Rd\2013 Base\PM\Site 11.Camp Rd - Kirtlington Rd 2013 Base PM.vpi"
(drive-on-the-left) at 10:23:04 on Wednesday, 8 August 2007

RUN INFORMATION

RUN TITLE: Site 11. Camp Rd - Kirtlington Rd 2013 Base PM
LOCATION: Oxfordshire
DATE: 09/11/06
CLIENT: North Oxfordshire Consortium
ENUMERATOR: Chris.Morris [MCCPC062011]
JOB NUMBER: 120669
STATUS: TIA
DESCRIPTION:

.MAJOR/MINOR JUNCTION CAPACITY AND DELAY

INPUT DATA

MAJOR ROAD (ARM C) ----- MAJOR ROAD (ARM A)
I
I
I
I
I
I
MINOR ROAD (ARM B)

ARM A IS Camp Road (E)
ARM B IS Kirtlington Rd
ARM C IS Camp Road (W)

STREAM LABELLING CONVENTION

STREAM A-B CONTAINS TRAFFIC GOING FROM ARM A TO ARM B
STREAM B-AC CONTAINS TRAFFIC GOING FROM ARM B TO ARM A AND TO ARM C
ETC.

 GEOMETRIC DATA

| I | DATA ITEM | I | MINOR ROAD B | I |
|---|------------------------------------|----------|--------------|---|
| I | TOTAL MAJOR ROAD CARRIAGEWAY WIDTH | I (W) | 6.00 M. | I |
| I | CENTRAL RESERVE WIDTH | I (WCR) | 0.00 M. | I |
| I | | I | | I |
| I | MAJOR ROAD RIGHT TURN - WIDTH | I (WC-B) | 2.20 M. | I |
| I | - VISIBILITY | I (VC-B) | 95.0 M. | I |
| I | - BLOCKS TRAFFIC | I | YES | I |
| I | | I | | I |
| I | MINOR ROAD - VISIBILITY TO LEFT | I (VB-C) | 21.0 M. | I |
| I | - VISIBILITY TO RIGHT | I (VB-A) | 16.0 M. | I |
| I | - LANE 1 WIDTH | I (WB-C) | 2.50 M. | I |
| I | - LANE 2 WIDTH | I (WB-A) | 0.00 M. | I |

.SLOPES AND INTERCEPT

(NB:Streams may be combined, in which case capacity will be adjusted)

| I | Intercept For Stream B-C | Slope For Stream A-C | Slope For Opposing Stream A-B | I |
|---|--------------------------|----------------------|-------------------------------|---|
| I | 602.27 | 0.23 | 0.09 | I |

| I | Intercept For Stream B-A | Slope For Stream A-C | Slope For Opposing Stream A-B | Slope For Opposing Stream C-A | Slope For Opposing Stream C-B | I |
|---|--------------------------|----------------------|-------------------------------|-------------------------------|-------------------------------|---|
| I | 467.65 | 0.22 | 0.09 | 0.14 | 0.31 | I |

| I | Intercept For Stream C-B | Slope For Stream A-C | Slope For Opposing Stream A-B | I |
|---|--------------------------|----------------------|-------------------------------|---|
| I | 628.98 | 0.24 | 0.24 | I |

NB These values do not allow for any site specific corrections

 TRAFFIC DEMAND DATA

| I | ARM | I | FLOW SCALE (%) | I |
|---|-----|---|----------------|---|
| I | A | I | 100 | I |
| I | B | I | 100 | I |
| I | C | I | 100 | I |

Demand set: Site 11. Camp Rd - Kirtlington Rd 2013 Base PM

TIME PERIOD BEGINS 16.45 AND ENDS 18.15

LENGTH OF TIME PERIOD - 90 MINUTES.
 LENGTH OF TIME SEGMENT - 15 MINUTES.

DEMAND FLOW PROFILES ARE SYNTHESISED FROM TURNING COUNT DATA

| I | ARM | I | NUMBER OF MINUTES FROM START WHEN FLOW STARTS TO RISE | I | TOP OF PEAK IS REACHED | I | FLOW STOPS FALLING | I | RATE OF FLOW (VEH/MIN) BEFORE PEAK | I | AT TOP OF PEAK | I | AFTER PEAK |
|---|-------|---|---|---|------------------------|---|--------------------|---|------------------------------------|---|----------------|---|------------|
| I | ARM A | I | 15.00 | I | 45.00 | I | 75.00 | I | 0.31 | I | 0.47 | I | 0.31 |
| I | ARM B | I | 15.00 | I | 45.00 | I | 75.00 | I | 0.82 | I | 1.24 | I | 0.82 |
| I | ARM C | I | 15.00 | I | 45.00 | I | 75.00 | I | 0.66 | I | 0.99 | I | 0.66 |

| I | TIME | DEMAND (VEH/MIN) | CAPACITY (VEH/MIN) | DEMAND/ CAPACITY (RFC) | PEDESTRIAN FLOW (PEDS/MIN) | START QUEUE (VEHS) | END QUEUE (VEHS) | DELAY (VEH.MIN/ TIME SEGMENT) | GEOMETRIC DELAY (VEH.MIN/ TIME SEGMENT) | AVERAGE DELAY PER ARRIVING VEHICLE (MIN) | I |
|---|-------------|---------------------|-----------------------|------------------------------|----------------------------------|--------------------------|------------------------|-------------------------------------|---|--|---|
| I | 17.45-18.00 | | | | | | | | | | I |
| I | B-AC | 0.99 | 9.30 | 0.106 | | 0.15 | 0.12 | 1.8 | | 0.12 | I |
| I | C-AB | 0.07 | 10.39 | 0.007 | | 0.01 | 0.01 | 0.1 | | 0.10 | I |
| I | A-B | 0.04 | | | | | | | | | I |
| I | A-C | 0.33 | | | | | | | | | I |

| I | TIME | DEMAND (VEH/MIN) | CAPACITY (VEH/MIN) | DEMAND/ CAPACITY (RFC) | PEDESTRIAN FLOW (PEDS/MIN) | START QUEUE (VEHS) | END QUEUE (VEHS) | DELAY (VEH.MIN/ TIME SEGMENT) | GEOMETRIC DELAY (VEH.MIN/ TIME SEGMENT) | AVERAGE DELAY PER ARRIVING VEHICLE (MIN) | I |
|---|-------------|---------------------|-----------------------|------------------------------|----------------------------------|--------------------------|------------------------|-------------------------------------|---|--|---|
| I | 18.00-18.15 | | | | | | | | | | I |
| I | B-AC | 0.83 | 9.32 | 0.089 | | 0.12 | 0.10 | 1.5 | | 0.12 | I |
| I | C-AB | 0.06 | 10.41 | 0.006 | | 0.01 | 0.01 | 0.1 | | 0.10 | I |
| I | A-B | 0.04 | | | | | | | | | I |
| I | A-C | 0.28 | | | | | | | | | I |

QUEUE FOR STREAM B-AC

| TIME SEGMENT ENDING | NO. OF VEHICLES IN QUEUE |
|------------------------|--------------------------------|
| 17.00 | 0.1 |
| 17.15 | 0.1 |
| 17.30 | 0.1 |
| 17.45 | 0.1 |
| 18.00 | 0.1 |
| 18.15 | 0.1 |

QUEUE FOR STREAM C-AB

| TIME SEGMENT ENDING | NO. OF VEHICLES IN QUEUE |
|------------------------|--------------------------------|
| 17.00 | 0.0 |
| 17.15 | 0.0 |
| 17.30 | 0.0 |
| 17.45 | 0.0 |
| 18.00 | 0.0 |
| 18.15 | 0.0 |

QUEUEING DELAY INFORMATION OVER WHOLE PERIOD

| I | STREAM | I | TOTAL DEMAND (VEH) | I | 60.6 (VEH/H) | I | * QUEUEING * (MIN) | I | 0.12 (MIN/VEH) | I | * INCLUSIVE QUEUEING * (MIN) | I | 0.12 (MIN/VEH) | I |
|---|--------|---|-----------------------|---|-----------------|---|-----------------------|---|-------------------|---|---------------------------------|---|-------------------|---|
| I | B-AC | I | 90.8 | I | 60.6 | I | 10.9 | I | 0.12 | I | 10.9 | I | 0.12 | I |
| I | C-AB | I | 6.9 | I | 4.6 | I | 0.7 | I | 0.10 | I | 0.7 | I | 0.10 | I |
| I | A-B | I | 4.1 | I | 2.8 | I | | I | | I | | I | | I |
| I | A-C | I | 30.3 | I | 20.2 | I | | I | | I | | I | | I |
| I | ALL | I | 198.2 | I | 132.1 | I | 11.6 | I | 0.06 | I | 11.6 | I | 0.06 | I |

* DELAY IS THAT OCCURRING ONLY WITHIN THE TIME PERIOD .
 * INCLUSIVE DELAY INCLUDES DELAY SUFFERED BY VEHICLES WHICH ARE STILL QUEUEING AFTER THE END OF THE TIME PERIOD.
 * THESE WILL ONLY BE SIGNIFICANTLY DIFFERENT IF THERE IS A LARGE QUEUE REMAINING AT THE END OF THE TIME PERIOD.

END OF JOB

===== end of file =====

TRL LIMITED

(C) COPYRIGHT 2006

CAPACITIES, QUEUES, AND DELAYS AT 3 OR 4-ARM MAJOR/MINOR PRIORITY JUNCTIONS

PICADY 5.0 ANALYSIS PROGRAM
RELEASE 3.0 (JUNE 2006)

ADAPTED FROM PICADY/3 WHICH IS CROWN COPYRIGHT
BY PERMISSION OF THE CONTROLLER OF HMSO

FOR SALES AND DISTRIBUTION INFORMATION,
PROGRAM ADVICE AND MAINTENANCE CONTACT:
TRL SOFTWARE BUREAU
TEL: CROWTHORNE (01344) 770758, FAX: 770864
EMAIL: SoftwareBureau@trl.co.uk

THE USER OF THIS COMPUTER PROGRAM FOR THE SOLUTION OF AN ENGINEERING PROBLEM IS
IN NO WAY RELIEVED OF HIS RESPONSIBILITY FOR THE CORRECTNESS OF THE SOLUTION

Run with file:-

"J:\120000\120669-00\4 Internal Project Data\4-04 Calculations\4-04-06 Junction Analysis\Picady\
Site 11. Camp Rd - Kirtlington Rd\2013 Base + Gen\AM\
Site 11.Camp Rd - Kirtlington Rd 2013 Base + Full Development AM.vpi"
(drive-on-the-left) at 16:26:54 on Tuesday, 31 July 2007

RUN INFORMATION

RUN TITLE: Site 11. Camp Rd - Kirtlington Rd 2013 Base + Full Development AM
LOCATION: Oxfordshire
DATE: 31/07/07
CLIENT: North Oxfordshire Consortium
ENUMERATOR: Ian.Clarke
JOB NUMBER: 120669
STATUS: TIA

DESCRIPTION:

.MAJOR/MINOR JUNCTION CAPACITY AND DELAY

INPUT DATA

MAJOR ROAD (ARM C) ----- MAJOR ROAD (ARM A)
I
I
I
I
I
I
MINOR ROAD (ARM B)

ARM A IS Camp Road (E)
ARM B IS Kirtlington Rd
ARM C IS Camp Road (W)

STREAM LABELLING CONVENTION

STREAM A-B CONTAINS TRAFFIC GOING FROM ARM A TO ARM B
STREAM B-AC CONTAINS TRAFFIC GOING FROM ARM B TO ARM A AND TO ARM C
ETC.

 GEOMETRIC DATA

| I | DATA ITEM | I | MINOR ROAD B | I |
|---|------------------------------------|----------|--------------|---|
| I | TOTAL MAJOR ROAD CARRIAGEWAY WIDTH | I (W) | 6.00 M. | I |
| I | CENTRAL RESERVE WIDTH | I (WCR) | 0.00 M. | I |
| I | | I | | I |
| I | MAJOR ROAD RIGHT TURN - WIDTH | I (WC-B) | 2.20 M. | I |
| I | - VISIBILITY | I (VC-B) | 95.0 M. | I |
| I | - BLOCKS TRAFFIC | I | YES | I |
| I | | I | | I |
| I | MINOR ROAD - VISIBILITY TO LEFT | I (VB-C) | 21.0 M. | I |
| I | - VISIBILITY TO RIGHT | I (VB-A) | 16.0 M. | I |
| I | - LANE 1 WIDTH | I (WB-C) | 2.50 M. | I |
| I | - LANE 2 WIDTH | I (WB-A) | 0.00 M. | I |

.SLOPES AND INTERCEPT

(NB:Streams may be combined, in which case capacity will be adjusted)

| I | Intercept For Stream B-C | Slope For Stream A-C | Slope For Opposing Stream A-B | I |
|---|--------------------------|----------------------|-------------------------------|---|
| I | 602.27 | 0.23 | 0.09 | I |

| I | Intercept For Stream B-A | Slope For Stream A-C | Slope For Opposing Stream A-B | Slope For Opposing Stream C-A | Slope For Opposing Stream C-B | I |
|---|--------------------------|----------------------|-------------------------------|-------------------------------|-------------------------------|---|
| I | 467.65 | 0.22 | 0.09 | 0.14 | 0.31 | I |

| I | Intercept For Stream C-B | Slope For Stream A-C | Slope For Opposing Stream A-B | I |
|---|--------------------------|----------------------|-------------------------------|---|
| I | 628.98 | 0.24 | 0.24 | I |

NB These values do not allow for any site specific corrections

TRAFFIC DEMAND DATA

| I | ARM | I | FLOW SCALE(%) | I |
|---|-----|---|---------------|---|
| I | A | I | 100 | I |
| I | B | I | 100 | I |
| I | C | I | 100 | I |

Demand set: Site 11. Camp Rd - Kirtlington Rd 2013 Base AM

TIME PERIOD BEGINS 07.45 AND ENDS 09.15

LENGTH OF TIME PERIOD - 90 MINUTES.
 LENGTH OF TIME SEGMENT - 15 MINUTES.

DEMAND FLOW PROFILES ARE SYNTHESISED FROM TURNING COUNT DATA

| I | ARM | I | NUMBER OF MINUTES FROM START WHEN FLOW STARTS TO RISE | I | TOP OF PEAK IS REACHED | I | FLOW STOPS FALLING | I | RATE OF FLOW (VEH/MIN) BEFORE PEAK | I | AT TOP OF PEAK | I | AFTER PEAK |
|---|-------|---|---|---|------------------------|---|--------------------|---|------------------------------------|---|----------------|---|------------|
| I | ARM A | I | 15.00 | I | 45.00 | I | 75.00 | I | 3.89 | I | 5.83 | I | 3.89 |
| I | ARM B | I | 15.00 | I | 45.00 | I | 75.00 | I | 0.71 | I | 1.07 | I | 0.71 |
| I | ARM C | I | 15.00 | I | 45.00 | I | 75.00 | I | 3.42 | I | 5.14 | I | 3.42 |

| I | TIME | DEMAND (VEH/MIN) | CAPACITY (VEH/MIN) | DEMAND/ CAPACITY (RFC) | PEDESTRIAN FLOW (PEDS/MIN) | START QUEUE (VEHS) | END QUEUE (VEHS) | DELAY (VEH.MIN/ TIME SEGMENT) | GEOMETRIC DELAY (VEH.MIN/ TIME SEGMENT) | AVERAGE DELAY PER ARRIVING VEHICLE (MIN) | I |
|---|-------------|---------------------|-----------------------|------------------------------|----------------------------------|--------------------------|------------------------|-------------------------------------|---|--|---|
| I | 08.45-09.00 | | | | | | | | | | I |
| I | B-AC | 0.85 | 6.43 | 0.133 | | 0.21 | 0.16 | 2.4 | | 0.18 | I |
| I | C-AB | 0.25 | 9.35 | 0.027 | | 0.04 | 0.03 | 0.4 | | 0.11 | I |
| I | A-B | 1.30 | | | | | | | | | I |
| I | A-C | 3.36 | | | | | | | | | I |

| I | TIME | DEMAND (VEH/MIN) | CAPACITY (VEH/MIN) | DEMAND/ CAPACITY (RFC) | PEDESTRIAN FLOW (PEDS/MIN) | START QUEUE (VEHS) | END QUEUE (VEHS) | DELAY (VEH.MIN/ TIME SEGMENT) | GEOMETRIC DELAY (VEH.MIN/ TIME SEGMENT) | AVERAGE DELAY PER ARRIVING VEHICLE (MIN) | I |
|---|-------------|---------------------|-----------------------|------------------------------|----------------------------------|--------------------------|------------------------|-------------------------------------|---|--|---|
| I | 09.00-09.15 | | | | | | | | | | I |
| I | B-AC | 0.72 | 6.66 | 0.107 | | 0.16 | 0.12 | 1.9 | | 0.17 | I |
| I | C-AB | 0.21 | 9.53 | 0.022 | | 0.03 | 0.02 | 0.3 | | 0.11 | I |
| I | A-B | 1.09 | | | | | | | | | I |
| I | A-C | 2.81 | | | | | | | | | I |

QUEUE FOR STREAM B-AC

| TIME SEGMENT ENDING | NO. OF VEHICLES IN QUEUE |
|------------------------|--------------------------------|
| 08.00 | 0.1 |
| 08.15 | 0.2 |
| 08.30 | 0.2 |
| 08.45 | 0.2 |
| 09.00 | 0.2 |
| 09.15 | 0.1 |

QUEUE FOR STREAM C-AB

| TIME SEGMENT ENDING | NO. OF VEHICLES IN QUEUE |
|------------------------|--------------------------------|
| 08.00 | 0.0 |
| 08.15 | 0.0 |
| 08.30 | 0.0 |
| 08.45 | 0.0 |
| 09.00 | 0.0 |
| 09.15 | 0.0 |

QUEUEING DELAY INFORMATION OVER WHOLE PERIOD

| I | STREAM | I | TOTAL DEMAND | I | * QUEUEING * | I | * INCLUSIVE QUEUEING * | I | * DELAY * | I |
|---|--------|---|--------------|---|--------------|---|------------------------|---|-----------|---|
| I | I | I | (VEH) | I | (MIN) | I | (MIN) | I | (MIN/VEH) | I |
| I | B-AC | I | 78.5 | I | 14.2 | I | 14.2 | I | 0.18 | I |
| I | C-AB | I | 23.4 | I | 2.6 | I | 2.6 | I | 0.11 | I |
| I | A-B | I | 119.7 | I | | I | | I | | I |
| I | A-C | I | 308.3 | I | | I | | I | | I |
| I | ALL | I | 883.7 | I | 16.8 | I | 16.8 | I | 0.02 | I |

* DELAY IS THAT OCCURRING ONLY WITHIN THE TIME PERIOD .
 * INCLUSIVE DELAY INCLUDES DELAY SUFFERED BY VEHICLES WHICH ARE STILL QUEUEING AFTER THE END OF THE TIME PERIOD.
 * THESE WILL ONLY BE SIGNIFICANTLY DIFFERENT IF THERE IS A LARGE QUEUE REMAINING AT THE END OF THE TIME PERIOD.

END OF JOB

===== end of file =====

TRL LIMITED

(C) COPYRIGHT 2006

CAPACITIES, QUEUES, AND DELAYS AT 3 OR 4-ARM MAJOR/MINOR PRIORITY JUNCTIONS

PICADY 5.0 ANALYSIS PROGRAM
RELEASE 3.0 (JUNE 2006)

ADAPTED FROM PICADY/3 WHICH IS CROWN COPYRIGHT
BY PERMISSION OF THE CONTROLLER OF HMSO

FOR SALES AND DISTRIBUTION INFORMATION,
PROGRAM ADVICE AND MAINTENANCE CONTACT:
TRL SOFTWARE BUREAU
TEL: CROWTHORNE (01344) 770758, FAX: 770864
EMAIL: SoftwareBureau@trl.co.uk

THE USER OF THIS COMPUTER PROGRAM FOR THE SOLUTION OF AN ENGINEERING PROBLEM IS
IN NO WAY RELIEVED OF HIS RESPONSIBILITY FOR THE CORRECTNESS OF THE SOLUTION

Run with file:-

"J:\120000\120669-00\4 Internal Project Data\4-04 Calculations\4-04-06 Junction Analysis\Picady\
Site 11. Camp Rd - Kirtlington Rd\2013 Base + Gen\PM\
Site 11.Camp Rd - Kirtlington Rd 2013 Base + Full Development PM.vpi"
(drive-on-the-left) at 09:21:22 on Wednesday, 8 August 2007

RUN INFORMATION

RUN TITLE: Site 11. Camp Rd - Kirtlington Rd 2013 Base + Full Development PM
LOCATION: Oxfordshire
DATE: 08/08/07
CLIENT: North Oxfordshire Consortium
ENUMERATOR: Ian Clarke
JOB NUMBER: 120669
STATUS: TIA

DESCRIPTION:

.MAJOR/MINOR JUNCTION CAPACITY AND DELAY

INPUT DATA

MAJOR ROAD (ARM C) ----- MAJOR ROAD (ARM A)
I
I
I
I
I
I
MINOR ROAD (ARM B)

ARM A IS Camp Road (E)
ARM B IS Kirtlington Rd
ARM C IS Camp Road (W)

STREAM LABELLING CONVENTION

STREAM A-B CONTAINS TRAFFIC GOING FROM ARM A TO ARM B
STREAM B-AC CONTAINS TRAFFIC GOING FROM ARM B TO ARM A AND TO ARM C
ETC.

 GEOMETRIC DATA

| DATA ITEM | MINOR ROAD B |
|------------------------------------|----------------|
| TOTAL MAJOR ROAD CARRIAGEWAY WIDTH | (W) 6.00 M. |
| CENTRAL RESERVE WIDTH | (WCR) 0.00 M. |
| MAJOR ROAD RIGHT TURN - WIDTH | (WC-B) 2.20 M. |
| - VISIBILITY | (VC-B) 95.0 M. |
| - BLOCKS TRAFFIC | YES |
| MINOR ROAD - VISIBILITY TO LEFT | (VB-C) 21.0 M. |
| - VISIBILITY TO RIGHT | (VB-A) 16.0 M. |
| - LANE 1 WIDTH | (WB-C) 2.50 M. |
| - LANE 2 WIDTH | (WB-A) 0.00 M. |

.SLOPES AND INTERCEPT

(NB:Streams may be combined, in which case capacity will be adjusted)

| Intercept For Stream B-C | Slope For Stream A-C | Slope For Stream A-B |
|--------------------------|----------------------|----------------------|
| 602.27 | 0.23 | 0.09 |

| Intercept For Stream B-A | Slope For Stream A-C | Slope For Stream A-B | Slope For Stream C-A | Slope For Stream C-B |
|--------------------------|----------------------|----------------------|----------------------|----------------------|
| 467.65 | 0.22 | 0.09 | 0.14 | 0.31 |

| Intercept For Stream C-B | Slope For Stream A-C | Slope For Stream A-B |
|--------------------------|----------------------|----------------------|
| 628.98 | 0.24 | 0.24 |

NB These values do not allow for any site specific corrections

TRAFFIC DEMAND DATA

| ARM | FLOW SCALE (%) |
|-----|----------------|
| A | 100 |
| B | 100 |
| C | 100 |

Demand set: Site 11. Camp Rd - Kirtlington Rd 2013 Base + Gen PM

TIME PERIOD BEGINS 16.45 AND ENDS 18.15

LENGTH OF TIME PERIOD - 90 MINUTES.
 LENGTH OF TIME SEGMENT - 15 MINUTES.

DEMAND FLOW PROFILES ARE SYNTHESISED FROM TURNING COUNT DATA

| ARM | NUMBER OF MINUTES FROM START WHEN FLOW STARTS TO RISE | TOP OF PEAK IS REACHED | FLOW STOPS FALLING | RATE OF FLOW (VEH/MIN) BEFORE PEAK | AT TOP OF PEAK | AFTER PEAK |
|-------|---|------------------------|--------------------|------------------------------------|----------------|------------|
| ARM A | 15.00 | 45.00 | 75.00 | 3.78 | 5.66 | 3.78 |
| ARM B | 15.00 | 45.00 | 75.00 | 1.65 | 2.47 | 1.65 |
| ARM C | 15.00 | 45.00 | 75.00 | 2.58 | 3.86 | 2.58 |

| I | TIME | DEMAND (VEH/MIN) | CAPACITY (VEH/MIN) | DEMAND/ CAPACITY (RFC) | PEDESTRIAN FLOW (PEDS/MIN) | START QUEUE (VEHS) | END QUEUE (VEHS) | DELAY (VEH.MIN/ TIME SEGMENT) | GEOMETRIC DELAY (VEH.MIN/ TIME SEGMENT) | AVERAGE DELAY PER ARRIVING VEHICLE (MIN) | I |
|---|-------------|---------------------|-----------------------|------------------------------|----------------------------------|--------------------------|------------------------|-------------------------------------|---|--|---|
| I | 17.45-18.00 | | | | | | | | | | I |
| I | B-AC | 1.98 | 7.32 | 0.270 | | 0.52 | 0.38 | 5.9 | | 0.19 | I |
| I | C-AB | 0.07 | 9.38 | 0.008 | | 0.01 | 0.01 | 0.1 | | 0.11 | I |
| I | A-B | 0.97 | | | | | | | | | I |
| I | A-C | 3.55 | | | | | | | | | I |

| I | TIME | DEMAND (VEH/MIN) | CAPACITY (VEH/MIN) | DEMAND/ CAPACITY (RFC) | PEDESTRIAN FLOW (PEDS/MIN) | START QUEUE (VEHS) | END QUEUE (VEHS) | DELAY (VEH.MIN/ TIME SEGMENT) | GEOMETRIC DELAY (VEH.MIN/ TIME SEGMENT) | AVERAGE DELAY PER ARRIVING VEHICLE (MIN) | I |
|---|-------------|---------------------|-----------------------|------------------------------|----------------------------------|--------------------------|------------------------|-------------------------------------|---|--|---|
| I | 18.00-18.15 | | | | | | | | | | I |
| I | B-AC | 1.66 | 7.52 | 0.220 | | 0.38 | 0.29 | 4.4 | | 0.17 | I |
| I | C-AB | 0.06 | 9.56 | 0.007 | | 0.01 | 0.01 | 0.1 | | 0.11 | I |
| I | A-B | 0.82 | | | | | | | | | I |
| I | A-C | 2.97 | | | | | | | | | I |

QUEUE FOR STREAM B-AC

| TIME SEGMENT ENDING | NO. OF VEHICLES IN QUEUE |
|------------------------|--------------------------------|
| 17.00 | 0.3 |
| 17.15 | 0.4 |
| 17.30 | 0.5 * |
| 17.45 | 0.5 * |
| 18.00 | 0.4 |
| 18.15 | 0.3 |

QUEUE FOR STREAM C-AB

| TIME SEGMENT ENDING | NO. OF VEHICLES IN QUEUE |
|------------------------|--------------------------------|
| 17.00 | 0.0 |
| 17.15 | 0.0 |
| 17.30 | 0.0 |
| 17.45 | 0.0 |
| 18.00 | 0.0 |
| 18.15 | 0.0 |

QUEUEING DELAY INFORMATION OVER WHOLE PERIOD

| I | STREAM | I | TOTAL DEMAND | I | * QUEUEING * * DELAY * | I | * INCLUSIVE QUEUEING * * DELAY * | I | I |
|---|--------|---|--------------|---|---------------------------|---|-------------------------------------|---|-----------|
| I | I | I | (VEH) | I | (VEH/H) | I | (MIN) | I | (MIN/VEH) |
| I | B-AC | I | 181.7 | I | 121.1 | I | 34.7 | I | 0.19 |
| I | C-AB | I | 6.9 | I | 4.6 | I | 0.7 | I | 0.11 |
| I | A-B | I | 89.5 | I | 59.6 | I | | I | |
| I | A-C | I | 326.2 | I | 217.5 | I | | I | |
| I | ALL | I | 880.9 | I | 587.3 | I | 35.4 | I | 0.04 |

* DELAY IS THAT OCCURRING ONLY WITHIN THE TIME PERIOD .
 * INCLUSIVE DELAY INCLUDES DELAY SUFFERED BY VEHICLES WHICH ARE STILL QUEUEING AFTER THE END OF THE TIME PERIOD.
 * THESE WILL ONLY BE SIGNIFICANTLY DIFFERENT IF THERE IS A LARGE QUEUE REMAINING AT THE END OF THE TIME PERIOD.

END OF JOB

===== end of file =====

TRL LIMITED

(C) COPYRIGHT 2006

CAPACITIES, QUEUES, AND DELAYS AT 3 OR 4-ARM MAJOR/MINOR PRIORITY JUNCTIONS

PICADY 5.0 ANALYSIS PROGRAM
RELEASE 3.0 (JUNE 2006)

ADAPTED FROM PICADY/3 WHICH IS CROWN COPYRIGHT
BY PERMISSION OF THE CONTROLLER OF HMSO

FOR SALES AND DISTRIBUTION INFORMATION,
PROGRAM ADVICE AND MAINTENANCE CONTACT:
TRL SOFTWARE BUREAU
TEL: CROWTHORNE (01344) 770758, FAX: 770864
EMAIL: SoftwareBureau@trl.co.uk

THE USER OF THIS COMPUTER PROGRAM FOR THE SOLUTION OF AN ENGINEERING PROBLEM IS
IN NO WAY RELIEVED OF HIS RESPONSIBILITY FOR THE CORRECTNESS OF THE SOLUTION

Run with file:-
"J:\120000\120669-00\4 Internal Project Data\4-04 Calculations\4-04-06 Junction Analysis\Picady\
Site 12. Somerton Rd - Camp Rd\2006 Base\AM\Site 12. Camp Rd - Somerton Rd 2006 Base AM.vpi"
(drive-on-the-left) at 10:58:21 on Wednesday, 8 August 2007

RUN INFORMATION

RUN TITLE: Site 12. Camp Road - Somerton Rd 2006 Base AM
LOCATION: Oxfordshire
DATE: 10/07/07
CLIENT: North Oxfordshire Consortium
ENUMERATOR: Chris.Morris [MCCPC062011]
JOB NUMBER: 120669
STATUS: TIA
DESCRIPTION:

.MAJOR/MINOR JUNCTION CAPACITY AND DELAY

INPUT DATA

MAJOR ROAD (ARM C) ----- MAJOR ROAD (ARM A)
I
I
I
I
I
I
MINOR ROAD (ARM B)

ARM A IS Somerton Rd (N)
ARM B IS Camp Rd
ARM C IS Lower Heyford Rd (S)

STREAM LABELLING CONVENTION

STREAM A-B CONTAINS TRAFFIC GOING FROM ARM A TO ARM B
STREAM B-AC CONTAINS TRAFFIC GOING FROM ARM B TO ARM A AND TO ARM C
ETC.

 GEOMETRIC DATA

| I | DATA ITEM | I | MINOR ROAD B | I |
|---|------------------------------------|---|----------------|---|
| I | TOTAL MAJOR ROAD CARRIAGEWAY WIDTH | I | (W) 6.00 M. | I |
| I | CENTRAL RESERVE WIDTH | I | (WCR) 0.00 M. | I |
| I | | I | | I |
| I | MAJOR ROAD RIGHT TURN - WIDTH | I | (WC-B) 2.20 M. | I |
| I | - VISIBILITY | I | (VC-B) 89.0 M. | I |
| I | - BLOCKS TRAFFIC | I | YES | I |
| I | | I | | I |
| I | MINOR ROAD - VISIBILITY TO LEFT | I | (VB-C) 30.0 M. | I |
| I | - VISIBILITY TO RIGHT | I | (VB-A) 21.0 M. | I |
| I | - LANE 1 WIDTH | I | (WB-C) - | I |
| I | - LANE 2 WIDTH | I | (WB-A) - | I |
| I | - WIDTH AT 0 M FROM JUNC. | I | 9.00 M. | I |
| I | - WIDTH AT 5 M FROM JUNC. | I | 2.80 M. | I |
| I | - WIDTH AT 10 M FROM JUNC. | I | 2.75 M. | I |
| I | - WIDTH AT 15 M FROM JUNC. | I | 2.75 M. | I |
| I | - WIDTH AT 20 M FROM JUNC. | I | 2.75 M. | I |
| I | - LENGTH OF FLARED SECTION | I | DERIVED: 0 PCU | I |

 .SLOPES AND INTERCEPT

(NB:Streams may be combined, in which case capacity will be adjusted)

| I | Intercept For Stream B-C | Slope For Opposing Stream A-C | Slope For Opposing Stream A-B | I |
|---|--------------------------|-------------------------------|-------------------------------|---|
| I | 586.12 | 0.23 | 0.09 | I |

| I | Intercept For Stream B-A | Slope For Opposing Stream A-C | Slope For Opposing Stream A-B | Slope For Opposing Stream C-A | Slope For Opposing Stream C-B | I |
|---|--------------------------|-------------------------------|-------------------------------|-------------------------------|-------------------------------|---|
| I | 457.77 | 0.21 | 0.08 | 0.13 | 0.30 | I |

| I | Intercept For Stream C-B | Slope For Opposing Stream A-C | Slope For Opposing Stream A-B | I |
|---|--------------------------|-------------------------------|-------------------------------|---|
| I | 625.50 | 0.24 | 0.24 | I |

NB These values do not allow for any site specific corrections

 TRAFFIC DEMAND DATA

| I | TIME | DEMAND (VEH/MIN) | CAPACITY (VEH/MIN) | DEMAND/ CAPACITY (RFC) | PEDESTRIAN FLOW (PEDS/MIN) | START QUEUE (VEHS) | END QUEUE (VEHS) | DELAY (VEH.MIN/ TIME SEGMENT) | GEOMETRIC DELAY (VEH.MIN/ TIME SEGMENT) | AVERAGE DELAY PER ARRIVING VEHICLE (MIN) | I |
|---|-------------|---------------------|-----------------------|------------------------------|----------------------------------|--------------------------|------------------------|-------------------------------------|---|--|---|
| I | 08.15-08.30 | | | | | | | | | | I |
| I | B-C | 0.70 | 10.42 | 0.067 | | 0.06 | 0.07 | 1.0 | | 0.10 | I |
| I | B-A | 0.24 | 8.59 | 0.028 | | 0.02 | 0.03 | 0.4 | | 0.12 | I |
| I | C-AB | 0.24 | 9.98 | 0.024 | | 0.02 | 0.02 | 0.4 | | 0.10 | I |
| I | A-B | 0.77 | | | | | | | | | I |
| I | A-C | 1.06 | | | | | | | | | I |

| I | TIME | DEMAND (VEH/MIN) | CAPACITY (VEH/MIN) | DEMAND/ CAPACITY (RFC) | PEDESTRIAN FLOW (PEDS/MIN) | START QUEUE (VEHS) | END QUEUE (VEHS) | DELAY (VEH.MIN/ TIME SEGMENT) | GEOMETRIC DELAY (VEH.MIN/ TIME SEGMENT) | AVERAGE DELAY PER ARRIVING VEHICLE (MIN) | I |
|---|-------------|---------------------|-----------------------|------------------------------|----------------------------------|--------------------------|------------------------|-------------------------------------|---|--|---|
| I | 08.30-08.45 | | | | | | | | | | I |
| I | B-C | 0.70 | 10.42 | 0.067 | | 0.07 | 0.07 | 1.1 | | 0.10 | I |
| I | B-A | 0.24 | 8.59 | 0.028 | | 0.03 | 0.03 | 0.4 | | 0.12 | I |
| I | C-AB | 0.24 | 9.98 | 0.024 | | 0.02 | 0.02 | 0.4 | | 0.10 | I |
| I | A-B | 0.77 | | | | | | | | | I |
| I | A-C | 1.06 | | | | | | | | | I |

| I | TIME | DEMAND (VEH/MIN) | CAPACITY (VEH/MIN) | DEMAND/ CAPACITY (RFC) | PEDESTRIAN FLOW (PEDS/MIN) | START QUEUE (VEHS) | END QUEUE (VEHS) | DELAY (VEH.MIN/ TIME SEGMENT) | GEOMETRIC DELAY (VEH.MIN/ TIME SEGMENT) | AVERAGE DELAY PER ARRIVING VEHICLE (MIN) | I |
|---|-------------|---------------------|-----------------------|------------------------------|----------------------------------|--------------------------|------------------------|-------------------------------------|---|--|---|
| I | 08.45-09.00 | | | | | | | | | | I |
| I | B-C | 0.57 | 10.50 | 0.054 | | 0.07 | 0.06 | 0.9 | | 0.10 | I |
| I | B-A | 0.19 | 8.69 | 0.022 | | 0.03 | 0.02 | 0.4 | | 0.12 | I |
| I | C-AB | 0.19 | 10.06 | 0.019 | | 0.02 | 0.02 | 0.3 | | 0.10 | I |
| I | A-B | 0.63 | | | | | | | | | I |
| I | A-C | 0.87 | | | | | | | | | I |

| I | TIME | DEMAND (VEH/MIN) | CAPACITY (VEH/MIN) | DEMAND/ CAPACITY (RFC) | PEDESTRIAN FLOW (PEDS/MIN) | START QUEUE (VEHS) | END QUEUE (VEHS) | DELAY (VEH.MIN/ TIME SEGMENT) | GEOMETRIC DELAY (VEH.MIN/ TIME SEGMENT) | AVERAGE DELAY PER ARRIVING VEHICLE (MIN) | I |
|---|-------------|---------------------|-----------------------|------------------------------|----------------------------------|--------------------------|------------------------|-------------------------------------|---|--|---|
| I | 09.00-09.15 | | | | | | | | | | I |
| I | B-C | 0.48 | 10.56 | 0.045 | | 0.06 | 0.05 | 0.7 | | 0.10 | I |
| I | B-A | 0.16 | 8.76 | 0.019 | | 0.02 | 0.02 | 0.3 | | 0.12 | I |
| I | C-AB | 0.16 | 10.12 | 0.016 | | 0.02 | 0.02 | 0.2 | | 0.10 | I |
| I | A-B | 0.53 | | | | | | | | | I |
| I | A-C | 0.73 | | | | | | | | | I |

QUEUE FOR STREAM B-C

| TIME SEGMENT ENDING | NO. OF VEHICLES IN QUEUE |
|------------------------|--------------------------------|
| 08.00 | 0.0 |
| 08.15 | 0.1 |
| 08.30 | 0.1 |
| 08.45 | 0.1 |
| 09.00 | 0.1 |
| 09.15 | 0.0 |

QUEUE FOR STREAM B-A

| TIME SEGMENT ENDING | NO. OF VEHICLES IN QUEUE |
|------------------------|--------------------------------|
| 08.00 | 0.0 |
| 08.15 | 0.0 |
| 08.30 | 0.0 |
| 08.45 | 0.0 |
| 09.00 | 0.0 |
| 09.15 | 0.0 |

QUEUE FOR STREAM C-AB

| TIME SEGMENT ENDING | NO. OF VEHICLES IN QUEUE |
|---------------------|--------------------------|
| 08.00 | 0.0 |
| 08.15 | 0.0 |
| 08.30 | 0.0 |
| 08.45 | 0.0 |
| 09.00 | 0.0 |
| 09.15 | 0.0 |

QUEUEING DELAY INFORMATION OVER WHOLE PERIOD

| I | STREAM | I | TOTAL DEMAND | I | * QUEUEING * * DELAY * | I | * INCLUSIVE QUEUEING * * DELAY * | I |
|---|--------|---|--------------|---|---------------------------|---|-------------------------------------|---|
| I | I | I | (VEH) | I | (MIN) | I | (MIN) | I |
| I | I | I | (VEH/H) | I | (MIN/VEH) | I | (MIN/VEH) | I |
| I | B-C | I | 52.3 | I | 34.9 | I | 5.3 | I |
| I | B-A | I | 17.9 | I | 11.9 | I | 2.1 | I |
| I | C-AB | I | 17.9 | I | 11.9 | I | 1.8 | I |
| I | A-B | I | 57.8 | I | 38.5 | I | | I |
| I | A-C | I | 79.8 | I | 53.2 | I | | I |
| I | ALL | I | 273.9 | I | 182.6 | I | 9.2 | I |

* DELAY IS THAT OCCURRING ONLY WITHIN THE TIME PERIOD .
 * INCLUSIVE DELAY INCLUDES DELAY SUFFERED BY VEHICLES WHICH ARE STILL QUEUEING AFTER THE END OF THE TIME PERIOD.
 * THESE WILL ONLY BE SIGNIFICANTLY DIFFERENT IF THERE IS A LARGE QUEUE REMAINING AT THE END OF THE TIME PERIOD.

END OF JOB

===== end of file =====

TRL LIMITED

(C) COPYRIGHT 2006

CAPACITIES, QUEUES, AND DELAYS AT 3 OR 4-ARM MAJOR/MINOR PRIORITY JUNCTIONS

PICADY 5.0 ANALYSIS PROGRAM
RELEASE 3.0 (JUNE 2006)

ADAPTED FROM PICADY/3 WHICH IS CROWN COPYRIGHT
BY PERMISSION OF THE CONTROLLER OF HMSO

FOR SALES AND DISTRIBUTION INFORMATION,
PROGRAM ADVICE AND MAINTENANCE CONTACT:
TRL SOFTWARE BUREAU
TEL: CROWTHORNE (01344) 770758, FAX: 770864
EMAIL: SoftwareBureau@trl.co.uk

THE USER OF THIS COMPUTER PROGRAM FOR THE SOLUTION OF AN ENGINEERING PROBLEM IS
IN NO WAY RELIEVED OF HIS RESPONSIBILITY FOR THE CORRECTNESS OF THE SOLUTION

Run with file:-

"J:\120000\120669-00\4 Internal Project Data\4-04 Calculations\4-04-06 Junction Analysis\Picady\
Site 12. Somerton Rd - Camp Rd\2006 Base\PM\Site 12. Camp Rd - Somerton Rd 2006 Base PM.vpi"
(drive-on-the-left) at 11:04:02 on Wednesday, 8 August 2007

RUN INFORMATION

RUN TITLE: Site 12. Camp Road - Somerton Rd 2006 Base PM
LOCATION: Oxfordshire
DATE: 09/11/06
CLIENT: North Oxfordshire Consortium
ENUMERATOR: Chris.Morris [MCCPC062011]
JOB NUMBER: 120669
STATUS: TIA
DESCRIPTION:

.MAJOR/MINOR JUNCTION CAPACITY AND DELAY

INPUT DATA

MAJOR ROAD (ARM C) ----- MAJOR ROAD (ARM A)
I
I
I
I
I
I
MINOR ROAD (ARM B)

ARM A IS Somerton Rd (N)
ARM B IS Camp Rd
ARM C IS Lower Heyford Rd (S)

STREAM LABELLING CONVENTION

STREAM A-B CONTAINS TRAFFIC GOING FROM ARM A TO ARM B
STREAM B-AC CONTAINS TRAFFIC GOING FROM ARM B TO ARM A AND TO ARM C
ETC.

 GEOMETRIC DATA

| I | DATA ITEM | I | MINOR ROAD B | I |
|---|------------------------------------|---|----------------|---|
| I | TOTAL MAJOR ROAD CARRIAGEWAY WIDTH | I | (W) 6.00 M. | I |
| I | CENTRAL RESERVE WIDTH | I | (WCR) 0.00 M. | I |
| I | | I | | I |
| I | MAJOR ROAD RIGHT TURN - WIDTH | I | (WC-B) 2.20 M. | I |
| I | - VISIBILITY | I | (VC-B) 89.0 M. | I |
| I | - BLOCKS TRAFFIC | I | YES | I |
| I | | I | | I |
| I | MINOR ROAD - VISIBILITY TO LEFT | I | (VB-C) 30.0 M. | I |
| I | - VISIBILITY TO RIGHT | I | (VB-A) 21.0 M. | I |
| I | - LANE 1 WIDTH | I | (WB-C) - | I |
| I | - LANE 2 WIDTH | I | (WB-A) - | I |
| I | - WIDTH AT 0 M FROM JUNC. | I | 9.00 M. | I |
| I | - WIDTH AT 5 M FROM JUNC. | I | 2.80 M. | I |
| I | - WIDTH AT 10 M FROM JUNC. | I | 2.75 M. | I |
| I | - WIDTH AT 15 M FROM JUNC. | I | 2.75 M. | I |
| I | - WIDTH AT 20 M FROM JUNC. | I | 2.75 M. | I |
| I | - LENGTH OF FLARED SECTION | I | DERIVED: 0 PCU | I |

 .SLOPES AND INTERCEPT

(NB:Streams may be combined, in which case capacity will be adjusted)

| I | Intercept For Stream B-C | Slope For Opposing Stream A-C | Slope For Opposing Stream A-B | I |
|---|--------------------------|-------------------------------|-------------------------------|---|
| I | 586.12 | 0.23 | 0.09 | I |

| I | Intercept For Stream B-A | Slope For Opposing Stream A-C | Slope For Opposing Stream A-B | Slope For Opposing Stream C-A | Slope For Opposing Stream C-B | I |
|---|--------------------------|-------------------------------|-------------------------------|-------------------------------|-------------------------------|---|
| I | 457.77 | 0.21 | 0.08 | 0.13 | 0.30 | I |

| I | Intercept For Stream C-B | Slope For Opposing Stream A-C | Slope For Opposing Stream A-B | I |
|---|--------------------------|-------------------------------|-------------------------------|---|
| I | 625.50 | 0.24 | 0.24 | I |

NB These values do not allow for any site specific corrections

 TRAFFIC DEMAND DATA

| I | TIME | DEMAND (VEH/MIN) | CAPACITY (VEH/MIN) | DEMAND/ CAPACITY (RFC) | PEDESTRIAN FLOW (PEDS/MIN) | START QUEUE (VEHS) | END QUEUE (VEHS) | DELAY (VEH.MIN/ TIME SEGMENT) | GEOMETRIC DELAY (VEH.MIN/ TIME SEGMENT) | AVERAGE DELAY PER ARRIVING VEHICLE (MIN) | I |
|---|-------------|---------------------|-----------------------|------------------------------|----------------------------------|--------------------------|------------------------|-------------------------------------|---|--|---|
| I | 17.15-17.30 | | | | | | | | | | I |
| I | B-C | 0.42 | 11.19 | 0.038 | | 0.03 | 0.04 | 0.6 | | 0.09 | I |
| I | B-A | 0.77 | 8.04 | 0.096 | | 0.08 | 0.10 | 1.5 | | 0.14 | I |
| I | C-AB | 0.11 | 10.12 | 0.011 | | 0.01 | 0.01 | 0.2 | | 0.10 | I |
| I | A-B | 0.75 | | | | | | | | | I |
| I | A-C | 0.51 | | | | | | | | | I |

| I | TIME | DEMAND (VEH/MIN) | CAPACITY (VEH/MIN) | DEMAND/ CAPACITY (RFC) | PEDESTRIAN FLOW (PEDS/MIN) | START QUEUE (VEHS) | END QUEUE (VEHS) | DELAY (VEH.MIN/ TIME SEGMENT) | GEOMETRIC DELAY (VEH.MIN/ TIME SEGMENT) | AVERAGE DELAY PER ARRIVING VEHICLE (MIN) | I |
|---|-------------|---------------------|-----------------------|------------------------------|----------------------------------|--------------------------|------------------------|-------------------------------------|---|--|---|
| I | 17.30-17.45 | | | | | | | | | | I |
| I | B-C | 0.42 | 11.19 | 0.038 | | 0.04 | 0.04 | 0.6 | | 0.09 | I |
| I | B-A | 0.77 | 8.04 | 0.096 | | 0.10 | 0.11 | 1.6 | | 0.14 | I |
| I | C-AB | 0.11 | 10.12 | 0.011 | | 0.01 | 0.01 | 0.2 | | 0.10 | I |
| I | A-B | 0.75 | | | | | | | | | I |
| I | A-C | 0.51 | | | | | | | | | I |

| I | TIME | DEMAND (VEH/MIN) | CAPACITY (VEH/MIN) | DEMAND/ CAPACITY (RFC) | PEDESTRIAN FLOW (PEDS/MIN) | START QUEUE (VEHS) | END QUEUE (VEHS) | DELAY (VEH.MIN/ TIME SEGMENT) | GEOMETRIC DELAY (VEH.MIN/ TIME SEGMENT) | AVERAGE DELAY PER ARRIVING VEHICLE (MIN) | I |
|---|-------------|---------------------|-----------------------|------------------------------|----------------------------------|--------------------------|------------------------|-------------------------------------|---|--|---|
| I | 17.45-18.00 | | | | | | | | | | I |
| I | B-C | 0.34 | 11.28 | 0.031 | | 0.04 | 0.03 | 0.5 | | 0.09 | I |
| I | B-A | 0.63 | 8.12 | 0.077 | | 0.11 | 0.08 | 1.3 | | 0.13 | I |
| I | C-AB | 0.09 | 10.17 | 0.009 | | 0.01 | 0.01 | 0.1 | | 0.10 | I |
| I | A-B | 0.61 | | | | | | | | | I |
| I | A-C | 0.42 | | | | | | | | | I |

| I | TIME | DEMAND (VEH/MIN) | CAPACITY (VEH/MIN) | DEMAND/ CAPACITY (RFC) | PEDESTRIAN FLOW (PEDS/MIN) | START QUEUE (VEHS) | END QUEUE (VEHS) | DELAY (VEH.MIN/ TIME SEGMENT) | GEOMETRIC DELAY (VEH.MIN/ TIME SEGMENT) | AVERAGE DELAY PER ARRIVING VEHICLE (MIN) | I |
|---|-------------|---------------------|-----------------------|------------------------------|----------------------------------|--------------------------|------------------------|-------------------------------------|---|--|---|
| I | 18.00-18.15 | | | | | | | | | | I |
| I | B-C | 0.29 | 11.34 | 0.025 | | 0.03 | 0.03 | 0.4 | | 0.09 | I |
| I | B-A | 0.53 | 8.18 | 0.064 | | 0.08 | 0.07 | 1.1 | | 0.13 | I |
| I | C-AB | 0.08 | 10.22 | 0.007 | | 0.01 | 0.01 | 0.1 | | 0.10 | I |
| I | A-B | 0.51 | | | | | | | | | I |
| I | A-C | 0.35 | | | | | | | | | I |

QUEUE FOR STREAM B-C

| TIME SEGMENT ENDING | NO. OF VEHICLES IN QUEUE |
|------------------------|--------------------------------|
| 17.00 | 0.0 |
| 17.15 | 0.0 |
| 17.30 | 0.0 |
| 17.45 | 0.0 |
| 18.00 | 0.0 |
| 18.15 | 0.0 |

QUEUE FOR STREAM B-A

| TIME SEGMENT ENDING | NO. OF VEHICLES IN QUEUE |
|------------------------|--------------------------------|
| 17.00 | 0.1 |
| 17.15 | 0.1 |
| 17.30 | 0.1 |
| 17.45 | 0.1 |
| 18.00 | 0.1 |
| 18.15 | 0.1 |

QUEUE FOR STREAM C-AB

| TIME SEGMENT ENDING | NO. OF VEHICLES IN QUEUE |
|---------------------|--------------------------|
| 17.00 | 0.0 |
| 17.15 | 0.0 |
| 17.30 | 0.0 |
| 17.45 | 0.0 |
| 18.00 | 0.0 |
| 18.15 | 0.0 |

QUEUEING DELAY INFORMATION OVER WHOLE PERIOD

| I | STREAM | I | TOTAL DEMAND | I | * QUEUEING * | I | * INCLUSIVE QUEUEING * | I |
|---|--------|---|--------------|---|--------------|---|------------------------|---|
| I | I | I | (VEH) | I | (MIN) | I | (MIN) | I |
| I | I | I | (VEH/H) | I | (MIN/VEH) | I | (MIN/VEH) | I |
| I | B-C | I | 31.7 | I | 2.9 | I | 2.9 | I |
| I | B-A | I | 57.8 | I | 7.7 | I | 7.7 | I |
| I | C-AB | I | 8.3 | I | 0.8 | I | 0.8 | I |
| I | A-B | I | 56.4 | I | | I | | I |
| I | A-C | I | 38.5 | I | | I | | I |
| I | ALL | I | 293.2 | I | 11.4 | I | 11.4 | I |

* DELAY IS THAT OCCURRING ONLY WITHIN THE TIME PERIOD .
 * INCLUSIVE DELAY INCLUDES DELAY SUFFERED BY VEHICLES WHICH ARE STILL QUEUEING AFTER THE END OF THE TIME PERIOD.
 * THESE WILL ONLY BE SIGNIFICANTLY DIFFERENT IF THERE IS A LARGE QUEUE REMAINING AT THE END OF THE TIME PERIOD.

END OF JOB

===== end of file =====

TRL LIMITED

(C) COPYRIGHT 2006

CAPACITIES, QUEUES, AND DELAYS AT 3 OR 4-ARM MAJOR/MINOR PRIORITY JUNCTIONS

PICADY 5.0 ANALYSIS PROGRAM
RELEASE 3.0 (JUNE 2006)

ADAPTED FROM PICADY/3 WHICH IS CROWN COPYRIGHT
BY PERMISSION OF THE CONTROLLER OF HMSO

FOR SALES AND DISTRIBUTION INFORMATION,
PROGRAM ADVICE AND MAINTENANCE CONTACT:
TRL SOFTWARE BUREAU
TEL: CROWTHORNE (01344) 770758, FAX: 770864
EMAIL: SoftwareBureau@trl.co.uk

THE USER OF THIS COMPUTER PROGRAM FOR THE SOLUTION OF AN ENGINEERING PROBLEM IS
IN NO WAY RELIEVED OF HIS RESPONSIBILITY FOR THE CORRECTNESS OF THE SOLUTION

Run with file:-

"J:\120000\120669-00\4 Internal Project Data\4-04 Calculations\4-04-06 Junction Analysis\Picady\
Site 12. Somerton Rd - Camp Rd\2013 Base\AM\Site 12. Camp Rd - Somerton Rd 2013 Base AM.vpi"
(drive-on-the-left) at 11:14:20 on Wednesday, 8 August 2007

RUN INFORMATION

RUN TITLE: Site 12. Camp Road - Somerton Rd 2013 Base AM
LOCATION: Oxfordshire
DATE: 08/08/07
CLIENT: North Oxfordshire Consortium
ENUMERATOR: Ian Clarke
JOB NUMBER: 120669
STATUS: TIA
DESCRIPTION:

.MAJOR/MINOR JUNCTION CAPACITY AND DELAY

INPUT DATA

MAJOR ROAD (ARM C) ----- MAJOR ROAD (ARM A)
I
I
I
I
I
I
I
MINOR ROAD (ARM B)

ARM A IS Somerton Rd (N)
ARM B IS Camp Rd
ARM C IS Lower Heyford Rd (S)

STREAM LABELLING CONVENTION

STREAM A-B CONTAINS TRAFFIC GOING FROM ARM A TO ARM B
STREAM B-AC CONTAINS TRAFFIC GOING FROM ARM B TO ARM A AND TO ARM C
ETC.

 GEOMETRIC DATA

| I | DATA ITEM | I | MINOR ROAD B | I |
|---|------------------------------------|------------|--------------|---|
| I | TOTAL MAJOR ROAD CARRIAGEWAY WIDTH | I (W) | 6.00 M. | I |
| I | CENTRAL RESERVE WIDTH | I (WCR) | 0.00 M. | I |
| I | | I | | I |
| I | MAJOR ROAD RIGHT TURN - WIDTH | I (WC-B) | 2.20 M. | I |
| I | - VISIBILITY | I (VC-B) | 89.0 M. | I |
| I | - BLOCKS TRAFFIC | I | YES | I |
| I | | I | | I |
| I | MINOR ROAD - VISIBILITY TO LEFT | I (VB-C) | 30.0 M. | I |
| I | - VISIBILITY TO RIGHT | I (VB-A) | 21.0 M. | I |
| I | - LANE 1 WIDTH | I (WB-C) | - | I |
| I | - LANE 2 WIDTH | I (WB-A) | - | I |
| I | - WIDTH AT 0 M FROM JUNC. | I | 9.00 M. | I |
| I | - WIDTH AT 5 M FROM JUNC. | I | 2.80 M. | I |
| I | - WIDTH AT 10 M FROM JUNC. | I | 2.75 M. | I |
| I | - WIDTH AT 15 M FROM JUNC. | I | 2.75 M. | I |
| I | - WIDTH AT 20 M FROM JUNC. | I | 2.75 M. | I |
| I | - LENGTH OF FLARED SECTION | I DERIVED: | 0 PCU | I |

 .SLOPES AND INTERCEPT

(NB:Streams may be combined, in which case capacity will be adjusted)

| I | Intercept For Stream B-C | Slope For Opposing Stream A-C | Slope For Opposing Stream A-B | I |
|---|--------------------------|-------------------------------|-------------------------------|---|
| I | 586.12 | 0.23 | 0.09 | I |

| I | Intercept For Stream B-A | Slope For Opposing Stream A-C | Slope For Opposing Stream A-B | Slope For Opposing Stream C-A | Slope For Opposing Stream C-B | I |
|---|--------------------------|-------------------------------|-------------------------------|-------------------------------|-------------------------------|---|
| I | 457.77 | 0.21 | 0.08 | 0.13 | 0.30 | I |

| I | Intercept For Stream C-B | Slope For Opposing Stream A-C | Slope For Opposing Stream A-B | I |
|---|--------------------------|-------------------------------|-------------------------------|---|
| I | 625.50 | 0.24 | 0.24 | I |

NB These values do not allow for any site specific corrections

 TRAFFIC DEMAND DATA

| I | TIME | DEMAND (VEH/MIN) | CAPACITY (VEH/MIN) | DEMAND/ CAPACITY (RFC) | PEDESTRIAN FLOW (PEDS/MIN) | START QUEUE (VEHS) | END QUEUE (VEHS) | DELAY (VEH.MIN/ TIME SEGMENT) | GEOMETRIC DELAY (VEH.MIN/ TIME SEGMENT) | AVERAGE DELAY PER ARRIVING VEHICLE (MIN) | I |
|---|-------------|---------------------|-----------------------|------------------------------|----------------------------------|--------------------------|------------------------|-------------------------------------|---|--|---|
| I | 08.15-08.30 | | | | | | | | | | I |
| I | B-C | 0.79 | 10.37 | 0.076 | | 0.07 | 0.08 | 1.2 | | 0.10 | I |
| I | B-A | 0.26 | 8.53 | 0.030 | | 0.02 | 0.03 | 0.5 | | 0.12 | I |
| I | C-AB | 0.26 | 9.92 | 0.026 | | 0.02 | 0.03 | 0.4 | | 0.10 | I |
| I | A-B | 0.88 | | | | | | | | | I |
| I | A-C | 1.19 | | | | | | | | | I |

| I | TIME | DEMAND (VEH/MIN) | CAPACITY (VEH/MIN) | DEMAND/ CAPACITY (RFC) | PEDESTRIAN FLOW (PEDS/MIN) | START QUEUE (VEHS) | END QUEUE (VEHS) | DELAY (VEH.MIN/ TIME SEGMENT) | GEOMETRIC DELAY (VEH.MIN/ TIME SEGMENT) | AVERAGE DELAY PER ARRIVING VEHICLE (MIN) | I |
|---|-------------|---------------------|-----------------------|------------------------------|----------------------------------|--------------------------|------------------------|-------------------------------------|---|--|---|
| I | 08.30-08.45 | | | | | | | | | | I |
| I | B-C | 0.79 | 10.37 | 0.076 | | 0.08 | 0.08 | 1.2 | | 0.10 | I |
| I | B-A | 0.26 | 8.53 | 0.030 | | 0.03 | 0.03 | 0.5 | | 0.12 | I |
| I | C-AB | 0.26 | 9.92 | 0.026 | | 0.03 | 0.03 | 0.4 | | 0.10 | I |
| I | A-B | 0.88 | | | | | | | | | I |
| I | A-C | 1.19 | | | | | | | | | I |

| I | TIME | DEMAND (VEH/MIN) | CAPACITY (VEH/MIN) | DEMAND/ CAPACITY (RFC) | PEDESTRIAN FLOW (PEDS/MIN) | START QUEUE (VEHS) | END QUEUE (VEHS) | DELAY (VEH.MIN/ TIME SEGMENT) | GEOMETRIC DELAY (VEH.MIN/ TIME SEGMENT) | AVERAGE DELAY PER ARRIVING VEHICLE (MIN) | I |
|---|-------------|---------------------|-----------------------|------------------------------|----------------------------------|--------------------------|------------------------|-------------------------------------|---|--|---|
| I | 08.45-09.00 | | | | | | | | | | I |
| I | B-C | 0.64 | 10.46 | 0.062 | | 0.08 | 0.07 | 1.0 | | 0.10 | I |
| I | B-A | 0.21 | 8.64 | 0.024 | | 0.03 | 0.03 | 0.4 | | 0.12 | I |
| I | C-AB | 0.21 | 10.01 | 0.021 | | 0.03 | 0.02 | 0.3 | | 0.10 | I |
| I | A-B | 0.72 | | | | | | | | | I |
| I | A-C | 0.97 | | | | | | | | | I |

| I | TIME | DEMAND (VEH/MIN) | CAPACITY (VEH/MIN) | DEMAND/ CAPACITY (RFC) | PEDESTRIAN FLOW (PEDS/MIN) | START QUEUE (VEHS) | END QUEUE (VEHS) | DELAY (VEH.MIN/ TIME SEGMENT) | GEOMETRIC DELAY (VEH.MIN/ TIME SEGMENT) | AVERAGE DELAY PER ARRIVING VEHICLE (MIN) | I |
|---|-------------|---------------------|-----------------------|------------------------------|----------------------------------|--------------------------|------------------------|-------------------------------------|---|--|---|
| I | 09.00-09.15 | | | | | | | | | | I |
| I | B-C | 0.54 | 10.52 | 0.051 | | 0.07 | 0.05 | 0.8 | | 0.10 | I |
| I | B-A | 0.18 | 8.72 | 0.020 | | 0.03 | 0.02 | 0.3 | | 0.12 | I |
| I | C-AB | 0.18 | 10.08 | 0.017 | | 0.02 | 0.02 | 0.3 | | 0.10 | I |
| I | A-B | 0.60 | | | | | | | | | I |
| I | A-C | 0.82 | | | | | | | | | I |

QUEUE FOR STREAM B-C

| TIME SEGMENT ENDING | NO. OF VEHICLES IN QUEUE |
|------------------------|--------------------------------|
| 08.00 | 0.1 |
| 08.15 | 0.1 |
| 08.30 | 0.1 |
| 08.45 | 0.1 |
| 09.00 | 0.1 |
| 09.15 | 0.1 |

QUEUE FOR STREAM B-A

| TIME SEGMENT ENDING | NO. OF VEHICLES IN QUEUE |
|------------------------|--------------------------------|
| 08.00 | 0.0 |
| 08.15 | 0.0 |
| 08.30 | 0.0 |
| 08.45 | 0.0 |
| 09.00 | 0.0 |
| 09.15 | 0.0 |

QUEUE FOR STREAM C-AB

| TIME SEGMENT ENDING | NO. OF VEHICLES IN QUEUE |
|---------------------|--------------------------|
| 08.00 | 0.0 |
| 08.15 | 0.0 |
| 08.30 | 0.0 |
| 08.45 | 0.0 |
| 09.00 | 0.0 |
| 09.15 | 0.0 |

QUEUEING DELAY INFORMATION OVER WHOLE PERIOD

| I | STREAM | I | TOTAL DEMAND | I | * QUEUEING * * DELAY * | I | * INCLUSIVE QUEUEING * * DELAY * | I | | |
|---|--------|-------|--------------|---|---------------------------|-----------|-------------------------------------|-------|-----------|---|
| I | I | (VEH) | (VEH/H) | I | (MIN) | (MIN/VEH) | I | (MIN) | (MIN/VEH) | I |
| I | B-C | I | 59.2 | I | 39.5 | I | 6.0 | I | 0.10 | I |
| I | B-A | I | 19.3 | I | 12.8 | I | 2.3 | I | 0.12 | I |
| I | C-AB | I | 19.3 | I | 12.8 | I | 2.0 | I | 0.10 | I |
| I | A-B | I | 66.1 | I | 44.0 | I | | I | | I |
| I | A-C | I | 89.5 | I | 59.6 | I | | I | | I |
| I | ALL | I | 306.9 | I | 204.6 | I | 10.3 | I | 0.03 | I |

* DELAY IS THAT OCCURRING ONLY WITHIN THE TIME PERIOD .
 * INCLUSIVE DELAY INCLUDES DELAY SUFFERED BY VEHICLES WHICH ARE STILL QUEUEING AFTER THE END OF THE TIME PERIOD.
 * THESE WILL ONLY BE SIGNIFICANTLY DIFFERENT IF THERE IS A LARGE QUEUE REMAINING AT THE END OF THE TIME PERIOD.

END OF JOB

===== end of file =====

TRL LIMITED

(C) COPYRIGHT 2006

CAPACITIES, QUEUES, AND DELAYS AT 3 OR 4-ARM MAJOR/MINOR PRIORITY JUNCTIONS

PICADY 5.0 ANALYSIS PROGRAM
RELEASE 3.0 (JUNE 2006)

ADAPTED FROM PICADY/3 WHICH IS CROWN COPYRIGHT
BY PERMISSION OF THE CONTROLLER OF HMSO

FOR SALES AND DISTRIBUTION INFORMATION,
PROGRAM ADVICE AND MAINTENANCE CONTACT:
TRL SOFTWARE BUREAU
TEL: CROWTHORNE (01344) 770758, FAX: 770864
EMAIL: SoftwareBureau@trl.co.uk

THE USER OF THIS COMPUTER PROGRAM FOR THE SOLUTION OF AN ENGINEERING PROBLEM IS
IN NO WAY RELIEVED OF HIS RESPONSIBILITY FOR THE CORRECTNESS OF THE SOLUTION

Run with file:-

"J:\120000\120669-00\4 Internal Project Data\4-04 Calculations\4-04-06 Junction Analysis\Picady\
Site 12. Somerton Rd - Camp Rd\2013 Base\PM\Site 12. Camp Rd - Somerton Rd 2013 Base PM.vpi"
(drive-on-the-left) at 11:18:13 on Wednesday, 8 August 2007

RUN INFORMATION

RUN TITLE: Site 12. Camp Road - Somerton Rd 2013 Base PM
LOCATION: Oxfordshire
DATE: 08/08/07
CLIENT: North Oxfordshire Consortium
ENUMERATOR: Ian Clarke
JOB NUMBER: 120669
STATUS: TIA
DESCRIPTION:

.MAJOR/MINOR JUNCTION CAPACITY AND DELAY

INPUT DATA

MAJOR ROAD (ARM C) ----- MAJOR ROAD (ARM A)
I
I
I
I
I
I
I
MINOR ROAD (ARM B)

ARM A IS Somerton Rd (N)
ARM B IS Camp Rd
ARM C IS Lower Heyford Rd (S)

STREAM LABELLING CONVENTION

STREAM A-B CONTAINS TRAFFIC GOING FROM ARM A TO ARM B
STREAM B-AC CONTAINS TRAFFIC GOING FROM ARM B TO ARM A AND TO ARM C
ETC.

 GEOMETRIC DATA

| I | DATA ITEM | I | MINOR ROAD B | I |
|---|------------------------------------|---|----------------|---|
| I | TOTAL MAJOR ROAD CARRIAGEWAY WIDTH | I | (W) 6.00 M. | I |
| I | CENTRAL RESERVE WIDTH | I | (WCR) 0.00 M. | I |
| I | | I | | I |
| I | MAJOR ROAD RIGHT TURN - WIDTH | I | (WC-B) 2.20 M. | I |
| I | - VISIBILITY | I | (VC-B) 89.0 M. | I |
| I | - BLOCKS TRAFFIC | I | YES | I |
| I | | I | | I |
| I | MINOR ROAD - VISIBILITY TO LEFT | I | (VB-C) 30.0 M. | I |
| I | - VISIBILITY TO RIGHT | I | (VB-A) 21.0 M. | I |
| I | - LANE 1 WIDTH | I | (WB-C) - | I |
| I | - LANE 2 WIDTH | I | (WB-A) - | I |
| I | - WIDTH AT 0 M FROM JUNC. | I | 9.00 M. | I |
| I | - WIDTH AT 5 M FROM JUNC. | I | 2.80 M. | I |
| I | - WIDTH AT 10 M FROM JUNC. | I | 2.75 M. | I |
| I | - WIDTH AT 15 M FROM JUNC. | I | 2.75 M. | I |
| I | - WIDTH AT 20 M FROM JUNC. | I | 2.75 M. | I |
| I | - LENGTH OF FLARED SECTION | I | DERIVED: 0 PCU | I |

 .SLOPES AND INTERCEPT

(NB:Streams may be combined, in which case capacity will be adjusted)

| I | Intercept For Stream B-C | Slope For Opposing Stream A-C | Slope For Opposing Stream A-B | I |
|---|--------------------------|-------------------------------|-------------------------------|---|
| I | 586.12 | 0.23 | 0.09 | I |

| I | Intercept For Stream B-A | Slope For Opposing Stream A-C | Slope For Opposing Stream A-B | Slope For Opposing Stream C-A | Slope For Opposing Stream C-B | I |
|---|--------------------------|-------------------------------|-------------------------------|-------------------------------|-------------------------------|---|
| I | 457.77 | 0.21 | 0.08 | 0.13 | 0.30 | I |

| I | Intercept For Stream C-B | Slope For Opposing Stream A-C | Slope For Opposing Stream A-B | I |
|---|--------------------------|-------------------------------|-------------------------------|---|
| I | 625.50 | 0.24 | 0.24 | I |

NB These values do not allow for any site specific corrections

 TRAFFIC DEMAND DATA

| I | TIME | DEMAND (VEH/MIN) | CAPACITY (VEH/MIN) | DEMAND/ CAPACITY (RFC) | PEDESTRIAN FLOW (PEDS/MIN) | START QUEUE (VEHS) | END QUEUE (VEHS) | DELAY (VEH.MIN/ TIME SEGMENT) | GEOMETRIC DELAY (VEH.MIN/ TIME SEGMENT) | AVERAGE DELAY PER ARRIVING VEHICLE (MIN) | I |
|---|-------------|---------------------|-----------------------|------------------------------|----------------------------------|--------------------------|------------------------|-------------------------------------|---|--|---|
| I | 17.15-17.30 | | | | | | | | | | I |
| I | B-C | 0.48 | 11.11 | 0.043 | | 0.04 | 0.04 | 0.7 | | 0.09 | I |
| I | B-A | 0.88 | 7.99 | 0.110 | | 0.10 | 0.12 | 1.8 | | 0.14 | I |
| I | C-AB | 0.13 | 10.07 | 0.013 | | 0.01 | 0.01 | 0.2 | | 0.10 | I |
| I | A-B | 0.86 | | | | | | | | | I |
| I | A-C | 0.59 | | | | | | | | | I |

| I | TIME | DEMAND (VEH/MIN) | CAPACITY (VEH/MIN) | DEMAND/ CAPACITY (RFC) | PEDESTRIAN FLOW (PEDS/MIN) | START QUEUE (VEHS) | END QUEUE (VEHS) | DELAY (VEH.MIN/ TIME SEGMENT) | GEOMETRIC DELAY (VEH.MIN/ TIME SEGMENT) | AVERAGE DELAY PER ARRIVING VEHICLE (MIN) | I |
|---|-------------|---------------------|-----------------------|------------------------------|----------------------------------|--------------------------|------------------------|-------------------------------------|---|--|---|
| I | 17.30-17.45 | | | | | | | | | | I |
| I | B-C | 0.48 | 11.11 | 0.043 | | 0.04 | 0.04 | 0.7 | | 0.09 | I |
| I | B-A | 0.88 | 7.99 | 0.110 | | 0.12 | 0.12 | 1.8 | | 0.14 | I |
| I | C-AB | 0.13 | 10.07 | 0.013 | | 0.01 | 0.01 | 0.2 | | 0.10 | I |
| I | A-B | 0.86 | | | | | | | | | I |
| I | A-C | 0.59 | | | | | | | | | I |

| I | TIME | DEMAND (VEH/MIN) | CAPACITY (VEH/MIN) | DEMAND/ CAPACITY (RFC) | PEDESTRIAN FLOW (PEDS/MIN) | START QUEUE (VEHS) | END QUEUE (VEHS) | DELAY (VEH.MIN/ TIME SEGMENT) | GEOMETRIC DELAY (VEH.MIN/ TIME SEGMENT) | AVERAGE DELAY PER ARRIVING VEHICLE (MIN) | I |
|---|-------------|---------------------|-----------------------|------------------------------|----------------------------------|--------------------------|------------------------|-------------------------------------|---|--|---|
| I | 17.45-18.00 | | | | | | | | | | I |
| I | B-C | 0.39 | 11.22 | 0.035 | | 0.04 | 0.04 | 0.6 | | 0.09 | I |
| I | B-A | 0.72 | 8.07 | 0.089 | | 0.12 | 0.10 | 1.5 | | 0.14 | I |
| I | C-AB | 0.10 | 10.14 | 0.010 | | 0.01 | 0.01 | 0.2 | | 0.10 | I |
| I | A-B | 0.70 | | | | | | | | | I |
| I | A-C | 0.48 | | | | | | | | | I |

| I | TIME | DEMAND (VEH/MIN) | CAPACITY (VEH/MIN) | DEMAND/ CAPACITY (RFC) | PEDESTRIAN FLOW (PEDS/MIN) | START QUEUE (VEHS) | END QUEUE (VEHS) | DELAY (VEH.MIN/ TIME SEGMENT) | GEOMETRIC DELAY (VEH.MIN/ TIME SEGMENT) | AVERAGE DELAY PER ARRIVING VEHICLE (MIN) | I |
|---|-------------|---------------------|-----------------------|------------------------------|----------------------------------|--------------------------|------------------------|-------------------------------------|---|--|---|
| I | 18.00-18.15 | | | | | | | | | | I |
| I | B-C | 0.33 | 11.29 | 0.029 | | 0.04 | 0.03 | 0.5 | | 0.09 | I |
| I | B-A | 0.60 | 8.14 | 0.074 | | 0.10 | 0.08 | 1.2 | | 0.13 | I |
| I | C-AB | 0.09 | 10.18 | 0.009 | | 0.01 | 0.01 | 0.1 | | 0.10 | I |
| I | A-B | 0.59 | | | | | | | | | I |
| I | A-C | 0.40 | | | | | | | | | I |

QUEUE FOR STREAM B-C

| TIME SEGMENT ENDING | NO. OF VEHICLES IN QUEUE |
|------------------------|--------------------------------|
| 17.00 | 0.0 |
| 17.15 | 0.0 |
| 17.30 | 0.0 |
| 17.45 | 0.0 |
| 18.00 | 0.0 |
| 18.15 | 0.0 |

QUEUE FOR STREAM B-A

| TIME SEGMENT ENDING | NO. OF VEHICLES IN QUEUE |
|------------------------|--------------------------------|
| 17.00 | 0.1 |
| 17.15 | 0.1 |
| 17.30 | 0.1 |
| 17.45 | 0.1 |
| 18.00 | 0.1 |
| 18.15 | 0.1 |

QUEUE FOR STREAM C-AB

| TIME SEGMENT ENDING | NO. OF VEHICLES IN QUEUE |
|---------------------|--------------------------|
| 17.00 | 0.0 |
| 17.15 | 0.0 |
| 17.30 | 0.0 |
| 17.45 | 0.0 |
| 18.00 | 0.0 |
| 18.15 | 0.0 |

QUEUEING DELAY INFORMATION OVER WHOLE PERIOD

| I | STREAM | I | TOTAL DEMAND | I | * QUEUEING * * DELAY * | I | * INCLUSIVE QUEUEING * * DELAY * | I | | |
|---|--------|-------|--------------|---|---------------------------|-----------|-------------------------------------|-------|-----------|---|
| I | I | (VEH) | (VEH/H) | I | (MIN) | (MIN/VEH) | I | (MIN) | (MIN/VEH) | I |
| I | B-C | I | 35.8 | I | 23.9 | I | 3.3 | I | 0.09 | I |
| I | B-A | I | 66.1 | I | 44.0 | I | 9.0 | I | 0.14 | I |
| I | C-AB | I | 9.6 | I | 6.4 | I | 1.0 | I | 0.10 | I |
| I | A-B | I | 64.7 | I | 43.1 | I | | I | | I |
| I | A-C | I | 44.0 | I | 29.4 | I | | I | | I |
| I | ALL | I | 333.1 | I | 222.1 | I | 13.2 | I | 0.04 | I |

* DELAY IS THAT OCCURRING ONLY WITHIN THE TIME PERIOD .
 * INCLUSIVE DELAY INCLUDES DELAY SUFFERED BY VEHICLES WHICH ARE STILL QUEUEING AFTER THE END OF THE TIME PERIOD.
 * THESE WILL ONLY BE SIGNIFICANTLY DIFFERENT IF THERE IS A LARGE QUEUE REMAINING AT THE END OF THE TIME PERIOD.

END OF JOB

===== end of file =====

TRL LIMITED

(C) COPYRIGHT 2006

CAPACITIES, QUEUES, AND DELAYS AT 3 OR 4-ARM MAJOR/MINOR PRIORITY JUNCTIONS

PICADY 5.0 ANALYSIS PROGRAM
RELEASE 3.0 (JUNE 2006)

ADAPTED FROM PICADY/3 WHICH IS CROWN COPYRIGHT
BY PERMISSION OF THE CONTROLLER OF HMSO

FOR SALES AND DISTRIBUTION INFORMATION,
PROGRAM ADVICE AND MAINTENANCE CONTACT:

TRL SOFTWARE BUREAU
TEL: CROWTHORNE (01344) 770758, FAX: 770864
EMAIL: SoftwareBureau@trl.co.uk

THE USER OF THIS COMPUTER PROGRAM FOR THE SOLUTION OF AN ENGINEERING PROBLEM IS
IN NO WAY RELIEVED OF HIS RESPONSIBILITY FOR THE CORRECTNESS OF THE SOLUTION

Run with file:-

"J:\120000\120669-00\4 Internal Project Data\4-04 Calculations\4-04-06 Junction Analysis\Picady\
Site 12. Somerton Rd - Camp Rd\2013 Base + Gen\AM\
Site 12. Camp Rd - Somerton Rd 2013 Base + Full Development AM.vpi"
(drive-on-the-left) at 16:57:54 on Tuesday, 31 July 2007

RUN INFORMATION

RUN TITLE: Site 12. Camp Road - Somerton Rd 2013 Base + Full Development AM
LOCATION: Oxfordshire
DATE: 31/07/07
CLIENT: North Oxfordshire Consortium
ENUMERATOR: Ian Clarke
JOB NUMBER: 120669
STATUS: TIA
DESCRIPTION:

.MAJOR/MINOR JUNCTION CAPACITY AND DELAY

INPUT DATA

MAJOR ROAD (ARM C) ----- MAJOR ROAD (ARM A)
I
I
I
I
I
I
MINOR ROAD (ARM B)

ARM A IS Somerton Rd (N)
ARM B IS Camp Rd
ARM C IS Lower Heyford Rd (S)

STREAM LABELLING CONVENTION

STREAM A-B CONTAINS TRAFFIC GOING FROM ARM A TO ARM B
STREAM B-AC CONTAINS TRAFFIC GOING FROM ARM B TO ARM A AND TO ARM C
ETC.

 GEOMETRIC DATA

| I | DATA ITEM | I | MINOR ROAD B | I |
|---|------------------------------------|---|----------------|---|
| I | TOTAL MAJOR ROAD CARRIAGEWAY WIDTH | I | (W) 6.00 M. | I |
| I | CENTRAL RESERVE WIDTH | I | (WCR) 0.00 M. | I |
| I | | I | | I |
| I | MAJOR ROAD RIGHT TURN - WIDTH | I | (WC-B) 2.20 M. | I |
| I | - VISIBILITY | I | (VC-B) 89.0 M. | I |
| I | - BLOCKS TRAFFIC | I | YES | I |
| I | | I | | I |
| I | MINOR ROAD - VISIBILITY TO LEFT | I | (VB-C) 30.0 M. | I |
| I | - VISIBILITY TO RIGHT | I | (VB-A) 21.0 M. | I |
| I | - LANE 1 WIDTH | I | (WB-C) - | I |
| I | - LANE 2 WIDTH | I | (WB-A) - | I |
| I | - WIDTH AT 0 M FROM JUNC. | I | 9.00 M. | I |
| I | - WIDTH AT 5 M FROM JUNC. | I | 2.80 M. | I |
| I | - WIDTH AT 10 M FROM JUNC. | I | 2.75 M. | I |
| I | - WIDTH AT 15 M FROM JUNC. | I | 2.75 M. | I |
| I | - WIDTH AT 20 M FROM JUNC. | I | 2.75 M. | I |
| I | - LENGTH OF FLARED SECTION | I | DERIVED: 0 PCU | I |

 .SLOPES AND INTERCEPT

(NB:Streams may be combined, in which case capacity will be adjusted)

| I | Intercept For Stream B-C | Slope For Opposing Stream A-C | Slope For Opposing Stream A-B | I |
|---|--------------------------|-------------------------------|-------------------------------|---|
| I | 586.12 | 0.23 | 0.09 | I |

| I | Intercept For Stream B-A | Slope For Opposing Stream A-C | Slope For Opposing Stream A-B | Slope For Opposing Stream C-A | Slope For Opposing Stream C-B | I |
|---|--------------------------|-------------------------------|-------------------------------|-------------------------------|-------------------------------|---|
| I | 457.77 | 0.21 | 0.08 | 0.13 | 0.30 | I |

| I | Intercept For Stream C-B | Slope For Opposing Stream A-C | Slope For Opposing Stream A-B | I |
|---|--------------------------|-------------------------------|-------------------------------|---|
| I | 625.50 | 0.24 | 0.24 | I |

NB These values do not allow for any site specific corrections

 TRAFFIC DEMAND DATA

| I | TIME | DEMAND (VEH/MIN) | CAPACITY (VEH/MIN) | DEMAND/ CAPACITY (RFC) | PEDESTRIAN FLOW (PEDS/MIN) | START QUEUE (VEHS) | END QUEUE (VEHS) | DELAY (VEH.MIN/ TIME SEGMENT) | GEOMETRIC DELAY (VEH.MIN/ TIME SEGMENT) | AVERAGE DELAY PER ARRIVING VEHICLE (MIN) | I |
|---|-------------|---------------------|-----------------------|------------------------------|----------------------------------|--------------------------|------------------------|-------------------------------------|---|--|---|
| I | 08.15-08.30 | | | | | | | | | | I |
| I | B-C | 1.76 | 10.07 | 0.175 | | 0.16 | 0.21 | 3.1 | | 0.12 | I |
| I | B-A | 2.40 | 7.23 | 0.332 | | 0.35 | 0.49 | 7.0 | | 0.21 | I |
| I | C-AB | 1.58 | 9.30 | 0.170 | | 0.16 | 0.20 | 3.1 | | 0.13 | I |
| I | A-B | 3.45 | | | | | | | | | I |
| I | A-C | 1.19 | | | | | | | | | I |

| I | TIME | DEMAND (VEH/MIN) | CAPACITY (VEH/MIN) | DEMAND/ CAPACITY (RFC) | PEDESTRIAN FLOW (PEDS/MIN) | START QUEUE (VEHS) | END QUEUE (VEHS) | DELAY (VEH.MIN/ TIME SEGMENT) | GEOMETRIC DELAY (VEH.MIN/ TIME SEGMENT) | AVERAGE DELAY PER ARRIVING VEHICLE (MIN) | I |
|---|-------------|---------------------|-----------------------|------------------------------|----------------------------------|--------------------------|------------------------|-------------------------------------|---|--|---|
| I | 08.30-08.45 | | | | | | | | | | I |
| I | B-C | 1.76 | 10.06 | 0.175 | | 0.21 | 0.21 | 3.2 | | 0.12 | I |
| I | B-A | 2.40 | 7.23 | 0.332 | | 0.49 | 0.49 | 7.4 | | 0.21 | I |
| I | C-AB | 1.58 | 9.30 | 0.170 | | 0.20 | 0.21 | 3.1 | | 0.13 | I |
| I | A-B | 3.45 | | | | | | | | | I |
| I | A-C | 1.19 | | | | | | | | | I |

| I | TIME | DEMAND (VEH/MIN) | CAPACITY (VEH/MIN) | DEMAND/ CAPACITY (RFC) | PEDESTRIAN FLOW (PEDS/MIN) | START QUEUE (VEHS) | END QUEUE (VEHS) | DELAY (VEH.MIN/ TIME SEGMENT) | GEOMETRIC DELAY (VEH.MIN/ TIME SEGMENT) | AVERAGE DELAY PER ARRIVING VEHICLE (MIN) | I |
|---|-------------|---------------------|-----------------------|------------------------------|----------------------------------|--------------------------|------------------------|-------------------------------------|---|--|---|
| I | 08.45-09.00 | | | | | | | | | | I |
| I | B-C | 1.44 | 10.37 | 0.139 | | 0.21 | 0.16 | 2.5 | | 0.11 | I |
| I | B-A | 1.96 | 7.46 | 0.263 | | 0.49 | 0.36 | 5.6 | | 0.18 | I |
| I | C-AB | 1.29 | 9.51 | 0.136 | | 0.21 | 0.16 | 2.4 | | 0.12 | I |
| I | A-B | 2.82 | | | | | | | | | I |
| I | A-C | 0.97 | | | | | | | | | I |

| I | TIME | DEMAND (VEH/MIN) | CAPACITY (VEH/MIN) | DEMAND/ CAPACITY (RFC) | PEDESTRIAN FLOW (PEDS/MIN) | START QUEUE (VEHS) | END QUEUE (VEHS) | DELAY (VEH.MIN/ TIME SEGMENT) | GEOMETRIC DELAY (VEH.MIN/ TIME SEGMENT) | AVERAGE DELAY PER ARRIVING VEHICLE (MIN) | I |
|---|-------------|---------------------|-----------------------|------------------------------|----------------------------------|--------------------------|------------------------|-------------------------------------|---|--|---|
| I | 09.00-09.15 | | | | | | | | | | I |
| I | B-C | 1.20 | 10.59 | 0.114 | | 0.16 | 0.13 | 2.0 | | 0.11 | I |
| I | B-A | 1.64 | 7.62 | 0.216 | | 0.36 | 0.28 | 4.3 | | 0.17 | I |
| I | C-AB | 1.08 | 9.66 | 0.112 | | 0.16 | 0.13 | 1.9 | | 0.12 | I |
| I | A-B | 2.36 | | | | | | | | | I |
| I | A-C | 0.82 | | | | | | | | | I |

QUEUE FOR STREAM B-C

| TIME SEGMENT ENDING | NO. OF VEHICLES IN QUEUE |
|------------------------|--------------------------------|
| 08.00 | 0.1 |
| 08.15 | 0.2 |
| 08.30 | 0.2 |
| 08.45 | 0.2 |
| 09.00 | 0.2 |
| 09.15 | 0.1 |

QUEUE FOR STREAM B-A

| TIME SEGMENT ENDING | NO. OF VEHICLES IN QUEUE |
|------------------------|--------------------------------|
| 08.00 | 0.3 |
| 08.15 | 0.4 |
| 08.30 | 0.5 |
| 08.45 | 0.5 |
| 09.00 | 0.4 |
| 09.15 | 0.3 |

QUEUE FOR STREAM C-AB

| TIME SEGMENT ENDING | NO. OF VEHICLES IN QUEUE |
|---------------------|--------------------------|
| 08.00 | 0.1 |
| 08.15 | 0.2 |
| 08.30 | 0.2 |
| 08.45 | 0.2 |
| 09.00 | 0.2 |
| 09.15 | 0.1 |

QUEUEING DELAY INFORMATION OVER WHOLE PERIOD

| I | STREAM | I | TOTAL DEMAND | I | * QUEUEING * * DELAY * | I | * INCLUSIVE QUEUEING * * DELAY * | I | | |
|---|--------|-------|--------------|---|---------------------------|-----------|-------------------------------------|-------|------|---|
| I | I | I | I | I | I | I | I | I | | |
| I | I | (VEH) | (VEH/H) | I | (MIN) | (MIN/VEH) | I | (MIN) | | |
| I | I | I | I | I | I | I | I | I | | |
| I | B-C | I | 132.1 | I | 88.1 | I | 14.9 | I | 0.11 | I |
| I | B-A | I | 180.3 | I | 120.2 | I | 33.3 | I | 0.18 | I |
| I | C-AB | I | 118.4 | I | 78.9 | I | 14.7 | I | 0.12 | I |
| I | A-B | I | 258.8 | I | 172.5 | I | | I | | I |
| I | A-C | I | 89.5 | I | 59.6 | I | | I | | I |
| I | ALL | I | 832.7 | I | 555.2 | I | 63.0 | I | 0.08 | I |

* DELAY IS THAT OCCURRING ONLY WITHIN THE TIME PERIOD .
 * INCLUSIVE DELAY INCLUDES DELAY SUFFERED BY VEHICLES WHICH ARE STILL QUEUEING AFTER THE END OF THE TIME PERIOD.
 * THESE WILL ONLY BE SIGNIFICANTLY DIFFERENT IF THERE IS A LARGE QUEUE REMAINING AT THE END OF THE TIME PERIOD.

END OF JOB

===== end of file =====

TRL LIMITED

(C) COPYRIGHT 2006

CAPACITIES, QUEUES, AND DELAYS AT 3 OR 4-ARM MAJOR/MINOR PRIORITY JUNCTIONS

PICADY 5.0 ANALYSIS PROGRAM
RELEASE 3.0 (JUNE 2006)

ADAPTED FROM PICADY/3 WHICH IS CROWN COPYRIGHT
BY PERMISSION OF THE CONTROLLER OF HMSO

FOR SALES AND DISTRIBUTION INFORMATION,
PROGRAM ADVICE AND MAINTENANCE CONTACT:

TRL SOFTWARE BUREAU
TEL: CROWTHORNE (01344) 770758, FAX: 770864
EMAIL: SoftwareBureau@trl.co.uk

THE USER OF THIS COMPUTER PROGRAM FOR THE SOLUTION OF AN ENGINEERING PROBLEM IS
IN NO WAY RELIEVED OF HIS RESPONSIBILITY FOR THE CORRECTNESS OF THE SOLUTION

Run with file:-

"J:\120000\120669-00\4 Internal Project Data\4-04 Calculations\4-04-06 Junction Analysis\Picady\
Site 12. Somerton Rd - Camp Rd\2013 Base + Gen\PM\
Site 12. Camp Rd - Somerton Rd 2013 Base + Full Development PM.vpi"
(drive-on-the-left) at 10:36:32 on Wednesday, 8 August 2007

RUN INFORMATION

RUN TITLE: Site 12. Camp Road - Somerton Rd 2013 Base + Full Development PM

LOCATION: Oxfordshire

DATE: 31/07/07

CLIENT: North Oxfordshire Consortium

ENUMERATOR: Ian Clarke

JOB NUMBER: 120669

STATUS: TIA

DESCRIPTION:

.MAJOR/MINOR JUNCTION CAPACITY AND DELAY

INPUT DATA

MAJOR ROAD (ARM C) ----- MAJOR ROAD (ARM A)

I
I
I
I
I
I
I

MINOR ROAD (ARM B)

ARM A IS Somerton Rd (N)

ARM B IS Camp Rd

ARM C IS Lower Heyford Rd (S)

STREAM LABELLING CONVENTION

STREAM A-B CONTAINS TRAFFIC GOING FROM ARM A TO ARM B

STREAM B-AC CONTAINS TRAFFIC GOING FROM ARM B TO ARM A AND TO ARM C

ETC.

 GEOMETRIC DATA

| I | DATA ITEM | I | MINOR ROAD B | I |
|---|------------------------------------|------------|--------------|---|
| I | TOTAL MAJOR ROAD CARRIAGEWAY WIDTH | I (W) | 6.00 M. | I |
| I | CENTRAL RESERVE WIDTH | I (WCR) | 0.00 M. | I |
| I | | I | | I |
| I | MAJOR ROAD RIGHT TURN - WIDTH | I (WC-B) | 2.20 M. | I |
| I | - VISIBILITY | I (VC-B) | 89.0 M. | I |
| I | - BLOCKS TRAFFIC | I | YES | I |
| I | | I | | I |
| I | MINOR ROAD - VISIBILITY TO LEFT | I (VB-C) | 30.0 M. | I |
| I | - VISIBILITY TO RIGHT | I (VB-A) | 21.0 M. | I |
| I | - LANE 1 WIDTH | I (WB-C) | - | I |
| I | - LANE 2 WIDTH | I (WB-A) | - | I |
| I | - WIDTH AT 0 M FROM JUNC. | I | 9.00 M. | I |
| I | - WIDTH AT 5 M FROM JUNC. | I | 2.80 M. | I |
| I | - WIDTH AT 10 M FROM JUNC. | I | 2.75 M. | I |
| I | - WIDTH AT 15 M FROM JUNC. | I | 2.75 M. | I |
| I | - WIDTH AT 20 M FROM JUNC. | I | 2.75 M. | I |
| I | - LENGTH OF FLARED SECTION | I DERIVED: | 0 PCU | I |

 .SLOPES AND INTERCEPT

(NB:Streams may be combined, in which case capacity will be adjusted)

| I | Intercept For Stream B-C | Slope For Opposing Stream A-C | Slope For Opposing Stream A-B | I |
|---|--------------------------|-------------------------------|-------------------------------|---|
| I | 586.12 | 0.23 | 0.09 | I |

| I | Intercept For Stream B-A | Slope For Opposing Stream A-C | Slope For Opposing Stream A-B | Slope For Opposing Stream C-A | Slope For Opposing Stream C-B | I |
|---|--------------------------|-------------------------------|-------------------------------|-------------------------------|-------------------------------|---|
| I | 457.77 | 0.21 | 0.08 | 0.13 | 0.30 | I |

| I | Intercept For Stream C-B | Slope For Opposing Stream A-C | Slope For Opposing Stream A-B | I |
|---|--------------------------|-------------------------------|-------------------------------|---|
| I | 625.50 | 0.24 | 0.24 | I |

NB These values do not allow for any site specific corrections

 TRAFFIC DEMAND DATA

| I | TIME | DEMAND (VEH/MIN) | CAPACITY (VEH/MIN) | DEMAND/ CAPACITY (RFC) | PEDESTRIAN FLOW (PEDS/MIN) | START QUEUE (VEHS) | END QUEUE (VEHS) | DELAY (VEH.MIN/ TIME SEGMENT) | GEOMETRIC DELAY (VEH.MIN/ TIME SEGMENT) | AVERAGE DELAY PER ARRIVING VEHICLE (MIN) | I |
|---|-------------|---------------------|-----------------------|------------------------------|----------------------------------|--------------------------|------------------------|-------------------------------------|---|--|---|
| I | 17.15-17.30 | | | | | | | | | | I |
| I | B-C | 1.78 | 9.87 | 0.180 | | 0.16 | 0.22 | 3.2 | | 0.12 | I |
| I | B-A | 3.50 | 7.37 | 0.476 | | 0.59 | 0.88 | 12.5 | | 0.26 | I |
| I | C-AB | 1.43 | 9.61 | 0.149 | | 0.14 | 0.18 | 2.7 | | 0.12 | I |
| I | A-B | 2.79 | | | | | | | | | I |
| I | A-C | 0.59 | | | | | | | | | I |

| I | TIME | DEMAND (VEH/MIN) | CAPACITY (VEH/MIN) | DEMAND/ CAPACITY (RFC) | PEDESTRIAN FLOW (PEDS/MIN) | START QUEUE (VEHS) | END QUEUE (VEHS) | DELAY (VEH.MIN/ TIME SEGMENT) | GEOMETRIC DELAY (VEH.MIN/ TIME SEGMENT) | AVERAGE DELAY PER ARRIVING VEHICLE (MIN) | I |
|---|-------------|---------------------|-----------------------|------------------------------|----------------------------------|--------------------------|------------------------|-------------------------------------|---|--|---|
| I | 17.30-17.45 | | | | | | | | | | I |
| I | B-C | 1.78 | 9.87 | 0.180 | | 0.22 | 0.22 | 3.3 | | 0.12 | I |
| I | B-A | 3.50 | 7.37 | 0.476 | | 0.88 | 0.89 | 13.3 | | 0.26 | I |
| I | C-AB | 1.43 | 9.61 | 0.149 | | 0.18 | 0.18 | 2.7 | | 0.12 | I |
| I | A-B | 2.79 | | | | | | | | | I |
| I | A-C | 0.59 | | | | | | | | | I |

| I | TIME | DEMAND (VEH/MIN) | CAPACITY (VEH/MIN) | DEMAND/ CAPACITY (RFC) | PEDESTRIAN FLOW (PEDS/MIN) | START QUEUE (VEHS) | END QUEUE (VEHS) | DELAY (VEH.MIN/ TIME SEGMENT) | GEOMETRIC DELAY (VEH.MIN/ TIME SEGMENT) | AVERAGE DELAY PER ARRIVING VEHICLE (MIN) | I |
|---|-------------|---------------------|-----------------------|------------------------------|----------------------------------|--------------------------|------------------------|-------------------------------------|---|--|---|
| I | 17.45-18.00 | | | | | | | | | | I |
| I | B-C | 1.45 | 10.22 | 0.142 | | 0.22 | 0.17 | 2.6 | | 0.11 | I |
| I | B-A | 2.86 | 7.57 | 0.378 | | 0.89 | 0.62 | 9.7 | | 0.21 | I |
| I | C-AB | 1.17 | 9.76 | 0.120 | | 0.18 | 0.14 | 2.1 | | 0.12 | I |
| I | A-B | 2.28 | | | | | | | | | I |
| I | A-C | 0.48 | | | | | | | | | I |

| I | TIME | DEMAND (VEH/MIN) | CAPACITY (VEH/MIN) | DEMAND/ CAPACITY (RFC) | PEDESTRIAN FLOW (PEDS/MIN) | START QUEUE (VEHS) | END QUEUE (VEHS) | DELAY (VEH.MIN/ TIME SEGMENT) | GEOMETRIC DELAY (VEH.MIN/ TIME SEGMENT) | AVERAGE DELAY PER ARRIVING VEHICLE (MIN) | I |
|---|-------------|---------------------|-----------------------|------------------------------|----------------------------------|--------------------------|------------------------|-------------------------------------|---|--|---|
| I | 18.00-18.15 | | | | | | | | | | I |
| I | B-C | 1.22 | 10.47 | 0.116 | | 0.17 | 0.13 | 2.0 | | 0.11 | I |
| I | B-A | 2.40 | 7.72 | 0.311 | | 0.62 | 0.46 | 7.1 | | 0.19 | I |
| I | C-AB | 0.98 | 9.87 | 0.099 | | 0.14 | 0.11 | 1.7 | | 0.11 | I |
| I | A-B | 1.91 | | | | | | | | | I |
| I | A-C | 0.40 | | | | | | | | | I |

QUEUE FOR STREAM B-C

| TIME SEGMENT ENDING | NO. OF VEHICLES IN QUEUE |
|------------------------|--------------------------------|
| 17.00 | 0.1 |
| 17.15 | 0.2 |
| 17.30 | 0.2 |
| 17.45 | 0.2 |
| 18.00 | 0.2 |
| 18.15 | 0.1 |

QUEUE FOR STREAM B-A

| TIME SEGMENT ENDING | NO. OF VEHICLES IN QUEUE |
|------------------------|--------------------------------|
| 17.00 | 0.4 |
| 17.15 | 0.6 * |
| 17.30 | 0.9 * |
| 17.45 | 0.9 * |
| 18.00 | 0.6 * |
| 18.15 | 0.5 |

QUEUE FOR STREAM C-AB

| TIME SEGMENT ENDING | NO. OF VEHICLES IN QUEUE |
|---------------------|--------------------------|
| 17.00 | 0.1 |
| 17.15 | 0.1 |
| 17.30 | 0.2 |
| 17.45 | 0.2 |
| 18.00 | 0.1 |
| 18.15 | 0.1 |

QUEUEING DELAY INFORMATION OVER WHOLE PERIOD

| I | STREAM | I | TOTAL DEMAND | I | * QUEUEING * * DELAY * | I | * INCLUSIVE QUEUEING * * DELAY * | I | | | | | | |
|---|--------|-------|--------------|---|---------------------------|-----------|-------------------------------------|-------|------|---|------|---|------|---|
| I | I | I | I | I | I | I | I | I | | | | | | |
| I | I | (VEH) | (VEH/H) | I | (MIN) | (MIN/VEH) | I | (MIN) | | | | | | |
| I | I | I | I | I | I | I | I | I | | | | | | |
| I | B-C | I | 133.5 | I | 89.0 | I | 15.4 | I | 0.12 | I | 15.4 | I | 0.12 | I |
| I | B-A | I | 262.9 | I | 175.3 | I | 57.6 | I | 0.22 | I | 57.6 | I | 0.22 | I |
| I | C-AB | I | 107.4 | I | 71.6 | I | 12.8 | I | 0.12 | I | 12.8 | I | 0.12 | I |
| I | A-B | I | 209.2 | I | 139.5 | I | | I | | I | | I | | I |
| I | A-C | I | 44.0 | I | 29.4 | I | | I | | I | | I | | I |
| I | ALL | I | 869.9 | I | 579.9 | I | 85.8 | I | 0.10 | I | 85.8 | I | 0.10 | I |

* DELAY IS THAT OCCURRING ONLY WITHIN THE TIME PERIOD .
 * INCLUSIVE DELAY INCLUDES DELAY SUFFERED BY VEHICLES WHICH ARE STILL QUEUEING AFTER THE END OF THE TIME PERIOD.
 * THESE WILL ONLY BE SIGNIFICANTLY DIFFERENT IF THERE IS A LARGE QUEUE REMAINING AT THE END OF THE TIME PERIOD.

END OF JOB

===== end of file =====

Appendix E

**M40 Junction 10:
Junction Analyses**

ARCADY 6

ASSESSMENT OF ROUNDABOUT CAPACITY AND DELAY

Analysis Program: Release 3.0 (JUNE 2005)

(c) Copyright TRL Limited, 2004

Adapted from ARCADY/3 which is Crown Copyright by permission of the controller of HMSO

For sales and distribution information, program advice and maintenance, contact:

TRL Limited Tel: +44 (0) 1344 770018
Crowthorne House Fax: +44 (0) 1344 770864
Nine Mile Ride Email: softwarebureau@trl.co.uk
Wokingham, Berks. Web: www.trlsoftware.co.uk
RG40 3GA,UK

THE USER OF THIS COMPUTER PROGRAM FOR THE SOLUTION OF AN ENGINEERING PROBLEM IS IN NO WAY RELIEVED OF THEIR RESPONSIBILITY FOR THE CORRECTNESS OF THE SOLUTION

Run with file:-

"j:\120000\120669-00\4 Internal Project Data\4-04 Calculations\4-04-06 Junction Analysis\Arcady\2013 Base\AM\B430 Roundabout - 2013 Base AM.vai"
(drive-on-the-left) at 16:27:25 on Monday, 12 February 2007

FILE PROPERTIES *****

RUN TITLE: B430 Roundabout - Junction 10 - 2013 Base AM
LOCATION: Oxfordshire
DATE: 18/01/2007
CLIENT: North Oxfordshire Consortium
ENUMERATOR: chris.morris [MCCPC062011]
JOB NUMBER: 120669
STATUS:
DESCRIPTION:

INPUT DATA *****
ARM A - A43
ARM B - M40 Slips
ARM C - B430

GEOMETRIC DATA

Table with 15 columns: I ARM, I, V (M), I, E (M), I, L (M), I, R (M), I, D (M), I, PHI (DEG), I, SLOPE, I, INTERCEPT (PCU/MIN), I. Rows include data for ARM A, B, and C.

V = approach half-width L = effective flare length D = inscribed circle diameter
E = entry width R = entry radius PHI = entry angle

WARNING ARM C: Effective flare length is outside normal range.
Treat capacities with increasing caution.

WARNING ARM A - INPUT VALUE OF V (7.30) OUTSIDE ACCEPTABLE RANGE -
HAS BEEN RESET AS INDICATED ABOVE (*). (AG17 REF. 6.3.1).

TRAFFIC DEMAND DATA

(Only sets included in the current run are shown)

| ARM | FLOW SCALE (%) |
|-----|----------------|
| A | 100 |
| B | 100 |
| C | 100 |

TIME PERIOD BEGINS 07.45 AND ENDS 09.15

LENGTH OF TIME PERIOD - 90 MINUTES.
 LENGTH OF TIME SEGMENT - 15 MINUTES.

DEMAND FLOW PROFILES ARE SYNTHESISED FROM TURNING COUNT DATA

DEMAND SET TITLE: B430 Roundabout - Junction 10 - 2013 Base AM

| ARM | NUMBER OF MINUTES FROM START WHEN FLOW STARTS TO RISE | TOP OF PEAK IS REACHED | FLOW STOPS IF FALLING | RATE OF FLOW (VEH/MIN) BEFORE PEAK | AT TOP OF PEAK | AFTER PEAK |
|-------|---|------------------------|-----------------------|------------------------------------|----------------|------------|
| ARM A | 15.00 | 45.00 | 75.00 | 13.21 | 19.82 | 13.21 |
| ARM B | 15.00 | 45.00 | 75.00 | 14.88 | 22.31 | 14.88 |
| ARM C | 15.00 | 45.00 | 75.00 | 5.00 | 7.50 | 5.00 |

DEMAND SET TITLE: B430 Roundabout - Junction 10 - 2013 Base AM

| TIME | TURNING PROPORTIONS | | | TURNING COUNTS (VEH/HR) | | | (PERCENTAGE OF H.V.S) | | | |
|---------------|---------------------|-------|-------|-------------------------|--------|-------|-----------------------|--------|--------|--------|
| | FROM/TO | ARM A | ARM B | ARM C | ARM A | ARM B | ARM C | ARM A | ARM B | ARM C |
| 07.45 - 09.15 | ARM A | 0.000 | 0.373 | 0.627 | 0.0 | 394.0 | 663.0 | (0.0) | (0.0) | (0.0) |
| | ARM B | 0.980 | 0.000 | 0.020 | 1166.0 | 0.0 | 24.0 | (0.0) | (0.0) | (0.0) |
| | ARM C | 0.488 | 0.512 | 0.000 | 195.0 | 205.0 | 0.0 | (0.0) | (0.0) | (0.0) |

QUEUE AND DELAY INFORMATION FOR EACH 15 MIN TIME SEGMENT

| TIME | DEMAND (VEH/MIN) | CAPACITY (VEH/MIN) | DEMAND/CAPACITY (RFC) | PEDESTRIAN FLOW (PEDS/MIN) | START QUEUE (VEHS) | END QUEUE (VEHS) | DELAY (VEH.MIN/TIME SEGMENT) | GEOMETRIC DELAY (VEH.MIN/TIME SEGMENT) | AVERAGE DELAY PER ARRIVING VEHICLE (MIN) |
|--|------------------|--------------------|-----------------------|----------------------------|-----------------------|------------------|------------------------------|--|--|
| 07.45-08.00 | | | | | | | | | |
| ARM A | 13.21 | 37.24 | 0.355 | | 0.0 | 0.5 | 8.1 | | 0.04 |
| ARM B | 14.88 | 30.88 | 0.482 | | 0.0 | 0.9 | 13.4 | | 0.06 |
| ARM C | 5.00 | 27.49 | 0.182 | | 0.0 | 0.2 | 3.3 | | 0.04 |
| EFFECT ON CAPACITY (PCU/MIN) OF MARGINAL CHANGES IN: | | | | | | | | | |
| | MARGINAL CHANGE: | ENTRY WIDTH (.1M) | FLARE LENGTH (M) | INSCRIBED CIRC DIAM (M) | ENTRY ANGLE (10 DEGS) | | | | |
| | ARM A | 0.522 | 0.000 | 0.012 | -1.218 | | | | |
| | ARM B | 0.507 | 0.000 | 0.039 | -0.983 | | | | |
| | ARM C | 0.198 | 0.133 | 0.065 | -0.981 | | | | |

| TIME | DEMAND (VEH/MIN) | CAPACITY (VEH/MIN) | DEMAND/ CAPACITY (RFC) | PEDESTRIAN FLOW (PEDS/MIN) | START QUEUE (VEHS) | END QUEUE (VEHS) | DELAY (VEH.MIN/ TIME SEGMENT) | GEOMETRIC DELAY (VEH.MIN/ TIME SEGMENT) | AVERAGE DELAY PER ARRIVING VEHICLE (MIN) |
|--|---------------------|-----------------------|------------------------------|----------------------------------|--------------------------|------------------------|-------------------------------------|---|--|
| 08.00-08.15 | | | | | | | | | |
| ARM A | 15.78 | 36.94 | 0.427 | | 0.5 | 0.7 | 10.9 | | 0.05 |
| ARM B | 17.76 | 29.93 | 0.594 | | 0.9 | 1.4 | 20.9 | | 0.08 |
| ARM C | 5.97 | 25.90 | 0.231 | | 0.2 | 0.3 | 4.4 | | 0.05 |
| EFFECT ON CAPACITY (PCU/MIN) OF MARGINAL CHANGES IN: | | | | | | | | | |
| MARGINAL ENTRY FLARE INSCRIBED ENTRY | | | | | | | | | |
| CHANGE: WIDTH LENGTH CIRC DIAM ANGLE | | | | | | | | | |
| (0.1M) (M) (M) (10 DEGS) | | | | | | | | | |
| ARM A | | 0.520 | | 0.000 | 0.015 | | -1.208 | | |
| ARM B | | 0.499 | | 0.000 | 0.046 | | -0.953 | | |
| ARM C | | 0.192 | | 0.129 | 0.077 | | -0.924 | | |

| TIME | DEMAND (VEH/MIN) | CAPACITY (VEH/MIN) | DEMAND/ CAPACITY (RFC) | PEDESTRIAN FLOW (PEDS/MIN) | START QUEUE (VEHS) | END QUEUE (VEHS) | DELAY (VEH.MIN/ TIME SEGMENT) | GEOMETRIC DELAY (VEH.MIN/ TIME SEGMENT) | AVERAGE DELAY PER ARRIVING VEHICLE (MIN) |
|--|---------------------|-----------------------|------------------------------|----------------------------------|--------------------------|------------------------|-------------------------------------|---|--|
| 08.15-08.30 | | | | | | | | | |
| ARM A | 19.32 | 36.52 | 0.529 | | 0.7 | 1.1 | 16.3 | | 0.06 |
| ARM B | 21.75 | 28.63 | 0.760 | | 1.4 | 3.0 | 42.5 | | 0.14 |
| ARM C | 7.31 | 23.76 | 0.308 | | 0.3 | 0.4 | 6.5 | | 0.06 |
| EFFECT ON CAPACITY (PCU/MIN) OF MARGINAL CHANGES IN: | | | | | | | | | |
| MARGINAL ENTRY FLARE INSCRIBED ENTRY | | | | | | | | | |
| CHANGE: WIDTH LENGTH CIRC DIAM ANGLE | | | | | | | | | |
| (0.1M) (M) (M) (10 DEGS) | | | | | | | | | |
| ARM A | | 0.517 | | 0.000 | 0.018 | | -1.194 | | |
| ARM B | | 0.488 | | 0.000 | 0.057 | | -0.911 | | |
| ARM C | | 0.184 | | 0.123 | 0.094 | | -0.847 | | |

| TIME | DEMAND (VEH/MIN) | CAPACITY (VEH/MIN) | DEMAND/ CAPACITY (RFC) | PEDESTRIAN FLOW (PEDS/MIN) | START QUEUE (VEHS) | END QUEUE (VEHS) | DELAY (VEH.MIN/ TIME SEGMENT) | GEOMETRIC DELAY (VEH.MIN/ TIME SEGMENT) | AVERAGE DELAY PER ARRIVING VEHICLE (MIN) |
|--|---------------------|-----------------------|------------------------------|----------------------------------|--------------------------|------------------------|-------------------------------------|---|--|
| 08.30-08.45 | | | | | | | | | |
| ARM A | 19.32 | 36.52 | 0.529 | | 1.1 | 1.1 | 16.8 | | 0.06 |
| ARM B | 21.75 | 28.62 | 0.760 | | 3.0 | 3.1 | 46.3 | | 0.15 |
| ARM C | 7.31 | 23.70 | 0.309 | | 0.4 | 0.4 | 6.7 | | 0.06 |
| EFFECT ON CAPACITY (PCU/MIN) OF MARGINAL CHANGES IN: | | | | | | | | | |
| MARGINAL ENTRY FLARE INSCRIBED ENTRY | | | | | | | | | |
| CHANGE: WIDTH LENGTH CIRC DIAM ANGLE | | | | | | | | | |
| (0.1M) (M) (M) (10 DEGS) | | | | | | | | | |
| ARM A | | 0.517 | | 0.000 | 0.018 | | -1.194 | | |
| ARM B | | 0.488 | | 0.000 | 0.057 | | -0.911 | | |
| ARM C | | 0.184 | | 0.123 | 0.095 | | -0.845 | | |

| TIME | DEMAND (VEH/MIN) | CAPACITY (VEH/MIN) | DEMAND/ CAPACITY (RFC) | PEDESTRIAN FLOW (PEDS/MIN) | START QUEUE (VEHS) | END QUEUE (VEHS) | DELAY (VEH.MIN/ TIME SEGMENT) | GEOMETRIC DELAY (VEH.MIN/ TIME SEGMENT) | AVERAGE DELAY PER ARRIVING VEHICLE (MIN) |
|--|---------------------|-----------------------|------------------------------|----------------------------------|--------------------------|------------------------|-------------------------------------|---|--|
| 08.45-09.00 | | | | | | | | | |
| ARM A | 15.78 | 36.93 | 0.427 | | 1.1 | 0.7 | 11.5 | | 0.05 |
| ARM B | 17.76 | 29.91 | 0.594 | | 3.1 | 1.5 | 23.2 | | 0.08 |
| ARM C | 5.97 | 25.82 | 0.231 | | 0.4 | 0.3 | 4.6 | | 0.05 |
| EFFECT ON CAPACITY (PCU/MIN) OF MARGINAL CHANGES IN: | | | | | | | | | |
| MARGINAL ENTRY FLARE INSCRIBED ENTRY | | | | | | | | | |
| CHANGE: WIDTH LENGTH CIRC DIAM ANGLE | | | | | | | | | |
| (0.1M) (M) (M) (10 DEGS) | | | | | | | | | |
| ARM A | | 0.520 | | 0.000 | 0.015 | | -1.208 | | |
| ARM B | | 0.499 | | 0.000 | 0.046 | | -0.952 | | |
| ARM C | | 0.192 | | 0.129 | 0.078 | | -0.921 | | |

| TIME | DEMAND (VEH/MIN) | CAPACITY (VEH/MIN) | DEMAND/ CAPACITY (RFC) | PEDESTRIAN FLOW (PEDS/MIN) | START QUEUE (VEHS) | END QUEUE (VEHS) | DELAY (VEH.MIN/ TIME SEGMENT) | GEOMETRIC DELAY (VEH.MIN/ TIME SEGMENT) | AVERAGE DELAY PER ARRIVING VEHICLE (MIN) |
|-------------|---------------------|-----------------------|------------------------------|----------------------------------|--------------------------|------------------------|-------------------------------------|---|--|
| 09.00-09.15 | | | | | | | | | |
| ARM A | 13.21 | 37.24 | 0.355 | | 0.7 | 0.6 | 8.4 | | 0.04 |
| ARM B | 14.88 | 30.86 | 0.482 | | 1.5 | 0.9 | 14.4 | | 0.06 |
| ARM C | 5.00 | 27.44 | 0.182 | | 0.3 | 0.2 | 3.4 | | 0.04 |

| EFFECT ON CAPACITY (PCU/MIN) OF MARGINAL CHANGES IN: | | | | | |
|--|---------------------|-------------------------|------------------------|-------------------------------|-----------------------------|
| | MARGINAL CHANGE: | ENTRY WIDTH (.1M) | FLARE LENGTH (M) | INSCRIBED CIRC DIAM (M) | ENTRY ANGLE (10 DEGS) |
| ARM A | | 0.522 | 0.000 | 0.012 | -1.218 |
| ARM B | | 0.507 | 0.000 | 0.039 | -0.982 |
| ARM C | | 0.198 | 0.133 | 0.065 | -0.979 |

QUEUE AT ARM A

| TIME SEGMENT ENDING | NO. OF VEHICLES IN QUEUE |
|------------------------|--------------------------------|
| 08.00 | 0.5 * |
| 08.15 | 0.7 * |
| 08.30 | 1.1 * |
| 08.45 | 1.1 * |
| 09.00 | 0.7 * |
| 09.15 | 0.6 * |

QUEUE AT ARM B

| TIME SEGMENT ENDING | NO. OF VEHICLES IN QUEUE |
|------------------------|--------------------------------|
| 08.00 | 0.9 * |
| 08.15 | 1.4 * |
| 08.30 | 3.0 *** |
| 08.45 | 3.1 *** |
| 09.00 | 1.5 * |
| 09.15 | 0.9 * |

QUEUE AT ARM C

| TIME SEGMENT ENDING | NO. OF VEHICLES IN QUEUE |
|------------------------|--------------------------------|
| 08.00 | 0.2 |
| 08.15 | 0.3 |
| 08.30 | 0.4 |
| 08.45 | 0.4 |
| 09.00 | 0.3 |
| 09.15 | 0.2 |

 QUEUEING DELAY INFORMATION OVER WHOLE PERIOD

| I | ARM | I | TOTAL DEMAND | | * QUEUEING * | | * INCLUSIVE QUEUEING * | |
|---|-----|---|--------------|----------|--------------|-----------|------------------------|-----------|
| | | | I | I | I | I | I | I |
| | | | (VEH) | (VEH/H) | (MIN) | (MIN/VEH) | (MIN) | (MIN/VEH) |
| I | A | I | 1449.4 | I 966.2 | I 72.0 | I 0.05 | I 72.0 | I 0.05 |
| I | B | I | 1631.7 | I 1087.8 | I 160.8 | I 0.10 | I 160.8 | I 0.10 |
| I | C | I | 548.5 | I 365.7 | I 28.9 | I 0.05 | I 28.9 | I 0.05 |
| I | ALL | I | 3629.6 | I 2419.7 | I 261.6 | I 0.07 | I 261.6 | I 0.07 |

* DELAY IS THAT OCCURRING ONLY WITHIN THE TIME PERIOD.
 * INCLUSIVE DELAY INCLUDES DELAY SUFFERED BY VEHICLES WHICH ARE STILL QUEUEING AFTER THE END OF THE TIME PERIOD.
 * THESE WILL ONLY BE SIGNIFICANTLY DIFFERENT IF THERE IS A LARGE QUEUE REMAINING AT THE END OF THE TIME PERIOD.

END OF JOB

===== end of file =====

ARCADY 6

ASSESSMENT OF ROUNDABOUT CAPACITY AND DELAY

Analysis Program: Release 3.0 (JUNE 2005)

(c) Copyright TRL Limited, 2004

Adapted from ARCADY/3 which is Crown Copyright
by permission of the controller of HMSO

For sales and distribution information,
program advice and maintenance, contact:

TRL Limited Tel: +44 (0) 1344 770018
Crowthorne House Fax: +44 (0) 1344 770864
Nine Mile Ride Email: softwarebureau@trl.co.uk
Wokingham, Berks. Web: www.trlsoftware.co.uk
RG40 3GA, UK

THE USER OF THIS COMPUTER PROGRAM FOR THE SOLUTION OF AN ENGINEERING PROBLEM IS
IN NO WAY RELIEVED OF THEIR RESPONSIBILITY FOR THE CORRECTNESS OF THE SOLUTION

Run with file:-

"j:\120000\120669-00\4 Internal Project Data\4-04 Calculations\4-04-06 Junction Analysis\Arcady\2013 Base\PM\
B430 Roundabout - 2013 Base PM.vai"
(drive-on-the-left) at 16:29:55 on Monday, 12 February 2007

FILE PROPERTIES

RUN TITLE: B430 Roundabout - Junction 10 - 2013 Base PM
LOCATION: Oxfordshire
DATE: 18/01/2007
CLIENT: North Oxfordshire Consortium
ENUMERATOR: chris.morris [MCCPC062011]
JOB NUMBER: 120669
STATUS:
DESCRIPTION:

INPUT DATA

ARM A - A43
ARM B - M40 Slips
ARM C - B430

GEOMETRIC DATA

| I | ARM | I | V (M) | I | E (M) | I | L (M) | I | R (M) | I | D (M) | I | PHI (DEG) | I | SLOPE | I | INTERCEPT (PCU/MIN) | I |
|---|-------|---|--------|---|-------|---|-------|---|-------|---|-------|---|-----------|---|-------|---|---------------------|---|
| I | ARM A | I | 7.25 * | I | 7.25 | I | 0.00 | I | 30.00 | I | 72.00 | I | 17.5 | I | 0.608 | I | 38.797 | I |
| I | ARM B | I | 6.00 | I | 6.50 | I | 0.00 | I | 50.00 | I | 72.00 | I | 13.0 | I | 0.587 | I | 35.724 | I |
| I | ARM C | I | 3.50 | I | 9.00 | I | 38.00 | I | 22.50 | I | 72.00 | I | 40.0 | I | 0.558 | I | 35.585 | I |

V = approach half-width L = effective flare length D = inscribed circle diameter
E = entry width R = entry radius PHI = entry angle

WARNING ARM C: Effective flare length is outside normal range.
Treat capacities with increasing caution.

WARNING ARM A - INPUT VALUE OF V (7.30) OUTSIDE ACCEPTABLE RANGE -
HAS BEEN RESET AS INDICATED ABOVE (*). (AG17 REF. 6.3.1).

TRAFFIC DEMAND DATA

(Only sets included in the current run are shown)

| ARM | FLOW SCALE (%) |
|-----|----------------|
| A | 100 |
| B | 100 |
| C | 100 |

TIME PERIOD BEGINS 16.45 AND ENDS 18.15

LENGTH OF TIME PERIOD - 90 MINUTES.
 LENGTH OF TIME SEGMENT - 15 MINUTES.

DEMAND FLOW PROFILES ARE SYNTHESISED FROM TURNING COUNT DATA

DEMAND SET TITLE: B430 Roundabout - Junction 10 - 2013 Base PM

| ARM | NUMBER OF MINUTES FROM START WHEN FLOW STARTS TO RISE | TOP OF PEAK IS REACHED | FLOW STOPS FALLING | RATE OF FLOW (VEH/MIN) BEFORE PEAK | AT TOP OF PEAK | AFTER PEAK |
|-------|---|------------------------|--------------------|------------------------------------|----------------|------------|
| ARM A | 15.00 | 45.00 | 75.00 | 7.76 | 11.64 | 7.76 |
| ARM B | 15.00 | 45.00 | 75.00 | 18.77 | 28.16 | 18.77 |
| ARM C | 15.00 | 45.00 | 75.00 | 4.60 | 6.90 | 4.60 |

DEMAND SET TITLE: B430 Roundabout - Junction 10 - 2013 Base PM

| TIME | TURNING PROPORTIONS | | | TURNING COUNTS (VEH/HR) | | | |
|---------------|---------------------|--------|--------|-------------------------|--------|-------|-------|
| | FROM/TO | ARM A | ARM B | ARM C | ARM A | ARM B | ARM C |
| 16.45 - 18.15 | ARM A | 0.002 | 0.459 | 0.539 | 1.0 | 285.0 | 335.0 |
| | | (0.0) | (0.0) | (0.0) | | | |
| | ARM B | 0.966 | 0.000 | 0.034 | 1451.0 | 0.0 | 51.0 |
| | | (0.0) | (0.0) | (0.0) | | | |
| | ARM C | 0.701 | 0.299 | 0.000 | 258.0 | 110.0 | 0.0 |
| | | (0.0) | (0.0) | (0.0) | | | |

QUEUE AND DELAY INFORMATION FOR EACH 15 MIN TIME SEGMENT

| TIME | DEMAND (VEH/MIN) | CAPACITY (VEH/MIN) | DEMAND/CAPACITY (RFC) | PEDESTRIAN FLOW (PEDS/MIN) | START QUEUE (VEHS) | END QUEUE (VEHS) | DELAY (VEH.MIN/TIME SEGMENT) | GEOMETRIC DELAY (VEH.MIN/TIME SEGMENT) | AVERAGE DELAY PER ARRIVING VEHICLE (MIN) |
|--|------------------|--------------------|-----------------------|----------------------------|-----------------------|------------------|------------------------------|--|--|
| 16.45-17.00 | | | | | | | | | |
| ARM A | 7.76 | 37.96 | 0.204 | | 0.0 | 0.3 | 3.8 | | 0.03 |
| ARM B | 18.77 | 33.27 | 0.564 | | 0.0 | 1.3 | 18.6 | | 0.07 |
| ARM C | 4.60 | 25.51 | 0.180 | | 0.0 | 0.2 | 3.2 | | 0.05 |
| EFFECT ON CAPACITY (PCU/MIN) OF MARGINAL CHANGES IN: | | | | | | | | | |
| | MARGINAL CHANGE: | ENTRY WIDTH (.1M) | FLARE LENGTH (M) | INSCRIBED CIRC DIAM (M) | ENTRY ANGLE (10 DEGS) | | | | |
| | ARM A | 0.528 | 0.000 | 0.007 | -1.241 | | | | |
| | ARM B | 0.528 | 0.000 | 0.020 | -1.059 | | | | |
| | ARM C | 0.191 | 0.128 | 0.080 | -0.910 | | | | |

| TIME | DEMAND (VEH/MIN) | CAPACITY (VEH/MIN) | DEMAND/ CAPACITY (RFC) | PEDESTRIAN FLOW (PEDS/MIN) | START QUEUE (VEHS) | END QUEUE (VEHS) | DELAY (VEH.MIN/ TIME SEGMENT) | GEOMETRIC DELAY (VEH.MIN/ TIME SEGMENT) | AVERAGE DELAY PER ARRIVING VEHICLE (MIN) |
|--|---------------------|-----------------------|------------------------------|----------------------------------|--------------------------|------------------------|-------------------------------------|---|--|
| 17.00-17.15 | | | | | | | | | |
| ARM A | 9.27 | 37.80 | 0.245 | | 0.3 | 0.3 | 4.8 | | 0.04 |
| ARM B | 22.42 | 32.78 | 0.684 | | 1.3 | 2.1 | 30.5 | | 0.10 |
| ARM C | 5.49 | 23.53 | 0.233 | | 0.2 | 0.3 | 4.5 | | 0.06 |
| EFFECT ON CAPACITY (PCU/MIN) OF MARGINAL CHANGES IN: | | | | | | | | | |
| | MARGINAL | ENTRY | FLARE | INSCRIBED | ENTRY | | | | |
| | CHANGE: | WIDTH | LENGTH | CIRC DIAM | ANGLE | | | | |
| | | (.1M) | (M) | (M) | (10 DEGS) | | | | |
| | ARM A | 0.527 | 0.000 | 0.008 | -1.236 | | | | |
| | ARM B | 0.524 | 0.000 | 0.023 | -1.044 | | | | |
| | ARM C | 0.183 | 0.123 | 0.096 | -0.839 | | | | |

| TIME | DEMAND (VEH/MIN) | CAPACITY (VEH/MIN) | DEMAND/ CAPACITY (RFC) | PEDESTRIAN FLOW (PEDS/MIN) | START QUEUE (VEHS) | END QUEUE (VEHS) | DELAY (VEH.MIN/ TIME SEGMENT) | GEOMETRIC DELAY (VEH.MIN/ TIME SEGMENT) | AVERAGE DELAY PER ARRIVING VEHICLE (MIN) |
|--|---------------------|-----------------------|------------------------------|----------------------------------|--------------------------|------------------------|-------------------------------------|---|--|
| 17.15-17.30 | | | | | | | | | |
| ARM A | 11.35 | 37.58 | 0.302 | | 0.3 | 0.4 | 6.4 | | 0.04 |
| ARM B | 27.46 | 32.12 | 0.855 | | 2.1 | 5.4 | 71.9 | | 0.20 |
| ARM C | 6.73 | 20.90 | 0.322 | | 0.3 | 0.5 | 6.9 | | 0.07 |
| EFFECT ON CAPACITY (PCU/MIN) OF MARGINAL CHANGES IN: | | | | | | | | | |
| | MARGINAL | ENTRY | FLARE | INSCRIBED | ENTRY | | | | |
| | CHANGE: | WIDTH | LENGTH | CIRC DIAM | ANGLE | | | | |
| | | (.1M) | (M) | (M) | (10 DEGS) | | | | |
| | ARM A | 0.525 | 0.000 | 0.010 | -1.229 | | | | |
| | ARM B | 0.518 | 0.000 | 0.029 | -1.023 | | | | |
| | ARM C | 0.173 | 0.116 | 0.117 | -0.745 | | | | |

| TIME | DEMAND (VEH/MIN) | CAPACITY (VEH/MIN) | DEMAND/ CAPACITY (RFC) | PEDESTRIAN FLOW (PEDS/MIN) | START QUEUE (VEHS) | END QUEUE (VEHS) | DELAY (VEH.MIN/ TIME SEGMENT) | GEOMETRIC DELAY (VEH.MIN/ TIME SEGMENT) | AVERAGE DELAY PER ARRIVING VEHICLE (MIN) |
|--|---------------------|-----------------------|------------------------------|----------------------------------|--------------------------|------------------------|-------------------------------------|---|--|
| 17.30-17.45 | | | | | | | | | |
| ARM A | 11.35 | 37.57 | 0.302 | | 0.4 | 0.4 | 6.5 | | 0.04 |
| ARM B | 27.46 | 32.12 | 0.855 | | 5.4 | 5.6 | 83.0 | | 0.21 |
| ARM C | 6.73 | 20.79 | 0.324 | | 0.5 | 0.5 | 7.1 | | 0.07 |
| EFFECT ON CAPACITY (PCU/MIN) OF MARGINAL CHANGES IN: | | | | | | | | | |
| | MARGINAL | ENTRY | FLARE | INSCRIBED | ENTRY | | | | |
| | CHANGE: | WIDTH | LENGTH | CIRC DIAM | ANGLE | | | | |
| | | (.1M) | (M) | (M) | (10 DEGS) | | | | |
| | ARM A | 0.525 | 0.000 | 0.010 | -1.229 | | | | |
| | ARM B | 0.518 | 0.000 | 0.029 | -1.023 | | | | |
| | ARM C | 0.173 | 0.116 | 0.118 | -0.741 | | | | |

| TIME | DEMAND (VEH/MIN) | CAPACITY (VEH/MIN) | DEMAND/ CAPACITY (RFC) | PEDESTRIAN FLOW (PEDS/MIN) | START QUEUE (VEHS) | END QUEUE (VEHS) | DELAY (VEH.MIN/ TIME SEGMENT) | GEOMETRIC DELAY (VEH.MIN/ TIME SEGMENT) | AVERAGE DELAY PER ARRIVING VEHICLE (MIN) |
|--|---------------------|-----------------------|------------------------------|----------------------------------|--------------------------|------------------------|-------------------------------------|---|--|
| 17.45-18.00 | | | | | | | | | |
| ARM A | 9.27 | 37.80 | 0.245 | | 0.4 | 0.3 | 4.9 | | 0.04 |
| ARM B | 22.42 | 32.78 | 0.684 | | 5.6 | 2.2 | 35.5 | | 0.10 |
| ARM C | 5.49 | 23.38 | 0.235 | | 0.5 | 0.3 | 4.7 | | 0.06 |
| EFFECT ON CAPACITY (PCU/MIN) OF MARGINAL CHANGES IN: | | | | | | | | | |
| | MARGINAL | ENTRY | FLARE | INSCRIBED | ENTRY | | | | |
| | CHANGE: | WIDTH | LENGTH | CIRC DIAM | ANGLE | | | | |
| | | (.1M) | (M) | (M) | (10 DEGS) | | | | |
| | ARM A | 0.527 | 0.000 | 0.008 | -1.236 | | | | |
| | ARM B | 0.524 | 0.000 | 0.023 | -1.044 | | | | |
| | ARM C | 0.182 | 0.122 | 0.097 | -0.834 | | | | |

| I | TIME | DEMAND (VEH/MIN) | CAPACITY (VEH/MIN) | DEMAND/ CAPACITY (RFC) | PEDESTRIAN FLOW (PEDS/MIN) | START QUEUE (VEHS) | END QUEUE (VEHS) | DELAY (VEH.MIN/ TIME SEGMENT) | GEOMETRIC DELAY (VEH.MIN/ TIME SEGMENT) | AVERAGE DELAY PER ARRIVING VEHICLE (MIN) | I |
|---|-------------|---------------------|--|------------------------------|----------------------------------|--------------------------|------------------------|-------------------------------------|---|--|---|
| I | 18.00-18.15 | | | | | | | | | | I |
| I | ARM A | 7.76 | 37.96 | 0.204 | | 0.3 | 0.3 | 3.9 | | 0.03 | I |
| I | ARM B | 18.77 | 33.26 | 0.564 | | 2.2 | 1.3 | 20.3 | | 0.07 | I |
| I | ARM C | 4.60 | 25.43 | 0.181 | | 0.3 | 0.2 | 3.4 | | 0.05 | I |
| I | | | | | | | | | | | I |
| I | | | EFFECT ON CAPACITY (PCU/MIN) OF MARGINAL CHANGES IN: | | | | | | | | I |
| I | | | ENTRY | FLARE | INSCRIBED | ENTRY | | | | | I |
| I | | MARGINAL | WIDTH | LENGTH | CIRC DIAM | ANGLE | | | | | I |
| I | | CHANGE: | (.1M) | (M) | (M) | (10 DEGS) | | | | | I |
| I | | ARM A | 0.528 | 0.000 | 0.007 | -1.241 | | | | | I |
| I | | ARM B | 0.528 | 0.000 | 0.020 | -1.059 | | | | | I |
| I | | ARM C | 0.190 | 0.128 | 0.081 | -0.907 | | | | | I |
| I | | | | | | | | | | | I |

QUEUE AT ARM A

| TIME SEGMENT ENDING | NO. OF VEHICLES IN QUEUE |
|------------------------|--------------------------------|
| 17.00 | 0.3 |
| 17.15 | 0.3 |
| 17.30 | 0.4 |
| 17.45 | 0.4 |
| 18.00 | 0.3 |
| 18.15 | 0.3 |

QUEUE AT ARM B

| TIME SEGMENT ENDING | NO. OF VEHICLES IN QUEUE |
|------------------------|--------------------------------|
| 17.00 | 1.3 * |
| 17.15 | 2.1 ** |
| 17.30 | 5.4 ***** |
| 17.45 | 5.6 ***** |
| 18.00 | 2.2 ** |
| 18.15 | 1.3 * |

QUEUE AT ARM C

| TIME SEGMENT ENDING | NO. OF VEHICLES IN QUEUE |
|------------------------|--------------------------------|
| 17.00 | 0.2 |
| 17.15 | 0.3 |
| 17.30 | 0.5 |
| 17.45 | 0.5 |
| 18.00 | 0.3 |
| 18.15 | 0.2 |

 QUEUEING DELAY INFORMATION OVER WHOLE PERIOD

| I | ARM | I | TOTAL DEMAND | | I | * QUEUEING * | | I | * INCLUSIVE QUEUEING * | | I |
|---|-----|---|--------------|----------|---|--------------|-----------|---|------------------------|-----------|---|
| I | | I | | I | I | * DELAY * | | I | * DELAY * | | I |
| I | | I | (VEH) | (VEH/H) | I | (MIN) | (MIN/VEH) | I | (MIN) | (MIN/VEH) | I |
| I | A | I | 851.5 | I 567.7 | I | 30.3 | I 0.04 | I | 30.3 | I 0.04 | I |
| I | B | I | 2059.6 | I 1373.0 | I | 259.7 | I 0.13 | I | 259.8 | I 0.13 | I |
| I | C | I | 504.6 | I 336.4 | I | 29.8 | I 0.06 | I | 29.8 | I 0.06 | I |
| I | ALL | I | 3415.7 | I 2277.1 | I | 319.9 | I 0.09 | I | 319.9 | I 0.09 | I |

* DELAY IS THAT OCCURRING ONLY WITHIN THE TIME PERIOD.
 * INCLUSIVE DELAY INCLUDES DELAY SUFFERED BY VEHICLES WHICH ARE STILL QUEUEING AFTER THE END OF THE TIME PERIOD.
 * THESE WILL ONLY BE SIGNIFICANTLY DIFFERENT IF THERE IS A LARGE QUEUE REMAINING AT THE END OF THE TIME PERIOD.

END OF JOB

===== end of file =====

ARCADY 6

ASSESSMENT OF ROUNDABOUT CAPACITY AND DELAY

Analysis Program: Release 3.0 (JUNE 2005)

(c) Copyright TRL Limited, 2004

Adapted from ARCADY/3 which is Crown Copyright
by permission of the controller of HMSO

For sales and distribution information,
program advice and maintenance, contact:

TRL Limited Tel: +44 (0) 1344 770018
Crowthorne House Fax: +44 (0) 1344 770864
Nine Mile Ride Email: softwarebureau@trl.co.uk
Wokingham, Berks. Web: www.trlsoftware.co.uk
RG40 3GA,UK

THE USER OF THIS COMPUTER PROGRAM FOR THE SOLUTION OF AN ENGINEERING PROBLEM IS
IN NO WAY RELIEVED OF THEIR RESPONSIBILITY FOR THE CORRECTNESS OF THE SOLUTION

Run with file:-

"j:\120000\120669-00\4 Internal Project Data\4-04 Calculations\4-04-06 Junction Analysis\Arcady\2013 Base + Gen\
AM\B430 Roundabout - 2013 Base + Gen AM.vai"
(drive-on-the-left) at 16:38:12 on Thursday, 2 August 2007

FILE PROPERTIES

RUN TITLE: B430 Roundabout - Junction 10 - 2013 Base + Gen AM
LOCATION: Oxfordshire
DATE: 31/07/2007
CLIENT: North Oxfordshire Consortium
ENUMERATOR: Paul Dickens
JOB NUMBER: 120669
STATUS:
DESCRIPTION:

INPUT DATA

ARM A - A43
ARM B - M40 Slips
ARM C - B430

GEOMETRIC DATA

| I | ARM | I | V (M) | I | E (M) | I | L (M) | I | R (M) | I | D (M) | I | PHI (DEG) | I | SLOPE | I | INTERCEPT (PCU/MIN) | I |
|---|-------|---|--------|---|-------|---|-------|---|-------|---|-------|---|-----------|---|-------|---|---------------------|---|
| I | ARM A | I | 7.25 * | I | 7.25 | I | 0.00 | I | 30.00 | I | 72.00 | I | 17.5 | I | 0.608 | I | 38.797 | I |
| I | ARM B | I | 6.00 | I | 6.50 | I | 0.00 | I | 50.00 | I | 72.00 | I | 13.0 | I | 0.587 | I | 35.724 | I |
| I | ARM C | I | 3.50 | I | 9.00 | I | 38.00 | I | 22.50 | I | 72.00 | I | 40.0 | I | 0.558 | I | 35.585 | I |

V = approach half-width L = effective flare length D = inscribed circle diameter
E = entry width R = entry radius PHI = entry angle

WARNING ARM C: Effective flare length is outside normal range.
Treat capacities with increasing caution.

WARNING ARM A - INPUT VALUE OF V (7.30) OUTSIDE ACCEPTABLE RANGE -
HAS BEEN RESET AS INDICATED ABOVE (*). (AG17 REF. 6.3.1).

TRAFFIC DEMAND DATA

(Only sets included in the current run are shown)

| ARM | FLOW SCALE (%) |
|-----|----------------|
| A | 100 |
| B | 100 |
| C | 100 |

TIME PERIOD BEGINS 07.45 AND ENDS 09.15

LENGTH OF TIME PERIOD - 90 MINUTES.
 LENGTH OF TIME SEGMENT - 15 MINUTES.

DEMAND FLOW PROFILES ARE SYNTHESISED FROM TURNING COUNT DATA

DEMAND SET TITLE: B430 Roundabout - Junction 10 - 2013 Base + Gen AM

| ARM | NUMBER OF MINUTES FROM START WHEN FLOW STARTS TO RISE | TOP OF PEAK IS REACHED | FLOW STOPS IF FALLING | RATE OF FLOW (VEH/MIN) BEFORE PEAK | AT TOP OF PEAK | AFTER PEAK |
|-------|---|------------------------|-----------------------|------------------------------------|----------------|------------|
| ARM A | 15.00 | 45.00 | 75.00 | 17.06 | 25.59 | 17.06 |
| ARM B | 15.00 | 45.00 | 75.00 | 15.34 | 23.01 | 15.34 |
| ARM C | 15.00 | 45.00 | 75.00 | 8.24 | 12.36 | 8.24 |

DEMAND SET TITLE: B430 Roundabout - Junction 10 - 2013 Base + Gen AM

| TIME | TURNING PROPORTIONS | | | |
|---------------|---------------------|--------|--------|--------|
| | FROM/TO | ARM A | ARM B | ARM C |
| 07.45 - 09.15 | ARM A | 0.000 | 0.289 | 0.711 |
| | | (0.0) | (0.0) | (0.0) |
| | ARM B | 0.950 | 0.000 | 0.050 |
| | | 1166.0 | 0.0 | 61.0 |
| | | (0.0) | (0.0) | (0.0) |
| | ARM C | 0.590 | 0.410 | 0.000 |
| | | 389.0 | 270.0 | 0.0 |
| | | (0.0) | (0.0) | (0.0) |

QUEUE AND DELAY INFORMATION FOR EACH 15 MIN TIME SEGMENT

| TIME | DEMAND (VEH/MIN) | CAPACITY (VEH/MIN) | DEMAND/CAPACITY (RFC) | PEDESTRIAN FLOW (PEDS/MIN) | START QUEUE (VEHS) | END QUEUE (VEHS) | DELAY (VEH.MIN/TIME SEGMENT) | GEOMETRIC DELAY (VEH.MIN/TIME SEGMENT) | AVERAGE DELAY PER ARRIVING VEHICLE (MIN) |
|--|------------------|--------------------|-----------------------|----------------------------|-----------------------|------------------|------------------------------|--|--|
| 07.45-08.00 | | | | | | | | | |
| ARM A | 17.06 | 36.75 | 0.464 | | 0.0 | 0.9 | 12.6 | | 0.05 |
| ARM B | 15.34 | 28.63 | 0.536 | | 0.0 | 1.1 | 16.5 | | 0.07 |
| ARM C | 8.24 | 27.50 | 0.300 | | 0.0 | 0.4 | 6.3 | | 0.05 |
| EFFECT ON CAPACITY (PCU/MIN) OF MARGINAL CHANGES IN: | | | | | | | | | |
| | MARGINAL CHANGE: | ENTRY WIDTH (.1M) | FLARE LENGTH (M) | INSCRIBED CIRC DIAM (M) | ENTRY ANGLE (10 DEGS) | | | | |
| | ARM A | 0.518 | 0.000 | 0.016 | -1.202 | | | | |
| | ARM B | 0.488 | 0.000 | 0.057 | -0.911 | | | | |
| | ARM C | 0.198 | 0.133 | 0.064 | -0.981 | | | | |

| TIME | DEMAND (VEH/MIN) | CAPACITY (VEH/MIN) | DEMAND/ CAPACITY (RFC) | PEDESTRIAN FLOW (PEDS/MIN) | START QUEUE (VEHS) | END QUEUE (VEHS) | DELAY (VEH.MIN/ TIME SEGMENT) | GEOMETRIC DELAY (VEH.MIN/ TIME SEGMENT) | AVERAGE DELAY PER ARRIVING VEHICLE (MIN) |
|--|---------------------|-----------------------|------------------------------|----------------------------------|--------------------------|------------------------|-------------------------------------|---|--|
| 08.00-08.15 | | | | | | | | | |
| ARM A | 20.37 | 36.35 | 0.561 | | 0.9 | 1.3 | 18.5 | | 0.06 |
| ARM B | 18.31 | 27.24 | 0.672 | | 1.1 | 2.0 | 28.7 | | 0.11 |
| ARM C | 9.84 | 25.91 | 0.380 | | 0.4 | 0.6 | 8.9 | | 0.06 |
| EFFECT ON CAPACITY (PCU/MIN) OF MARGINAL CHANGES IN: | | | | | | | | | |
| | MARGINAL | ENTRY | FLARE | INSCRIBED | ENTRY | | | | |
| | CHANGE: | WIDTH | LENGTH | CIRC DIAM | ANGLE | | | | |
| | | (.1M) | (M) | (M) | (10 DEGS) | | | | |
| | ARM A | 0.515 | 0.000 | 0.020 | -1.189 | | | | |
| | ARM B | 0.476 | 0.000 | 0.068 | -0.867 | | | | |
| | ARM C | 0.192 | 0.129 | 0.077 | -0.924 | | | | |

| TIME | DEMAND (VEH/MIN) | CAPACITY (VEH/MIN) | DEMAND/ CAPACITY (RFC) | PEDESTRIAN FLOW (PEDS/MIN) | START QUEUE (VEHS) | END QUEUE (VEHS) | DELAY (VEH.MIN/ TIME SEGMENT) | GEOMETRIC DELAY (VEH.MIN/ TIME SEGMENT) | AVERAGE DELAY PER ARRIVING VEHICLE (MIN) |
|--|---------------------|-----------------------|------------------------------|----------------------------------|--------------------------|------------------------|-------------------------------------|---|--|
| 08.15-08.30 | | | | | | | | | |
| ARM A | 24.95 | 35.80 | 0.697 | | 1.3 | 2.3 | 32.3 | | 0.09 |
| ARM B | 22.43 | 25.34 | 0.885 | | 2.0 | 6.6 | 83.4 | | 0.29 |
| ARM C | 12.05 | 23.86 | 0.505 | | 0.6 | 1.0 | 14.7 | | 0.08 |
| EFFECT ON CAPACITY (PCU/MIN) OF MARGINAL CHANGES IN: | | | | | | | | | |
| | MARGINAL | ENTRY | FLARE | INSCRIBED | ENTRY | | | | |
| | CHANGE: | WIDTH | LENGTH | CIRC DIAM | ANGLE | | | | |
| | | (.1M) | (M) | (M) | (10 DEGS) | | | | |
| | ARM A | 0.511 | 0.000 | 0.024 | -1.171 | | | | |
| | ARM B | 0.459 | 0.000 | 0.083 | -0.806 | | | | |
| | ARM C | 0.184 | 0.124 | 0.093 | -0.851 | | | | |

| TIME | DEMAND (VEH/MIN) | CAPACITY (VEH/MIN) | DEMAND/ CAPACITY (RFC) | PEDESTRIAN FLOW (PEDS/MIN) | START QUEUE (VEHS) | END QUEUE (VEHS) | DELAY (VEH.MIN/ TIME SEGMENT) | GEOMETRIC DELAY (VEH.MIN/ TIME SEGMENT) | AVERAGE DELAY PER ARRIVING VEHICLE (MIN) |
|--|---------------------|-----------------------|------------------------------|----------------------------------|--------------------------|------------------------|-------------------------------------|---|--|
| 08.30-08.45 | | | | | | | | | |
| ARM A | 24.95 | 35.80 | 0.697 | | 2.3 | 2.3 | 34.0 | | 0.09 |
| ARM B | 22.43 | 25.31 | 0.886 | | 6.6 | 7.1 | 103.4 | | 0.33 |
| ARM C | 12.05 | 23.72 | 0.508 | | 1.0 | 1.0 | 15.3 | | 0.09 |
| EFFECT ON CAPACITY (PCU/MIN) OF MARGINAL CHANGES IN: | | | | | | | | | |
| | MARGINAL | ENTRY | FLARE | INSCRIBED | ENTRY | | | | |
| | CHANGE: | WIDTH | LENGTH | CIRC DIAM | ANGLE | | | | |
| | | (.1M) | (M) | (M) | (10 DEGS) | | | | |
| | ARM A | 0.511 | 0.000 | 0.024 | -1.170 | | | | |
| | ARM B | 0.459 | 0.000 | 0.083 | -0.805 | | | | |
| | ARM C | 0.184 | 0.123 | 0.095 | -0.846 | | | | |

| TIME | DEMAND (VEH/MIN) | CAPACITY (VEH/MIN) | DEMAND/ CAPACITY (RFC) | PEDESTRIAN FLOW (PEDS/MIN) | START QUEUE (VEHS) | END QUEUE (VEHS) | DELAY (VEH.MIN/ TIME SEGMENT) | GEOMETRIC DELAY (VEH.MIN/ TIME SEGMENT) | AVERAGE DELAY PER ARRIVING VEHICLE (MIN) |
|--|---------------------|-----------------------|------------------------------|----------------------------------|--------------------------|------------------------|-------------------------------------|---|--|
| 08.45-09.00 | | | | | | | | | |
| ARM A | 20.37 | 36.34 | 0.561 | | 2.3 | 1.3 | 19.9 | | 0.06 |
| ARM B | 18.31 | 27.20 | 0.673 | | 7.1 | 2.1 | 35.3 | | 0.12 |
| ARM C | 9.84 | 25.70 | 0.383 | | 1.0 | 0.6 | 9.6 | | 0.06 |
| EFFECT ON CAPACITY (PCU/MIN) OF MARGINAL CHANGES IN: | | | | | | | | | |
| | MARGINAL | ENTRY | FLARE | INSCRIBED | ENTRY | | | | |
| | CHANGE: | WIDTH | LENGTH | CIRC DIAM | ANGLE | | | | |
| | | (.1M) | (M) | (M) | (10 DEGS) | | | | |
| | ARM A | 0.515 | 0.000 | 0.020 | -1.188 | | | | |
| | ARM B | 0.475 | 0.000 | 0.068 | -0.865 | | | | |
| | ARM C | 0.191 | 0.128 | 0.079 | -0.917 | | | | |

| I | TIME | DEMAND (VEH/MIN) | CAPACITY (VEH/MIN) | DEMAND/ CAPACITY (RFC) | PEDESTRIAN FLOW (PEDS/MIN) | START QUEUE (VEHS) | END QUEUE (VEHS) | DELAY (VEH.MIN/ TIME SEGMENT) | GEOMETRIC DELAY (VEH.MIN/ TIME SEGMENT) | AVERAGE DELAY PER ARRIVING VEHICLE (MIN) | I | |
|---|-------------|--|-----------------------|------------------------------|----------------------------------|--------------------------|------------------------|-------------------------------------|---|--|---|---|
| I | 09.00-09.15 | | | | | | | | | | I | |
| I | ARM A | 17.06 | 36.74 | 0.464 | | 1.3 | 0.9 | 13.4 | | 0.05 | I | |
| I | ARM B | 15.34 | 28.59 | 0.536 | | 2.1 | 1.2 | 18.1 | | 0.08 | I | |
| I | ARM C | 8.24 | 27.42 | 0.300 | | 0.6 | 0.4 | 6.6 | | 0.05 | I | |
| I | | EFFECT ON CAPACITY (PCU/MIN) OF MARGINAL CHANGES IN: | | | | | | | | | | I |
| I | | | ENTRY | FLARE | INSCRIBED | ENTRY | | | | | I | |
| I | | MARGINAL | WIDTH | LENGTH | CIRC DIAM | ANGLE | | | | | I | |
| I | | CHANGE: | (.1M) | (M) | (M) | (10 DEGS) | | | | | I | |
| I | | ARM A | 0.518 | 0.000 | 0.016 | -1.201 | | | | | I | |
| I | | ARM B | 0.488 | 0.000 | 0.057 | -0.910 | | | | | I | |
| I | | ARM C | 0.198 | 0.133 | 0.065 | -0.978 | | | | | I | |

QUEUE AT ARM A

| TIME SEGMENT ENDING | NO. OF VEHICLES IN QUEUE | |
|------------------------|--------------------------------|----|
| 08.00 | 0.9 | * |
| 08.15 | 1.3 | * |
| 08.30 | 2.3 | ** |
| 08.45 | 2.3 | ** |
| 09.00 | 1.3 | * |
| 09.15 | 0.9 | * |

QUEUE AT ARM B

| TIME SEGMENT ENDING | NO. OF VEHICLES IN QUEUE | |
|------------------------|--------------------------------|-------|
| 08.00 | 1.1 | * |
| 08.15 | 2.0 | ** |
| 08.30 | 6.6 | ***** |
| 08.45 | 7.1 | ***** |
| 09.00 | 2.1 | ** |
| 09.15 | 1.2 | * |

QUEUE AT ARM C

| TIME SEGMENT ENDING | NO. OF VEHICLES IN QUEUE | |
|------------------------|--------------------------------|---|
| 08.00 | 0.4 | |
| 08.15 | 0.6 | * |
| 08.30 | 1.0 | * |
| 08.45 | 1.0 | * |
| 09.00 | 0.6 | * |
| 09.15 | 0.4 | |

 QUEUEING DELAY INFORMATION OVER WHOLE PERIOD

| I | ARM | TOTAL DEMAND | | * QUEUEING * | | * INCLUSIVE QUEUEING * | |
|---|-----|--------------|----------|--------------|-----------|------------------------|-----------|
| | | I | I | I | I | I | I |
| | | (VEH) | (VEH/H) | (MIN) | (MIN/VEH) | (MIN) | (MIN/VEH) |
| I | A | I 1871.7 | I 1247.8 | I 130.8 | I 0.07 | I 130.8 | I 0.07 |
| I | B | I 1682.5 | I 1121.7 | I 285.5 | I 0.17 | I 285.5 | I 0.17 |
| I | C | I 903.6 | I 602.4 | I 61.3 | I 0.07 | I 61.3 | I 0.07 |
| I | ALL | I 4457.8 | I 2971.9 | I 477.6 | I 0.11 | I 477.6 | I 0.11 |

* DELAY IS THAT OCCURRING ONLY WITHIN THE TIME PERIOD.
 * INCLUSIVE DELAY INCLUDES DELAY SUFFERED BY VEHICLES WHICH ARE STILL QUEUEING AFTER THE END OF THE TIME PERIOD.
 * THESE WILL ONLY BE SIGNIFICANTLY DIFFERENT IF THERE IS A LARGE QUEUE REMAINING AT THE END OF THE TIME PERIOD.

END OF JOB

===== end of file =====

ARCADY 6

ASSESSMENT OF ROUNDABOUT CAPACITY AND DELAY

Analysis Program: Release 3.0 (JUNE 2005)

(c) Copyright TRL Limited, 2004

Adapted from ARCADY/3 which is Crown Copyright by permission of the controller of HMSO

For sales and distribution information, program advice and maintenance, contact:

TRL Limited Tel: +44 (0) 1344 770018
Crowthorne House Fax: +44 (0) 1344 770864
Nine Mile Ride Email: softwarebureau@trl.co.uk
Wokingham, Berks. Web: www.trlsoftware.co.uk
RG40 3GA,UK

THE USER OF THIS COMPUTER PROGRAM FOR THE SOLUTION OF AN ENGINEERING PROBLEM IS IN NO WAY RELIEVED OF THEIR RESPONSIBILITY FOR THE CORRECTNESS OF THE SOLUTION

Run with file:-

"j:\120000\120669-00\4 Internal Project Data\4-04 Calculations\4-04-06 Junction Analysis\Arcady\2013 Base + Gen\PM\B430 Roundabout - 2013 Base + Gen PM.vai"
(drive-on-the-left) at 16:38:49 on Thursday, 2 August 2007

FILE PROPERTIES *****

RUN TITLE: B430 Roundabout - Junction 10 - 2013 Base + Gen PM
LOCATION: Oxfordshire
DATE: 28/07/2007
CLIENT: North Oxfordshire Consortium
ENUMERATOR: Paul Dickens
JOB NUMBER: 120669
STATUS:
DESCRIPTION:

INPUT DATA *****
ARM A - A43
ARM B - M40 Slips
ARM C - B430

GEOMETRIC DATA

Table with 15 columns: I ARM, I, V (M), I, E (M), I, L (M), I, R (M), I, D (M), I, PHI (DEG), I, SLOPE, I, INTERCEPT (PCU/MIN), I. Rows include data for ARM A, B, and C.

V = approach half-width L = effective flare length D = inscribed circle diameter
E = entry width R = entry radius PHI = entry angle

WARNING ARM C: Effective flare length is outside normal range.
Treat capacities with increasing caution.

WARNING ARM A - INPUT VALUE OF V (7.30) OUTSIDE ACCEPTABLE RANGE -
HAS BEEN RESET AS INDICATED ABOVE (*). (AG17 REF. 6.3.1).

TRAFFIC DEMAND DATA

(Only sets included in the current run are shown)

| ARM | FLOW SCALE (%) |
|-----|----------------|
| A | 100 |
| B | 100 |
| C | 100 |

TIME PERIOD BEGINS 16.45 AND ENDS 18.15

LENGTH OF TIME PERIOD - 90 MINUTES.
 LENGTH OF TIME SEGMENT - 15 MINUTES.

DEMAND FLOW PROFILES ARE SYNTHESISED FROM TURNING COUNT DATA

DEMAND SET TITLE: B430 Roundabout - Junction 10 - 2013 Base + Gen PM

| ARM | NUMBER OF MINUTES FROM START WHEN FLOW STARTS TO RISE | TOP OF PEAK IS REACHED | FLOW STOPS IF FALLING | RATE OF FLOW (VEH/MIN) BEFORE PEAK | AT TOP OF PEAK | AFTER PEAK |
|-------|---|------------------------|-----------------------|------------------------------------|----------------|------------|
| ARM A | 15.00 | 45.00 | 75.00 | 10.40 | 15.60 | 10.40 |
| ARM B | 15.00 | 45.00 | 75.00 | 19.09 | 28.63 | 19.09 |
| ARM C | 15.00 | 45.00 | 75.00 | 8.94 | 13.41 | 8.94 |

DEMAND SET TITLE: B430 Roundabout - Junction 10 - 2013 Base + Gen PM

| TIME | TURNING PROPORTIONS | | | TURNING COUNTS (VEH/HR) | | | (PERCENTAGE OF H.V.S) | | | |
|---------------|---------------------|-------|-------|-------------------------|--------|-------|-----------------------|-------|-------|-------|
| | FROM/TO | ARM A | ARM B | ARM C | ARM A | ARM B | ARM C | ARM A | ARM B | ARM C |
| 16.45 - 18.15 | ARM A | 0.001 | 0.343 | 0.656 | 1.0 | 285.0 | 546.0 | (0.0) | (0.0) | (0.0) |
| | ARM B | 0.950 | 0.000 | 0.050 | 1451.0 | 0.0 | 76.0 | (0.0) | (0.0) | (0.0) |
| | ARM C | 0.723 | 0.277 | 0.000 | 517.0 | 198.0 | 0.0 | (0.0) | (0.0) | (0.0) |

QUEUE AND DELAY INFORMATION FOR EACH 15 MIN TIME SEGMENT

| TIME | DEMAND (VEH/MIN) | CAPACITY (VEH/MIN) | DEMAND/CAPACITY (RFC) | PEDESTRIAN FLOW (PEDS/MIN) | START QUEUE (VEHS) | END QUEUE (VEHS) | DELAY (VEH.MIN/TIME SEGMENT) | GEOMETRIC DELAY (VEH.MIN/TIME SEGMENT) | AVERAGE DELAY PER ARRIVING VEHICLE (MIN) |
|--|------------------|--------------------|-----------------------|----------------------------|-----------------------|------------------|------------------------------|--|--|
| 16.45-17.00 | | | | | | | | | |
| ARM A | 10.40 | 37.30 | 0.279 | | 0.0 | 0.4 | 5.7 | | 0.04 |
| ARM B | 19.09 | 31.72 | 0.602 | | 0.0 | 1.5 | 21.4 | | 0.08 |
| ARM C | 8.94 | 25.52 | 0.350 | | 0.0 | 0.5 | 7.8 | | 0.06 |
| EFFECT ON CAPACITY (PCU/MIN) OF MARGINAL CHANGES IN: | | | | | | | | | |
| | MARGINAL CHANGE: | ENTRY WIDTH (.1M) | FLARE LENGTH (M) | INSCRIBED CIRC DIAM (M) | ENTRY ANGLE (10 DEGS) | | | | |
| | ARM A | 0.523 | 0.000 | 0.012 | -1.220 | | | | |
| | ARM B | 0.515 | 0.000 | 0.032 | -1.010 | | | | |
| | ARM C | 0.191 | 0.128 | 0.080 | -0.910 | | | | |

| TIME | DEMAND (VEH/MIN) | CAPACITY (VEH/MIN) | DEMAND/ CAPACITY (RFC) | PEDESTRIAN FLOW (PEDS/MIN) | START QUEUE (VEHS) | END QUEUE (VEHS) | DELAY (VEH.MIN/ TIME SEGMENT) | GEOMETRIC DELAY (VEH.MIN/ TIME SEGMENT) | AVERAGE DELAY PER ARRIVING VEHICLE (MIN) |
|--|---------------------|-----------------------|------------------------------|----------------------------------|--------------------------|------------------------|-------------------------------------|---|--|
| 17.00-17.15 | | | | | | | | | |
| ARM A | 12.42 | 37.00 | 0.336 | | 0.4 | 0.5 | 7.5 | | 0.04 |
| ARM B | 22.79 | 30.94 | 0.737 | | 1.5 | 2.7 | 38.4 | | 0.12 |
| ARM C | 10.67 | 23.54 | 0.453 | | 0.5 | 0.8 | 12.0 | | 0.08 |
| EFFECT ON CAPACITY (PCU/MIN) OF MARGINAL CHANGES IN: | | | | | | | | | |
| | MARGINAL | ENTRY | FLARE | INSCRIBED | ENTRY | | | | |
| | CHANGE: | WIDTH | LENGTH | CIRC DIAM | ANGLE | | | | |
| | | (.1M) | (M) | (M) | (10 DEGS) | | | | |
| | ARM A | 0.520 | 0.000 | 0.014 | -1.210 | | | | |
| | ARM B | 0.508 | 0.000 | 0.038 | -0.985 | | | | |
| | ARM C | 0.183 | 0.123 | 0.096 | -0.840 | | | | |

| TIME | DEMAND (VEH/MIN) | CAPACITY (VEH/MIN) | DEMAND/ CAPACITY (RFC) | PEDESTRIAN FLOW (PEDS/MIN) | START QUEUE (VEHS) | END QUEUE (VEHS) | DELAY (VEH.MIN/ TIME SEGMENT) | GEOMETRIC DELAY (VEH.MIN/ TIME SEGMENT) | AVERAGE DELAY PER ARRIVING VEHICLE (MIN) |
|--|---------------------|-----------------------|------------------------------|----------------------------------|--------------------------|------------------------|-------------------------------------|---|--|
| 17.15-17.30 | | | | | | | | | |
| ARM A | 15.21 | 36.61 | 0.416 | | 0.5 | 0.7 | 10.4 | | 0.05 |
| ARM B | 27.91 | 29.86 | 0.935 | | 2.7 | 10.4 | 123.5 | | 0.35 |
| ARM C | 13.07 | 21.06 | 0.621 | | 0.8 | 1.6 | 22.9 | | 0.12 |
| EFFECT ON CAPACITY (PCU/MIN) OF MARGINAL CHANGES IN: | | | | | | | | | |
| | MARGINAL | ENTRY | FLARE | INSCRIBED | ENTRY | | | | |
| | CHANGE: | WIDTH | LENGTH | CIRC DIAM | ANGLE | | | | |
| | | (.1M) | (M) | (M) | (10 DEGS) | | | | |
| | ARM A | 0.517 | 0.000 | 0.017 | -1.197 | | | | |
| | ARM B | 0.499 | 0.000 | 0.047 | -0.951 | | | | |
| | ARM C | 0.174 | 0.116 | 0.116 | -0.751 | | | | |

| TIME | DEMAND (VEH/MIN) | CAPACITY (VEH/MIN) | DEMAND/ CAPACITY (RFC) | PEDESTRIAN FLOW (PEDS/MIN) | START QUEUE (VEHS) | END QUEUE (VEHS) | DELAY (VEH.MIN/ TIME SEGMENT) | GEOMETRIC DELAY (VEH.MIN/ TIME SEGMENT) | AVERAGE DELAY PER ARRIVING VEHICLE (MIN) |
|--|---------------------|-----------------------|------------------------------|----------------------------------|--------------------------|------------------------|-------------------------------------|---|--|
| 17.30-17.45 | | | | | | | | | |
| ARM A | 15.21 | 36.60 | 0.416 | | 0.7 | 0.7 | 10.6 | | 0.05 |
| ARM B | 27.91 | 29.86 | 0.935 | | 10.4 | 11.8 | 168.0 | | 0.45 |
| ARM C | 13.07 | 20.83 | 0.627 | | 1.6 | 1.7 | 24.6 | | 0.13 |
| EFFECT ON CAPACITY (PCU/MIN) OF MARGINAL CHANGES IN: | | | | | | | | | |
| | MARGINAL | ENTRY | FLARE | INSCRIBED | ENTRY | | | | |
| | CHANGE: | WIDTH | LENGTH | CIRC DIAM | ANGLE | | | | |
| | | (.1M) | (M) | (M) | (10 DEGS) | | | | |
| | ARM A | 0.517 | 0.000 | 0.018 | -1.197 | | | | |
| | ARM B | 0.499 | 0.000 | 0.047 | -0.950 | | | | |
| | ARM C | 0.173 | 0.116 | 0.118 | -0.743 | | | | |

| TIME | DEMAND (VEH/MIN) | CAPACITY (VEH/MIN) | DEMAND/ CAPACITY (RFC) | PEDESTRIAN FLOW (PEDS/MIN) | START QUEUE (VEHS) | END QUEUE (VEHS) | DELAY (VEH.MIN/ TIME SEGMENT) | GEOMETRIC DELAY (VEH.MIN/ TIME SEGMENT) | AVERAGE DELAY PER ARRIVING VEHICLE (MIN) |
|--|---------------------|-----------------------|------------------------------|----------------------------------|--------------------------|------------------------|-------------------------------------|---|--|
| 17.45-18.00 | | | | | | | | | |
| ARM A | 12.42 | 36.99 | 0.336 | | 0.7 | 0.5 | 7.7 | | 0.04 |
| ARM B | 22.79 | 30.93 | 0.737 | | 11.8 | 2.9 | 52.4 | | 0.14 |
| ARM C | 10.67 | 23.18 | 0.460 | | 1.7 | 0.9 | 13.3 | | 0.08 |
| EFFECT ON CAPACITY (PCU/MIN) OF MARGINAL CHANGES IN: | | | | | | | | | |
| | MARGINAL | ENTRY | FLARE | INSCRIBED | ENTRY | | | | |
| | CHANGE: | WIDTH | LENGTH | CIRC DIAM | ANGLE | | | | |
| | | (.1M) | (M) | (M) | (10 DEGS) | | | | |
| | ARM A | 0.520 | 0.000 | 0.014 | -1.210 | | | | |
| | ARM B | 0.508 | 0.000 | 0.038 | -0.985 | | | | |
| | ARM C | 0.182 | 0.122 | 0.099 | -0.827 | | | | |

| TIME | DEMAND (VEH/MIN) | CAPACITY (VEH/MIN) | DEMAND/ CAPACITY (RFC) | PEDESTRIAN FLOW (PEDS/MIN) | START QUEUE (VEHS) | END QUEUE (VEHS) | DELAY (VEH.MIN/ TIME SEGMENT) | GEOMETRIC DELAY (VEH.MIN/ TIME SEGMENT) | AVERAGE DELAY PER ARRIVING VEHICLE (MIN) |
|--|---------------------|-------------------------|------------------------------|----------------------------------|-----------------------------|------------------------|-------------------------------------|---|--|
| 18.00-18.15 | | | | | | | | | |
| ARM A | 10.40 | 37.29 | 0.279 | | 0.5 | 0.4 | 5.9 | | 0.04 |
| ARM B | 19.09 | 31.71 | 0.602 | | 2.9 | 1.5 | 23.9 | | 0.08 |
| ARM C | 8.94 | 25.42 | 0.352 | | 0.9 | 0.5 | 8.4 | | 0.06 |
| EFFECT ON CAPACITY (PCU/MIN) OF MARGINAL CHANGES IN: | | | | | | | | | |
| | MARGINAL CHANGE: | ENTRY WIDTH (.1M) | FLARE LENGTH (M) | INSCRIBED CIRC DIAM (M) | ENTRY ANGLE (10 DEGS) | | | | |
| | ARM A | 0.523 | 0.000 | 0.012 | -1.219 | | | | |
| | ARM B | 0.515 | 0.000 | 0.032 | -1.009 | | | | |
| | ARM C | 0.190 | 0.127 | 0.081 | -0.907 | | | | |

QUEUE AT ARM A

| TIME SEGMENT ENDING | NO. OF VEHICLES IN QUEUE |
|------------------------|--------------------------------|
| 17.00 | 0.4 |
| 17.15 | 0.5 * |
| 17.30 | 0.7 * |
| 17.45 | 0.7 * |
| 18.00 | 0.5 * |
| 18.15 | 0.4 |

QUEUE AT ARM B

| TIME SEGMENT ENDING | NO. OF VEHICLES IN QUEUE |
|------------------------|--------------------------------|
| 17.00 | 1.5 * |
| 17.15 | 2.7 *** |
| 17.30 | 10.4 ***** |
| 17.45 | 11.8 ***** |
| 18.00 | 2.9 *** |
| 18.15 | 1.5 ** |

QUEUE AT ARM C

| TIME SEGMENT ENDING | NO. OF VEHICLES IN QUEUE |
|------------------------|--------------------------------|
| 17.00 | 0.5 * |
| 17.15 | 0.8 * |
| 17.30 | 1.6 ** |
| 17.45 | 1.7 ** |
| 18.00 | 0.9 * |
| 18.15 | 0.5 * |

 QUEUEING DELAY INFORMATION OVER WHOLE PERIOD

| I | ARM | I | TOTAL DEMAND | | * QUEUEING * | | * INCLUSIVE QUEUEING * | |
|---|-----|---|--------------|----------|--------------|-----------|------------------------|-----------|
| | | | I | I | I | I | I | I |
| | | | (VEH) | (VEH/H) | (MIN) | (MIN/VEH) | (MIN) | (MIN/VEH) |
| I | A | I | 1140.8 | I 760.6 | I 47.8 | I 0.04 | I 47.8 | I 0.04 |
| I | B | I | 2093.8 | I 1395.9 | I 427.7 | I 0.20 | I 427.7 | I 0.20 |
| I | C | I | 980.4 | I 653.6 | I 89.0 | I 0.09 | I 89.0 | I 0.09 |
| I | ALL | I | 4215.1 | I 2810.1 | I 564.5 | I 0.13 | I 564.6 | I 0.13 |

* DELAY IS THAT OCCURRING ONLY WITHIN THE TIME PERIOD.
 * INCLUSIVE DELAY INCLUDES DELAY SUFFERED BY VEHICLES WHICH ARE STILL QUEUEING AFTER THE END OF THE TIME PERIOD.
 * THESE WILL ONLY BE SIGNIFICANTLY DIFFERENT IF THERE IS A LARGE QUEUE REMAINING AT THE END OF THE TIME PERIOD.

END OF JOB

===== end of file =====

ARCADY 6

ASSESSMENT OF ROUNDABOUT CAPACITY AND DELAY

Analysis Program: Release 3.0 (JUNE 2005)

(c) Copyright TRL Limited, 2004

Adapted from ARCADY/3 which is Crown Copyright
by permission of the controller of HMSO

For sales and distribution information,
program advice and maintenance, contact:

TRL Limited Tel: +44 (0) 1344 770018
Crowthorne House Fax: +44 (0) 1344 770864
Nine Mile Ride Email: softwarebureau@trl.co.uk
Wokingham, Berks. Web: www.trlsoftware.co.uk
RG40 3GA,UK

THE USER OF THIS COMPUTER PROGRAM FOR THE SOLUTION OF AN ENGINEERING PROBLEM IS
IN NO WAY RELIEVED OF THEIR RESPONSIBILITY FOR THE CORRECTNESS OF THE SOLUTION

Run with file:-

"j:\120000\120669-00\4 Internal Project Data\4-04 Calculations\4-04-06 Junction Analysis\Arcady\2028 Base\AM\
B430 Roundabout - 2028 Base AM.vai"
(drive-on-the-left) at 09:45:16 on Friday, 3 August 2007

FILE PROPERTIES

RUN TITLE: B430 Roundabout - Junction 10 - 2028 Base AM
LOCATION: Oxfordshire
DATE: 03/08/2007
CLIENT: North Oxfordshire Consortium
ENUMERATOR: Paul Dickens
JOB NUMBER: 120669
STATUS:
DESCRIPTION:

INPUT DATA

ARM A - A43
ARM B - M40 Slips
ARM C - B430

GEOMETRIC DATA

| I | ARM | I | V (M) | I | E (M) | I | L (M) | I | R (M) | I | D (M) | I | PHI (DEG) | I | SLOPE | I | INTERCEPT (PCU/MIN) | I |
|---|-------|---|--------|---|-------|---|-------|---|-------|---|-------|---|-----------|---|-------|---|---------------------|---|
| I | ARM A | I | 7.25 * | I | 7.25 | I | 0.00 | I | 30.00 | I | 72.00 | I | 17.5 | I | 0.608 | I | 38.797 | I |
| I | ARM B | I | 6.00 | I | 6.50 | I | 0.00 | I | 50.00 | I | 72.00 | I | 13.0 | I | 0.587 | I | 35.724 | I |
| I | ARM C | I | 3.50 | I | 9.00 | I | 38.00 | I | 22.50 | I | 72.00 | I | 40.0 | I | 0.558 | I | 35.585 | I |

V = approach half-width L = effective flare length D = inscribed circle diameter
E = entry width R = entry radius PHI = entry angle

WARNING ARM C: Effective flare length is outside normal range.
Treat capacities with increasing caution.

WARNING ARM A - INPUT VALUE OF V (7.30) OUTSIDE ACCEPTABLE RANGE -
HAS BEEN RESET AS INDICATED ABOVE (*). (AG17 REF. 6.3.1).

TRAFFIC DEMAND DATA

(Only sets included in the current run are shown)

| ARM | FLOW SCALE (%) |
|-----|----------------|
| A | 100 |
| B | 100 |
| C | 100 |

TIME PERIOD BEGINS 07.45 AND ENDS 09.15

LENGTH OF TIME PERIOD - 90 MINUTES.
 LENGTH OF TIME SEGMENT - 15 MINUTES.

DEMAND FLOW PROFILES ARE SYNTHESISED FROM TURNING COUNT DATA

DEMAND SET TITLE: B430 Roundabout - Junction 10 - 2028 Base AM

| ARM | NUMBER OF MINUTES FROM START WHEN FLOW STARTS TO RISE | TOP OF PEAK IS REACHED | FLOW STOPS IF FALLING | RATE OF FLOW (VEH/MIN) BEFORE PEAK | AT TOP OF PEAK | AFTER PEAK |
|-------|---|------------------------|-----------------------|------------------------------------|----------------|------------|
| ARM A | 15.00 | 45.00 | 75.00 | 14.39 | 21.58 | 14.39 |
| ARM B | 15.00 | 45.00 | 75.00 | 16.20 | 24.30 | 16.20 |
| ARM C | 15.00 | 45.00 | 75.00 | 5.45 | 8.17 | 5.45 |

DEMAND SET TITLE: B430 Roundabout - Junction 10 - 2028 Base AM

| TIME | TURNING PROPORTIONS | | | TURNING COUNTS (VEH/HR) | | |
|---------------|---------------------|-------|-------|-------------------------|-----------------------|----------|
| | FROM/TO | ARM A | ARM B | ARM C | (PERCENTAGE OF H.V.S) | (VEH/HR) |
| 07.45 - 09.15 | ARM A | 0.000 | 0.373 | 0.627 | (0.0) | (0.0) |
| | ARM B | 0.980 | 0.000 | 0.020 | (0.0) | (0.0) |
| | ARM C | 0.489 | 0.511 | 0.000 | (0.0) | (0.0) |

QUEUE AND DELAY INFORMATION FOR EACH 15 MIN TIME SEGMENT

| TIME | DEMAND (VEH/MIN) | CAPACITY (VEH/MIN) | DEMAND/CAPACITY (RFC) | PEDESTRIAN FLOW (PEDS/MIN) | START QUEUE (VEHS) | END QUEUE (VEHS) | DELAY (VEH.MIN/TIME SEGMENT) | GEOMETRIC DELAY (VEH.MIN/TIME SEGMENT) | AVERAGE DELAY PER ARRIVING VEHICLE (MIN) |
|--|------------------|--------------------|-----------------------|----------------------------|-----------------------|------------------|------------------------------|--|--|
| 07.45-08.00 | | | | | | | | | |
| ARM A | 14.39 | 37.11 | 0.388 | | 0.0 | 0.6 | 9.3 | | 0.04 |
| ARM B | 16.20 | 30.45 | 0.532 | | 0.0 | 1.1 | 16.3 | | 0.07 |
| ARM C | 5.45 | 26.77 | 0.204 | | 0.0 | 0.3 | 3.8 | | 0.05 |
| EFFECT ON CAPACITY (PCU/MIN) OF MARGINAL CHANGES IN: | | | | | | | | | |
| | MARGINAL CHANGE: | ENTRY WIDTH (.1M) | FLARE LENGTH (M) | INSCRIBED CIRC DIAM (M) | ENTRY ANGLE (10 DEGS) | | | | |
| | ARM A | 0.521 | 0.000 | 0.013 | -1.213 | | | | |
| | ARM B | 0.504 | 0.000 | 0.042 | -0.969 | | | | |
| | ARM C | 0.195 | 0.131 | 0.070 | -0.955 | | | | |

| TIME | DEMAND (VEH/MIN) | CAPACITY (VEH/MIN) | DEMAND/ CAPACITY (RFC) | PEDESTRIAN FLOW (PEDS/MIN) | START QUEUE (VEHS) | END QUEUE (VEHS) | DELAY (VEH.MIN/ TIME SEGMENT) | GEOMETRIC DELAY (VEH.MIN/ TIME SEGMENT) | AVERAGE DELAY PER ARRIVING VEHICLE (MIN) |
|--|---------------------|-----------------------|------------------------------|----------------------------------|--------------------------|------------------------|-------------------------------------|---|--|
| 08.00-08.15 | | | | | | | | | |
| ARM A | 17.18 | 36.77 | 0.467 | | 0.6 | 0.9 | 12.8 | | 0.05 |
| ARM B | 19.34 | 29.41 | 0.658 | | 1.1 | 1.9 | 27.1 | | 0.10 |
| ARM C | 6.51 | 25.04 | 0.260 | | 0.3 | 0.3 | 5.2 | | 0.05 |
| EFFECT ON CAPACITY (PCU/MIN) OF MARGINAL CHANGES IN: | | | | | | | | | |
| | MARGINAL | ENTRY | FLARE | INSCRIBED | ENTRY | | | | |
| | CHANGE: | WIDTH | LENGTH | CIRC DIAM | ANGLE | | | | |
| | | (.1M) | (M) | (M) | (10 DEGS) | | | | |
| | ARM A | 0.519 | 0.000 | 0.016 | -1.202 | | | | |
| | ARM B | 0.495 | 0.000 | 0.050 | -0.936 | | | | |
| | ARM C | 0.189 | 0.127 | 0.084 | -0.893 | | | | |

| TIME | DEMAND (VEH/MIN) | CAPACITY (VEH/MIN) | DEMAND/ CAPACITY (RFC) | PEDESTRIAN FLOW (PEDS/MIN) | START QUEUE (VEHS) | END QUEUE (VEHS) | DELAY (VEH.MIN/ TIME SEGMENT) | GEOMETRIC DELAY (VEH.MIN/ TIME SEGMENT) | AVERAGE DELAY PER ARRIVING VEHICLE (MIN) |
|--|---------------------|-----------------------|------------------------------|----------------------------------|--------------------------|------------------------|-------------------------------------|---|--|
| 08.15-08.30 | | | | | | | | | |
| ARM A | 21.04 | 36.32 | 0.579 | | 0.9 | 1.4 | 19.9 | | 0.07 |
| ARM B | 23.69 | 28.00 | 0.846 | | 1.9 | 5.0 | 66.9 | | 0.21 |
| ARM C | 7.97 | 22.75 | 0.350 | | 0.3 | 0.5 | 7.9 | | 0.07 |
| EFFECT ON CAPACITY (PCU/MIN) OF MARGINAL CHANGES IN: | | | | | | | | | |
| | MARGINAL | ENTRY | FLARE | INSCRIBED | ENTRY | | | | |
| | CHANGE: | WIDTH | LENGTH | CIRC DIAM | ANGLE | | | | |
| | | (.1M) | (M) | (M) | (10 DEGS) | | | | |
| | ARM A | 0.515 | 0.000 | 0.020 | -1.188 | | | | |
| | ARM B | 0.482 | 0.000 | 0.062 | -0.891 | | | | |
| | ARM C | 0.180 | 0.121 | 0.102 | -0.811 | | | | |

| TIME | DEMAND (VEH/MIN) | CAPACITY (VEH/MIN) | DEMAND/ CAPACITY (RFC) | PEDESTRIAN FLOW (PEDS/MIN) | START QUEUE (VEHS) | END QUEUE (VEHS) | DELAY (VEH.MIN/ TIME SEGMENT) | GEOMETRIC DELAY (VEH.MIN/ TIME SEGMENT) | AVERAGE DELAY PER ARRIVING VEHICLE (MIN) |
|--|---------------------|-----------------------|------------------------------|----------------------------------|--------------------------|------------------------|-------------------------------------|---|--|
| 08.30-08.45 | | | | | | | | | |
| ARM A | 21.04 | 36.32 | 0.579 | | 1.4 | 1.4 | 20.5 | | 0.07 |
| ARM B | 23.69 | 27.98 | 0.847 | | 5.0 | 5.3 | 77.6 | | 0.23 |
| ARM C | 7.97 | 22.65 | 0.352 | | 0.5 | 0.5 | 8.1 | | 0.07 |
| EFFECT ON CAPACITY (PCU/MIN) OF MARGINAL CHANGES IN: | | | | | | | | | |
| | MARGINAL | ENTRY | FLARE | INSCRIBED | ENTRY | | | | |
| | CHANGE: | WIDTH | LENGTH | CIRC DIAM | ANGLE | | | | |
| | | (.1M) | (M) | (M) | (10 DEGS) | | | | |
| | ARM A | 0.515 | 0.000 | 0.020 | -1.188 | | | | |
| | ARM B | 0.482 | 0.000 | 0.062 | -0.891 | | | | |
| | ARM C | 0.180 | 0.120 | 0.103 | -0.808 | | | | |

| TIME | DEMAND (VEH/MIN) | CAPACITY (VEH/MIN) | DEMAND/ CAPACITY (RFC) | PEDESTRIAN FLOW (PEDS/MIN) | START QUEUE (VEHS) | END QUEUE (VEHS) | DELAY (VEH.MIN/ TIME SEGMENT) | GEOMETRIC DELAY (VEH.MIN/ TIME SEGMENT) | AVERAGE DELAY PER ARRIVING VEHICLE (MIN) |
|--|---------------------|-----------------------|------------------------------|----------------------------------|--------------------------|------------------------|-------------------------------------|---|--|
| 08.45-09.00 | | | | | | | | | |
| ARM A | 17.18 | 36.77 | 0.467 | | 1.4 | 0.9 | 13.5 | | 0.05 |
| ARM B | 19.34 | 29.39 | 0.658 | | 5.3 | 2.0 | 31.6 | | 0.10 |
| ARM C | 6.51 | 24.89 | 0.261 | | 0.5 | 0.4 | 5.4 | | 0.05 |
| EFFECT ON CAPACITY (PCU/MIN) OF MARGINAL CHANGES IN: | | | | | | | | | |
| | MARGINAL | ENTRY | FLARE | INSCRIBED | ENTRY | | | | |
| | CHANGE: | WIDTH | LENGTH | CIRC DIAM | ANGLE | | | | |
| | | (.1M) | (M) | (M) | (10 DEGS) | | | | |
| | ARM A | 0.519 | 0.000 | 0.016 | -1.202 | | | | |
| | ARM B | 0.495 | 0.000 | 0.050 | -0.936 | | | | |
| | ARM C | 0.188 | 0.126 | 0.085 | -0.888 | | | | |

 QUEUEING DELAY INFORMATION OVER WHOLE PERIOD

| I | ARM | I | TOTAL DEMAND | | I | * QUEUEING * | | I | * INCLUSIVE QUEUEING * | | I |
|---|-----|---|--------------|----------|---|--------------|-----------|---|------------------------|-----------|---|
| I | | I | | I | I | * DELAY * | | I | * DELAY * | | I |
| I | | I | (VEH) | (VEH/H) | I | (MIN) | (MIN/VEH) | I | (MIN) | (MIN/VEH) | I |
| I | A | I | 1578.3 | I 1052.2 | I | 85.7 | I 0.05 | I | 85.7 | I 0.05 | I |
| I | B | I | 1777.1 | I 1184.7 | I | 237.4 | I 0.13 | I | 237.4 | I 0.13 | I |
| I | C | I | 597.8 | I 398.6 | I | 34.2 | I 0.06 | I | 34.2 | I 0.06 | I |
| I | ALL | I | 3953.2 | I 2635.5 | I | 357.4 | I 0.09 | I | 357.4 | I 0.09 | I |

* DELAY IS THAT OCCURRING ONLY WITHIN THE TIME PERIOD.
 * INCLUSIVE DELAY INCLUDES DELAY SUFFERED BY VEHICLES WHICH ARE STILL QUEUEING AFTER THE END OF THE TIME PERIOD.
 * THESE WILL ONLY BE SIGNIFICANTLY DIFFERENT IF THERE IS A LARGE QUEUE REMAINING AT THE END OF THE TIME PERIOD.

END OF JOB

===== end of file =====

ARCADY 6

ASSESSMENT OF ROUNDABOUT CAPACITY AND DELAY

Analysis Program: Release 3.0 (JUNE 2005)

(c) Copyright TRL Limited, 2004

Adapted from ARCADY/3 which is Crown Copyright
by permission of the controller of HMSO

For sales and distribution information,
program advice and maintenance, contact:

TRL Limited Tel: +44 (0) 1344 770018
Crowthorne House Fax: +44 (0) 1344 770864
Nine Mile Ride Email: softwarebureau@trl.co.uk
Wokingham, Berks. Web: www.trlsoftware.co.uk
RG40 3GA,UK

THE USER OF THIS COMPUTER PROGRAM FOR THE SOLUTION OF AN ENGINEERING PROBLEM IS
IN NO WAY RELIEVED OF THEIR RESPONSIBILITY FOR THE CORRECTNESS OF THE SOLUTION

Run with file:-

"j:\120000\120669-00\4 Internal Project Data\4-04 Calculations\4-04-06 Junction Analysis\Arcady\2028 Base\PM\
B430 Roundabout - 2028 Base PM.vai"
(drive-on-the-left) at 09:39:23 on Friday, 3 August 2007

FILE PROPERTIES

RUN TITLE: B430 Roundabout - Junction 10 - 2028 Base PM
LOCATION: Oxfordshire
DATE: 03/08/2007
CLIENT: North Oxfordshire Consortium
ENUMERATOR: Paul Dickens
JOB NUMBER: 120669
STATUS:
DESCRIPTION:

INPUT DATA

ARM A - A43
ARM B - M40 Slips
ARM C - B430

GEOMETRIC DATA

| I | ARM | I | V (M) | I | E (M) | I | L (M) | I | R (M) | I | D (M) | I | PHI (DEG) | I | SLOPE | I | INTERCEPT (PCU/MIN) | I |
|---|-------|---|--------|---|-------|---|-------|---|-------|---|-------|---|-----------|---|-------|---|---------------------|---|
| I | ARM A | I | 7.25 * | I | 7.25 | I | 0.00 | I | 30.00 | I | 72.00 | I | 17.5 | I | 0.608 | I | 38.797 | I |
| I | ARM B | I | 6.00 | I | 6.50 | I | 0.00 | I | 50.00 | I | 72.00 | I | 13.0 | I | 0.587 | I | 35.724 | I |
| I | ARM C | I | 3.50 | I | 9.00 | I | 38.00 | I | 22.50 | I | 72.00 | I | 40.0 | I | 0.558 | I | 35.585 | I |

V = approach half-width L = effective flare length D = inscribed circle diameter
E = entry width R = entry radius PHI = entry angle

WARNING ARM C: Effective flare length is outside normal range.
Treat capacities with increasing caution.

WARNING ARM A - INPUT VALUE OF V (7.30) OUTSIDE ACCEPTABLE RANGE -
HAS BEEN RESET AS INDICATED ABOVE (*). (AG17 REF. 6.3.1).

TRAFFIC DEMAND DATA

(Only sets included in the current run are shown)

| ARM | FLOW SCALE (%) |
|-----|----------------|
| A | 100 |
| B | 100 |
| C | 100 |

TIME PERIOD BEGINS 16.45 AND ENDS 18.15

LENGTH OF TIME PERIOD - 90 MINUTES.
 LENGTH OF TIME SEGMENT - 15 MINUTES.

DEMAND FLOW PROFILES ARE SYNTHESISED FROM TURNING COUNT DATA

DEMAND SET TITLE: B430 Roundabout - Junction 10 - 2028 Base PM

| ARM | NUMBER OF MINUTES FROM START WHEN FLOW STARTS TO RISE | TOP OF PEAK IS REACHED | FLOW STOPS FALLING | RATE OF FLOW (VEH/MIN) BEFORE PEAK | AT TOP OF PEAK | AFTER PEAK |
|-------|---|------------------------|--------------------|------------------------------------|----------------|------------|
| ARM A | 15.00 | 45.00 | 75.00 | 8.51 | 12.77 | 8.51 |
| ARM B | 15.00 | 45.00 | 75.00 | 20.59 | 30.88 | 20.59 |
| ARM C | 15.00 | 45.00 | 75.00 | 5.05 | 7.58 | 5.05 |

DEMAND SET TITLE: B430 Roundabout - Junction 10 - 2028 Base PM

| TIME | TURNING PROPORTIONS | | | TURNING COUNTS (VEH/HR) | | | (PERCENTAGE OF H.V.S) | | | |
|---------------|---------------------|-------|-------|-------------------------|--------|-------|-----------------------|--------|--------|--------|
| | FROM/TO | ARM A | ARM B | ARM C | ARM A | ARM B | ARM C | ARM A | ARM B | ARM C |
| 16.45 - 18.15 | ARM A | 0.001 | 0.460 | 0.539 | 1.0 | 313.0 | 367.0 | (0.0) | (0.0) | (0.0) |
| | ARM B | 0.966 | 0.000 | 0.034 | 1591.0 | 0.0 | 56.0 | (0.0) | (0.0) | (0.0) |
| | ARM C | 0.700 | 0.300 | 0.000 | 283.0 | 121.0 | 0.0 | (0.0) | (0.0) | (0.0) |

QUEUE AND DELAY INFORMATION FOR EACH 15 MIN TIME SEGMENT

| TIME | DEMAND (VEH/MIN) | CAPACITY (VEH/MIN) | DEMAND/CAPACITY (RFC) | PEDESTRIAN FLOW (PEDS/MIN) | START QUEUE (VEHS) | END QUEUE (VEHS) | DELAY (VEH.MIN/TIME SEGMENT) | GEOMETRIC DELAY (VEH.MIN/TIME SEGMENT) | AVERAGE DELAY PER ARRIVING VEHICLE (MIN) |
|--|------------------|--------------------|-----------------------|----------------------------|-----------------------|------------------|------------------------------|--|--|
| 16.45-17.00 | | | | | | | | | |
| ARM A | 8.51 | 37.88 | 0.225 | | 0.0 | 0.3 | 4.3 | | 0.03 |
| ARM B | 20.59 | 33.03 | 0.623 | | 0.0 | 1.6 | 23.4 | | 0.08 |
| ARM C | 5.05 | 24.55 | 0.206 | | 0.0 | 0.3 | 3.8 | | 0.05 |
| EFFECT ON CAPACITY (PCU/MIN) OF MARGINAL CHANGES IN: | | | | | | | | | |
| | MARGINAL CHANGE: | ENTRY WIDTH (.1M) | FLARE LENGTH (M) | INSCRIBED CIRC DIAM (M) | ENTRY ANGLE (10 DEGS) | | | | |
| | ARM A | 0.528 | 0.000 | 0.007 | -1.239 | | | | |
| | ARM B | 0.526 | 0.000 | 0.021 | -1.052 | | | | |
| | ARM C | 0.187 | 0.125 | 0.088 | -0.876 | | | | |

| TIME | DEMAND (VEH/MIN) | CAPACITY (VEH/MIN) | DEMAND/ CAPACITY (RFC) | PEDESTRIAN FLOW (PEDS/MIN) | START QUEUE (VEHS) | END QUEUE (VEHS) | DELAY (VEH.MIN/ TIME SEGMENT) | GEOMETRIC DELAY (VEH.MIN/ TIME SEGMENT) | AVERAGE DELAY PER ARRIVING VEHICLE (MIN) |
|--|---------------------|-----------------------|------------------------------|----------------------------------|--------------------------|------------------------|-------------------------------------|---|--|
| 17.00-17.15 | | | | | | | | | |
| ARM A | 10.16 | 37.70 | 0.270 | | 0.3 | 0.4 | 5.5 | | 0.04 |
| ARM B | 24.58 | 32.50 | 0.756 | | 1.6 | 3.0 | 42.3 | | 0.12 |
| ARM C | 6.03 | 22.38 | 0.269 | | 0.3 | 0.4 | 5.4 | | 0.06 |
| EFFECT ON CAPACITY (PCU/MIN) OF MARGINAL CHANGES IN: | | | | | | | | | |
| | MARGINAL | ENTRY | FLARE | INSCRIBED | ENTRY | | | | |
| | CHANGE: | WIDTH | LENGTH | CIRC DIAM | ANGLE | | | | |
| | | (.1M) | (M) | (M) | (10 DEGS) | | | | |
| | ARM A | 0.526 | 0.000 | 0.009 | -1.233 | | | | |
| | ARM B | 0.522 | 0.000 | 0.026 | -1.035 | | | | |
| | ARM C | 0.179 | 0.120 | 0.105 | -0.798 | | | | |

| TIME | DEMAND (VEH/MIN) | CAPACITY (VEH/MIN) | DEMAND/ CAPACITY (RFC) | PEDESTRIAN FLOW (PEDS/MIN) | START QUEUE (VEHS) | END QUEUE (VEHS) | DELAY (VEH.MIN/ TIME SEGMENT) | GEOMETRIC DELAY (VEH.MIN/ TIME SEGMENT) | AVERAGE DELAY PER ARRIVING VEHICLE (MIN) |
|--|---------------------|-----------------------|------------------------------|----------------------------------|--------------------------|------------------------|-------------------------------------|---|--|
| 17.15-17.30 | | | | | | | | | |
| ARM A | 12.45 | 37.45 | 0.332 | | 0.4 | 0.5 | 7.3 | | 0.04 |
| ARM B | 30.11 | 31.78 | 0.947 | | 3.0 | 12.0 | 139.5 | | 0.37 |
| ARM C | 7.39 | 19.68 | 0.375 | | 0.4 | 0.6 | 8.7 | | 0.08 |
| EFFECT ON CAPACITY (PCU/MIN) OF MARGINAL CHANGES IN: | | | | | | | | | |
| | MARGINAL | ENTRY | FLARE | INSCRIBED | ENTRY | | | | |
| | CHANGE: | WIDTH | LENGTH | CIRC DIAM | ANGLE | | | | |
| | | (.1M) | (M) | (M) | (10 DEGS) | | | | |
| | ARM A | 0.524 | 0.000 | 0.011 | -1.225 | | | | |
| | ARM B | 0.515 | 0.000 | 0.031 | -1.012 | | | | |
| | ARM C | 0.168 | 0.113 | 0.127 | -0.702 | | | | |

| TIME | DEMAND (VEH/MIN) | CAPACITY (VEH/MIN) | DEMAND/ CAPACITY (RFC) | PEDESTRIAN FLOW (PEDS/MIN) | START QUEUE (VEHS) | END QUEUE (VEHS) | DELAY (VEH.MIN/ TIME SEGMENT) | GEOMETRIC DELAY (VEH.MIN/ TIME SEGMENT) | AVERAGE DELAY PER ARRIVING VEHICLE (MIN) |
|--|---------------------|-----------------------|------------------------------|----------------------------------|--------------------------|------------------------|-------------------------------------|---|--|
| 17.30-17.45 | | | | | | | | | |
| ARM A | 12.45 | 37.45 | 0.332 | | 0.5 | 0.5 | 7.4 | | 0.04 |
| ARM B | 30.11 | 31.78 | 0.947 | | 12.0 | 13.9 | 196.4 | | 0.49 |
| ARM C | 7.39 | 19.43 | 0.380 | | 0.6 | 0.6 | 9.1 | | 0.08 |
| EFFECT ON CAPACITY (PCU/MIN) OF MARGINAL CHANGES IN: | | | | | | | | | |
| | MARGINAL | ENTRY | FLARE | INSCRIBED | ENTRY | | | | |
| | CHANGE: | WIDTH | LENGTH | CIRC DIAM | ANGLE | | | | |
| | | (.1M) | (M) | (M) | (10 DEGS) | | | | |
| | ARM A | 0.524 | 0.000 | 0.011 | -1.225 | | | | |
| | ARM B | 0.515 | 0.000 | 0.031 | -1.012 | | | | |
| | ARM C | 0.167 | 0.112 | 0.129 | -0.692 | | | | |

| TIME | DEMAND (VEH/MIN) | CAPACITY (VEH/MIN) | DEMAND/ CAPACITY (RFC) | PEDESTRIAN FLOW (PEDS/MIN) | START QUEUE (VEHS) | END QUEUE (VEHS) | DELAY (VEH.MIN/ TIME SEGMENT) | GEOMETRIC DELAY (VEH.MIN/ TIME SEGMENT) | AVERAGE DELAY PER ARRIVING VEHICLE (MIN) |
|--|---------------------|-----------------------|------------------------------|----------------------------------|--------------------------|------------------------|-------------------------------------|---|--|
| 17.45-18.00 | | | | | | | | | |
| ARM A | 10.16 | 37.70 | 0.270 | | 0.5 | 0.4 | 5.6 | | 0.04 |
| ARM B | 24.58 | 32.50 | 0.756 | | 13.9 | 3.2 | 60.7 | | 0.15 |
| ARM C | 6.03 | 21.95 | 0.275 | | 0.6 | 0.4 | 5.8 | | 0.06 |
| EFFECT ON CAPACITY (PCU/MIN) OF MARGINAL CHANGES IN: | | | | | | | | | |
| | MARGINAL | ENTRY | FLARE | INSCRIBED | ENTRY | | | | |
| | CHANGE: | WIDTH | LENGTH | CIRC DIAM | ANGLE | | | | |
| | | (.1M) | (M) | (M) | (10 DEGS) | | | | |
| | ARM A | 0.526 | 0.000 | 0.009 | -1.233 | | | | |
| | ARM B | 0.522 | 0.000 | 0.026 | -1.035 | | | | |
| | ARM C | 0.177 | 0.119 | 0.109 | -0.783 | | | | |

| TIME | DEMAND (VEH/MIN) | CAPACITY (VEH/MIN) | DEMAND/ CAPACITY (RFC) | PEDESTRIAN FLOW (PEDS/MIN) | START QUEUE (VEHS) | END QUEUE (VEHS) | DELAY (VEH.MIN/ TIME SEGMENT) | GEOMETRIC DELAY (VEH.MIN/ TIME SEGMENT) | AVERAGE DELAY PER ARRIVING VEHICLE (MIN) |
|--|---------------------|-----------------------|------------------------------|----------------------------------|--------------------------|------------------------|-------------------------------------|---|--|
| 18.00-18.15 | | | | | | | | | |
| ARM A | 8.51 | 37.88 | 0.225 | | 0.4 | 0.3 | 4.4 | | 0.03 |
| ARM B | 20.59 | 33.02 | 0.623 | | 3.2 | 1.7 | 26.2 | | 0.08 |
| ARM C | 5.05 | 24.43 | 0.207 | | 0.4 | 0.3 | 4.0 | | 0.05 |
| EFFECT ON CAPACITY (PCU/MIN) OF MARGINAL CHANGES IN: | | | | | | | | | |
| | MARGINAL | ENTRY | FLARE | INSCRIBED | ENTRY | | | | |
| | CHANGE: | WIDTH | LENGTH | CIRC DIAM | ANGLE | | | | |
| | | (.1M) | (M) | (M) | (10 DEGS) | | | | |
| | ARM A | 0.528 | 0.000 | 0.007 | -1.239 | | | | |
| | ARM B | 0.526 | 0.000 | 0.022 | -1.051 | | | | |
| | ARM C | 0.186 | 0.125 | 0.089 | -0.871 | | | | |

QUEUE AT ARM A

| TIME SEGMENT ENDING | NO. OF VEHICLES IN QUEUE |
|------------------------|--------------------------------|
| 17.00 | 0.3 |
| 17.15 | 0.4 |
| 17.30 | 0.5 |
| 17.45 | 0.5 |
| 18.00 | 0.4 |
| 18.15 | 0.3 |

QUEUE AT ARM B

| TIME SEGMENT ENDING | NO. OF VEHICLES IN QUEUE | |
|------------------------|--------------------------------|-------|
| 17.00 | 1.6 | ** |
| 17.15 | 3.0 | *** |
| 17.30 | 12.0 | ***** |
| 17.45 | 13.9 | ***** |
| 18.00 | 3.2 | *** |
| 18.15 | 1.7 | ** |

QUEUE AT ARM C

| TIME SEGMENT ENDING | NO. OF VEHICLES IN QUEUE | |
|------------------------|--------------------------------|---|
| 17.00 | 0.3 | |
| 17.15 | 0.4 | |
| 17.30 | 0.6 | * |
| 17.45 | 0.6 | * |
| 18.00 | 0.4 | |
| 18.15 | 0.3 | |

 QUEUEING DELAY INFORMATION OVER WHOLE PERIOD

| I | ARM | I | TOTAL DEMAND | | * QUEUEING * | | * INCLUSIVE QUEUEING * | |
|---|-----|---|--------------|---------|--------------|-----------|------------------------|-----------|
| | | | I | I | I | I | I | I |
| | | | (VEH) | (VEH/H) | (MIN) | (MIN/VEH) | (MIN) | (MIN/VEH) |
| I | A | I | 933.8 | 622.5 | 34.6 | 0.04 | 34.6 | 0.04 |
| I | B | I | 2258.4 | 1505.6 | 488.7 | 0.22 | 488.7 | 0.22 |
| I | C | I | 554.0 | 369.3 | 36.8 | 0.07 | 36.8 | 0.07 |
| I | ALL | I | 3746.1 | 2497.4 | 560.0 | 0.15 | 560.1 | 0.15 |

* DELAY IS THAT OCCURRING ONLY WITHIN THE TIME PERIOD.
 * INCLUSIVE DELAY INCLUDES DELAY SUFFERED BY VEHICLES WHICH ARE STILL QUEUEING AFTER THE END OF THE TIME PERIOD.
 * THESE WILL ONLY BE SIGNIFICANTLY DIFFERENT IF THERE IS A LARGE QUEUE REMAINING AT THE END OF THE TIME PERIOD.

END OF JOB

===== end of file =====

ARCADY 6

ASSESSMENT OF ROUNDABOUT CAPACITY AND DELAY

Analysis Program: Release 3.0 (JUNE 2005)

(c) Copyright TRL Limited, 2004

Adapted from ARCADY/3 which is Crown Copyright
by permission of the controller of HMSO

For sales and distribution information,
program advice and maintenance, contact:

TRL Limited Tel: +44 (0) 1344 770018
Crowthorne House Fax: +44 (0) 1344 770864
Nine Mile Ride Email: softwarebureau@trl.co.uk
Wokingham, Berks. Web: www.trlsoftware.co.uk
RG40 3GA,UK

THE USER OF THIS COMPUTER PROGRAM FOR THE SOLUTION OF AN ENGINEERING PROBLEM IS
IN NO WAY RELIEVED OF THEIR RESPONSIBILITY FOR THE CORRECTNESS OF THE SOLUTION

Run with file:-

"j:\120000\120669-00\4 Internal Project Data\4-04 Calculations\4-04-06 Junction Analysis\Arcady\2028 Base + Gen\
AM\B430 Roundabout - 2028 Base + Gen AM.vai"
(drive-on-the-left) at 09:40:48 on Friday, 3 August 2007

FILE PROPERTIES

RUN TITLE: B430 Roundabout - Junction 10 - 2028 Base + Gen AM
LOCATION: Oxfordshire
DATE: 03/08/2007
CLIENT: North Oxfordshire Consortium
ENUMERATOR: Paul Dickens
JOB NUMBER: 120669
STATUS:
DESCRIPTION:

INPUT DATA

ARM A - A43
ARM B - M40 Slips
ARM C - B430

GEOMETRIC DATA

| I | ARM | I | V (M) | I | E (M) | I | L (M) | I | R (M) | I | D (M) | I | PHI (DEG) | I | SLOPE | I | INTERCEPT (PCU/MIN) | I |
|---|-------|---|--------|---|-------|---|-------|---|-------|---|-------|---|-----------|---|-------|---|---------------------|---|
| I | ARM A | I | 7.25 * | I | 7.25 | I | 0.00 | I | 30.00 | I | 72.00 | I | 17.5 | I | 0.608 | I | 38.797 | I |
| I | ARM B | I | 6.00 | I | 6.50 | I | 0.00 | I | 50.00 | I | 72.00 | I | 13.0 | I | 0.587 | I | 35.724 | I |
| I | ARM C | I | 3.50 | I | 9.00 | I | 38.00 | I | 22.50 | I | 72.00 | I | 40.0 | I | 0.558 | I | 35.585 | I |

V = approach half-width L = effective flare length D = inscribed circle diameter
E = entry width R = entry radius PHI = entry angle

WARNING ARM C: Effective flare length is outside normal range.
Treat capacities with increasing caution.

WARNING ARM A - INPUT VALUE OF V (7.30) OUTSIDE ACCEPTABLE RANGE -
HAS BEEN RESET AS INDICATED ABOVE (*). (AG17 REF. 6.3.1).

TRAFFIC DEMAND DATA

(Only sets included in the current run are shown)

| ARM | FLOW SCALE (%) |
|-----|----------------|
| A | 100 |
| B | 100 |
| C | 100 |

TIME PERIOD BEGINS 07.45 AND ENDS 09.15

LENGTH OF TIME PERIOD - 90 MINUTES.
 LENGTH OF TIME SEGMENT - 15 MINUTES.

DEMAND FLOW PROFILES ARE SYNTHESISED FROM TURNING COUNT DATA

DEMAND SET TITLE: B430 Roundabout - Junction 10 - 2028 Base + Gen AM

| ARM | NUMBER OF MINUTES FROM START WHEN FLOW STARTS TO RISE | TOP OF PEAK IS REACHED | FLOW STOPS IF FALLING | RATE OF FLOW (VEH/MIN) BEFORE PEAK | AT TOP OF PEAK | AFTER PEAK |
|-------|---|------------------------|-----------------------|------------------------------------|----------------|------------|
| ARM A | 15.00 | 45.00 | 75.00 | 18.24 | 27.36 | 18.24 |
| ARM B | 15.00 | 45.00 | 75.00 | 16.66 | 24.99 | 16.66 |
| ARM C | 15.00 | 45.00 | 75.00 | 8.69 | 13.03 | 8.69 |

DEMAND SET TITLE: B430 Roundabout - Junction 10 - 2028 Base + Gen AM

| TIME | TURNING PROPORTIONS | | | TURNING COUNTS (VEH/HR) | | | (PERCENTAGE OF H.V.S) | | | |
|---------------|---------------------|-------|-------|-------------------------|--------|-------|-----------------------|--------|--------|--------|
| | FROM/TO | ARM A | ARM B | ARM C | ARM A | ARM B | ARM C | ARM A | ARM B | ARM C |
| 07.45 - 09.15 | ARM A | 0.000 | 0.294 | 0.706 | 0.0 | 429.0 | 1030.0 | (0.0) | (0.0) | (0.0) |
| | ARM B | 0.953 | 0.000 | 0.047 | 1270.0 | 0.0 | 63.0 | (0.0) | (0.0) | (0.0) |
| | ARM C | 0.584 | 0.416 | 0.000 | 406.0 | 289.0 | 0.0 | (0.0) | (0.0) | (0.0) |

QUEUE AND DELAY INFORMATION FOR EACH 15 MIN TIME SEGMENT

| TIME | DEMAND (VEH/MIN) | CAPACITY (VEH/MIN) | DEMAND/CAPACITY (RFC) | PEDESTRIAN FLOW (PEDS/MIN) | START QUEUE (VEHS) | END QUEUE (VEHS) | DELAY (VEH.MIN/TIME SEGMENT) | GEOMETRIC DELAY (VEH.MIN/TIME SEGMENT) | AVERAGE DELAY PER ARRIVING VEHICLE (MIN) |
|--|------------------|--------------------|-----------------------|----------------------------|-----------------------|------------------|------------------------------|--|--|
| 07.45-08.00 | | | | | | | | | |
| ARM A | 18.24 | 36.61 | 0.498 | | 0.0 | 1.0 | 14.4 | | 0.05 |
| ARM B | 16.66 | 28.20 | 0.591 | | 0.0 | 1.4 | 20.4 | | 0.09 |
| ARM C | 8.69 | 26.78 | 0.324 | | 0.0 | 0.5 | 7.0 | | 0.06 |
| EFFECT ON CAPACITY (PCU/MIN) OF MARGINAL CHANGES IN: | | | | | | | | | |
| | MARGINAL CHANGE: | ENTRY WIDTH (.1M) | FLARE LENGTH (M) | INSCRIBED CIRC DIAM (M) | ENTRY ANGLE (10 DEGS) | | | | |
| | ARM A | 0.517 | 0.000 | 0.017 | -1.197 | | | | |
| | ARM B | 0.484 | 0.000 | 0.060 | -0.898 | | | | |
| | ARM C | 0.195 | 0.131 | 0.070 | -0.956 | | | | |

| TIME | DEMAND (VEH/MIN) | CAPACITY (VEH/MIN) | DEMAND/ CAPACITY (RFC) | PEDESTRIAN FLOW (PEDS/MIN) | START QUEUE (VEHS) | END QUEUE (VEHS) | DELAY (VEH.MIN/ TIME SEGMENT) | GEOMETRIC DELAY (VEH.MIN/ TIME SEGMENT) | AVERAGE DELAY PER ARRIVING VEHICLE (MIN) |
|--|---------------------|-----------------------|------------------------------|----------------------------------|--------------------------|------------------------|-------------------------------------|---|--|
| 08.00-08.15 | | | | | | | | | |
| ARM A | 21.78 | 36.18 | 0.602 | | 1.0 | 1.5 | 21.8 | | 0.07 |
| ARM B | 19.90 | 26.72 | 0.745 | | 1.4 | 2.8 | 39.4 | | 0.14 |
| ARM C | 10.37 | 25.06 | 0.414 | | 0.5 | 0.7 | 10.3 | | 0.07 |
| EFFECT ON CAPACITY (PCU/MIN) OF MARGINAL CHANGES IN: | | | | | | | | | |
| | MARGINAL | ENTRY | FLARE | INSCRIBED | ENTRY | | | | |
| | CHANGE: | WIDTH | LENGTH | CIRC DIAM | ANGLE | | | | |
| | | (.1M) | (M) | (M) | (10 DEGS) | | | | |
| | ARM A | 0.514 | 0.000 | 0.021 | -1.183 | | | | |
| | ARM B | 0.471 | 0.000 | 0.072 | -0.850 | | | | |
| | ARM C | 0.189 | 0.127 | 0.084 | -0.894 | | | | |

| TIME | DEMAND (VEH/MIN) | CAPACITY (VEH/MIN) | DEMAND/ CAPACITY (RFC) | PEDESTRIAN FLOW (PEDS/MIN) | START QUEUE (VEHS) | END QUEUE (VEHS) | DELAY (VEH.MIN/ TIME SEGMENT) | GEOMETRIC DELAY (VEH.MIN/ TIME SEGMENT) | AVERAGE DELAY PER ARRIVING VEHICLE (MIN) |
|--|---------------------|-----------------------|------------------------------|----------------------------------|--------------------------|------------------------|-------------------------------------|---|--|
| 08.15-08.30 | | | | | | | | | |
| ARM A | 26.67 | 35.59 | 0.749 | | 1.5 | 2.9 | 41.1 | | 0.11 |
| ARM B | 24.37 | 24.72 | 0.986 | | 2.8 | 16.5 | 172.6 | | 0.58 |
| ARM C | 12.71 | 23.12 | 0.549 | | 0.7 | 1.2 | 17.4 | | 0.10 |
| EFFECT ON CAPACITY (PCU/MIN) OF MARGINAL CHANGES IN: | | | | | | | | | |
| | MARGINAL | ENTRY | FLARE | INSCRIBED | ENTRY | | | | |
| | CHANGE: | WIDTH | LENGTH | CIRC DIAM | ANGLE | | | | |
| | | (.1M) | (M) | (M) | (10 DEGS) | | | | |
| | ARM A | 0.509 | 0.000 | 0.026 | -1.164 | | | | |
| | ARM B | 0.454 | 0.000 | 0.088 | -0.786 | | | | |
| | ARM C | 0.181 | 0.122 | 0.099 | -0.825 | | | | |

| TIME | DEMAND (VEH/MIN) | CAPACITY (VEH/MIN) | DEMAND/ CAPACITY (RFC) | PEDESTRIAN FLOW (PEDS/MIN) | START QUEUE (VEHS) | END QUEUE (VEHS) | DELAY (VEH.MIN/ TIME SEGMENT) | GEOMETRIC DELAY (VEH.MIN/ TIME SEGMENT) | AVERAGE DELAY PER ARRIVING VEHICLE (MIN) |
|--|---------------------|-----------------------|------------------------------|----------------------------------|--------------------------|------------------------|-------------------------------------|---|--|
| 08.30-08.45 | | | | | | | | | |
| ARM A | 26.67 | 35.58 | 0.750 | | 2.9 | 2.9 | 44.0 | | 0.11 |
| ARM B | 24.37 | 24.68 | 0.987 | | 16.5 | 22.3 | 294.1 | | 0.93 |
| ARM C | 12.71 | 22.85 | 0.556 | | 1.2 | 1.2 | 18.4 | | 0.10 |
| EFFECT ON CAPACITY (PCU/MIN) OF MARGINAL CHANGES IN: | | | | | | | | | |
| | MARGINAL | ENTRY | FLARE | INSCRIBED | ENTRY | | | | |
| | CHANGE: | WIDTH | LENGTH | CIRC DIAM | ANGLE | | | | |
| | | (.1M) | (M) | (M) | (10 DEGS) | | | | |
| | ARM A | 0.509 | 0.000 | 0.026 | -1.163 | | | | |
| | ARM B | 0.454 | 0.000 | 0.088 | -0.785 | | | | |
| | ARM C | 0.180 | 0.121 | 0.102 | -0.815 | | | | |

| TIME | DEMAND (VEH/MIN) | CAPACITY (VEH/MIN) | DEMAND/ CAPACITY (RFC) | PEDESTRIAN FLOW (PEDS/MIN) | START QUEUE (VEHS) | END QUEUE (VEHS) | DELAY (VEH.MIN/ TIME SEGMENT) | GEOMETRIC DELAY (VEH.MIN/ TIME SEGMENT) | AVERAGE DELAY PER ARRIVING VEHICLE (MIN) |
|--|---------------------|-----------------------|------------------------------|----------------------------------|--------------------------|------------------------|-------------------------------------|---|--|
| 08.45-09.00 | | | | | | | | | |
| ARM A | 21.78 | 36.17 | 0.602 | | 2.9 | 1.5 | 23.8 | | 0.07 |
| ARM B | 19.90 | 26.67 | 0.746 | | 22.3 | 3.1 | 81.3 | | 0.22 |
| ARM C | 10.37 | 24.33 | 0.426 | | 1.2 | 0.7 | 11.5 | | 0.07 |
| EFFECT ON CAPACITY (PCU/MIN) OF MARGINAL CHANGES IN: | | | | | | | | | |
| | MARGINAL | ENTRY | FLARE | INSCRIBED | ENTRY | | | | |
| | CHANGE: | WIDTH | LENGTH | CIRC DIAM | ANGLE | | | | |
| | | (.1M) | (M) | (M) | (10 DEGS) | | | | |
| | ARM A | 0.514 | 0.000 | 0.021 | -1.183 | | | | |
| | ARM B | 0.471 | 0.000 | 0.072 | -0.849 | | | | |
| | ARM C | 0.186 | 0.125 | 0.090 | -0.868 | | | | |

| I | TIME | DEMAND (VEH/MIN) | CAPACITY (VEH/MIN) | DEMAND/ CAPACITY (RFC) | PEDESTRIAN FLOW (PEDS/MIN) | START QUEUE (VEHS) | END QUEUE (VEHS) | DELAY (VEH.MIN/ TIME SEGMENT) | GEOMETRIC DELAY (VEH.MIN/ TIME SEGMENT) | AVERAGE DELAY PER ARRIVING VEHICLE (MIN) | I | |
|---|-------------|--|-----------------------|------------------------------|----------------------------------|--------------------------|------------------------|-------------------------------------|---|--|---|---|
| I | 09.00-09.15 | | | | | | | | | | I | |
| I | ARM A | 18.24 | 36.60 | 0.498 | | 1.5 | 1.0 | 15.4 | | 0.05 | I | |
| I | ARM B | 16.66 | 28.16 | 0.592 | | 3.1 | 1.5 | 23.0 | | 0.09 | I | |
| I | ARM C | 8.69 | 26.68 | 0.326 | | 0.7 | 0.5 | 7.4 | | 0.06 | I | |
| I | | EFFECT ON CAPACITY (PCU/MIN) OF MARGINAL CHANGES IN: | | | | | | | | | | I |
| I | | | ENTRY | FLARE | INSCRIBED | ENTRY | | | | | I | |
| I | | MARGINAL | WIDTH | LENGTH | CIRC DIAM | ANGLE | | | | | I | |
| I | | CHANGE: | (.1M) | (M) | (M) | (10 DEGS) | | | | | I | |
| I | | ARM A | 0.517 | 0.000 | 0.018 | -1.197 | | | | | I | |
| I | | ARM B | 0.484 | 0.000 | 0.060 | -0.896 | | | | | I | |
| I | | ARM C | 0.195 | 0.131 | 0.071 | -0.952 | | | | | I | |

QUEUE AT ARM A

| TIME SEGMENT ENDING | NO. OF VEHICLES IN QUEUE | |
|------------------------|--------------------------------|-----|
| 08.00 | 1.0 | * |
| 08.15 | 1.5 | * |
| 08.30 | 2.9 | *** |
| 08.45 | 2.9 | *** |
| 09.00 | 1.5 | ** |
| 09.15 | 1.0 | * |

QUEUE AT ARM B

| TIME SEGMENT ENDING | NO. OF VEHICLES IN QUEUE | |
|------------------------|--------------------------------|-------|
| 08.00 | 1.4 | * |
| 08.15 | 2.8 | *** |
| 08.30 | 16.5 | ***** |
| 08.45 | 22.3 | ***** |
| 09.00 | 3.1 | *** |
| 09.15 | 1.5 | * |

QUEUE AT ARM C

| TIME SEGMENT ENDING | NO. OF VEHICLES IN QUEUE | |
|------------------------|--------------------------------|---|
| 08.00 | 0.5 | |
| 08.15 | 0.7 | * |
| 08.30 | 1.2 | * |
| 08.45 | 1.2 | * |
| 09.00 | 0.7 | * |
| 09.15 | 0.5 | |

 QUEUEING DELAY INFORMATION OVER WHOLE PERIOD

| I | ARM | I | TOTAL DEMAND | I | * QUEUEING * | I | * INCLUSIVE QUEUEING * | I | |
|---|-----|-------|--------------|---|--------------|---|------------------------|---|------|
| I | I | I | I | I | * DELAY * | I | * DELAY * | I | |
| I | I | I | I | I | (MIN) | I | (MIN) | I | |
| I | I | (VEH) | (VEH/H) | I | (MIN/VEH) | I | (MIN/VEH) | I | |
| I | A | I | 2000.6 | I | 1333.7 | I | 160.4 | I | 0.08 |
| I | B | I | 1827.8 | I | 1218.5 | I | 630.9 | I | 0.35 |
| I | C | I | 953.0 | I | 635.3 | I | 72.1 | I | 0.08 |
| I | ALL | I | 4781.4 | I | 3187.6 | I | 863.4 | I | 0.18 |

* DELAY IS THAT OCCURRING ONLY WITHIN THE TIME PERIOD.
 * INCLUSIVE DELAY INCLUDES DELAY SUFFERED BY VEHICLES WHICH ARE STILL QUEUEING AFTER THE END OF THE TIME PERIOD.
 * THESE WILL ONLY BE SIGNIFICANTLY DIFFERENT IF THERE IS A LARGE QUEUE REMAINING AT THE END OF THE TIME PERIOD.

END OF JOB

===== end of file =====

ARCADY 6

ASSESSMENT OF ROUNDABOUT CAPACITY AND DELAY

Analysis Program: Release 3.0 (JUNE 2005)

(c) Copyright TRL Limited, 2004

Adapted from ARCADY/3 which is Crown Copyright
by permission of the controller of HMSO

For sales and distribution information,
program advice and maintenance, contact:

TRL Limited Tel: +44 (0) 1344 770018
Crowthorne House Fax: +44 (0) 1344 770864
Nine Mile Ride Email: softwarebureau@trl.co.uk
Wokingham, Berks. Web: www.trlsoftware.co.uk
RG40 3GA,UK

THE USER OF THIS COMPUTER PROGRAM FOR THE SOLUTION OF AN ENGINEERING PROBLEM IS
IN NO WAY RELIEVED OF THEIR RESPONSIBILITY FOR THE CORRECTNESS OF THE SOLUTION

Run with file:-

"j:\120000\120669-00\4 Internal Project Data\4-04 Calculations\4-04-06 Junction Analysis\Arcady\2028 Base + Gen\
PM\B430 Roundabout - 2028 Base + Gen PM.vai"
(drive-on-the-left) at 09:42:21 on Friday, 3 August 2007

FILE PROPERTIES

RUN TITLE: B430 Roundabout - Junction 10 - 2028 Base + Gen PM
LOCATION: Oxfordshire
DATE: 03/08/2007
CLIENT: North Oxfordshire Consortium
ENUMERATOR: Paul Dickens
JOB NUMBER: 120669
STATUS:
DESCRIPTION:

INPUT DATA

ARM A - A43
ARM B - M40 Slips
ARM C - B430

GEOMETRIC DATA

| I | ARM | I | V (M) | I | E (M) | I | L (M) | I | R (M) | I | D (M) | I | PHI (DEG) | I | SLOPE | I | INTERCEPT (PCU/MIN) | I |
|---|-------|---|--------|---|-------|---|-------|---|-------|---|-------|---|-----------|---|-------|---|---------------------|---|
| I | ARM A | I | 7.25 * | I | 7.25 | I | 0.00 | I | 30.00 | I | 72.00 | I | 17.5 | I | 0.608 | I | 38.797 | I |
| I | ARM B | I | 6.00 | I | 6.50 | I | 0.00 | I | 50.00 | I | 72.00 | I | 13.0 | I | 0.587 | I | 35.724 | I |
| I | ARM C | I | 3.50 | I | 9.00 | I | 38.00 | I | 22.50 | I | 72.00 | I | 40.0 | I | 0.558 | I | 35.585 | I |

V = approach half-width L = effective flare length D = inscribed circle diameter
E = entry width R = entry radius PHI = entry angle

WARNING ARM C: Effective flare length is outside normal range.
Treat capacities with increasing caution.

WARNING ARM A - INPUT VALUE OF V (7.30) OUTSIDE ACCEPTABLE RANGE -
HAS BEEN RESET AS INDICATED ABOVE (*). (AG17 REF. 6.3.1).

TRAFFIC DEMAND DATA

(Only sets included in the current run are shown)

| ARM | FLOW SCALE (%) |
|-----|----------------|
| A | 100 |
| B | 100 |
| C | 100 |

TIME PERIOD BEGINS 16.45 AND ENDS 18.15

LENGTH OF TIME PERIOD - 90 MINUTES.
 LENGTH OF TIME SEGMENT - 15 MINUTES.

DEMAND FLOW PROFILES ARE SYNTHESISED FROM TURNING COUNT DATA

DEMAND SET TITLE: B430 Roundabout - Junction 10 - 2028 Base + Gen PM

| ARM | NUMBER OF MINUTES FROM START WHEN FLOW STARTS TO RISE | TOP OF PEAK IS REACHED | FLOW STOPS FALLING | RATE OF FLOW (VEH/MIN) BEFORE PEAK | AT TOP OF PEAK | AFTER PEAK |
|-------|---|------------------------|--------------------|------------------------------------|----------------|------------|
| ARM A | 15.00 | 45.00 | 75.00 | 11.15 | 16.72 | 11.15 |
| ARM B | 15.00 | 45.00 | 75.00 | 20.90 | 31.35 | 20.90 |
| ARM C | 15.00 | 45.00 | 75.00 | 9.39 | 14.08 | 9.39 |

DEMAND SET TITLE: B430 Roundabout - Junction 10 - 2028 Base + Gen PM

| TIME | TURNING PROPORTIONS | | | TURNING COUNTS (VEH/HR) | | | (PERCENTAGE OF H.V.S) | | | |
|---------------|---------------------|-------|-------|-------------------------|--------|-------|-----------------------|--------|--------|--------|
| | FROM/TO | ARM A | ARM B | ARM C | ARM A | ARM B | ARM C | ARM A | ARM B | ARM C |
| 16.45 - 18.15 | ARM A | 0.001 | 0.351 | 0.648 | 1.0 | 313.0 | 578.0 | (0.0) | (0.0) | (0.0) |
| | ARM B | 0.952 | 0.000 | 0.048 | 1591.0 | 0.0 | 81.0 | (0.0) | (0.0) | (0.0) |
| | ARM C | 0.722 | 0.278 | 0.000 | 542.0 | 209.0 | 0.0 | (0.0) | (0.0) | (0.0) |

QUEUE AND DELAY INFORMATION FOR EACH 15 MIN TIME SEGMENT

| TIME | DEMAND (VEH/MIN) | CAPACITY (VEH/MIN) | DEMAND/CAPACITY (RFC) | PEDESTRIAN FLOW (PEDS/MIN) | START QUEUE (VEHS) | END QUEUE (VEHS) | DELAY (VEH.MIN/TIME SEGMENT) | GEOMETRIC DELAY (VEH.MIN/TIME SEGMENT) | AVERAGE DELAY PER ARRIVING VEHICLE (MIN) |
|--|------------------|--------------------|-----------------------|----------------------------|-----------------------|------------------|------------------------------|--|--|
| 16.45-17.00 | | | | | | | | | |
| ARM A | 11.15 | 37.22 | 0.300 | | 0.0 | 0.4 | 6.3 | | 0.04 |
| ARM B | 20.90 | 31.49 | 0.664 | | 0.0 | 1.9 | 27.6 | | 0.09 |
| ARM C | 9.39 | 24.56 | 0.382 | | 0.0 | 0.6 | 9.0 | | 0.07 |
| EFFECT ON CAPACITY (PCU/MIN) OF MARGINAL CHANGES IN: | | | | | | | | | |
| | MARGINAL CHANGE: | ENTRY WIDTH (.1M) | FLARE LENGTH (M) | INSCRIBED CIRC DIAM (M) | ENTRY ANGLE (10 DEGS) | | | | |
| | ARM A | 0.522 | 0.000 | 0.013 | -1.217 | | | | |
| | ARM B | 0.513 | 0.000 | 0.034 | -1.002 | | | | |
| | ARM C | 0.187 | 0.125 | 0.088 | -0.876 | | | | |

| TIME | DEMAND (VEH/MIN) | CAPACITY (VEH/MIN) | DEMAND/ CAPACITY (RFC) | PEDESTRIAN FLOW (PEDS/MIN) | START QUEUE (VEHS) | END QUEUE (VEHS) | DELAY (VEH.MIN/ TIME SEGMENT) | GEOMETRIC DELAY (VEH.MIN/ TIME SEGMENT) | AVERAGE DELAY PER ARRIVING VEHICLE (MIN) |
|--|---------------------|-----------------------|------------------------------|----------------------------------|--------------------------|------------------------|-------------------------------------|---|--|
| 17.00-17.15 | | | | | | | | | |
| ARM A | 13.31 | 36.90 | 0.361 | | 0.4 | 0.6 | 8.3 | | 0.04 |
| ARM B | 24.96 | 30.66 | 0.814 | | 1.9 | 4.1 | 56.6 | | 0.17 |
| ARM C | 11.21 | 22.41 | 0.500 | | 0.6 | 1.0 | 14.4 | | 0.09 |
| EFFECT ON CAPACITY (PCU/MIN) OF MARGINAL CHANGES IN: | | | | | | | | | |
| | MARGINAL | ENTRY | FLARE | INSCRIBED | ENTRY | | | | |
| | CHANGE: | WIDTH | LENGTH | CIRC DIAM | ANGLE | | | | |
| | | (.1M) | (M) | (M) | (10 DEGS) | | | | |
| | ARM A | 0.520 | 0.000 | 0.015 | -1.207 | | | | |
| | ARM B | 0.506 | 0.000 | 0.040 | -0.976 | | | | |
| | ARM C | 0.179 | 0.120 | 0.105 | -0.799 | | | | |

| TIME | DEMAND (VEH/MIN) | CAPACITY (VEH/MIN) | DEMAND/ CAPACITY (RFC) | PEDESTRIAN FLOW (PEDS/MIN) | START QUEUE (VEHS) | END QUEUE (VEHS) | DELAY (VEH.MIN/ TIME SEGMENT) | GEOMETRIC DELAY (VEH.MIN/ TIME SEGMENT) | AVERAGE DELAY PER ARRIVING VEHICLE (MIN) |
|--|---------------------|-----------------------|------------------------------|----------------------------------|--------------------------|------------------------|-------------------------------------|---|--|
| 17.15-17.30 | | | | | | | | | |
| ARM A | 16.31 | 36.49 | 0.447 | | 0.6 | 0.8 | 11.8 | | 0.05 |
| ARM B | 30.57 | 29.52 | 1.035 | | 4.1 | 30.8 | 289.0 | | 0.77 |
| ARM C | 13.73 | 20.29 | 0.676 | | 1.0 | 2.0 | 28.6 | | 0.15 |
| EFFECT ON CAPACITY (PCU/MIN) OF MARGINAL CHANGES IN: | | | | | | | | | |
| | MARGINAL | ENTRY | FLARE | INSCRIBED | ENTRY | | | | |
| | CHANGE: | WIDTH | LENGTH | CIRC DIAM | ANGLE | | | | |
| | | (.1M) | (M) | (M) | (10 DEGS) | | | | |
| | ARM A | 0.516 | 0.000 | 0.018 | -1.193 | | | | |
| | ARM B | 0.496 | 0.000 | 0.049 | -0.940 | | | | |
| | ARM C | 0.171 | 0.114 | 0.122 | -0.724 | | | | |

| TIME | DEMAND (VEH/MIN) | CAPACITY (VEH/MIN) | DEMAND/ CAPACITY (RFC) | PEDESTRIAN FLOW (PEDS/MIN) | START QUEUE (VEHS) | END QUEUE (VEHS) | DELAY (VEH.MIN/ TIME SEGMENT) | GEOMETRIC DELAY (VEH.MIN/ TIME SEGMENT) | AVERAGE DELAY PER ARRIVING VEHICLE (MIN) |
|--|---------------------|-----------------------|------------------------------|----------------------------------|--------------------------|------------------------|-------------------------------------|---|--|
| 17.30-17.45 | | | | | | | | | |
| ARM A | 16.31 | 36.47 | 0.447 | | 0.8 | 0.8 | 12.1 | | 0.05 |
| ARM B | 30.57 | 29.52 | 1.036 | | 30.8 | 49.8 | 607.2 | | 1.51 |
| ARM C | 13.73 | 20.03 | 0.686 | | 2.0 | 2.1 | 31.5 | | 0.16 |
| EFFECT ON CAPACITY (PCU/MIN) OF MARGINAL CHANGES IN: | | | | | | | | | |
| | MARGINAL | ENTRY | FLARE | INSCRIBED | ENTRY | | | | |
| | CHANGE: | WIDTH | LENGTH | CIRC DIAM | ANGLE | | | | |
| | | (.1M) | (M) | (M) | (10 DEGS) | | | | |
| | ARM A | 0.516 | 0.000 | 0.019 | -1.193 | | | | |
| | ARM B | 0.496 | 0.000 | 0.049 | -0.939 | | | | |
| | ARM C | 0.170 | 0.114 | 0.124 | -0.714 | | | | |

| TIME | DEMAND (VEH/MIN) | CAPACITY (VEH/MIN) | DEMAND/ CAPACITY (RFC) | PEDESTRIAN FLOW (PEDS/MIN) | START QUEUE (VEHS) | END QUEUE (VEHS) | DELAY (VEH.MIN/ TIME SEGMENT) | GEOMETRIC DELAY (VEH.MIN/ TIME SEGMENT) | AVERAGE DELAY PER ARRIVING VEHICLE (MIN) |
|--|---------------------|-----------------------|------------------------------|----------------------------------|--------------------------|------------------------|-------------------------------------|---|--|
| 17.45-18.00 | | | | | | | | | |
| ARM A | 13.31 | 36.89 | 0.361 | | 0.8 | 0.6 | 8.6 | | 0.04 |
| ARM B | 24.96 | 30.65 | 0.814 | | 49.8 | 4.9 | 274.1 | | 0.64 |
| ARM C | 11.21 | 20.74 | 0.540 | | 2.1 | 1.2 | 18.7 | | 0.11 |
| EFFECT ON CAPACITY (PCU/MIN) OF MARGINAL CHANGES IN: | | | | | | | | | |
| | MARGINAL | ENTRY | FLARE | INSCRIBED | ENTRY | | | | |
| | CHANGE: | WIDTH | LENGTH | CIRC DIAM | ANGLE | | | | |
| | | (.1M) | (M) | (M) | (10 DEGS) | | | | |
| | ARM A | 0.520 | 0.000 | 0.015 | -1.206 | | | | |
| | ARM B | 0.505 | 0.000 | 0.040 | -0.976 | | | | |
| | ARM C | 0.172 | 0.116 | 0.118 | -0.740 | | | | |

| TIME | DEMAND (VEH/MIN) | CAPACITY (VEH/MIN) | DEMAND/ CAPACITY (RFC) | PEDESTRIAN FLOW (PEDS/MIN) | START QUEUE (VEHS) | END QUEUE (VEHS) | DELAY (VEH.MIN/ TIME SEGMENT) | GEOMETRIC DELAY (VEH.MIN/ TIME SEGMENT) | AVERAGE DELAY PER ARRIVING VEHICLE (MIN) |
|--|---------------------|-----------------------|------------------------------|----------------------------------|--------------------------|------------------------|-------------------------------------|---|--|
| 18.00-18.15 | | | | | | | | | |
| ARM A | 11.15 | 37.20 | 0.300 | | 0.6 | 0.4 | 6.5 | | 0.04 |
| ARM B | 20.90 | 31.48 | 0.664 | | 4.9 | 2.0 | 32.1 | | 0.10 |
| ARM C | 9.39 | 24.39 | 0.385 | | 1.2 | 0.6 | 9.7 | | 0.07 |
| EFFECT ON CAPACITY (PCU/MIN) OF MARGINAL CHANGES IN: | | | | | | | | | |
| | MARGINAL | ENTRY | FLARE | INSCRIBED | ENTRY | | | | |
| | CHANGE: | WIDTH | LENGTH | CIRC DIAM | ANGLE | | | | |
| | | (.1M) | (M) | (M) | (10 DEGS) | | | | |
| | ARM A | 0.522 | 0.000 | 0.013 | -1.216 | | | | |
| | ARM B | 0.513 | 0.000 | 0.034 | -1.002 | | | | |
| | ARM C | 0.186 | 0.125 | 0.089 | -0.870 | | | | |

QUEUE AT ARM A

| TIME SEGMENT ENDING | NO. OF VEHICLES IN QUEUE |
|------------------------|--------------------------------|
| 17.00 | 0.4 |
| 17.15 | 0.6 * |
| 17.30 | 0.8 * |
| 17.45 | 0.8 * |
| 18.00 | 0.6 * |
| 18.15 | 0.4 |

QUEUE AT ARM B

| TIME SEGMENT ENDING | NO. OF VEHICLES IN QUEUE |
|------------------------|--------------------------------|
| 17.00 | 1.9 ** |
| 17.15 | 4.1 **** |
| 17.30 | 30.8 ***** |
| 17.45 | 49.8 ***** |
| 18.00 | 4.9 ***** |
| 18.15 | 2.0 ** |

QUEUE AT ARM C

| TIME SEGMENT ENDING | NO. OF VEHICLES IN QUEUE |
|------------------------|--------------------------------|
| 17.00 | 0.6 * |
| 17.15 | 1.0 * |
| 17.30 | 2.0 ** |
| 17.45 | 2.1 ** |
| 18.00 | 1.2 * |
| 18.15 | 0.6 * |

 QUEUEING DELAY INFORMATION OVER WHOLE PERIOD

| I | ARM | I | TOTAL DEMAND | | I | * QUEUEING * | | I | * INCLUSIVE QUEUEING * | | I |
|---|-----|---|--------------|----------|---|--------------|-----------|---|------------------------|-----------|---|
| I | | I | | I | I | * DELAY * | | I | * DELAY * | | I |
| I | | I | (VEH) | (VEH/H) | I | (MIN) | (MIN/VEH) | I | (MIN) | (MIN/VEH) | I |
| I | A | I | 1223.1 | I 815.4 | I | 53.7 | I 0.04 | I | 53.7 | I 0.04 | I |
| I | B | I | 2292.7 | I 1528.4 | I | 1286.5 | I 0.56 | I | 1286.6 | I 0.56 | I |
| I | C | I | 1029.8 | I 686.5 | I | 111.8 | I 0.11 | I | 111.8 | I 0.11 | I |
| I | ALL | I | 4545.6 | I 3030.4 | I | 1452.0 | I 0.32 | I | 1452.1 | I 0.32 | I |

* DELAY IS THAT OCCURRING ONLY WITHIN THE TIME PERIOD.
 * INCLUSIVE DELAY INCLUDES DELAY SUFFERED BY VEHICLES WHICH ARE STILL QUEUEING AFTER THE END OF THE TIME PERIOD.
 * THESE WILL ONLY BE SIGNIFICANTLY DIFFERENT IF THERE IS A LARGE QUEUE REMAINING AT THE END OF THE TIME PERIOD.

END OF JOB

===== end of file =====

ARCADY 6

ASSESSMENT OF ROUNDABOUT CAPACITY AND DELAY

Analysis Program: Release 3.0 (JUNE 2005)

(c) Copyright TRL Limited, 2004

Adapted from ARCADY/3 which is Crown Copyright
by permission of the controller of HMSO

For sales and distribution information,
program advice and maintenance, contact:

TRL Limited Tel: +44 (0) 1344 770018
Crowthorne House Fax: +44 (0) 1344 770864
Nine Mile Ride Email: softwarebureau@trl.co.uk
Wokingham, Berks. Web: www.trlsoftware.co.uk
RG40 3GA,UK

THE USER OF THIS COMPUTER PROGRAM FOR THE SOLUTION OF AN ENGINEERING PROBLEM IS
IN NO WAY RELIEVED OF THEIR RESPONSIBILITY FOR THE CORRECTNESS OF THE SOLUTION

Run with file:-

"j:\120000\120669-00\4 Internal Project Data\4-04 Calculations\4-04-06 Junction Analysis\Arcady\
2028 Base + Gen Modified Roundabout\AM\B430 Roundabout - 2028 Base + Gen AM.vai"
(drive-on-the-left) at 13:34:37 on Tuesday, 14 August 2007

FILE PROPERTIES

RUN TITLE: B430 Roundabout - Junction 10 - 2028 Base + Gen AM Modified Roudabout
LOCATION: Oxfordshire
DATE: 03/08/2007
CLIENT: North Oxfordshire Consortium
ENUMERATOR: Paul Dickens
JOB NUMBER: 120669
STATUS:
DESCRIPTION:

INPUT DATA

ARM A - A43
ARM B - M40 Slips
ARM C - B430

GEOMETRIC DATA

| I | ARM | I | V (M) | I | E (M) | I | L (M) | I | R (M) | I | D (M) | I | PHI (DEG) | I | SLOPE | I | INTERCEPT (PCU/MIN) | I |
|---|-------|---|--------|---|-------|---|-------|---|-------|---|-------|---|-----------|---|-------|---|---------------------|---|
| I | ARM A | I | 7.25 * | I | 7.25 | I | 0.00 | I | 30.00 | I | 72.00 | I | 17.5 | I | 0.608 | I | 38.797 | I |
| I | ARM B | I | 6.00 | I | 9.00 | I | 18.00 | I | 50.00 | I | 72.00 | I | 12.5 | I | 0.662 | I | 43.799 | I |
| I | ARM C | I | 3.50 | I | 9.00 | I | 38.00 | I | 22.50 | I | 72.00 | I | 40.0 | I | 0.558 | I | 35.585 | I |

V = approach half-width L = effective flare length D = inscribed circle diameter
E = entry width R = entry radius PHI = entry angle

WARNING ARM C: Effective flare length is outside normal range.
Treat capacities with increasing caution.

WARNING ARM A - INPUT VALUE OF V (7.30) OUTSIDE ACCEPTABLE RANGE -
HAS BEEN RESET AS INDICATED ABOVE (*). (AG17 REF. 6.3.1).

TRAFFIC DEMAND DATA

(Only sets included in the current run are shown)

| ARM | FLOW SCALE (%) |
|-----|----------------|
| A | 100 |
| B | 100 |
| C | 100 |

TIME PERIOD BEGINS 07.45 AND ENDS 09.15

LENGTH OF TIME PERIOD - 90 MINUTES.
 LENGTH OF TIME SEGMENT - 15 MINUTES.

DEMAND FLOW PROFILES ARE SYNTHESISED FROM TURNING COUNT DATA

DEMAND SET TITLE: B430 Roundabout - Junction 10 - 2028 Base + Gen AM

| ARM | NUMBER OF MINUTES FROM START WHEN FLOW STARTS TO RISE | TOP OF PEAK IS REACHED | FLOW STOPS IF FALLING | RATE OF FLOW (VEH/MIN) BEFORE PEAK | AT TOP OF PEAK | AFTER PEAK |
|-------|---|------------------------|-----------------------|------------------------------------|----------------|------------|
| ARM A | 15.00 | 45.00 | 75.00 | 18.24 | 27.36 | 18.24 |
| ARM B | 15.00 | 45.00 | 75.00 | 16.66 | 24.99 | 16.66 |
| ARM C | 15.00 | 45.00 | 75.00 | 8.69 | 13.03 | 8.69 |

DEMAND SET TITLE: B430 Roundabout - Junction 10 - 2028 Base + Gen AM

| TIME | TURNING PROPORTIONS | | | TURNING COUNTS (VEH/HR) | | | (PERCENTAGE OF H.V.S) | | | |
|---------------|---------------------|-------|-------|-------------------------|--------|-------|-----------------------|--------|--------|--------|
| | FROM/TO | ARM A | ARM B | ARM C | ARM A | ARM B | ARM C | ARM A | ARM B | ARM C |
| 07.45 - 09.15 | ARM A | 0.000 | 0.294 | 0.706 | 0.0 | 429.0 | 1030.0 | (0.0) | (0.0) | (0.0) |
| | ARM B | 0.953 | 0.000 | 0.047 | 1270.0 | 0.0 | 63.0 | (0.0) | (0.0) | (0.0) |
| | ARM C | 0.584 | 0.416 | 0.000 | 406.0 | 289.0 | 0.0 | (0.0) | (0.0) | (0.0) |

QUEUE AND DELAY INFORMATION FOR EACH 15 MIN TIME SEGMENT

| TIME | DEMAND (VEH/MIN) | CAPACITY (VEH/MIN) | DEMAND/CAPACITY (RFC) | PEDESTRIAN FLOW (PEDS/MIN) | START QUEUE (VEHS) | END QUEUE (VEHS) | DELAY (VEH.MIN/TIME SEGMENT) | GEOMETRIC DELAY (VEH.MIN/TIME SEGMENT) | AVERAGE DELAY PER ARRIVING VEHICLE (MIN) |
|--|------------------|--------------------|-----------------------|----------------------------|-----------------------|------------------|------------------------------|--|--|
| 07.45-08.00 | | | | | | | | | |
| ARM A | 18.24 | 36.61 | 0.498 | | 0.0 | 1.0 | 14.4 | | 0.05 |
| ARM B | 16.66 | 35.31 | 0.472 | | 0.0 | 0.9 | 13.0 | | 0.05 |
| ARM C | 8.69 | 26.76 | 0.325 | | 0.0 | 0.5 | 7.0 | | 0.06 |
| EFFECT ON CAPACITY (PCU/MIN) OF MARGINAL CHANGES IN: | | | | | | | | | |
| | MARGINAL CHANGE: | ENTRY WIDTH (.1M) | FLARE LENGTH (M) | INSCRIBED CIRC DIAM (M) | ENTRY ANGLE (10 DEGS) | | | | |
| | ARM A | 0.517 | 0.000 | 0.017 | -1.197 | | | | |
| | ARM B | 0.206 | 0.183 | 0.068 | -1.122 | | | | |
| | ARM C | 0.195 | 0.131 | 0.070 | -0.955 | | | | |

| TIME | DEMAND (VEH/MIN) | CAPACITY (VEH/MIN) | DEMAND/ CAPACITY (RFC) | PEDESTRIAN FLOW (PEDS/MIN) | START QUEUE (VEHS) | END QUEUE (VEHS) | DELAY (VEH.MIN/ TIME SEGMENT) | GEOMETRIC DELAY (VEH.MIN/ TIME SEGMENT) | AVERAGE DELAY PER ARRIVING VEHICLE (MIN) |
|--|---------------------|-----------------------|------------------------------|----------------------------------|--------------------------|------------------------|-------------------------------------|---|--|
| 08.00-08.15 | | | | | | | | | |
| ARM A | 21.78 | 36.18 | 0.602 | | 1.0 | 1.5 | 21.8 | | 0.07 |
| ARM B | 19.90 | 33.64 | 0.591 | | 0.9 | 1.4 | 20.8 | | 0.07 |
| ARM C | 10.37 | 25.03 | 0.414 | | 0.5 | 0.7 | 10.3 | | 0.07 |
| EFFECT ON CAPACITY (PCU/MIN) OF MARGINAL CHANGES IN: | | | | | | | | | |
| | MARGINAL | ENTRY | FLARE | INSCRIBED | ENTRY | | | | |
| | CHANGE: | WIDTH | LENGTH | CIRC DIAM | ANGLE | | | | |
| | | (.1M) | (M) | (M) | (10 DEGS) | | | | |
| | ARM A | 0.514 | 0.000 | 0.021 | -1.183 | | | | |
| | ARM B | 0.201 | 0.178 | 0.081 | -1.069 | | | | |
| | ARM C | 0.189 | 0.126 | 0.084 | -0.893 | | | | |

| TIME | DEMAND (VEH/MIN) | CAPACITY (VEH/MIN) | DEMAND/ CAPACITY (RFC) | PEDESTRIAN FLOW (PEDS/MIN) | START QUEUE (VEHS) | END QUEUE (VEHS) | DELAY (VEH.MIN/ TIME SEGMENT) | GEOMETRIC DELAY (VEH.MIN/ TIME SEGMENT) | AVERAGE DELAY PER ARRIVING VEHICLE (MIN) |
|--|---------------------|-----------------------|------------------------------|----------------------------------|--------------------------|------------------------|-------------------------------------|---|--|
| 08.15-08.30 | | | | | | | | | |
| ARM A | 26.67 | 35.59 | 0.749 | | 1.5 | 2.9 | 41.1 | | 0.11 |
| ARM B | 24.37 | 31.38 | 0.777 | | 1.4 | 3.3 | 46.4 | | 0.14 |
| ARM C | 12.71 | 22.71 | 0.560 | | 0.7 | 1.3 | 18.1 | | 0.10 |
| EFFECT ON CAPACITY (PCU/MIN) OF MARGINAL CHANGES IN: | | | | | | | | | |
| | MARGINAL | ENTRY | FLARE | INSCRIBED | ENTRY | | | | |
| | CHANGE: | WIDTH | LENGTH | CIRC DIAM | ANGLE | | | | |
| | | (.1M) | (M) | (M) | (10 DEGS) | | | | |
| | ARM A | 0.509 | 0.000 | 0.026 | -1.164 | | | | |
| | ARM B | 0.193 | 0.172 | 0.099 | -0.997 | | | | |
| | ARM C | 0.180 | 0.121 | 0.103 | -0.810 | | | | |

| TIME | DEMAND (VEH/MIN) | CAPACITY (VEH/MIN) | DEMAND/ CAPACITY (RFC) | PEDESTRIAN FLOW (PEDS/MIN) | START QUEUE (VEHS) | END QUEUE (VEHS) | DELAY (VEH.MIN/ TIME SEGMENT) | GEOMETRIC DELAY (VEH.MIN/ TIME SEGMENT) | AVERAGE DELAY PER ARRIVING VEHICLE (MIN) |
|--|---------------------|-----------------------|------------------------------|----------------------------------|--------------------------|------------------------|-------------------------------------|---|--|
| 08.30-08.45 | | | | | | | | | |
| ARM A | 26.67 | 35.58 | 0.750 | | 2.9 | 2.9 | 44.0 | | 0.11 |
| ARM B | 24.37 | 31.34 | 0.778 | | 3.3 | 3.4 | 50.8 | | 0.14 |
| ARM C | 12.71 | 22.64 | 0.561 | | 1.3 | 1.3 | 18.9 | | 0.10 |
| EFFECT ON CAPACITY (PCU/MIN) OF MARGINAL CHANGES IN: | | | | | | | | | |
| | MARGINAL | ENTRY | FLARE | INSCRIBED | ENTRY | | | | |
| | CHANGE: | WIDTH | LENGTH | CIRC DIAM | ANGLE | | | | |
| | | (.1M) | (M) | (M) | (10 DEGS) | | | | |
| | ARM A | 0.509 | 0.000 | 0.026 | -1.163 | | | | |
| | ARM B | 0.193 | 0.172 | 0.099 | -0.996 | | | | |
| | ARM C | 0.180 | 0.120 | 0.103 | -0.807 | | | | |

| TIME | DEMAND (VEH/MIN) | CAPACITY (VEH/MIN) | DEMAND/ CAPACITY (RFC) | PEDESTRIAN FLOW (PEDS/MIN) | START QUEUE (VEHS) | END QUEUE (VEHS) | DELAY (VEH.MIN/ TIME SEGMENT) | GEOMETRIC DELAY (VEH.MIN/ TIME SEGMENT) | AVERAGE DELAY PER ARRIVING VEHICLE (MIN) |
|--|---------------------|-----------------------|------------------------------|----------------------------------|--------------------------|------------------------|-------------------------------------|---|--|
| 08.45-09.00 | | | | | | | | | |
| ARM A | 21.78 | 36.16 | 0.602 | | 2.9 | 1.5 | 23.8 | | 0.07 |
| ARM B | 19.90 | 33.58 | 0.593 | | 3.4 | 1.5 | 23.0 | | 0.07 |
| ARM C | 10.37 | 24.95 | 0.416 | | 1.3 | 0.7 | 11.1 | | 0.07 |
| EFFECT ON CAPACITY (PCU/MIN) OF MARGINAL CHANGES IN: | | | | | | | | | |
| | MARGINAL | ENTRY | FLARE | INSCRIBED | ENTRY | | | | |
| | CHANGE: | WIDTH | LENGTH | CIRC DIAM | ANGLE | | | | |
| | | (.1M) | (M) | (M) | (10 DEGS) | | | | |
| | ARM A | 0.514 | 0.000 | 0.021 | -1.182 | | | | |
| | ARM B | 0.201 | 0.178 | 0.081 | -1.067 | | | | |
| | ARM C | 0.188 | 0.126 | 0.085 | -0.890 | | | | |

| I | TIME | DEMAND (VEH/MIN) | CAPACITY (VEH/MIN) | DEMAND/ CAPACITY (RFC) | PEDESTRIAN FLOW (PEDS/MIN) | START QUEUE (VEHS) | END QUEUE (VEHS) | DELAY (VEH.MIN/ TIME SEGMENT) | GEOMETRIC DELAY (VEH.MIN/ TIME SEGMENT) | AVERAGE DELAY PER ARRIVING VEHICLE (MIN) | I |
|---|-------------|--|-----------------------|------------------------------|----------------------------------|--------------------------|------------------------|-------------------------------------|---|--|---|
| I | 09.00-09.15 | | | | | | | | | | I |
| I | ARM A | 18.24 | 36.60 | 0.498 | | 1.5 | 1.0 | 15.4 | | 0.05 | I |
| I | ARM B | 16.66 | 35.26 | 0.473 | | 1.5 | 0.9 | 13.8 | | 0.05 | I |
| I | ARM C | 8.69 | 26.71 | 0.325 | | 0.7 | 0.5 | 7.4 | | 0.06 | I |
| I | | EFFECT ON CAPACITY (PCU/MIN) OF MARGINAL CHANGES IN: | | | | | | | | | I |
| I | | | ENTRY | FLARE | INSCRIBED | ENTRY | | | | | I |
| I | | MARGINAL | WIDTH | LENGTH | CIRC DIAM | ANGLE | | | | | I |
| I | | CHANGE: | (.1M) | (M) | (M) | (10 DEGS) | | | | | I |
| I | | ARM A | 0.517 | 0.000 | 0.018 | -1.197 | | | | | I |
| I | | ARM B | 0.206 | 0.183 | 0.068 | -1.120 | | | | | I |
| I | | ARM C | 0.195 | 0.131 | 0.071 | -0.953 | | | | | I |

QUEUE AT ARM A

| TIME SEGMENT ENDING | NO. OF VEHICLES IN QUEUE | |
|------------------------|--------------------------------|-----|
| 08.00 | 1.0 | * |
| 08.15 | 1.5 | * |
| 08.30 | 2.9 | *** |
| 08.45 | 2.9 | *** |
| 09.00 | 1.5 | ** |
| 09.15 | 1.0 | * |

QUEUE AT ARM B

| TIME SEGMENT ENDING | NO. OF VEHICLES IN QUEUE | |
|------------------------|--------------------------------|-----|
| 08.00 | 0.9 | * |
| 08.15 | 1.4 | * |
| 08.30 | 3.3 | *** |
| 08.45 | 3.4 | *** |
| 09.00 | 1.5 | * |
| 09.15 | 0.9 | * |

QUEUE AT ARM C

| TIME SEGMENT ENDING | NO. OF VEHICLES IN QUEUE | |
|------------------------|--------------------------------|---|
| 08.00 | 0.5 | |
| 08.15 | 0.7 | * |
| 08.30 | 1.3 | * |
| 08.45 | 1.3 | * |
| 09.00 | 0.7 | * |
| 09.15 | 0.5 | |

 QUEUEING DELAY INFORMATION OVER WHOLE PERIOD

| I | ARM | I | TOTAL DEMAND | | I | * QUEUEING * | | I | * INCLUSIVE QUEUEING * | | I |
|---|-----|---|--------------|----------|---|--------------|-----------|---|------------------------|-----------|---|
| I | | I | | I | I | * DELAY * | | I | * DELAY * | | I |
| I | | I | (VEH) | (VEH/H) | I | (MIN) | (MIN/VEH) | I | (MIN) | (MIN/VEH) | I |
| I | A | I | 2000.6 | I 1333.7 | I | 160.4 | I 0.08 | I | 160.4 | I 0.08 | I |
| I | B | I | 1827.8 | I 1218.5 | I | 167.9 | I 0.09 | I | 167.9 | I 0.09 | I |
| I | C | I | 953.0 | I 635.3 | I | 72.8 | I 0.08 | I | 72.8 | I 0.08 | I |
| I | ALL | I | 4781.4 | I 3187.6 | I | 401.1 | I 0.08 | I | 401.1 | I 0.08 | I |

* DELAY IS THAT OCCURRING ONLY WITHIN THE TIME PERIOD.
 * INCLUSIVE DELAY INCLUDES DELAY SUFFERED BY VEHICLES WHICH ARE STILL QUEUEING AFTER THE END OF THE TIME PERIOD.
 * THESE WILL ONLY BE SIGNIFICANTLY DIFFERENT IF THERE IS A LARGE QUEUE REMAINING AT THE END OF THE TIME PERIOD.

END OF JOB

===== end of file =====

ARCADY 6

ASSESSMENT OF ROUNDABOUT CAPACITY AND DELAY

Analysis Program: Release 3.0 (JUNE 2005)

(c) Copyright TRL Limited, 2004

Adapted from ARCADY/3 which is Crown Copyright
by permission of the controller of HMSO

For sales and distribution information,
program advice and maintenance, contact:

TRL Limited Tel: +44 (0) 1344 770018
Crowthorne House Fax: +44 (0) 1344 770864
Nine Mile Ride Email: softwarebureau@trl.co.uk
Wokingham, Berks. Web: www.trlsoftware.co.uk
RG40 3GA,UK

THE USER OF THIS COMPUTER PROGRAM FOR THE SOLUTION OF AN ENGINEERING PROBLEM IS
IN NO WAY RELIEVED OF THEIR RESPONSIBILITY FOR THE CORRECTNESS OF THE SOLUTION

Run with file:-

"j:\120000\120669-00\4 Internal Project Data\4-04 Calculations\4-04-06 Junction Analysis\Arcady\
2028 Base + Gen Modified Roundabout\PM\B430 Roundabout - 2028 Base + Gen PM.vai"
(drive-on-the-left) at 13:34:01 on Tuesday, 14 August 2007

FILE PROPERTIES

RUN TITLE: B430 Roundabout - Junction 10 - 2028 Base + Gen PM Modified Roundabout
LOCATION: Oxfordshire
DATE: 03/08/2007
CLIENT: North Oxfordshire Consortium
ENUMERATOR: Paul Dickens
JOB NUMBER: 120669
STATUS:
DESCRIPTION:

INPUT DATA

ARM A - A43
ARM B - M40 Slips
ARM C - B430

GEOMETRIC DATA

| I | ARM | I | V (M) | I | E (M) | I | L (M) | I | R (M) | I | D (M) | I | PHI (DEG) | I | SLOPE | I | INTERCEPT (PCU/MIN) | I |
|---|-------|---|--------|---|-------|---|-------|---|-------|---|-------|---|-----------|---|-------|---|---------------------|---|
| I | ARM A | I | 7.25 * | I | 7.25 | I | 0.00 | I | 30.00 | I | 72.00 | I | 17.5 | I | 0.608 | I | 38.797 | I |
| I | ARM B | I | 6.00 | I | 9.00 | I | 18.00 | I | 50.00 | I | 72.00 | I | 12.5 | I | 0.662 | I | 43.799 | I |
| I | ARM C | I | 3.50 | I | 9.00 | I | 38.00 | I | 22.50 | I | 72.00 | I | 40.0 | I | 0.558 | I | 35.585 | I |

V = approach half-width L = effective flare length D = inscribed circle diameter
E = entry width R = entry radius PHI = entry angle

WARNING ARM C: Effective flare length is outside normal range.
Treat capacities with increasing caution.

WARNING ARM A - INPUT VALUE OF V (7.30) OUTSIDE ACCEPTABLE RANGE -
HAS BEEN RESET AS INDICATED ABOVE (*). (AG17 REF. 6.3.1).

TRAFFIC DEMAND DATA

(Only sets included in the current run are shown)

| ARM | FLOW SCALE (%) |
|-----|----------------|
| A | 100 |
| B | 100 |
| C | 100 |

TIME PERIOD BEGINS 16.45 AND ENDS 18.15

LENGTH OF TIME PERIOD - 90 MINUTES.
 LENGTH OF TIME SEGMENT - 15 MINUTES.

DEMAND FLOW PROFILES ARE SYNTHESISED FROM TURNING COUNT DATA

DEMAND SET TITLE: B430 Roundabout - Junction 10 - 2028 Base + Gen PM

| ARM | NUMBER OF MINUTES FROM START WHEN FLOW STARTS TO RISE | TOP OF PEAK IS REACHED | FLOW STOPS FALLING | RATE OF FLOW (VEH/MIN) BEFORE PEAK | AT TOP OF PEAK | AFTER PEAK |
|-------|---|------------------------|--------------------|------------------------------------|----------------|------------|
| ARM A | 15.00 | 45.00 | 75.00 | 11.15 | 16.72 | 11.15 |
| ARM B | 15.00 | 45.00 | 75.00 | 20.90 | 31.35 | 20.90 |
| ARM C | 15.00 | 45.00 | 75.00 | 9.39 | 14.08 | 9.39 |

DEMAND SET TITLE: B430 Roundabout - Junction 10 - 2028 Base + Gen PM

| TIME | TURNING PROPORTIONS | | | TURNING COUNTS (VEH/HR) | | |
|---------------|---------------------|--------|-------|-------------------------|-----------------------|----------|
| | FROM/TO | ARM A | ARM B | ARM C | (PERCENTAGE OF H.V.S) | (VEH/HR) |
| 16.45 - 18.15 | ARM A | 0.001 | 0.351 | 0.648 | | |
| | | 1.0 | 313.0 | 578.0 | (0.0) | (0.0) |
| | ARM B | 0.952 | 0.000 | 0.048 | | |
| | | 1591.0 | 0.0 | 81.0 | (0.0) | (0.0) |
| | ARM C | 0.722 | 0.278 | 0.000 | | |
| | | 542.0 | 209.0 | 0.0 | (0.0) | (0.0) |

QUEUE AND DELAY INFORMATION FOR EACH 15 MIN TIME SEGMENT

| TIME | DEMAND (VEH/MIN) | CAPACITY (VEH/MIN) | DEMAND/CAPACITY (RFC) | PEDESTRIAN FLOW (PEDS/MIN) | START QUEUE (VEHS) | END QUEUE (VEHS) | DELAY (VEH.MIN/TIME SEGMENT) | GEOMETRIC DELAY (VEH.MIN/TIME SEGMENT) | AVERAGE DELAY PER ARRIVING VEHICLE (MIN) |
|--|------------------|--------------------|-----------------------|----------------------------|-----------------------|------------------|------------------------------|--|--|
| 16.45-17.00 | | | | | | | | | |
| ARM A | 11.15 | 37.22 | 0.300 | | 0.0 | 0.4 | 6.3 | | 0.04 |
| ARM B | 20.90 | 39.02 | 0.536 | | 0.0 | 1.1 | 16.7 | | 0.05 |
| ARM C | 9.39 | 24.53 | 0.383 | | 0.0 | 0.6 | 9.0 | | 0.07 |
| EFFECT ON CAPACITY (PCU/MIN) OF MARGINAL CHANGES IN: | | | | | | | | | |
| | MARGINAL CHANGE: | ENTRY WIDTH (.1M) | FLARE LENGTH (M) | INSCRIBED CIRC DIAM (M) | ENTRY ANGLE (10 DEGS) | | | | |
| | ARM A | 0.522 | 0.000 | 0.013 | -1.217 | | | | |
| | ARM B | 0.218 | 0.194 | 0.038 | -1.240 | | | | |
| | ARM C | 0.187 | 0.125 | 0.088 | -0.875 | | | | |

| TIME | DEMAND (VEH/MIN) | CAPACITY (VEH/MIN) | DEMAND/ CAPACITY (RFC) | PEDESTRIAN FLOW (PEDS/MIN) | START QUEUE (VEHS) | END QUEUE (VEHS) | DELAY (VEH.MIN/ TIME SEGMENT) | GEOMETRIC DELAY (VEH.MIN/ TIME SEGMENT) | AVERAGE DELAY PER ARRIVING VEHICLE (MIN) |
|--|---------------------|-----------------------|------------------------------|----------------------------------|--------------------------|------------------------|-------------------------------------|---|--|
| 17.00-17.15 | | | | | | | | | |
| ARM A | 13.31 | 36.90 | 0.361 | | 0.4 | 0.6 | 8.3 | | 0.04 |
| ARM B | 24.96 | 38.08 | 0.655 | | 1.1 | 1.9 | 27.1 | | 0.08 |
| ARM C | 11.21 | 22.36 | 0.501 | | 0.6 | 1.0 | 14.5 | | 0.09 |
| EFFECT ON CAPACITY (PCU/MIN) OF MARGINAL CHANGES IN: | | | | | | | | | |
| | MARGINAL | ENTRY | FLARE | INSCRIBED | ENTRY | | | | |
| | CHANGE: | WIDTH | LENGTH | CIRC DIAM | ANGLE | | | | |
| | | (.1M) | (M) | (M) | (10 DEGS) | | | | |
| | ARM A | 0.520 | 0.000 | 0.015 | -1.207 | | | | |
| | ARM B | 0.215 | 0.191 | 0.046 | -1.210 | | | | |
| | ARM C | 0.179 | 0.120 | 0.105 | -0.797 | | | | |

| TIME | DEMAND (VEH/MIN) | CAPACITY (VEH/MIN) | DEMAND/ CAPACITY (RFC) | PEDESTRIAN FLOW (PEDS/MIN) | START QUEUE (VEHS) | END QUEUE (VEHS) | DELAY (VEH.MIN/ TIME SEGMENT) | GEOMETRIC DELAY (VEH.MIN/ TIME SEGMENT) | AVERAGE DELAY PER ARRIVING VEHICLE (MIN) |
|--|---------------------|-----------------------|------------------------------|----------------------------------|--------------------------|------------------------|-------------------------------------|---|--|
| 17.15-17.30 | | | | | | | | | |
| ARM A | 16.31 | 36.49 | 0.447 | | 0.6 | 0.8 | 11.8 | | 0.05 |
| ARM B | 30.57 | 36.80 | 0.831 | | 1.9 | 4.6 | 63.1 | | 0.15 |
| ARM C | 13.73 | 19.45 | 0.706 | | 1.0 | 2.3 | 32.2 | | 0.17 |
| EFFECT ON CAPACITY (PCU/MIN) OF MARGINAL CHANGES IN: | | | | | | | | | |
| | MARGINAL | ENTRY | FLARE | INSCRIBED | ENTRY | | | | |
| | CHANGE: | WIDTH | LENGTH | CIRC DIAM | ANGLE | | | | |
| | | (.1M) | (M) | (M) | (10 DEGS) | | | | |
| | ARM A | 0.516 | 0.000 | 0.018 | -1.193 | | | | |
| | ARM B | 0.211 | 0.188 | 0.056 | -1.170 | | | | |
| | ARM C | 0.168 | 0.112 | 0.129 | -0.693 | | | | |

| TIME | DEMAND (VEH/MIN) | CAPACITY (VEH/MIN) | DEMAND/ CAPACITY (RFC) | PEDESTRIAN FLOW (PEDS/MIN) | START QUEUE (VEHS) | END QUEUE (VEHS) | DELAY (VEH.MIN/ TIME SEGMENT) | GEOMETRIC DELAY (VEH.MIN/ TIME SEGMENT) | AVERAGE DELAY PER ARRIVING VEHICLE (MIN) |
|--|---------------------|-----------------------|------------------------------|----------------------------------|--------------------------|------------------------|-------------------------------------|---|--|
| 17.30-17.45 | | | | | | | | | |
| ARM A | 16.31 | 36.47 | 0.447 | | 0.8 | 0.8 | 12.1 | | 0.05 |
| ARM B | 30.57 | 36.79 | 0.831 | | 4.6 | 4.8 | 70.6 | | 0.16 |
| ARM C | 13.73 | 19.36 | 0.709 | | 2.3 | 2.4 | 35.3 | | 0.18 |
| EFFECT ON CAPACITY (PCU/MIN) OF MARGINAL CHANGES IN: | | | | | | | | | |
| | MARGINAL | ENTRY | FLARE | INSCRIBED | ENTRY | | | | |
| | CHANGE: | WIDTH | LENGTH | CIRC DIAM | ANGLE | | | | |
| | | (.1M) | (M) | (M) | (10 DEGS) | | | | |
| | ARM A | 0.516 | 0.000 | 0.019 | -1.193 | | | | |
| | ARM B | 0.211 | 0.188 | 0.056 | -1.169 | | | | |
| | ARM C | 0.167 | 0.112 | 0.129 | -0.690 | | | | |

| TIME | DEMAND (VEH/MIN) | CAPACITY (VEH/MIN) | DEMAND/ CAPACITY (RFC) | PEDESTRIAN FLOW (PEDS/MIN) | START QUEUE (VEHS) | END QUEUE (VEHS) | DELAY (VEH.MIN/ TIME SEGMENT) | GEOMETRIC DELAY (VEH.MIN/ TIME SEGMENT) | AVERAGE DELAY PER ARRIVING VEHICLE (MIN) |
|--|---------------------|-----------------------|------------------------------|----------------------------------|--------------------------|------------------------|-------------------------------------|---|--|
| 17.45-18.00 | | | | | | | | | |
| ARM A | 13.31 | 36.88 | 0.361 | | 0.8 | 0.6 | 8.6 | | 0.04 |
| ARM B | 24.96 | 38.07 | 0.656 | | 4.8 | 1.9 | 30.5 | | 0.08 |
| ARM C | 11.21 | 22.23 | 0.504 | | 2.4 | 1.0 | 16.1 | | 0.09 |
| EFFECT ON CAPACITY (PCU/MIN) OF MARGINAL CHANGES IN: | | | | | | | | | |
| | MARGINAL | ENTRY | FLARE | INSCRIBED | ENTRY | | | | |
| | CHANGE: | WIDTH | LENGTH | CIRC DIAM | ANGLE | | | | |
| | | (.1M) | (M) | (M) | (10 DEGS) | | | | |
| | ARM A | 0.520 | 0.000 | 0.015 | -1.206 | | | | |
| | ARM B | 0.215 | 0.191 | 0.046 | -1.210 | | | | |
| | ARM C | 0.178 | 0.119 | 0.106 | -0.793 | | | | |

| TIME | DEMAND (VEH/MIN) | CAPACITY (VEH/MIN) | DEMAND/ CAPACITY (RFC) | PEDESTRIAN FLOW (PEDS/MIN) | START QUEUE (VEHS) | END QUEUE (VEHS) | DELAY (VEH.MIN/ TIME SEGMENT) | GEOMETRIC DELAY (VEH.MIN/ TIME SEGMENT) | AVERAGE DELAY PER ARRIVING VEHICLE (MIN) |
|--|---------------------|-----------------------|------------------------------|----------------------------------|--------------------------|------------------------|-------------------------------------|---|--|
| 18.00-18.15 | | | | | | | | | |
| ARM A | 11.15 | 37.20 | 0.300 | | 0.6 | 0.4 | 6.5 | | 0.04 |
| ARM B | 20.90 | 39.01 | 0.536 | | 1.9 | 1.2 | 17.9 | | 0.06 |
| ARM C | 9.39 | 24.46 | 0.384 | | 1.0 | 0.6 | 9.6 | | 0.07 |
| EFFECT ON CAPACITY (PCU/MIN) OF MARGINAL CHANGES IN: | | | | | | | | | |
| | MARGINAL | ENTRY | FLARE | INSCRIBED | ENTRY | | | | |
| | CHANGE: | WIDTH | LENGTH | CIRC DIAM | ANGLE | | | | |
| | | (.1M) | (M) | (M) | (10 DEGS) | | | | |
| | ARM A | 0.522 | 0.000 | 0.013 | -1.217 | | | | |
| | ARM B | 0.218 | 0.194 | 0.038 | -1.240 | | | | |
| | ARM C | 0.187 | 0.125 | 0.089 | -0.873 | | | | |

QUEUE AT ARM A

| TIME SEGMENT ENDING | NO. OF VEHICLES IN QUEUE |
|------------------------|--------------------------------|
| 17.00 | 0.4 |
| 17.15 | 0.6 * |
| 17.30 | 0.8 * |
| 17.45 | 0.8 * |
| 18.00 | 0.6 * |
| 18.15 | 0.4 |

QUEUE AT ARM B

| TIME SEGMENT ENDING | NO. OF VEHICLES IN QUEUE |
|------------------------|--------------------------------|
| 17.00 | 1.1 * |
| 17.15 | 1.9 ** |
| 17.30 | 4.6 ***** |
| 17.45 | 4.8 ***** |
| 18.00 | 1.9 ** |
| 18.15 | 1.2 * |

QUEUE AT ARM C

| TIME SEGMENT ENDING | NO. OF VEHICLES IN QUEUE |
|------------------------|--------------------------------|
| 17.00 | 0.6 * |
| 17.15 | 1.0 * |
| 17.30 | 2.3 ** |
| 17.45 | 2.4 ** |
| 18.00 | 1.0 * |
| 18.15 | 0.6 * |

 QUEUEING DELAY INFORMATION OVER WHOLE PERIOD

| I | ARM | I | TOTAL DEMAND | | I | * QUEUEING * | | I | * INCLUSIVE QUEUEING * | | I |
|---|-----|---|--------------|----------|---|--------------|-----------|---|------------------------|-----------|---|
| I | | I | | I | I | * DELAY * | | I | * DELAY * | | I |
| I | | I | (VEH) | (VEH/H) | I | (MIN) | (MIN/VEH) | I | (MIN) | (MIN/VEH) | I |
| I | A | I | 1223.1 | I 815.4 | I | 53.7 | I 0.04 | I | 53.7 | I 0.04 | I |
| I | B | I | 2292.7 | I 1528.4 | I | 226.0 | I 0.10 | I | 226.0 | I 0.10 | I |
| I | C | I | 1029.8 | I 686.5 | I | 116.7 | I 0.11 | I | 116.7 | I 0.11 | I |
| I | ALL | I | 4545.6 | I 3030.4 | I | 396.4 | I 0.09 | I | 396.4 | I 0.09 | I |

* DELAY IS THAT OCCURRING ONLY WITHIN THE TIME PERIOD.
 * INCLUSIVE DELAY INCLUDES DELAY SUFFERED BY VEHICLES WHICH ARE STILL QUEUEING AFTER THE END OF THE TIME PERIOD.
 * THESE WILL ONLY BE SIGNIFICANTLY DIFFERENT IF THERE IS A LARGE QUEUE REMAINING AT THE END OF THE TIME PERIOD.

END OF JOB

===== end of file =====

Appendix F

**Camp Road: Junction
Analyses**

TRL LIMITED

(C) COPYRIGHT 2006

CAPACITIES, QUEUES, AND DELAYS AT 3 OR 4-ARM MAJOR/MINOR PRIORITY JUNCTIONS

PICADY 5.0 ANALYSIS PROGRAM
RELEASE 3.0 (JUNE 2006)

ADAPTED FROM PICADY/3 WHICH IS CROWN COPYRIGHT
BY PERMISSION OF THE CONTROLLER OF HMSO

FOR SALES AND DISTRIBUTION INFORMATION,
PROGRAM ADVICE AND MAINTENANCE CONTACT:
TRL SOFTWARE BUREAU
TEL: CROWTHORNE (01344) 770758, FAX: 770864
EMAIL: SoftwareBureau@trl.co.uk

THE USER OF THIS COMPUTER PROGRAM FOR THE SOLUTION OF AN ENGINEERING PROBLEM IS
IN NO WAY RELIEVED OF HIS RESPONSIBILITY FOR THE CORRECTNESS OF THE SOLUTION

Run with file:-
"J:\120000\120669-00\4 Internal Project Data\4-04 Calculations\4-04-06 Junction Analysis\Picady\HGV Jct\
HGV Junction - Camp Rd 2013 Base + Gen AM Flows.vpi"
(drive-on-the-left) at 10:51:50 on Monday, 6 August 2007

RUN INFORMATION

RUN TITLE: HGV Access 2013 Base + Gen AM Flows
LOCATION: Heyford
DATE: 02/08/07
CLIENT:
ENUMERATOR: chris.morris [MCCPCCP0022J]
JOB NUMBER: 120669
STATUS:
DESCRIPTION:

.MAJOR/MINOR JUNCTION CAPACITY AND DELAY

INPUT DATA

MAJOR ROAD (ARM C) ----- MAJOR ROAD (ARM A)
I
I
I
I
I
I
MINOR ROAD (ARM B)

ARM A IS Camp Raod (W)
ARM B IS HGV Access
ARM C IS Camp Road (E)

STREAM LABELLING CONVENTION

STREAM A-B CONTAINS TRAFFIC GOING FROM ARM A TO ARM B
STREAM B-AC CONTAINS TRAFFIC GOING FROM ARM B TO ARM A AND TO ARM C
ETC.

 GEOMETRIC DATA

| I | DATA ITEM | I | MINOR ROAD B | I |
|---|------------------------------------|---|----------------|---|
| I | TOTAL MAJOR ROAD CARRIAGEWAY WIDTH | I | (W) 6.00 M. | I |
| I | CENTRAL RESERVE WIDTH | I | (WCR) 0.00 M. | I |
| I | | I | | I |
| I | MAJOR ROAD RIGHT TURN - WIDTH | I | (WC-B) 3.70 M. | I |
| I | - VISIBILITY | I | (VC-B) 46.0 M. | I |
| I | - BLOCKS TRAFFIC | I | YES | I |
| I | | I | | I |
| I | MINOR ROAD - VISIBILITY TO LEFT | I | (VB-C) 70.0 M. | I |
| I | - VISIBILITY TO RIGHT | I | (VB-A) 53.0 M. | I |
| I | - LANE 1 WIDTH | I | (WB-C) - | I |
| I | - LANE 2 WIDTH | I | (WB-A) - | I |
| I | - WIDTH AT 0 M FROM JUNC. | I | 10.00 M. | I |
| I | - WIDTH AT 5 M FROM JUNC. | I | 4.50 M. | I |
| I | - WIDTH AT 10 M FROM JUNC. | I | 3.50 M. | I |
| I | - WIDTH AT 15 M FROM JUNC. | I | 3.00 M. | I |
| I | - WIDTH AT 20 M FROM JUNC. | I | 3.00 M. | I |
| I | - LENGTH OF FLARED SECTION | I | DERIVED: 0 PCU | I |

 .SLOPES AND INTERCEPT

(NB:Streams may be combined, in which case capacity will be adjusted)

| I | Intercept For Stream B-C | Slope For Opposing Stream A-C | Slope For Opposing Stream A-B | I |
|---|--------------------------|-------------------------------|-------------------------------|---|
| I | 604.66 | 0.23 | 0.09 | I |

| I | Intercept For Stream B-A | Slope For Opposing Stream A-C | Slope For Opposing Stream A-B | Slope For Opposing Stream C-A | Slope For Opposing Stream C-B | I |
|---|--------------------------|-------------------------------|-------------------------------|-------------------------------|-------------------------------|---|
| I | 484.46 | 0.22 | 0.09 | 0.14 | 0.32 | I |

| I | Intercept For Stream C-B | Slope For Opposing Stream A-C | Slope For Opposing Stream A-B | I |
|---|--------------------------|-------------------------------|-------------------------------|---|
| I | 698.65 | 0.27 | 0.27 | I |

NB These values do not allow for any site specific corrections

 TRAFFIC DEMAND DATA

| TIME | DEMAND (VEH/MIN) | CAPACITY (VEH/MIN) | DEMAND/ CAPACITY (RFC) | PEDESTRIAN FLOW (PEDS/MIN) | START QUEUE (VEHS) | END QUEUE (VEHS) | DELAY (VEH.MIN/ TIME SEGMENT) | GEOMETRIC DELAY (VEH.MIN/ TIME SEGMENT) | AVERAGE DELAY PER ARRIVING VEHICLE (MIN) |
|-------------|---------------------|-----------------------|------------------------------|----------------------------------|--------------------------|------------------------|-------------------------------------|---|--|
| 08.15-08.30 | | | | | | | | | |
| B-C | 2.64 | 8.37 | 0.316 | | 0.30 | 0.45 | 6.6 | | 0.17 |
| B-A | 1.30 | 3.51 | 0.371 | | 0.30 | 0.56 | 7.8 | | 0.45 |
| C-AB | 5.89 | 8.40 | 0.702 | | 1.13 | 2.31 | 33.1 | | 0.38 |
| A-B | 3.19 | | | | | | | | |
| A-C | 8.81 | | | | | | | | |

| TIME | DEMAND (VEH/MIN) | CAPACITY (VEH/MIN) | DEMAND/ CAPACITY (RFC) | PEDESTRIAN FLOW (PEDS/MIN) | START QUEUE (VEHS) | END QUEUE (VEHS) | DELAY (VEH.MIN/ TIME SEGMENT) | GEOMETRIC DELAY (VEH.MIN/ TIME SEGMENT) | AVERAGE DELAY PER ARRIVING VEHICLE (MIN) |
|-------------|---------------------|-----------------------|------------------------------|----------------------------------|--------------------------|------------------------|-------------------------------------|---|--|
| 08.30-08.45 | | | | | | | | | |
| B-C | 2.64 | 8.35 | 0.317 | | 0.45 | 0.46 | 6.9 | | 0.18 |
| B-A | 1.30 | 3.49 | 0.374 | | 0.56 | 0.58 | 8.6 | | 0.46 |
| C-AB | 5.89 | 8.40 | 0.702 | | 2.31 | 2.41 | 37.2 | | 0.40 |
| A-B | 3.19 | | | | | | | | |
| A-C | 8.81 | | | | | | | | |

| TIME | DEMAND (VEH/MIN) | CAPACITY (VEH/MIN) | DEMAND/ CAPACITY (RFC) | PEDESTRIAN FLOW (PEDS/MIN) | START QUEUE (VEHS) | END QUEUE (VEHS) | DELAY (VEH.MIN/ TIME SEGMENT) | GEOMETRIC DELAY (VEH.MIN/ TIME SEGMENT) | AVERAGE DELAY PER ARRIVING VEHICLE (MIN) |
|-------------|---------------------|-----------------------|------------------------------|----------------------------------|--------------------------|------------------------|-------------------------------------|---|--|
| 08.45-09.00 | | | | | | | | | |
| B-C | 2.16 | 9.15 | 0.236 | | 0.46 | 0.31 | 4.8 | | 0.14 |
| B-A | 1.06 | 4.48 | 0.237 | | 0.58 | 0.32 | 5.1 | | 0.30 |
| C-AB | 4.81 | 8.99 | 0.535 | | 2.41 | 1.20 | 18.6 | | 0.25 |
| A-B | 2.61 | | | | | | | | |
| A-C | 7.19 | | | | | | | | |

| TIME | DEMAND (VEH/MIN) | CAPACITY (VEH/MIN) | DEMAND/ CAPACITY (RFC) | PEDESTRIAN FLOW (PEDS/MIN) | START QUEUE (VEHS) | END QUEUE (VEHS) | DELAY (VEH.MIN/ TIME SEGMENT) | GEOMETRIC DELAY (VEH.MIN/ TIME SEGMENT) | AVERAGE DELAY PER ARRIVING VEHICLE (MIN) |
|-------------|---------------------|-----------------------|------------------------------|----------------------------------|--------------------------|------------------------|-------------------------------------|---|--|
| 09.00-09.15 | | | | | | | | | |
| B-C | 1.81 | 9.69 | 0.187 | | 0.31 | 0.23 | 3.6 | | 0.13 |
| B-A | 0.89 | 5.24 | 0.170 | | 0.32 | 0.21 | 3.3 | | 0.23 |
| C-AB | 4.03 | 9.42 | 0.427 | | 1.20 | 0.76 | 11.6 | | 0.19 |
| A-B | 2.18 | | | | | | | | |
| A-C | 6.02 | | | | | | | | |

QUEUE FOR STREAM B-C

| TIME SEGMENT ENDING | NO. OF VEHICLES IN QUEUE |
|------------------------|--------------------------------|
| 08.00 | 0.2 |
| 08.15 | 0.3 |
| 08.30 | 0.5 |
| 08.45 | 0.5 |
| 09.00 | 0.3 |
| 09.15 | 0.2 |

QUEUE FOR STREAM B-A

| TIME SEGMENT ENDING | NO. OF VEHICLES IN QUEUE |
|------------------------|--------------------------------|
| 08.00 | 0.2 |
| 08.15 | 0.3 |
| 08.30 | 0.6 * |
| 08.45 | 0.6 * |
| 09.00 | 0.3 |
| 09.15 | 0.2 |

 QUEUE FOR STREAM C-AB

| TIME SEGMENT ENDING | NO. OF VEHICLES IN QUEUE | |
|------------------------|--------------------------------|----|
| 08.00 | 0.7 | * |
| 08.15 | 1.1 | * |
| 08.30 | 2.3 | ** |
| 08.45 | 2.4 | ** |
| 09.00 | 1.2 | * |
| 09.15 | 0.8 | * |

 QUEUEING DELAY INFORMATION OVER WHOLE PERIOD

| I | STREAM | I | TOTAL DEMAND | I | * QUEUEING * | I | * INCLUSIVE QUEUEING * | I | | |
|---|--------|---|--------------|---------|--------------|-----------|------------------------|-----------|------|---|
| I | I | I | I | I | * DELAY * | I | * DELAY * | I | | |
| I | I | I | (VEH) | (VEH/H) | (MIN) | (MIN/VEH) | (MIN) | (MIN/VEH) | | |
| I | B-C | I | 198.2 | I | 132.1 | I | 29.5 | I | 0.15 | I |
| I | B-A | I | 97.7 | I | 65.2 | I | 31.9 | I | 0.33 | I |
| I | C-AB | I | 441.8 | I | 294.6 | I | 128.0 | I | 0.29 | I |
| I | A-B | I | 239.5 | I | 159.7 | I | | I | | I |
| I | A-C | I | 660.7 | I | 440.5 | I | | I | | I |
| I | ALL | I | 2050.9 | I | 1367.3 | I | 189.5 | I | 0.09 | I |

* DELAY IS THAT OCCURRING ONLY WITHIN THE TIME PERIOD .
 * INCLUSIVE DELAY INCLUDES DELAY SUFFERED BY VEHICLES WHICH ARE STILL QUEUEING AFTER THE END OF THE TIME PERIOD.
 * THESE WILL ONLY BE SIGNIFICANTLY DIFFERENT IF THERE IS A LARGE QUEUE REMAINING AT THE END OF THE TIME PERIOD.

END OF JOB

===== end of file =====

TRL LIMITED

(C) COPYRIGHT 2006

CAPACITIES, QUEUES, AND DELAYS AT 3 OR 4-ARM MAJOR/MINOR PRIORITY JUNCTIONS

PICADY 5.0 ANALYSIS PROGRAM
RELEASE 3.0 (JUNE 2006)

ADAPTED FROM PICADY/3 WHICH IS CROWN COPYRIGHT
BY PERMISSION OF THE CONTROLLER OF HMSO

FOR SALES AND DISTRIBUTION INFORMATION,
PROGRAM ADVICE AND MAINTENANCE CONTACT:
TRL SOFTWARE BUREAU
TEL: CROWTHORNE (01344) 770758, FAX: 770864
EMAIL: SoftwareBureau@trl.co.uk

THE USER OF THIS COMPUTER PROGRAM FOR THE SOLUTION OF AN ENGINEERING PROBLEM IS
IN NO WAY RELIEVED OF HIS RESPONSIBILITY FOR THE CORRECTNESS OF THE SOLUTION

Run with file:-
"J:\120000\120669-00\4 Internal Project Data\4-04 Calculations\4-04-06 Junction Analysis\Picady\HGV Jct\
HGV Junction - Camp Rd 2013 Base + Gen PM Flows.vpi"
(drive-on-the-left) at 10:52:57 on Monday, 6 August 2007

RUN INFORMATION

RUN TITLE: HGV Access 2013 Base + Gen PM Flows
LOCATION: Heyford
DATE: 02/08/07
CLIENT:
ENUMERATOR: chris.morris [MCCPCCP0022J]
JOB NUMBER: 120669
STATUS:
DESCRIPTION:

.MAJOR/MINOR JUNCTION CAPACITY AND DELAY

INPUT DATA

MAJOR ROAD (ARM C) ----- MAJOR ROAD (ARM A)
I
I
I
I
I
I
MINOR ROAD (ARM B)

ARM A IS Camp Raod (W)
ARM B IS HGV Access
ARM C IS Camp Road (E)

STREAM LABELLING CONVENTION

STREAM A-B CONTAINS TRAFFIC GOING FROM ARM A TO ARM B
STREAM B-AC CONTAINS TRAFFIC GOING FROM ARM B TO ARM A AND TO ARM C
ETC.

 GEOMETRIC DATA

| I | DATA ITEM | I | MINOR ROAD B | I |
|---|------------------------------------|---|----------------|---|
| I | TOTAL MAJOR ROAD CARRIAGEWAY WIDTH | I | (W) 6.00 M. | I |
| I | CENTRAL RESERVE WIDTH | I | (WCR) 0.00 M. | I |
| I | | I | | I |
| I | MAJOR ROAD RIGHT TURN - WIDTH | I | (WC-B) 3.70 M. | I |
| I | - VISIBILITY | I | (VC-B) 46.0 M. | I |
| I | - BLOCKS TRAFFIC | I | YES | I |
| I | | I | | I |
| I | MINOR ROAD - VISIBILITY TO LEFT | I | (VB-C) 70.0 M. | I |
| I | - VISIBILITY TO RIGHT | I | (VB-A) 53.0 M. | I |
| I | - LANE 1 WIDTH | I | (WB-C) - | I |
| I | - LANE 2 WIDTH | I | (WB-A) - | I |
| I | - WIDTH AT 0 M FROM JUNC. | I | 10.00 M. | I |
| I | - WIDTH AT 5 M FROM JUNC. | I | 4.50 M. | I |
| I | - WIDTH AT 10 M FROM JUNC. | I | 3.50 M. | I |
| I | - WIDTH AT 15 M FROM JUNC. | I | 3.00 M. | I |
| I | - WIDTH AT 20 M FROM JUNC. | I | 3.00 M. | I |
| I | - LENGTH OF FLARED SECTION | I | DERIVED: 0 PCU | I |

 .SLOPES AND INTERCEPT

(NB:Streams may be combined, in which case capacity will be adjusted)

| I | Intercept For Stream B-C | Slope For Opposing Stream A-C | Slope For Opposing Stream A-B | I |
|---|--------------------------|-------------------------------|-------------------------------|---|
| I | 604.66 | 0.23 | 0.09 | I |

| I | Intercept For Stream B-A | Slope For Opposing Stream A-C | Slope For Opposing Stream A-B | Slope For Opposing Stream C-A | Slope For Opposing Stream C-B | I |
|---|--------------------------|-------------------------------|-------------------------------|-------------------------------|-------------------------------|---|
| I | 484.46 | 0.22 | 0.09 | 0.14 | 0.32 | I |

| I | Intercept For Stream C-B | Slope For Opposing Stream A-C | Slope For Opposing Stream A-B | I |
|---|--------------------------|-------------------------------|-------------------------------|---|
| I | 698.65 | 0.27 | 0.27 | I |

NB These values do not allow for any site specific corrections

 TRAFFIC DEMAND DATA

| TIME | DEMAND (VEH/MIN) | CAPACITY (VEH/MIN) | DEMAND/ CAPACITY (RFC) | PEDESTRIAN FLOW (PEDS/MIN) | START QUEUE (VEHS) | END QUEUE (VEHS) | DELAY (VEH.MIN/ TIME SEGMENT) | GEOMETRIC DELAY (VEH.MIN/ TIME SEGMENT) | AVERAGE DELAY PER ARRIVING VEHICLE (MIN) |
|-------------|---------------------|-----------------------|------------------------------|----------------------------------|--------------------------|------------------------|-------------------------------------|---|--|
| 17.15-17.30 | | | | | | | | | |
| B-C | 5.51 | 8.53 | 0.646 | | 0.92 | 1.72 | 23.7 | | 0.32 |
| B-A | 2.95 | 5.14 | 0.575 | | 0.68 | 1.27 | 17.4 | | 0.44 |
| C-AB | 2.64 | 9.45 | 0.280 | | 0.28 | 0.38 | 5.7 | | 0.15 |
| A-B | 1.38 | | | | | | | | |
| A-C | 6.72 | | | | | | | | |

| TIME | DEMAND (VEH/MIN) | CAPACITY (VEH/MIN) | DEMAND/ CAPACITY (RFC) | PEDESTRIAN FLOW (PEDS/MIN) | START QUEUE (VEHS) | END QUEUE (VEHS) | DELAY (VEH.MIN/ TIME SEGMENT) | GEOMETRIC DELAY (VEH.MIN/ TIME SEGMENT) | AVERAGE DELAY PER ARRIVING VEHICLE (MIN) |
|-------------|---------------------|-----------------------|------------------------------|----------------------------------|--------------------------|------------------------|-------------------------------------|---|--|
| 17.30-17.45 | | | | | | | | | |
| B-C | 5.51 | 8.51 | 0.647 | | 1.72 | 1.78 | 26.3 | | 0.33 |
| B-A | 2.95 | 5.13 | 0.576 | | 1.27 | 1.31 | 19.4 | | 0.46 |
| C-AB | 2.64 | 9.45 | 0.280 | | 0.38 | 0.39 | 5.8 | | 0.15 |
| A-B | 1.38 | | | | | | | | |
| A-C | 6.72 | | | | | | | | |

| TIME | DEMAND (VEH/MIN) | CAPACITY (VEH/MIN) | DEMAND/ CAPACITY (RFC) | PEDESTRIAN FLOW (PEDS/MIN) | START QUEUE (VEHS) | END QUEUE (VEHS) | DELAY (VEH.MIN/ TIME SEGMENT) | GEOMETRIC DELAY (VEH.MIN/ TIME SEGMENT) | AVERAGE DELAY PER ARRIVING VEHICLE (MIN) |
|-------------|---------------------|-----------------------|------------------------------|----------------------------------|--------------------------|------------------------|-------------------------------------|---|--|
| 17.45-18.00 | | | | | | | | | |
| B-C | 4.49 | 9.25 | 0.486 | | 1.78 | 0.97 | 15.5 | | 0.22 |
| B-A | 2.41 | 5.85 | 0.413 | | 1.31 | 0.72 | 11.6 | | 0.30 |
| C-AB | 2.16 | 9.86 | 0.219 | | 0.39 | 0.28 | 4.3 | | 0.13 |
| A-B | 1.12 | | | | | | | | |
| A-C | 5.48 | | | | | | | | |

| TIME | DEMAND (VEH/MIN) | CAPACITY (VEH/MIN) | DEMAND/ CAPACITY (RFC) | PEDESTRIAN FLOW (PEDS/MIN) | START QUEUE (VEHS) | END QUEUE (VEHS) | DELAY (VEH.MIN/ TIME SEGMENT) | GEOMETRIC DELAY (VEH.MIN/ TIME SEGMENT) | AVERAGE DELAY PER ARRIVING VEHICLE (MIN) |
|-------------|---------------------|-----------------------|------------------------------|----------------------------------|--------------------------|------------------------|-------------------------------------|---|--|
| 18.00-18.15 | | | | | | | | | |
| B-C | 3.76 | 9.76 | 0.386 | | 0.97 | 0.64 | 10.0 | | 0.17 |
| B-A | 2.02 | 6.36 | 0.317 | | 0.72 | 0.48 | 7.5 | | 0.23 |
| C-AB | 1.81 | 10.15 | 0.178 | | 0.28 | 0.22 | 3.3 | | 0.12 |
| A-B | 0.94 | | | | | | | | |
| A-C | 4.59 | | | | | | | | |

QUEUE FOR STREAM B-C

| TIME SEGMENT ENDING | NO. OF VEHICLES IN QUEUE |
|------------------------|--------------------------------|
| 17.00 | 0.6 * |
| 17.15 | 0.9 * |
| 17.30 | 1.7 ** |
| 17.45 | 1.8 ** |
| 18.00 | 1.0 * |
| 18.15 | 0.6 * |

QUEUE FOR STREAM B-A

| TIME SEGMENT ENDING | NO. OF VEHICLES IN QUEUE |
|------------------------|--------------------------------|
| 17.00 | 0.5 |
| 17.15 | 0.7 * |
| 17.30 | 1.3 * |
| 17.45 | 1.3 * |
| 18.00 | 0.7 * |
| 18.15 | 0.5 |

QUEUE FOR STREAM C-AB

| TIME SEGMENT ENDING | NO. OF VEHICLES IN QUEUE |
|---------------------|--------------------------|
| 17.00 | 0.2 |
| 17.15 | 0.3 |
| 17.30 | 0.4 |
| 17.45 | 0.4 |
| 18.00 | 0.3 |
| 18.15 | 0.2 |

QUEUEING DELAY INFORMATION OVER WHOLE PERIOD

| I | STREAM | I | TOTAL DEMAND | I | * QUEUEING * * DELAY * | I | * INCLUSIVE QUEUEING * * DELAY * | I | | | | | | |
|---|--------|---|--------------|---------|---------------------------|-----------|-------------------------------------|-----------|------|---|-------|---|------|---|
| I | I | I | I | I | I | I | I | I | | | | | | |
| I | I | I | (VEH) | (VEH/H) | (MIN) | (MIN/VEH) | (MIN) | (MIN/VEH) | | | | | | |
| I | B-C | I | 412.9 | I | 275.3 | I | 97.3 | I | 0.24 | I | 97.4 | I | 0.24 | I |
| I | B-A | I | 221.6 | I | 147.7 | I | 72.0 | I | 0.32 | I | 72.0 | I | 0.32 | I |
| I | C-AB | I | 198.2 | I | 132.1 | I | 26.5 | I | 0.13 | I | 26.5 | I | 0.13 | I |
| I | A-B | I | 103.2 | I | 68.8 | I | | I | | I | | I | | I |
| I | A-C | I | 503.8 | I | 335.8 | I | | I | | I | | I | | I |
| I | ALL | I | 1982.1 | I | 1321.4 | I | 195.8 | I | 0.10 | I | 195.8 | I | 0.10 | I |

* DELAY IS THAT OCCURRING ONLY WITHIN THE TIME PERIOD .
 * INCLUSIVE DELAY INCLUDES DELAY SUFFERED BY VEHICLES WHICH ARE STILL QUEUEING AFTER THE END OF THE TIME PERIOD.
 * THESE WILL ONLY BE SIGNIFICANTLY DIFFERENT IF THERE IS A LARGE QUEUE REMAINING AT THE END OF THE TIME PERIOD.

END OF JOB

===== end of file =====

TRL LIMITED

(C) COPYRIGHT 2006

CAPACITIES, QUEUES, AND DELAYS AT 3 OR 4-ARM MAJOR/MINOR PRIORITY JUNCTIONS

PICADY 5.0 ANALYSIS PROGRAM
RELEASE 3.0 (JUNE 2006)

ADAPTED FROM PICADY/3 WHICH IS CROWN COPYRIGHT
BY PERMISSION OF THE CONTROLLER OF HMSO

FOR SALES AND DISTRIBUTION INFORMATION,
PROGRAM ADVICE AND MAINTENANCE CONTACT:
TRL SOFTWARE BUREAU
TEL: CROWTHORNE (01344) 770758, FAX: 770864
EMAIL: SoftwareBureau@trl.co.uk

THE USER OF THIS COMPUTER PROGRAM FOR THE SOLUTION OF AN ENGINEERING PROBLEM IS
IN NO WAY RELIEVED OF HIS RESPONSIBILITY FOR THE CORRECTNESS OF THE SOLUTION

Run with file:-

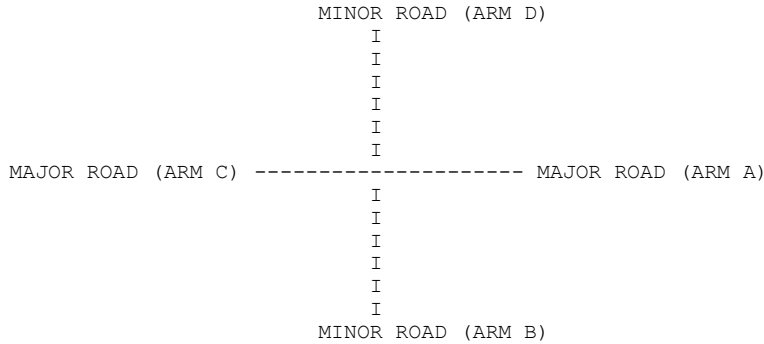
"J:\120000\120669-00\4 Internal Project Data\4-04 Calculations\4-04-06 Junction Analysis\Picady\Larsen Road Jct\
Larsen Rd - Camp Rd Junction 2013 Base + Gen AM Flows.vpi"
(drive-on-the-left) at 10:10:15 on Monday, 6 August 2007

RUN INFORMATION

RUN TITLE: Camp Rd - Larsen Rd Junction 2013 Base + Gen AM Flows
LOCATION: Heyford
DATE: 02/08/07
CLIENT:
ENUMERATOR: chris.morris [MCCPCCP0022J]
JOB NUMBER: 120669
STATUS:
DESCRIPTION:

.MAJOR/MINOR JUNCTION CAPACITY AND DELAY

INPUT DATA



ARM A IS Camp Road (W)
ARM B IS Larsen Road (N)
ARM C IS Camp Road (E)
ARM D IS Unnamed Road (S)

STREAM LABELLING CONVENTION

STREAM A-B CONTAINS TRAFFIC GOING FROM ARM A TO ARM B
STREAM B-AC CONTAINS TRAFFIC GOING FROM ARM B TO ARM A AND TO ARM C
ETC.

 GEOMETRIC DATA

| I | DATA ITEM | I | MINOR ROAD B | I | MINOR ROAD D | I |
|---|------------------------------------|---|----------------|---|----------------|---|
| I | TOTAL MAJOR ROAD CARRIAGEWAY WIDTH | I | (W) 6.00 M. | I | (W) 6.00 M. | I |
| I | CENTRAL RESERVE WIDTH | I | (WCR) 0.00 M. | I | (WCR) 0.00 M. | I |
| I | | I | | I | | I |
| I | MAJOR ROAD RIGHT TURN - WIDTH | I | (WC-B) 2.20 M. | I | (WA-D) 2.20 M. | I |
| I | - VISIBILITY | I | (VC-B) 93.0 M. | I | (VA-D) 77.0 M. | I |
| I | - BLOCKS TRAFFIC | I | YES | I | YES | I |
| I | | I | | I | | I |
| I | MINOR ROAD - VISIBILITY TO LEFT | I | (VB-C) 27.0 M. | I | (VD-A) 24.0 M. | I |
| I | - VISIBILITY TO RIGHT | I | (VB-A) 19.0 M. | I | (VD-C) 79.0 M. | I |
| I | - LANE 1 WIDTH | I | (WB-C) - | I | (WD-A) - | I |
| I | - LANE 2 WIDTH | I | (WB-A) - | I | (WD-C) - | I |
| I | - WIDTH AT 0 M FROM JUNC. | I | 10.00 M. | I | 7.50 M. | I |
| I | - WIDTH AT 5 M FROM JUNC. | I | 3.75 M. | I | 3.00 M. | I |
| I | - WIDTH AT 10 M FROM JUNC. | I | 3.00 M. | I | 3.00 M. | I |
| I | - WIDTH AT 15 M FROM JUNC. | I | 3.00 M. | I | 3.00 M. | I |
| I | - WIDTH AT 20 M FROM JUNC. | I | 3.00 M. | I | 3.00 M. | I |
| I | - LENGTH OF FLARED SECTION | I | DERIVED: 0 PCU | I | DERIVED: 0 PCU | I |

.SLOPES AND INTERCPET

(NB:Streams may be combined, in which case capacity will be adjusted)

B-C Stream

| I | Intercept For Stream B-C | Slope For Opposing Stream A-C | Slope For Opposing Stream A-B | I |
|---|--------------------------|-------------------------------|-------------------------------|---|
| I | 584.97 | 0.23 | 0.09 | I |

D-A Stream

| I | Intercept For Stream D-A | Slope For Opposing Stream C-A | Slope For Opposing Stream C-D | I |
|---|--------------------------|-------------------------------|-------------------------------|---|
| I | 619.71 | 0.24 | 0.09 | I |

B-A Stream

| I | Intercept For Stream B-A | Slope For Opposing Stream A-C | Slope For Opposing Stream A-D | Slope For Opposing Stream D-A | Slope For Opposing Stream D-B | I |
|---|--------------------------|-------------------------------|-------------------------------|-------------------------------|-------------------------------|---|
| I | 455.98 | 0.21 | 0.21 | 0.21 | 0.21 | I |

| I | Slope For Opposing Stream A-B | Slope For Opposing Stream C-A | Slope For Opposing Stream C-B | Slope For Opposing Stream D-C | I |
|---|-------------------------------|-------------------------------|-------------------------------|-------------------------------|---|
| I | 0.08 | 0.13 | 0.30 | 0.10 | I |

D-C Stream

| I | Intercept For Stream D-C | Slope For Opposing Stream C-A | Slope For Opposing Stream C-B | Slope For Opposing Stream B-C | Slope For Opposing Stream B-D | I |
|---|--------------------------|-------------------------------|-------------------------------|-------------------------------|-------------------------------|---|
| I | 482.13 | 0.22 | 0.22 | 0.22 | 0.22 | I |

| I | Slope For Opposing Stream C-D | Slope For Opposing Stream A-C | Slope For Opposing Stream A-D | Slope For Opposing Stream B-A | I |
|---|-------------------------------|-------------------------------|-------------------------------|-------------------------------|---|
| I | 0.09 | 0.14 | 0.32 | 0.11 | I |

C-B Stream

| I | Intercept For Stream C-B | Slope For Opposing Stream A-C | Slope For Opposing Stream A-D | I |
|---|--------------------------|-------------------------------|-------------------------------|---|
| I | 627.82 | 0.24 | 0.35 | I |

A-D Stream

| I | Intercept For Stream A-D | Slope For Opposing Stream C-A | Slope For Opposing Stream C-B | I |
|---|--------------------------|-------------------------------|-------------------------------|---|
| I | 618.55 | 0.24 | 0.34 | I |

B-D Stream From Left Hand Lane

| I | Intercept For Stream B-D | Slope For Opposing Stream A-C | Slope For Opposing Stream A-D | Slope For Opposing Stream A-B | Slope For Opposing Stream C-B | I |
|---|--------------------------|-------------------------------|-------------------------------|-------------------------------|-------------------------------|---|
| I | 455.98 | 0.21 | 0.21 | 0.08 | 0.30 | I |

| I | Slope For Opposing Stream C-A | Slope For Opposing Stream C-D | Slope For Opposing Stream C-B | I |
|---|-------------------------------|-------------------------------|-------------------------------|---|
| I | 0.13 | 0.13 | | I |

B-D Stream From Right Hand Lane

| I | Intercept For Stream B-D | Slope For Opposing Stream A-C | Slope For Opposing Stream A-D | Slope For Opposing Stream A-B | Slope For Opposing Stream C-B | I |
|---|--------------------------|-------------------------------|-------------------------------|-------------------------------|-------------------------------|---|
| I | 455.98 | 0.21 | 0.21 | 0.08 | 0.30 | I |

| I | Slope For Opposing Stream C-A | Slope For Opposing Stream C-D | Slope For Opposing Stream C-B | I |
|---|-------------------------------|-------------------------------|-------------------------------|---|
| I | 0.13 | 0.13 | | I |

D-B Stream From Left Hand Lane

| I | Intercept For Stream D-B | Slope For Opposing Stream C-A | Slope For Opposing Stream C-B | Slope For Opposing Stream D-C | Slope For Opposing Stream A-D | I |
|---|--------------------------|-------------------------------|-------------------------------|-------------------------------|-------------------------------|---|
| I | 482.13 | 0.22 | 0.22 | 0.09 | 0.32 | I |

| I | Slope For Opposing Stream A-C | Slope For Opposing Stream A-B | Slope For Opposing Stream A-D | I |
|---|-------------------------------|-------------------------------|-------------------------------|---|
| I | 0.14 | 0.14 | | I |

D-B Stream From Right Hand Lane

| I | Intercept For Stream D-B | Slope For Opposing Stream C-A | Slope For Opposing Stream C-B | Slope For Opposing Stream C-D | Slope For Opposing Stream A-D | I |
|---|--------------------------|-------------------------------|-------------------------------|-------------------------------|-------------------------------|---|
| I | 482.13 | 0.22 | 0.22 | 0.09 | 0.32 | I |

| I | Slope For Opposing Stream A-C | Slope For Opposing Stream A-B | Slope For Opposing Stream A-D | I |
|---|-------------------------------|-------------------------------|-------------------------------|---|
| I | 0.14 | 0.14 | | I |

TRAFFIC DEMAND DATA

| I | TIME | DEMAND (VEH/MIN) | CAPACITY (VEH/MIN) | DEMAND/ CAPACITY (RFC) | PEDESTRIAN FLOW (PEDS/MIN) | START QUEUE (VEHS) | END QUEUE (VEHS) | DELAY (VEH.MIN/ TIME SEGMENT) | GEOMETRIC DELAY (VEH.MIN/ TIME SEGMENT) | AVERAGE DELAY PER ARRIVING VEHICLE (MIN) | I |
|---|-------------|---------------------|-----------------------|------------------------------|----------------------------------|--------------------------|------------------------|-------------------------------------|---|--|---|
| I | 09.00-09.15 | | | | | | | | | | I |
| I | B-CD | 0.15 | 9.11 | 0.017 | | 0.02 | 0.02 | 0.3 | | 0.11 | I |
| I | B-AD | 0.08 | 6.39 | 0.012 | | 0.02 | 0.01 | 0.2 | | 0.16 | I |
| I | A-BCD | 0.03 | 13.83 | 0.002 | | 0.00 | 0.00 | 0.0 | | 0.07 | I |
| I | A-B | 0.03 | | | | | | | | | I |
| I | A-C | 7.85 | | | | | | | | | I |
| I | D-AB | 0.08 | 9.19 | 0.008 | | 0.01 | 0.01 | 0.1 | | 0.11 | I |
| I | D-BC | 0.11 | 5.80 | 0.019 | | 0.03 | 0.02 | 0.3 | | 0.18 | I |
| I | C-ABD | 0.08 | 13.75 | 0.006 | | 0.01 | 0.01 | 0.1 | | 0.07 | I |
| I | C-D | 0.02 | | | | | | | | | I |
| I | C-A | 7.60 | | | | | | | | | I |

WARNING NO MARGINAL ANALYSIS OF CAPACITIES AS MAJOR ROAD BLOCKING MAY OCCUR

QUEUE FOR STREAM B-CD

| TIME SEGMENT ENDING | NO. OF VEHICLES IN QUEUE |
|------------------------|--------------------------------|
| 08.00 | 0.0 |
| 08.15 | 0.0 |
| 08.30 | 0.0 |
| 08.45 | 0.0 |
| 09.00 | 0.0 |
| 09.15 | 0.0 |

QUEUE FOR STREAM B-AD

| TIME SEGMENT ENDING | NO. OF VEHICLES IN QUEUE |
|------------------------|--------------------------------|
| 08.00 | 0.0 |
| 08.15 | 0.0 |
| 08.30 | 0.0 |
| 08.45 | 0.0 |
| 09.00 | 0.0 |
| 09.15 | 0.0 |

QUEUE FOR STREAM A-BCD

| TIME SEGMENT ENDING | NO. OF VEHICLES IN QUEUE |
|------------------------|--------------------------------|
| 08.00 | 0.0 |
| 08.15 | 0.0 |
| 08.30 | 0.0 |
| 08.45 | 0.0 |
| 09.00 | 0.0 |
| 09.15 | 0.0 |

QUEUE FOR STREAM D-AB

| TIME SEGMENT ENDING | NO. OF VEHICLES IN QUEUE |
|------------------------|--------------------------------|
| 08.00 | 0.0 |
| 08.15 | 0.0 |
| 08.30 | 0.0 |
| 08.45 | 0.0 |
| 09.00 | 0.0 |
| 09.15 | 0.0 |

QUEUE FOR STREAM D-BC

| TIME SEGMENT ENDING | NO. OF VEHICLES IN QUEUE |
|------------------------|--------------------------------|
| 08.00 | 0.0 |
| 08.15 | 0.0 |
| 08.30 | 0.0 |
| 08.45 | 0.0 |
| 09.00 | 0.0 |
| 09.15 | 0.0 |

QUEUE FOR STREAM C-ABD

| TIME SEGMENT ENDING | NO. OF VEHICLES IN QUEUE |
|---------------------|--------------------------|
| 08.00 | 0.0 |
| 08.15 | 0.0 |
| 08.30 | 0.0 |
| 08.45 | 0.0 |
| 09.00 | 0.0 |
| 09.15 | 0.0 |

QUEUEING DELAY INFORMATION OVER WHOLE PERIOD

| I | STREAM | I | TOTAL DEMAND | I | * QUEUEING * * DELAY * | I | * INCLUSIVE QUEUEING * * DELAY * | I | |
|---|--------|---|--------------|----------|---------------------------|-----------|-------------------------------------|-----------|---|
| I | I | I | I | I | I | I | I | I | |
| I | I | I | (VEH) | (VEH/H) | (MIN) | (MIN/VEH) | (MIN) | (MIN/VEH) | |
| I | B-CD | I | 16.5 | I 11.0 | I 2.0 | I 0.12 | I 2.0 | I 0.12 | I |
| I | B-AD | I | 8.3 | I 5.5 | I 1.5 | I 0.19 | I 1.5 | I 0.19 | I |
| I | A-BCD | I | 3.4 | I 2.3 | I 0.2 | I 0.07 | I 0.2 | I 0.07 | I |
| I | A-B | I | 2.7 | I 1.8 | I | I | I | I | I |
| I | A-C | I | 861.0 | I 574.0 | I | I | I | I | I |
| I | D-AB | I | 8.3 | I 5.5 | I 1.0 | I 0.12 | I 1.0 | I 0.12 | I |
| I | D-BC | I | 12.4 | I 8.3 | I 2.5 | I 0.21 | I 2.5 | I 0.21 | I |
| I | C-ABD | I | 9.9 | I 6.6 | I 0.7 | I 0.07 | I 0.7 | I 0.07 | I |
| I | C-D | I | 2.7 | I 1.8 | I | I | I | I | I |
| I | C-A | I | 832.5 | I 555.0 | I | I | I | I | I |
| I | ALL | I | 1757.7 | I 1171.8 | I 8.0 | I 0.00 | I 8.0 | I 0.00 | I |

* DELAY IS THAT OCCURRING ONLY WITHIN THE TIME PERIOD .
 * INCLUSIVE DELAY INCLUDES DELAY SUFFERED BY VEHICLES WHICH ARE STILL QUEUEING AFTER THE END OF THE TIME PERIOD.
 * THESE WILL ONLY BE SIGNIFICANTLY DIFFERENT IF THERE IS A LARGE QUEUE REMAINING AT THE END OF THE TIME PERIOD.

END OF JOB

===== end of file =====

TRL LIMITED

(C) COPYRIGHT 2006

CAPACITIES, QUEUES, AND DELAYS AT 3 OR 4-ARM MAJOR/MINOR PRIORITY JUNCTIONS

PICADY 5.0 ANALYSIS PROGRAM
RELEASE 3.0 (JUNE 2006)

ADAPTED FROM PICADY/3 WHICH IS CROWN COPYRIGHT
BY PERMISSION OF THE CONTROLLER OF HMSO

FOR SALES AND DISTRIBUTION INFORMATION,
PROGRAM ADVICE AND MAINTENANCE CONTACT:
TRL SOFTWARE BUREAU
TEL: CROWTHORNE (01344) 770758, FAX: 770864
EMAIL: SoftwareBureau@trl.co.uk

THE USER OF THIS COMPUTER PROGRAM FOR THE SOLUTION OF AN ENGINEERING PROBLEM IS
IN NO WAY RELIEVED OF HIS RESPONSIBILITY FOR THE CORRECTNESS OF THE SOLUTION

Run with file:-

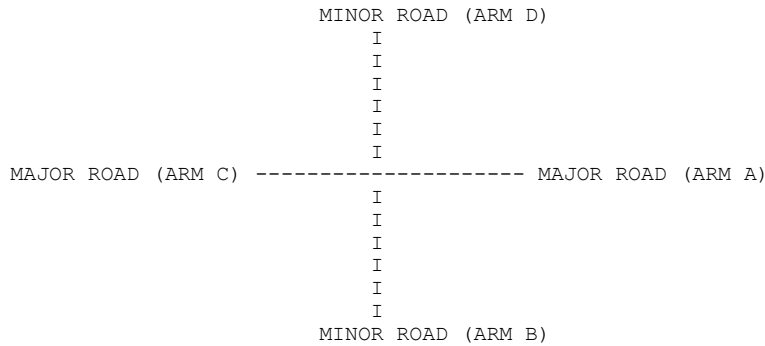
"J:\120000\120669-00\4 Internal Project Data\4-04 Calculations\4-04-06 Junction Analysis\Picady\Larsen Road Jct\
Larsen Rd - Camp Rd Junction 2013 Base + Gen PM Flows.vpi"
(drive-on-the-left) at 10:10:31 on Monday, 6 August 2007

RUN INFORMATION

RUN TITLE: Camp Rd - Larsen Rd Junction 2013 Base + Gen PM Flows
LOCATION: Heyford
DATE: 02/08/07
CLIENT:
ENUMERATOR: chris.morris [MCCPCCP0022J]
JOB NUMBER: 120669
STATUS:
DESCRIPTION:

.MAJOR/MINOR JUNCTION CAPACITY AND DELAY

INPUT DATA



ARM A IS Camp Road (W)
ARM B IS Larsen Road (N)
ARM C IS Camp Road (E)
ARM D IS Unnamed Road (S)

STREAM LABELLING CONVENTION

STREAM A-B CONTAINS TRAFFIC GOING FROM ARM A TO ARM B
STREAM B-AC CONTAINS TRAFFIC GOING FROM ARM B TO ARM A AND TO ARM C
ETC.

 GEOMETRIC DATA

| I | DATA ITEM | I | MINOR ROAD B | I | MINOR ROAD D | I |
|---|------------------------------------|---|----------------|---|----------------|---|
| I | TOTAL MAJOR ROAD CARRIAGEWAY WIDTH | I | (W) 6.00 M. | I | (W) 6.00 M. | I |
| I | CENTRAL RESERVE WIDTH | I | (WCR) 0.00 M. | I | (WCR) 0.00 M. | I |
| I | | I | | I | | I |
| I | MAJOR ROAD RIGHT TURN - WIDTH | I | (WC-B) 2.20 M. | I | (WA-D) 2.20 M. | I |
| I | - VISIBILITY | I | (VC-B) 93.0 M. | I | (VA-D) 77.0 M. | I |
| I | - BLOCKS TRAFFIC | I | YES | I | YES | I |
| I | | I | | I | | I |
| I | MINOR ROAD - VISIBILITY TO LEFT | I | (VB-C) 27.0 M. | I | (VD-A) 24.0 M. | I |
| I | - VISIBILITY TO RIGHT | I | (VB-A) 19.0 M. | I | (VD-C) 79.0 M. | I |
| I | - LANE 1 WIDTH | I | (WB-C) - | I | (WD-A) - | I |
| I | - LANE 2 WIDTH | I | (WB-A) - | I | (WD-C) - | I |
| I | - WIDTH AT 0 M FROM JUNC. | I | 10.00 M. | I | 7.50 M. | I |
| I | - WIDTH AT 5 M FROM JUNC. | I | 3.75 M. | I | 3.00 M. | I |
| I | - WIDTH AT 10 M FROM JUNC. | I | 3.00 M. | I | 3.00 M. | I |
| I | - WIDTH AT 15 M FROM JUNC. | I | 3.00 M. | I | 3.00 M. | I |
| I | - WIDTH AT 20 M FROM JUNC. | I | 3.00 M. | I | 3.00 M. | I |
| I | - LENGTH OF FLARED SECTION | I | DERIVED: 0 PCU | I | DERIVED: 0 PCU | I |

.SLOPES AND INTERCPET

(NB:Streams may be combined, in which case capacity will be adjusted)

B-C Stream

| I | Intercept For Stream B-C | Slope For Opposing Stream A-C | Slope For Opposing Stream A-B | I |
|---|--------------------------|-------------------------------|-------------------------------|---|
| I | 584.97 | 0.23 | 0.09 | I |

D-A Stream

| I | Intercept For Stream D-A | Slope For Opposing Stream C-A | Slope For Opposing Stream C-D | I |
|---|--------------------------|-------------------------------|-------------------------------|---|
| I | 619.71 | 0.24 | 0.09 | I |

B-A Stream

| I | Intercept For Stream B-A | Slope For Opposing Stream A-C | Slope For Opposing Stream A-D | Slope For Opposing Stream D-A | Slope For Opposing Stream D-B | I |
|---|--------------------------|-------------------------------|-------------------------------|-------------------------------|-------------------------------|---|
| I | 455.98 | 0.21 | 0.21 | 0.21 | 0.21 | I |

| I | Slope For Opposing Stream A-B | Slope For Opposing Stream C-A | Slope For Opposing Stream C-B | Slope For Opposing Stream D-C | I |
|---|-------------------------------|-------------------------------|-------------------------------|-------------------------------|---|
| I | 0.08 | 0.13 | 0.30 | 0.10 | I |

D-C Stream

| I | Intercept For Stream D-C | Slope For Opposing Stream C-A | Slope For Opposing Stream C-B | Slope For Opposing Stream B-C | Slope For Opposing Stream B-D | I |
|---|--------------------------|-------------------------------|-------------------------------|-------------------------------|-------------------------------|---|
| I | 482.13 | 0.22 | 0.22 | 0.22 | 0.22 | I |

| I | Slope For Opposing Stream C-D | Slope For Opposing Stream A-C | Slope For Opposing Stream A-D | Slope For Opposing Stream B-A | I |
|---|-------------------------------|-------------------------------|-------------------------------|-------------------------------|---|
| I | 0.09 | 0.14 | 0.32 | 0.11 | I |

C-B Stream

| I | Intercept For Stream C-B | Slope For Opposing Stream A-C | Slope For Opposing Stream A-D | I |
|---|--------------------------|-------------------------------|-------------------------------|---|
| I | 627.82 | 0.24 | 0.35 | I |

A-D Stream

| I | Intercept For Stream A-D | Slope For Opposing Stream C-A | Slope For Opposing Stream C-B | I |
|---|--------------------------|-------------------------------|-------------------------------|---|
| I | 618.55 | 0.24 | 0.34 | I |

B-D Stream From Left Hand Lane

| I | Intercept For Stream B-D | Slope For Opposing Stream A-C | Slope For Opposing Stream A-D | Slope For Opposing Stream A-B | Slope For Opposing Stream C-B | I |
|---|--------------------------|-------------------------------|-------------------------------|-------------------------------|-------------------------------|---|
| I | 455.98 | 0.21 | 0.21 | 0.08 | 0.30 | I |

| I | Slope For Opposing Stream C-A | Slope For Opposing Stream C-D | Slope For Opposing Stream C-B | I |
|---|-------------------------------|-------------------------------|-------------------------------|---|
| I | 0.13 | 0.13 | | I |

B-D Stream From Right Hand Lane

| I | Intercept For Stream B-D | Slope For Opposing Stream A-C | Slope For Opposing Stream A-D | Slope For Opposing Stream A-B | Slope For Opposing Stream C-B | I |
|---|--------------------------|-------------------------------|-------------------------------|-------------------------------|-------------------------------|---|
| I | 455.98 | 0.21 | 0.21 | 0.08 | 0.30 | I |

| I | Slope For Opposing Stream C-A | Slope For Opposing Stream C-D | Slope For Opposing Stream C-B | I |
|---|-------------------------------|-------------------------------|-------------------------------|---|
| I | 0.13 | 0.13 | | I |

D-B Stream From Left Hand Lane

| I | Intercept For Stream D-B | Slope For Opposing Stream C-A | Slope For Opposing Stream C-B | Slope For Opposing Stream D-C | Slope For Opposing Stream A-D | I |
|---|--------------------------|-------------------------------|-------------------------------|-------------------------------|-------------------------------|---|
| I | 482.13 | 0.22 | 0.22 | 0.09 | 0.32 | I |

| I | Slope For Opposing Stream A-C | Slope For Opposing Stream A-B | Slope For Opposing Stream C-B | I |
|---|-------------------------------|-------------------------------|-------------------------------|---|
| I | 0.14 | 0.14 | | I |

D-B Stream From Right Hand Lane

| I | Intercept For Stream D-B | Slope For Opposing Stream C-A | Slope For Opposing Stream C-B | Slope For Opposing Stream C-D | Slope For Opposing Stream A-D | I |
|---|--------------------------|-------------------------------|-------------------------------|-------------------------------|-------------------------------|---|
| I | 482.13 | 0.22 | 0.22 | 0.09 | 0.32 | I |

| I | Slope For Opposing Stream A-C | Slope For Opposing Stream A-B | Slope For Opposing Stream C-B | I |
|---|-------------------------------|-------------------------------|-------------------------------|---|
| I | 0.14 | 0.14 | | I |

TRAFFIC DEMAND DATA

| I | TIME | DEMAND (VEH/MIN) | CAPACITY (VEH/MIN) | DEMAND/ CAPACITY (RFC) | PEDESTRIAN FLOW (PEDS/MIN) | START QUEUE (VEHS) | END QUEUE (VEHS) | DELAY (VEH.MIN/ TIME SEGMENT) | GEOMETRIC DELAY (VEH.MIN/ TIME SEGMENT) | AVERAGE DELAY PER ARRIVING VEHICLE (MIN) | I |
|---|-------------|---------------------|-----------------------|------------------------------|----------------------------------|--------------------------|------------------------|-------------------------------------|---|--|---|
| I | 18.00-18.15 | | | | | | | | | | I |
| I | B-CD | 0.08 | 9.02 | 0.008 | | 0.01 | 0.01 | 0.1 | | 0.11 | I |
| I | B-AD | 0.04 | 6.42 | 0.006 | | 0.01 | 0.01 | 0.1 | | 0.16 | I |
| I | A-BCD | 0.13 | 14.21 | 0.009 | | 0.01 | 0.01 | 0.2 | | 0.07 | I |
| I | A-B | 0.06 | | | | | | | | | I |
| I | A-C | 8.17 | | | | | | | | | I |
| I | D-AB | 0.01 | 8.98 | 0.001 | | 0.00 | 0.00 | 0.0 | | 0.11 | I |
| I | D-BC | 0.03 | 6.00 | 0.004 | | 0.01 | 0.00 | 0.1 | | 0.17 | I |
| I | C-ABD | 0.24 | 13.14 | 0.018 | | 0.03 | 0.02 | 0.3 | | 0.08 | I |
| I | C-D | 0.10 | | | | | | | | | I |
| I | C-A | 6.62 | | | | | | | | | I |

WARNING NO MARGINAL ANALYSIS OF CAPACITIES AS MAJOR ROAD BLOCKING MAY OCCUR

QUEUE FOR STREAM B-CD

| TIME SEGMENT ENDING | NO. OF VEHICLES IN QUEUE |
|------------------------|--------------------------------|
| 17.00 | 0.0 |
| 17.15 | 0.0 |
| 17.30 | 0.0 |
| 17.45 | 0.0 |
| 18.00 | 0.0 |
| 18.15 | 0.0 |

QUEUE FOR STREAM B-AD

| TIME SEGMENT ENDING | NO. OF VEHICLES IN QUEUE |
|------------------------|--------------------------------|
| 17.00 | 0.0 |
| 17.15 | 0.0 |
| 17.30 | 0.0 |
| 17.45 | 0.0 |
| 18.00 | 0.0 |
| 18.15 | 0.0 |

QUEUE FOR STREAM A-BCD

| TIME SEGMENT ENDING | NO. OF VEHICLES IN QUEUE |
|------------------------|--------------------------------|
| 17.00 | 0.0 |
| 17.15 | 0.0 |
| 17.30 | 0.0 |
| 17.45 | 0.0 |
| 18.00 | 0.0 |
| 18.15 | 0.0 |

QUEUE FOR STREAM D-AB

| TIME SEGMENT ENDING | NO. OF VEHICLES IN QUEUE |
|------------------------|--------------------------------|
| 17.00 | 0.0 |
| 17.15 | 0.0 |
| 17.30 | 0.0 |
| 17.45 | 0.0 |
| 18.00 | 0.0 |
| 18.15 | 0.0 |

QUEUE FOR STREAM D-BC

| TIME SEGMENT ENDING | NO. OF VEHICLES IN QUEUE |
|------------------------|--------------------------------|
| 17.00 | 0.0 |
| 17.15 | 0.0 |
| 17.30 | 0.0 |
| 17.45 | 0.0 |
| 18.00 | 0.0 |
| 18.15 | 0.0 |

QUEUE FOR STREAM C-ABD

| TIME SEGMENT ENDING | NO. OF VEHICLES IN QUEUE |
|---------------------|--------------------------|
| 17.00 | 0.0 |
| 17.15 | 0.0 |
| 17.30 | 0.0 |
| 17.45 | 0.0 |
| 18.00 | 0.0 |
| 18.15 | 0.0 |

QUEUEING DELAY INFORMATION OVER WHOLE PERIOD

| I | STREAM | I | TOTAL DEMAND | I | * QUEUEING * * DELAY * | I | * INCLUSIVE QUEUEING * * DELAY * | I | |
|---|--------|---|--------------|----------|---------------------------|-----------|-------------------------------------|-----------|---|
| I | I | I | I | I | I | I | I | I | |
| I | I | I | (VEH) | (VEH/H) | (MIN) | (MIN/VEH) | (MIN) | (MIN/VEH) | |
| I | B-CD | I | 8.3 | I 5.5 | I 1.0 | I 0.12 | I 1.0 | I 0.12 | I |
| I | B-AD | I | 4.1 | I 2.8 | I 0.8 | I 0.18 | I 0.8 | I 0.18 | I |
| I | A-BCD | I | 17.2 | I 11.5 | I 1.3 | I 0.07 | I 1.3 | I 0.07 | I |
| I | A-B | I | 6.8 | I 4.5 | I | I | I | I | I |
| I | A-C | I | 894.1 | I 596.0 | I | I | I | I | I |
| I | D-AB | I | 1.4 | I 0.9 | I 0.2 | I 0.12 | I 0.2 | I 0.12 | I |
| I | D-BC | I | 2.8 | I 1.8 | I 0.5 | I 0.19 | I 0.5 | I 0.19 | I |
| I | C-ABD | I | 31.2 | I 20.8 | I 2.9 | I 0.09 | I 2.9 | I 0.09 | I |
| I | C-D | I | 10.8 | I 7.2 | I | I | I | I | I |
| I | C-A | I | 722.0 | I 481.3 | I | I | I | I | I |
| I | ALL | I | 1698.5 | I 1132.3 | I 6.6 | I 0.00 | I 6.6 | I 0.00 | I |

* DELAY IS THAT OCCURRING ONLY WITHIN THE TIME PERIOD .

* INCLUSIVE DELAY INCLUDES DELAY SUFFERED BY VEHICLES WHICH ARE STILL QUEUEING AFTER THE END OF THE TIME PERIOD.

* THESE WILL ONLY BE SIGNIFICANTLY DIFFERENT IF THERE IS A LARGE QUEUE REMAINING AT THE END OF THE TIME PERIOD.

END OF JOB

===== end of file =====

TRL LIMITED

(C) COPYRIGHT 2006

CAPACITIES, QUEUES, AND DELAYS AT 3 OR 4-ARM MAJOR/MINOR PRIORITY JUNCTIONS

PICADY 5.0 ANALYSIS PROGRAM
RELEASE 3.0 (JUNE 2006)

ADAPTED FROM PICADY/3 WHICH IS CROWN COPYRIGHT
BY PERMISSION OF THE CONTROLLER OF HMSO

FOR SALES AND DISTRIBUTION INFORMATION,
PROGRAM ADVICE AND MAINTENANCE CONTACT:
TRL SOFTWARE BUREAU
TEL: CROWTHORNE (01344) 770758, FAX: 770864
EMAIL: SoftwareBureau@trl.co.uk

THE USER OF THIS COMPUTER PROGRAM FOR THE SOLUTION OF AN ENGINEERING PROBLEM IS
IN NO WAY RELIEVED OF HIS RESPONSIBILITY FOR THE CORRECTNESS OF THE SOLUTION

Run with file:-

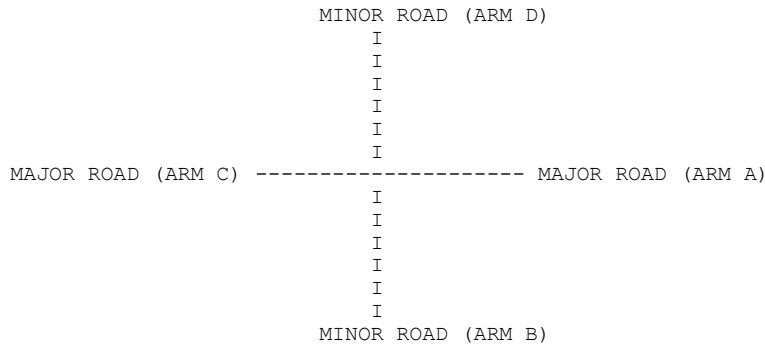
"J:\120000\120669-00\4 Internal Project Data\4-04 Calculations\4-04-06 Junction Analysis\Picady\Main Access Jct\
Main Access Junction - Camp Rd 2013 Base + Gen AM Flows.vpi"
(drive-on-the-left) at 10:07:38 on Monday, 6 August 2007

RUN INFORMATION

RUN TITLE: Main Access Junction - Camp Road 2013 Base + Gen AM Flows
LOCATION: Heyford
DATE: 02/08/07
CLIENT:
ENUMERATOR:
JOB NUMBER: 120669
STATUS:
DESCRIPTION:

.MAJOR/MINOR JUNCTION CAPACITY AND DELAY

INPUT DATA



ARM A IS Camp Road (W)
ARM B IS Main Access (N)
ARM C IS Camp Road (E)
ARM D IS New Access (S)

STREAM LABELLING CONVENTION

STREAM A-B CONTAINS TRAFFIC GOING FROM ARM A TO ARM B
STREAM B-AC CONTAINS TRAFFIC GOING FROM ARM B TO ARM A AND TO ARM C
ETC.

GEOMETRIC DATA

| DATA ITEM | MINOR ROAD B | MINOR ROAD D |
|------------------------------------|----------------|----------------|
| TOTAL MAJOR ROAD CARRIAGEWAY WIDTH | (W) 6.00 M. | (W) 6.00 M. |
| CENTRAL RESERVE WIDTH | (WCR) 0.00 M. | (WCR) 0.00 M. |
| MAJOR ROAD RIGHT TURN - WIDTH | (WC-B) 2.20 M. | (WA-D) 2.20 M. |
| - VISIBILITY | (VC-B) 58.0 M. | (VA-D) 76.0 M. |
| - BLOCKS TRAFFIC | YES | YES |
| MINOR ROAD - VISIBILITY TO LEFT | (VB-C) 33.0 M. | (VD-A) 26.0 M. |
| - VISIBILITY TO RIGHT | (VB-A) 61.0 M. | (VD-C) 37.0 M. |
| - LANE 1 WIDTH | (WB-C) - | (WD-A) - |
| - LANE 2 WIDTH | (WB-A) - | (WD-C) - |
| - WIDTH AT 0 M FROM JUNC. | 10.00 M. | 10.00 M. |
| - WIDTH AT 5 M FROM JUNC. | 3.50 M. | 3.00 M. |
| - WIDTH AT 10 M FROM JUNC. | 3.00 M. | 3.00 M. |
| - WIDTH AT 15 M FROM JUNC. | 3.00 M. | 3.00 M. |
| - WIDTH AT 20 M FROM JUNC. | 3.00 M. | 3.00 M. |
| - LENGTH OF FLARED SECTION | DERIVED: 0 PCU | DERIVED: 0 PCU |

.SLOPES AND INTERCPET

(NB:Streams may be combined, in which case capacity will be adjusted)

B-C Stream

| Intercept For Stream B-C | Slope For Opposing Stream A-C | Slope For Opposing Stream A-B |
|--------------------------|-------------------------------|-------------------------------|
| 609.29 | 0.24 | 0.09 |

D-A Stream

| Intercept For Stream D-A | Slope For Opposing Stream C-A | Slope For Opposing Stream C-D |
|--------------------------|-------------------------------|-------------------------------|
| 595.39 | 0.23 | 0.09 |

B-A Stream

| Intercept For Stream B-A | Slope For Opposing Stream A-C | Slope For Opposing Stream A-D | Slope For Opposing Stream D-A | Slope For Opposing Stream D-B |
|--------------------------|-------------------------------|-------------------------------|-------------------------------|-------------------------------|
| 476.79 | 0.22 | 0.22 | 0.22 | 0.22 |

| Slope For Opposing Stream A-B | Slope For Opposing Stream C-A | Slope For Opposing Stream C-B | Slope For Opposing Stream D-C |
|-------------------------------|-------------------------------|-------------------------------|-------------------------------|
| 0.09 | 0.14 | 0.31 | 0.11 |

D-C Stream

| Intercept For Stream D-C | Slope For Opposing Stream C-A | Slope For Opposing Stream C-B | Slope For Opposing Stream B-C | Slope For Opposing Stream B-D |
|--------------------------|-------------------------------|-------------------------------|-------------------------------|-------------------------------|
| 463.81 | 0.21 | 0.21 | 0.21 | 0.21 |

| Slope For Opposing Stream C-D | Slope For Opposing Stream A-C | Slope For Opposing Stream A-D | Slope For Opposing Stream B-A |
|-------------------------------|-------------------------------|-------------------------------|-------------------------------|
| 0.08 | 0.13 | 0.31 | 0.11 |

C-B Stream

| Intercept For Stream C-B | Slope For Opposing Stream A-C | Slope For Opposing Stream A-D |
|--------------------------|-------------------------------|-------------------------------|
| 607.55 | 0.24 | 0.34 |

A-D Stream

| I | Intercept For Stream A-D | Slope For Opposing Stream C-A | Slope For Opposing Stream C-B | I |
|---|--------------------------|-------------------------------|-------------------------------|---|
| I | 617.98 | 0.24 | 0.34 | I |

B-D Stream From Left Hand Lane

| I | Intercept For Stream B-D | Slope For Opposing Stream A-C | Slope For Opposing Stream A-D | Slope For Opposing Stream A-B | Slope For Opposing Stream C-B | I |
|---|--------------------------|-------------------------------|-------------------------------|-------------------------------|-------------------------------|---|
| I | 476.79 | 0.22 | 0.22 | 0.09 | 0.31 | I |

| I | Slope For Opposing Stream C-A | Slope For Opposing Stream C-D | Slope For Opposing Stream C-B | I |
|---|-------------------------------|-------------------------------|-------------------------------|---|
| I | 0.14 | 0.14 | | I |

B-D Stream From Right Hand Lane

| I | Intercept For Stream B-D | Slope For Opposing Stream A-C | Slope For Opposing Stream A-D | Slope For Opposing Stream A-B | Slope For Opposing Stream C-B | I |
|---|--------------------------|-------------------------------|-------------------------------|-------------------------------|-------------------------------|---|
| I | 476.79 | 0.22 | 0.22 | 0.09 | 0.31 | I |

| I | Slope For Opposing Stream C-A | Slope For Opposing Stream C-D | Slope For Opposing Stream C-B | I |
|---|-------------------------------|-------------------------------|-------------------------------|---|
| I | 0.14 | 0.14 | | I |

D-B Stream From Left Hand Lane

| I | Intercept For Stream D-B | Slope For Opposing Stream C-A | Slope For Opposing Stream C-B | Slope For Opposing Stream D-C | Slope For Opposing Stream A-D | I |
|---|--------------------------|-------------------------------|-------------------------------|-------------------------------|-------------------------------|---|
| I | 463.81 | 0.21 | 0.21 | 0.08 | 0.31 | I |

| I | Slope For Opposing Stream A-C | Slope For Opposing Stream A-B | Slope For Opposing Stream C-B | I |
|---|-------------------------------|-------------------------------|-------------------------------|---|
| I | 0.13 | 0.13 | | I |

D-B Stream From Right Hand Lane

| I | Intercept For Stream D-B | Slope For Opposing Stream C-A | Slope For Opposing Stream C-B | Slope For Opposing Stream C-D | Slope For Opposing Stream A-D | I |
|---|--------------------------|-------------------------------|-------------------------------|-------------------------------|-------------------------------|---|
| I | 463.81 | 0.21 | 0.21 | 0.08 | 0.31 | I |

| I | Slope For Opposing Stream A-C | Slope For Opposing Stream A-B | Slope For Opposing Stream C-B | I |
|---|-------------------------------|-------------------------------|-------------------------------|---|
| I | 0.13 | 0.13 | | I |

TRAFFIC DEMAND DATA

| I | TIME | DEMAND (VEH/MIN) | CAPACITY (VEH/MIN) | DEMAND/ CAPACITY (RFC) | PEDESTRIAN FLOW (PEDS/MIN) | START QUEUE (VEHS) | END QUEUE (VEHS) | DELAY (VEH.MIN/ TIME SEGMENT) | GEOMETRIC DELAY (VEH.MIN/ TIME SEGMENT) | AVERAGE DELAY PER ARRIVING VEHICLE (MIN) | I |
|---|-------------|---------------------|-----------------------|------------------------------|----------------------------------|--------------------------|------------------------|-------------------------------------|---|--|---|
| I | 09.00-09.15 | | | | | | | | | | I |
| I | B-CD | 1.07 | 9.78 | 0.110 | | 0.16 | 0.12 | 1.9 | | 0.11 | I |
| I | B-AD | 0.50 | 7.04 | 0.070 | | 0.10 | 0.08 | 1.2 | | 0.15 | I |
| I | A-BCD | 0.27 | 13.36 | 0.020 | | 0.03 | 0.02 | 0.4 | | 0.08 | I |
| I | A-B | 0.91 | | | | | | | | | I |
| I | A-C | 5.45 | | | | | | | | | I |
| I | D-AB | 0.60 | 11.16 | 0.054 | | 0.07 | 0.06 | 0.9 | | 0.09 | I |
| I | D-BC | 1.53 | 6.45 | 0.238 | | 0.45 | 0.32 | 4.9 | | 0.20 | I |
| I | C-ABD | 2.48 | 10.60 | 0.234 | | 0.58 | 0.40 | 6.1 | | 0.12 | I |
| I | C-D | 0.32 | | | | | | | | | I |
| I | C-A | 1.87 | | | | | | | | | I |
| I | | | | | | | | | | | I |

WARNING NO MARGINAL ANALYSIS OF CAPACITIES AS MAJOR ROAD BLOCKING MAY OCCUR

QUEUE FOR STREAM B-CD

| TIME SEGMENT ENDING | NO. OF VEHICLES IN QUEUE |
|------------------------|--------------------------------|
| 08.00 | 0.1 |
| 08.15 | 0.2 |
| 08.30 | 0.2 |
| 08.45 | 0.2 |
| 09.00 | 0.2 |
| 09.15 | 0.1 |

QUEUE FOR STREAM B-AD

| TIME SEGMENT ENDING | NO. OF VEHICLES IN QUEUE |
|------------------------|--------------------------------|
| 08.00 | 0.1 |
| 08.15 | 0.1 |
| 08.30 | 0.1 |
| 08.45 | 0.2 |
| 09.00 | 0.1 |
| 09.15 | 0.1 |

QUEUE FOR STREAM A-BCD

| TIME SEGMENT ENDING | NO. OF VEHICLES IN QUEUE |
|------------------------|--------------------------------|
| 08.00 | 0.0 |
| 08.15 | 0.0 |
| 08.30 | 0.0 |
| 08.45 | 0.0 |
| 09.00 | 0.0 |
| 09.15 | 0.0 |

QUEUE FOR STREAM D-AB

| TIME SEGMENT ENDING | NO. OF VEHICLES IN QUEUE |
|------------------------|--------------------------------|
| 08.00 | 0.1 |
| 08.15 | 0.1 |
| 08.30 | 0.1 |
| 08.45 | 0.1 |
| 09.00 | 0.1 |
| 09.15 | 0.1 |

QUEUE FOR STREAM D-BC

| TIME SEGMENT ENDING | NO. OF VEHICLES IN QUEUE | |
|------------------------|--------------------------------|---|
| 08.00 | 0.3 | |
| 08.15 | 0.4 | |
| 08.30 | 0.7 | * |
| 08.45 | 0.7 | * |
| 09.00 | 0.4 | |
| 09.15 | 0.3 | |

QUEUE FOR STREAM C-ABD

| TIME SEGMENT ENDING | NO. OF VEHICLES IN QUEUE | |
|---------------------|--------------------------|---|
| 08.00 | 0.4 | |
| 08.15 | 0.6 | * |
| 08.30 | 0.9 | * |
| 08.45 | 0.9 | * |
| 09.00 | 0.6 | * |
| 09.15 | 0.4 | |

QUEUEING DELAY INFORMATION OVER WHOLE PERIOD

| I | STREAM | I | TOTAL DEMAND | I | * QUEUEING * * DELAY * | I | * INCLUSIVE QUEUEING * * DELAY * | I |
|---|--------|---|--------------|----------|---------------------------|-----------|-------------------------------------|-----------|
| I | I | I | I | I | I | I | I | I |
| I | I | I | (VEH) | (VEH/H) | (MIN) | (MIN/VEH) | (MIN) | (MIN/VEH) |
| I | B-CD | I | 117.8 | I 78.5 | I 14.7 | I 0.12 | I 14.7 | I 0.12 |
| I | B-AD | I | 54.3 | I 36.2 | I 9.7 | I 0.18 | I 9.7 | I 0.18 |
| I | A-BCD | I | 34.4 | I 22.9 | I 3.1 | I 0.09 | I 3.1 | I 0.09 |
| I | A-B | I | 99.3 | I 66.2 | I | I | I | I |
| I | A-C | I | 594.4 | I 396.3 | I | I | I | I |
| I | D-AB | I | 66.1 | I 44.0 | I 6.6 | I 0.10 | I 6.6 | I 0.10 |
| I | D-BC | I | 167.9 | I 111.9 | I 42.6 | I 0.25 | I 42.6 | I 0.25 |
| I | C-ABD | I | 298.3 | I 198.9 | I 55.9 | I 0.19 | I 55.9 | I 0.19 |
| I | C-D | I | 30.9 | I 20.6 | I | I | I | I |
| I | C-A | I | 182.8 | I 121.9 | I | I | I | I |
| I | ALL | I | 1646.2 | I 1097.5 | I 132.7 | I 0.08 | I 132.7 | I 0.08 |

* DELAY IS THAT OCCURRING ONLY WITHIN THE TIME PERIOD .
 * INCLUSIVE DELAY INCLUDES DELAY SUFFERED BY VEHICLES WHICH ARE STILL QUEUEING AFTER THE END OF THE TIME PERIOD.
 * THESE WILL ONLY BE SIGNIFICANTLY DIFFERENT IF THERE IS A LARGE QUEUE REMAINING AT THE END OF THE TIME PERIOD.

END OF JOB

===== end of file =====

TRL LIMITED

(C) COPYRIGHT 2006

CAPACITIES, QUEUES, AND DELAYS AT 3 OR 4-ARM MAJOR/MINOR PRIORITY JUNCTIONS

PICADY 5.0 ANALYSIS PROGRAM
RELEASE 3.0 (JUNE 2006)

ADAPTED FROM PICADY/3 WHICH IS CROWN COPYRIGHT
BY PERMISSION OF THE CONTROLLER OF HMSO

FOR SALES AND DISTRIBUTION INFORMATION,
PROGRAM ADVICE AND MAINTENANCE CONTACT:
TRL SOFTWARE BUREAU
TEL: CROWTHORNE (01344) 770758, FAX: 770864
EMAIL: SoftwareBureau@trl.co.uk

THE USER OF THIS COMPUTER PROGRAM FOR THE SOLUTION OF AN ENGINEERING PROBLEM IS
IN NO WAY RELIEVED OF HIS RESPONSIBILITY FOR THE CORRECTNESS OF THE SOLUTION

Run with file:-

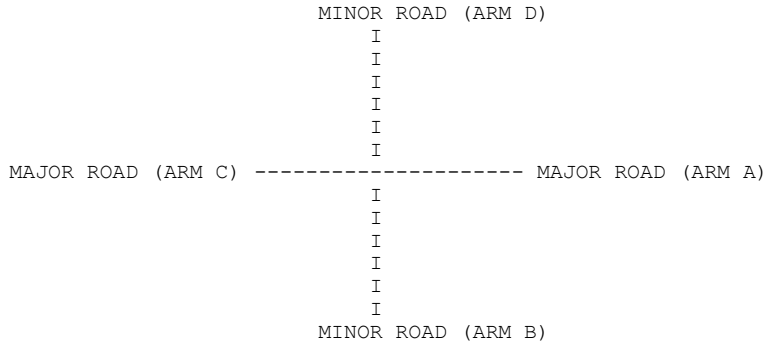
"J:\120000\120669-00\4 Internal Project Data\4-04 Calculations\4-04-06 Junction Analysis\Picady\Main Access Jct\
Main Access Junction - Camp Rd 2013 Base + Gen PM Flows.vpi"
(drive-on-the-left) at 10:07:55 on Monday, 6 August 2007

RUN INFORMATION

RUN TITLE: Main Access Junction - Camp Road 2013 Base + Gen PM Flows
LOCATION: Heyford
DATE: 02/08/07
CLIENT:
ENUMERATOR:
JOB NUMBER: 120669
STATUS:
DESCRIPTION:

.MAJOR/MINOR JUNCTION CAPACITY AND DELAY

INPUT DATA



ARM A IS Camp Road (W)
ARM B IS Main Access (N)
ARM C IS Camp Road (E)
ARM D IS New Access (S)

STREAM LABELLING CONVENTION

STREAM A-B CONTAINS TRAFFIC GOING FROM ARM A TO ARM B
STREAM B-AC CONTAINS TRAFFIC GOING FROM ARM B TO ARM A AND TO ARM C
ETC.

GEOMETRIC DATA

| DATA ITEM | MINOR ROAD B | MINOR ROAD D |
|------------------------------------|----------------|----------------|
| TOTAL MAJOR ROAD CARRIAGEWAY WIDTH | (W) 6.00 M. | (W) 6.00 M. |
| CENTRAL RESERVE WIDTH | (WCR) 0.00 M. | (WCR) 0.00 M. |
| MAJOR ROAD RIGHT TURN - WIDTH | (WC-B) 2.20 M. | (WA-D) 2.20 M. |
| - VISIBILITY | (VC-B) 58.0 M. | (VA-D) 76.0 M. |
| - BLOCKS TRAFFIC | YES | YES |
| MINOR ROAD - VISIBILITY TO LEFT | (VB-C) 33.0 M. | (VD-A) 26.0 M. |
| - VISIBILITY TO RIGHT | (VB-A) 61.0 M. | (VD-C) 37.0 M. |
| - LANE 1 WIDTH | (WB-C) - | (WD-A) - |
| - LANE 2 WIDTH | (WB-A) - | (WD-C) - |
| - WIDTH AT 0 M FROM JUNC. | 10.00 M. | 10.00 M. |
| - WIDTH AT 5 M FROM JUNC. | 3.50 M. | 3.00 M. |
| - WIDTH AT 10 M FROM JUNC. | 3.00 M. | 3.00 M. |
| - WIDTH AT 15 M FROM JUNC. | 3.00 M. | 3.00 M. |
| - WIDTH AT 20 M FROM JUNC. | 3.00 M. | 3.00 M. |
| - LENGTH OF FLARED SECTION | DERIVED: 0 PCU | DERIVED: 0 PCU |

.SLOPES AND INTERCPET

(NB:Streams may be combined, in which case capacity will be adjusted)

B-C Stream

| Intercept For Stream B-C | Slope For Opposing Stream A-C | Slope For Opposing Stream A-B |
|--------------------------|-------------------------------|-------------------------------|
| 609.29 | 0.24 | 0.09 |

D-A Stream

| Intercept For Stream D-A | Slope For Opposing Stream C-A | Slope For Opposing Stream C-D |
|--------------------------|-------------------------------|-------------------------------|
| 595.39 | 0.23 | 0.09 |

B-A Stream

| Intercept For Stream B-A | Slope For Opposing Stream A-C | Slope For Opposing Stream A-D | Slope For Opposing Stream D-A | Slope For Opposing Stream D-B |
|--------------------------|-------------------------------|-------------------------------|-------------------------------|-------------------------------|
| 476.79 | 0.22 | 0.22 | 0.22 | 0.22 |

| Slope For Opposing Stream A-B | Slope For Opposing Stream C-A | Slope For Opposing Stream C-B | Slope For Opposing Stream D-C |
|-------------------------------|-------------------------------|-------------------------------|-------------------------------|
| 0.09 | 0.14 | 0.31 | 0.11 |

D-C Stream

| Intercept For Stream D-C | Slope For Opposing Stream C-A | Slope For Opposing Stream C-B | Slope For Opposing Stream B-C | Slope For Opposing Stream B-D |
|--------------------------|-------------------------------|-------------------------------|-------------------------------|-------------------------------|
| 463.81 | 0.21 | 0.21 | 0.21 | 0.21 |

| Slope For Opposing Stream C-D | Slope For Opposing Stream A-C | Slope For Opposing Stream A-D | Slope For Opposing Stream B-A |
|-------------------------------|-------------------------------|-------------------------------|-------------------------------|
| 0.08 | 0.13 | 0.31 | 0.11 |

C-B Stream

| Intercept For Stream C-B | Slope For Opposing Stream A-C | Slope For Opposing Stream A-D |
|--------------------------|-------------------------------|-------------------------------|
| 607.55 | 0.24 | 0.34 |

A-D Stream

| I | Intercept For Stream A-D | Slope For Opposing Stream C-A | Slope For Opposing Stream C-B | I |
|---|--------------------------|-------------------------------|-------------------------------|---|
| I | 617.98 | 0.24 | 0.34 | I |

B-D Stream From Left Hand Lane

| I | Intercept For Stream B-D | Slope For Opposing Stream A-C | Slope For Opposing Stream A-D | Slope For Opposing Stream A-B | Slope For Opposing Stream C-B | I |
|---|--------------------------|-------------------------------|-------------------------------|-------------------------------|-------------------------------|---|
| I | 476.79 | 0.22 | 0.22 | 0.09 | 0.31 | I |

| I | Slope For Opposing Stream C-A | Slope For Opposing Stream C-D | Slope For Opposing Stream C-B | I |
|---|-------------------------------|-------------------------------|-------------------------------|---|
| I | 0.14 | 0.14 | | I |

B-D Stream From Right Hand Lane

| I | Intercept For Stream B-D | Slope For Opposing Stream A-C | Slope For Opposing Stream A-D | Slope For Opposing Stream A-B | Slope For Opposing Stream C-B | I |
|---|--------------------------|-------------------------------|-------------------------------|-------------------------------|-------------------------------|---|
| I | 476.79 | 0.22 | 0.22 | 0.09 | 0.31 | I |

| I | Slope For Opposing Stream C-A | Slope For Opposing Stream C-D | Slope For Opposing Stream C-B | I |
|---|-------------------------------|-------------------------------|-------------------------------|---|
| I | 0.14 | 0.14 | | I |

D-B Stream From Left Hand Lane

| I | Intercept For Stream D-B | Slope For Opposing Stream C-A | Slope For Opposing Stream C-B | Slope For Opposing Stream D-C | Slope For Opposing Stream A-D | I |
|---|--------------------------|-------------------------------|-------------------------------|-------------------------------|-------------------------------|---|
| I | 463.81 | 0.21 | 0.21 | 0.08 | 0.31 | I |

| I | Slope For Opposing Stream A-C | Slope For Opposing Stream A-B | Slope For Opposing Stream C-B | I |
|---|-------------------------------|-------------------------------|-------------------------------|---|
| I | 0.13 | 0.13 | | I |

D-B Stream From Right Hand Lane

| I | Intercept For Stream D-B | Slope For Opposing Stream C-A | Slope For Opposing Stream C-B | Slope For Opposing Stream C-D | Slope For Opposing Stream A-D | I |
|---|--------------------------|-------------------------------|-------------------------------|-------------------------------|-------------------------------|---|
| I | 463.81 | 0.21 | 0.21 | 0.08 | 0.31 | I |

| I | Slope For Opposing Stream A-C | Slope For Opposing Stream A-B | Slope For Opposing Stream C-B | I |
|---|-------------------------------|-------------------------------|-------------------------------|---|
| I | 0.13 | 0.13 | | I |

TRAFFIC DEMAND DATA

| I | TIME | DEMAND (VEH/MIN) | CAPACITY (VEH/MIN) | DEMAND/ CAPACITY (RFC) | PEDESTRIAN FLOW (PEDS/MIN) | START QUEUE (VEHS) | END QUEUE (VEHS) | DELAY (VEH.MIN/ TIME SEGMENT) | GEOMETRIC DELAY (VEH.MIN/ TIME SEGMENT) | AVERAGE DELAY PER ARRIVING VEHICLE (MIN) | I |
|---|-------------|---------------------|-----------------------|------------------------------|----------------------------------|--------------------------|------------------------|-------------------------------------|---|--|---|
| I | 18.00-18.15 | | | | | | | | | | I |
| I | B-CD | 1.76 | 10.35 | 0.170 | | 0.27 | 0.21 | 3.2 | | 0.12 | I |
| I | B-AD | 0.90 | 7.85 | 0.115 | | 0.17 | 0.13 | 2.0 | | 0.14 | I |
| I | A-BCD | 0.68 | 11.05 | 0.061 | | 0.15 | 0.10 | 1.5 | | 0.10 | I |
| I | A-B | 0.45 | | | | | | | | | I |
| I | A-C | 2.90 | | | | | | | | | I |
| I | D-AB | 0.27 | 10.91 | 0.025 | | 0.03 | 0.03 | 0.4 | | 0.09 | I |
| I | D-BC | 0.71 | 6.08 | 0.117 | | 0.18 | 0.13 | 2.1 | | 0.19 | I |
| I | C-ABD | 1.81 | 13.22 | 0.137 | | 0.40 | 0.28 | 4.2 | | 0.09 | I |
| I | C-D | 1.07 | | | | | | | | | I |
| I | C-A | 4.03 | | | | | | | | | I |
| I | | | | | | | | | | | I |

WARNING NO MARGINAL ANALYSIS OF CAPACITIES AS MAJOR ROAD BLOCKING MAY OCCUR

QUEUE FOR STREAM B-CD

| TIME SEGMENT ENDING | NO. OF VEHICLES IN QUEUE |
|------------------------|--------------------------------|
| 17.00 | 0.2 |
| 17.15 | 0.3 |
| 17.30 | 0.4 |
| 17.45 | 0.4 |
| 18.00 | 0.3 |
| 18.15 | 0.2 |

QUEUE FOR STREAM B-AD

| TIME SEGMENT ENDING | NO. OF VEHICLES IN QUEUE |
|------------------------|--------------------------------|
| 17.00 | 0.1 |
| 17.15 | 0.2 |
| 17.30 | 0.2 |
| 17.45 | 0.2 |
| 18.00 | 0.2 |
| 18.15 | 0.1 |

QUEUE FOR STREAM A-BCD

| TIME SEGMENT ENDING | NO. OF VEHICLES IN QUEUE |
|------------------------|--------------------------------|
| 17.00 | 0.1 |
| 17.15 | 0.1 |
| 17.30 | 0.2 |
| 17.45 | 0.2 |
| 18.00 | 0.1 |
| 18.15 | 0.1 |

QUEUE FOR STREAM D-AB

| TIME SEGMENT ENDING | NO. OF VEHICLES IN QUEUE |
|------------------------|--------------------------------|
| 17.00 | 0.0 |
| 17.15 | 0.0 |
| 17.30 | 0.0 |
| 17.45 | 0.0 |
| 18.00 | 0.0 |
| 18.15 | 0.0 |

QUEUE FOR STREAM D-BC

| TIME SEGMENT ENDING | NO. OF VEHICLES IN QUEUE |
|------------------------|--------------------------------|
| 17.00 | 0.1 |
| 17.15 | 0.2 |
| 17.30 | 0.3 |
| 17.45 | 0.3 |
| 18.00 | 0.2 |
| 18.15 | 0.1 |

QUEUE FOR STREAM C-ABD

| TIME SEGMENT ENDING | NO. OF VEHICLES IN QUEUE |
|---------------------|--------------------------|
| 17.00 | 0.3 |
| 17.15 | 0.4 |
| 17.30 | 0.6 * |
| 17.45 | 0.6 * |
| 18.00 | 0.4 |
| 18.15 | 0.3 |

QUEUEING DELAY INFORMATION OVER WHOLE PERIOD

| I | STREAM | I | TOTAL DEMAND | I | * QUEUEING * | I | * INCLUSIVE QUEUEING * | I | | |
|---|--------|---|--------------|---------|--------------|-----------|------------------------|-----------|------|---|
| I | I | I | I | I | * DELAY * | I | * DELAY * | I | | |
| I | I | I | (VEH) | (VEH/H) | (MIN) | (MIN/VEH) | (MIN) | (MIN/VEH) | | |
| I | B-CD | I | 192.9 | I | 128.6 | I | 24.5 | I | 0.13 | I |
| I | B-AD | I | 98.9 | I | 65.9 | I | 16.2 | I | 0.16 | I |
| I | A-BCD | I | 83.3 | I | 55.5 | I | 14.0 | I | 0.17 | I |
| I | A-B | I | 48.0 | I | 32.0 | I | | I | | I |
| I | A-C | I | 310.6 | I | 207.0 | I | | I | | I |
| I | D-AB | I | 29.7 | I | 19.8 | I | 2.9 | I | 0.10 | I |
| I | D-BC | I | 77.7 | I | 51.8 | I | 17.2 | I | 0.22 | I |
| I | C-ABD | I | 231.8 | I | 154.5 | I | 38.1 | I | 0.16 | I |
| I | C-D | I | 110.7 | I | 73.8 | I | | I | | I |
| I | C-A | I | 415.9 | I | 277.3 | I | | I | | I |
| I | ALL | I | 1599.4 | I | 1066.3 | I | 112.9 | I | 0.07 | I |

* DELAY IS THAT OCCURRING ONLY WITHIN THE TIME PERIOD .
 * INCLUSIVE DELAY INCLUDES DELAY SUFFERED BY VEHICLES WHICH ARE STILL QUEUEING AFTER THE END OF THE TIME PERIOD.
 * THESE WILL ONLY BE SIGNIFICANTLY DIFFERENT IF THERE IS A LARGE QUEUE REMAINING AT THE END OF THE TIME PERIOD.

END OF JOB

==== end of file =====

TRL LIMITED

(C) COPYRIGHT 2006

CAPACITIES, QUEUES, AND DELAYS AT 3 OR 4-ARM MAJOR/MINOR PRIORITY JUNCTIONS

PICADY 5.0 ANALYSIS PROGRAM
RELEASE 3.0 (JUNE 2006)

ADAPTED FROM PICADY/3 WHICH IS CROWN COPYRIGHT
BY PERMISSION OF THE CONTROLLER OF HMSO

FOR SALES AND DISTRIBUTION INFORMATION,
PROGRAM ADVICE AND MAINTENANCE CONTACT:
TRL SOFTWARE BUREAU
TEL: CROWTHORNE (01344) 770758, FAX: 770864
EMAIL: SoftwareBureau@trl.co.uk

THE USER OF THIS COMPUTER PROGRAM FOR THE SOLUTION OF AN ENGINEERING PROBLEM IS
IN NO WAY RELIEVED OF HIS RESPONSIBILITY FOR THE CORRECTNESS OF THE SOLUTION

Run with file:-

"J:\120000\120669-00\4 Internal Project Data\4-04 Calculations\4-04-06 Junction Analysis\Picady\Main Access Jct\
Alternative Priority - Main Access - Camp Rd 2013 Base + Gen AM Flows.vpi"
(drive-on-the-left) at 14:46:51 on Thursday, 2 August 2007

RUN INFORMATION

RUN TITLE: Alternative Priority - Main Access _ Camp Road 2013 Base + Gen AM Flows

LOCATION: Heyford

DATE: 02/08/07

CLIENT:

ENUMERATOR: chris.morris [MCCPCCP0022J]

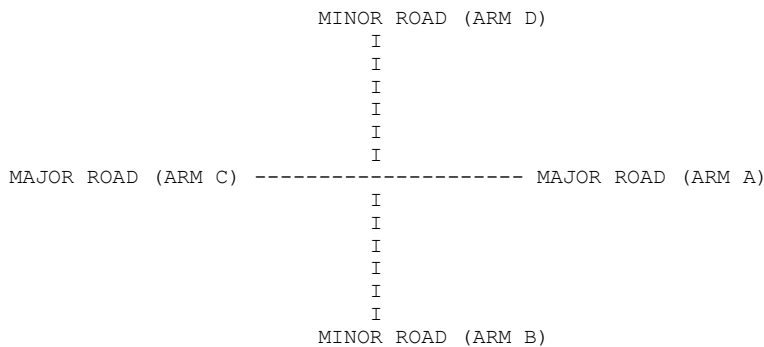
JOB NUMBER: 120699

STATUS:

DESCRIPTION:

.MAJOR/MINOR JUNCTION CAPACITY AND DELAY

INPUT DATA



- ARM A IS New Access (S)
- ARM B IS Camp Road (W)
- ARM C IS Main Access (N)
- ARM D IS Camp Road (E)

STREAM LABELLING CONVENTION

STREAM A-B CONTAINS TRAFFIC GOING FROM ARM A TO ARM B
STREAM B-AC CONTAINS TRAFFIC GOING FROM ARM B TO ARM A AND TO ARM C
ETC.

GEOMETRIC DATA

| DATA ITEM | MINOR ROAD B | MINOR ROAD D |
|------------------------------------|----------------|----------------|
| TOTAL MAJOR ROAD CARRIAGEWAY WIDTH | (W) 6.00 M. | (W) 6.00 M. |
| CENTRAL RESERVE WIDTH | (WCR) 0.00 M. | (WCR) 0.00 M. |
| MAJOR ROAD RIGHT TURN - WIDTH | (WC-B) 2.20 M. | (WA-D) 2.20 M. |
| - VISIBILITY | (VC-B) 37.0 M. | (VA-D) 67.0 M. |
| - BLOCKS TRAFFIC | YES | YES |
| MINOR ROAD - VISIBILITY TO LEFT | (VB-C) 71.0 M. | (VD-A) 27.0 M. |
| - VISIBILITY TO RIGHT | (VB-A) 18.0 M. | (VD-C) 44.0 M. |
| - LANE 1 WIDTH | (WB-C) - | (WD-A) - |
| - LANE 2 WIDTH | (WB-A) - | (WD-C) - |
| - WIDTH AT 0 M FROM JUNC. | 10.00 M. | 10.00 M. |
| - WIDTH AT 5 M FROM JUNC. | 4.00 M. | 4.00 M. |
| - WIDTH AT 10 M FROM JUNC. | 3.00 M. | 3.00 M. |
| - WIDTH AT 15 M FROM JUNC. | 3.00 M. | 3.00 M. |
| - WIDTH AT 20 M FROM JUNC. | 3.00 M. | 3.00 M. |
| - LENGTH OF FLARED SECTION | DERIVED: 0 PCU | DERIVED: 0 PCU |

.SLOPES AND INTERCPET

(NB:Streams may be combined, in which case capacity will be adjusted)

B-C Stream

| Intercept For Stream B-C | Slope For Opposing Stream A-C | Slope For Opposing Stream A-B |
|--------------------------|-------------------------------|-------------------------------|
| 584.39 | 0.23 | 0.09 |

D-A Stream

| Intercept For Stream D-A | Slope For Opposing Stream C-A | Slope For Opposing Stream C-D |
|--------------------------|-------------------------------|-------------------------------|
| 599.44 | 0.23 | 0.09 |

B-A Stream

| Intercept For Stream B-A | Slope For Opposing Stream A-C | Slope For Opposing Stream A-D | Slope For Opposing Stream D-A | Slope For Opposing Stream D-B |
|-------------------------------|-------------------------------|-------------------------------|-------------------------------|-------------------------------|
| 468.51 | 0.22 | 0.22 | 0.22 | 0.22 |
| Slope For Opposing Stream A-B | Slope For Opposing Stream C-A | Slope For Opposing Stream C-B | Slope For Opposing Stream D-C | |
| 0.09 | 0.14 | 0.31 | 0.11 | |

D-C Stream

| Intercept For Stream D-C | Slope For Opposing Stream C-A | Slope For Opposing Stream C-B | Slope For Opposing Stream B-C | Slope For Opposing Stream B-D |
|-------------------------------|-------------------------------|-------------------------------|-------------------------------|-------------------------------|
| 467.27 | 0.22 | 0.22 | 0.22 | 0.22 |
| Slope For Opposing Stream C-D | Slope For Opposing Stream A-C | Slope For Opposing Stream A-D | Slope For Opposing Stream B-A | |
| 0.09 | 0.14 | 0.31 | 0.11 | |

C-B Stream

| Intercept For Stream C-B | Slope For Opposing Stream A-C | Slope For Opposing Stream A-D |
|--------------------------|-------------------------------|-------------------------------|
| 595.39 | 0.23 | 0.33 |

A-D Stream

| I | Intercept For Stream A-D | Slope For Opposing Stream C-A | Slope For Opposing Stream C-B | I |
|---|--------------------------|-------------------------------|-------------------------------|---|
| I | 612.76 | 0.23 | 0.34 | I |

B-D Stream From Left Hand Lane

| I | Intercept For Stream B-D | Slope For Opposing Stream A-C | Slope For Opposing Stream A-D | Slope For Opposing Stream A-B | Slope For Opposing Stream C-B | I |
|---|--------------------------|-------------------------------|-------------------------------|-------------------------------|-------------------------------|---|
| I | 468.51 | 0.22 | 0.22 | 0.09 | 0.31 | I |

| I | Slope For Opposing Stream C-A | Slope For Opposing Stream C-D | Slope For Opposing Stream C-B | I |
|---|-------------------------------|-------------------------------|-------------------------------|---|
| I | 0.14 | 0.14 | | I |

B-D Stream From Right Hand Lane

| I | Intercept For Stream B-D | Slope For Opposing Stream A-C | Slope For Opposing Stream A-D | Slope For Opposing Stream A-B | Slope For Opposing Stream C-B | I |
|---|--------------------------|-------------------------------|-------------------------------|-------------------------------|-------------------------------|---|
| I | 468.51 | 0.22 | 0.22 | 0.09 | 0.31 | I |

| I | Slope For Opposing Stream C-A | Slope For Opposing Stream C-D | Slope For Opposing Stream C-B | I |
|---|-------------------------------|-------------------------------|-------------------------------|---|
| I | 0.14 | 0.14 | | I |

D-B Stream From Left Hand Lane

| I | Intercept For Stream D-B | Slope For Opposing Stream C-A | Slope For Opposing Stream C-B | Slope For Opposing Stream D-C | Slope For Opposing Stream A-D | I |
|---|--------------------------|-------------------------------|-------------------------------|-------------------------------|-------------------------------|---|
| I | 467.27 | 0.22 | 0.22 | 0.09 | 0.31 | I |

| I | Slope For Opposing Stream A-C | Slope For Opposing Stream A-B | Slope For Opposing Stream C-B | I |
|---|-------------------------------|-------------------------------|-------------------------------|---|
| I | 0.14 | 0.14 | | I |

D-B Stream From Right Hand Lane

| I | Intercept For Stream D-B | Slope For Opposing Stream C-A | Slope For Opposing Stream C-B | Slope For Opposing Stream C-D | Slope For Opposing Stream A-D | I |
|---|--------------------------|-------------------------------|-------------------------------|-------------------------------|-------------------------------|---|
| I | 467.27 | 0.22 | 0.22 | 0.09 | 0.31 | I |

| I | Slope For Opposing Stream A-C | Slope For Opposing Stream A-B | Slope For Opposing Stream C-B | I |
|---|-------------------------------|-------------------------------|-------------------------------|---|
| I | 0.14 | 0.14 | | I |

TRAFFIC DEMAND DATA

| I | TIME | DEMAND (VEH/MIN) | CAPACITY (VEH/MIN) | DEMAND/ CAPACITY (RFC) | PEDESTRIAN FLOW (PEDS/MIN) | START QUEUE (VEHS) | END QUEUE (VEHS) | DELAY (VEH.MIN/ TIME SEGMENT) | GEOMETRIC DELAY (VEH.MIN/ TIME SEGMENT) | AVERAGE DELAY PER ARRIVING VEHICLE (MIN) | I |
|---|-------------|---------------------|-----------------------|------------------------------|----------------------------------|--------------------------|------------------------|-------------------------------------|---|--|---|
| I | 09.00-09.15 | | | | | | | | | | I |
| I | B-CD | 3.76 | 8.08 | 0.465 | | 1.42 | 0.89 | 14.2 | | 0.24 | I |
| I | B-AD | 2.88 | 9.24 | 0.312 | | 0.62 | 0.46 | 7.1 | | 0.16 | I |
| I | A-BCD | 1.62 | 10.20 | 0.158 | | 0.26 | 0.20 | 3.0 | | 0.12 | I |
| I | A-B | 0.49 | | | | | | | | | I |
| I | A-C | 0.03 | | | | | | | | | I |
| I | D-AB | 1.98 | 8.80 | 0.225 | | 0.43 | 0.29 | 4.6 | | 0.15 | I |
| I | D-BC | 2.68 | 6.97 | 0.385 | | 0.93 | 0.64 | 10.1 | | 0.24 | I |
| I | C-ABD | 0.55 | 10.02 | 0.055 | | 0.09 | 0.07 | 1.0 | | 0.11 | I |
| I | C-D | 1.01 | | | | | | | | | I |
| I | C-A | 0.01 | | | | | | | | | I |

WARNING NO MARGINAL ANALYSIS OF CAPACITIES AS MAJOR ROAD BLOCKING MAY OCCUR

QUEUE FOR STREAM B-CD

| TIME SEGMENT ENDING | NO. OF VEHICLES IN QUEUE | |
|------------------------|--------------------------------|-----|
| 08.00 | 0.8 | * |
| 08.15 | 1.3 | * |
| 08.30 | 2.6 | *** |
| 08.45 | 2.8 | *** |
| 09.00 | 1.4 | * |
| 09.15 | 0.9 | * |

QUEUE FOR STREAM B-AD

| TIME SEGMENT ENDING | NO. OF VEHICLES IN QUEUE | |
|------------------------|--------------------------------|---|
| 08.00 | 0.4 | |
| 08.15 | 0.6 | * |
| 08.30 | 0.9 | * |
| 08.45 | 0.9 | * |
| 09.00 | 0.6 | * |
| 09.15 | 0.5 | |

QUEUE FOR STREAM A-BCD

| TIME SEGMENT ENDING | NO. OF VEHICLES IN QUEUE | |
|------------------------|--------------------------------|--|
| 08.00 | 0.2 | |
| 08.15 | 0.2 | |
| 08.30 | 0.3 | |
| 08.45 | 0.3 | |
| 09.00 | 0.3 | |
| 09.15 | 0.2 | |

QUEUE FOR STREAM D-AB

| TIME SEGMENT ENDING | NO. OF VEHICLES IN QUEUE | |
|------------------------|--------------------------------|---|
| 08.00 | 0.3 | |
| 08.15 | 0.4 | |
| 08.30 | 0.7 | * |
| 08.45 | 0.7 | * |
| 09.00 | 0.4 | |
| 09.15 | 0.3 | |

QUEUE FOR STREAM D-BC

| TIME SEGMENT ENDING | NO. OF VEHICLES IN QUEUE | |
|------------------------|--------------------------------|---|
| 08.00 | 0.6 | * |
| 08.15 | 0.9 | * |
| 08.30 | 1.4 | * |
| 08.45 | 1.5 | * |
| 09.00 | 0.9 | * |
| 09.15 | 0.6 | * |

QUEUE FOR STREAM C-ABD

| TIME SEGMENT ENDING | NO. OF VEHICLES IN QUEUE |
|---------------------|--------------------------|
| 08.00 | 0.1 |
| 08.15 | 0.1 |
| 08.30 | 0.1 |
| 08.45 | 0.1 |
| 09.00 | 0.1 |
| 09.15 | 0.1 |

QUEUEING DELAY INFORMATION OVER WHOLE PERIOD

| I | STREAM | I | TOTAL DEMAND | I | * QUEUEING * | I | * INCLUSIVE QUEUEING * | I | | |
|---|--------|---|--------------|---|--------------|---|------------------------|---|------|---|
| I | I | I | I | I | * DELAY * | I | * DELAY * | I | | |
| I | I | I | (VEH) | I | (MIN) | I | (MIN) | I | | |
| I | I | I | (VEH/H) | I | (MIN/VEH) | I | (MIN/VEH) | I | | |
| I | B-CD | I | 414.1 | I | 276.0 | I | 142.3 | I | 0.34 | I |
| I | B-AD | I | 314.1 | I | 209.4 | I | 57.6 | I | 0.18 | I |
| I | A-BCD | I | 180.1 | I | 120.1 | I | 23.6 | I | 0.13 | I |
| I | A-B | I | 50.6 | I | 33.7 | I | | I | | I |
| I | A-C | I | 3.3 | I | 2.2 | I | | I | | I |
| I | D-AB | I | 232.6 | I | 155.1 | I | 42.0 | I | 0.18 | I |
| I | D-BC | I | 279.5 | I | 186.3 | I | 87.6 | I | 0.31 | I |
| I | C-ABD | I | 61.9 | I | 41.3 | I | 8.0 | I | 0.13 | I |
| I | C-D | I | 108.8 | I | 72.6 | I | | I | | I |
| I | C-A | I | 1.3 | I | 0.9 | I | | I | | I |
| I | ALL | I | 1646.2 | I | 1097.5 | I | 361.0 | I | 0.22 | I |

* DELAY IS THAT OCCURRING ONLY WITHIN THE TIME PERIOD .

* INCLUSIVE DELAY INCLUDES DELAY SUFFERED BY VEHICLES WHICH ARE STILL QUEUEING AFTER THE END OF THE TIME PERIOD.

* THESE WILL ONLY BE SIGNIFICANTLY DIFFERENT IF THERE IS A LARGE QUEUE REMAINING AT THE END OF THE TIME PERIOD.

END OF JOB

===== end of file =====

TRL LIMITED

(C) COPYRIGHT 2006

CAPACITIES, QUEUES, AND DELAYS AT 3 OR 4-ARM MAJOR/MINOR PRIORITY JUNCTIONS

PICADY 5.0 ANALYSIS PROGRAM
RELEASE 3.0 (JUNE 2006)

ADAPTED FROM PICADY/3 WHICH IS CROWN COPYRIGHT
BY PERMISSION OF THE CONTROLLER OF HMSO

FOR SALES AND DISTRIBUTION INFORMATION,
PROGRAM ADVICE AND MAINTENANCE CONTACT:
TRL SOFTWARE BUREAU
TEL: CROWTHORNE (01344) 770758, FAX: 770864
EMAIL: SoftwareBureau@trl.co.uk

THE USER OF THIS COMPUTER PROGRAM FOR THE SOLUTION OF AN ENGINEERING PROBLEM IS
IN NO WAY RELIEVED OF HIS RESPONSIBILITY FOR THE CORRECTNESS OF THE SOLUTION

Run with file:-

"J:\120000\120669-00\4 Internal Project Data\4-04 Calculations\4-04-06 Junction Analysis\Picady\Main Access Jct\
Alternative Priority - Main Access - Camp Rd 2013 Base + Gen PM Flows.vpi"
(drive-on-the-left) at 10:10:02 on Monday, 6 August 2007

RUN INFORMATION

RUN TITLE: Alternative Priority - Main Access _ Camp Road 2013 Base + Gen PM Flows

LOCATION: Heyford

DATE: 02/08/07

CLIENT:

ENUMERATOR: chris.morris [MCCPCCP0022J]

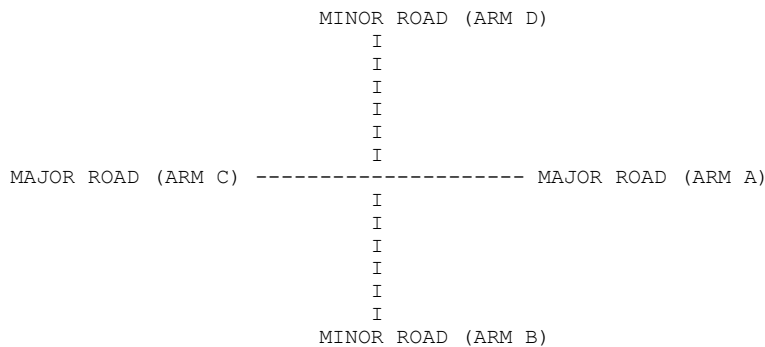
JOB NUMBER: 120699

STATUS:

DESCRIPTION:

.MAJOR/MINOR JUNCTION CAPACITY AND DELAY

INPUT DATA



- ARM A IS New Access (S)
- ARM B IS Camp Road (W)
- ARM C IS Main Access (N)
- ARM D IS Camp Road (E)

STREAM LABELLING CONVENTION

- STREAM A-B CONTAINS TRAFFIC GOING FROM ARM A TO ARM B
- STREAM B-AC CONTAINS TRAFFIC GOING FROM ARM B TO ARM A AND TO ARM C
- ETC.

GEOMETRIC DATA

| DATA ITEM | MINOR ROAD B | MINOR ROAD D |
|------------------------------------|----------------|----------------|
| TOTAL MAJOR ROAD CARRIAGEWAY WIDTH | (W) 6.00 M. | (W) 6.00 M. |
| CENTRAL RESERVE WIDTH | (WCR) 0.00 M. | (WCR) 0.00 M. |
| MAJOR ROAD RIGHT TURN - WIDTH | (WC-B) 2.20 M. | (WA-D) 2.20 M. |
| - VISIBILITY | (VC-B) 37.0 M. | (VA-D) 67.0 M. |
| - BLOCKS TRAFFIC | YES | YES |
| MINOR ROAD - VISIBILITY TO LEFT | (VB-C) 71.0 M. | (VD-A) 27.0 M. |
| - VISIBILITY TO RIGHT | (VB-A) 18.0 M. | (VD-C) 44.0 M. |
| - LANE 1 WIDTH | (WB-C) - | (WD-A) - |
| - LANE 2 WIDTH | (WB-A) - | (WD-C) - |
| - WIDTH AT 0 M FROM JUNC. | 10.00 M. | 10.00 M. |
| - WIDTH AT 5 M FROM JUNC. | 4.00 M. | 4.00 M. |
| - WIDTH AT 10 M FROM JUNC. | 3.00 M. | 3.00 M. |
| - WIDTH AT 15 M FROM JUNC. | 3.00 M. | 3.00 M. |
| - WIDTH AT 20 M FROM JUNC. | 3.00 M. | 3.00 M. |
| - LENGTH OF FLARED SECTION | DERIVED: 0 PCU | DERIVED: 0 PCU |

.SLOPES AND INTERCPET

(NB:Streams may be combined, in which case capacity will be adjusted)

B-C Stream

| Intercept For Stream B-C | Slope For Opposing Stream A-C | Slope For Opposing Stream A-B |
|--------------------------|-------------------------------|-------------------------------|
| 584.39 | 0.23 | 0.09 |

D-A Stream

| Intercept For Stream D-A | Slope For Opposing Stream C-A | Slope For Opposing Stream C-D |
|--------------------------|-------------------------------|-------------------------------|
| 599.44 | 0.23 | 0.09 |

B-A Stream

| Intercept For Stream B-A | Slope For Opposing Stream A-C | Slope For Opposing Stream A-D | Slope For Opposing Stream D-A | Slope For Opposing Stream D-B |
|--------------------------|-------------------------------|-------------------------------|-------------------------------|-------------------------------|
| 468.51 | 0.22 | 0.22 | 0.22 | 0.22 |

| Slope For Opposing Stream A-B | Slope For Opposing Stream C-A | Slope For Opposing Stream C-B | Slope For Opposing Stream D-C |
|-------------------------------|-------------------------------|-------------------------------|-------------------------------|
| 0.09 | 0.14 | 0.31 | 0.11 |

D-C Stream

| Intercept For Stream D-C | Slope For Opposing Stream C-A | Slope For Opposing Stream C-B | Slope For Opposing Stream B-C | Slope For Opposing Stream B-D |
|--------------------------|-------------------------------|-------------------------------|-------------------------------|-------------------------------|
| 467.27 | 0.22 | 0.22 | 0.22 | 0.22 |

| Slope For Opposing Stream C-D | Slope For Opposing Stream A-C | Slope For Opposing Stream A-D | Slope For Opposing Stream B-A |
|-------------------------------|-------------------------------|-------------------------------|-------------------------------|
| 0.09 | 0.14 | 0.31 | 0.11 |

C-B Stream

| Intercept For Stream C-B | Slope For Opposing Stream A-C | Slope For Opposing Stream A-D |
|--------------------------|-------------------------------|-------------------------------|
| 595.39 | 0.23 | 0.33 |

A-D Stream

| I | Intercept For Stream A-D | Slope For Opposing Stream C-A | Slope For Opposing Stream C-B | I |
|---|--------------------------|-------------------------------|-------------------------------|---|
| I | 612.76 | 0.23 | 0.34 | I |

B-D Stream From Left Hand Lane

| I | Intercept For Stream B-D | Slope For Opposing Stream A-C | Slope For Opposing Stream A-D | Slope For Opposing Stream A-B | Slope For Opposing Stream C-B | I |
|---|--------------------------|-------------------------------|-------------------------------|-------------------------------|-------------------------------|---|
| I | 468.51 | 0.22 | 0.22 | 0.09 | 0.31 | I |

| I | Slope For Opposing Stream C-A | Slope For Opposing Stream C-D | Slope For Opposing Stream C-B | I |
|---|-------------------------------|-------------------------------|-------------------------------|---|
| I | 0.14 | 0.14 | | I |

B-D Stream From Right Hand Lane

| I | Intercept For Stream B-D | Slope For Opposing Stream A-C | Slope For Opposing Stream A-D | Slope For Opposing Stream A-B | Slope For Opposing Stream C-B | I |
|---|--------------------------|-------------------------------|-------------------------------|-------------------------------|-------------------------------|---|
| I | 468.51 | 0.22 | 0.22 | 0.09 | 0.31 | I |

| I | Slope For Opposing Stream C-A | Slope For Opposing Stream C-D | Slope For Opposing Stream C-B | I |
|---|-------------------------------|-------------------------------|-------------------------------|---|
| I | 0.14 | 0.14 | | I |

D-B Stream From Left Hand Lane

| I | Intercept For Stream D-B | Slope For Opposing Stream C-A | Slope For Opposing Stream C-B | Slope For Opposing Stream D-C | Slope For Opposing Stream A-D | I |
|---|--------------------------|-------------------------------|-------------------------------|-------------------------------|-------------------------------|---|
| I | 467.27 | 0.22 | 0.22 | 0.09 | 0.31 | I |

| I | Slope For Opposing Stream A-C | Slope For Opposing Stream A-B | Slope For Opposing Stream C-B | I |
|---|-------------------------------|-------------------------------|-------------------------------|---|
| I | 0.14 | 0.14 | | I |

D-B Stream From Right Hand Lane

| I | Intercept For Stream D-B | Slope For Opposing Stream C-A | Slope For Opposing Stream C-B | Slope For Opposing Stream C-D | Slope For Opposing Stream A-D | I |
|---|--------------------------|-------------------------------|-------------------------------|-------------------------------|-------------------------------|---|
| I | 467.27 | 0.22 | 0.22 | 0.09 | 0.31 | I |

| I | Slope For Opposing Stream A-C | Slope For Opposing Stream A-B | Slope For Opposing Stream C-B | I |
|---|-------------------------------|-------------------------------|-------------------------------|---|
| I | 0.14 | 0.14 | | I |

TRAFFIC DEMAND DATA

| I | TIME | DEMAND (VEH/MIN) | CAPACITY (VEH/MIN) | DEMAND/ CAPACITY (RFC) | PEDESTRIAN FLOW (PEDS/MIN) | START QUEUE (VEHS) | END QUEUE (VEHS) | DELAY (VEH.MIN/ TIME SEGMENT) | GEOMETRIC DELAY (VEH.MIN/ TIME SEGMENT) | AVERAGE DELAY PER ARRIVING VEHICLE (MIN) | I |
|---|-------------|---------------------|-----------------------|------------------------------|----------------------------------|--------------------------|------------------------|-------------------------------------|---|--|---|
| I | 18.00-18.15 | | | | | | | | | | I |
| I | B-CD | 2.11 | 8.25 | 0.256 | | 0.48 | 0.35 | 5.4 | | 0.16 | I |
| I | B-AD | 1.91 | 8.86 | 0.216 | | 0.36 | 0.28 | 4.3 | | 0.14 | I |
| I | A-BCD | 0.72 | 9.68 | 0.075 | | 0.10 | 0.08 | 1.3 | | 0.11 | I |
| I | A-B | 0.24 | | | | | | | | | I |
| I | A-C | 0.01 | | | | | | | | | I |
| I | D-AB | 3.86 | 8.28 | 0.466 | | 1.49 | 0.90 | 14.3 | | 0.23 | I |
| I | D-BC | 3.05 | 9.01 | 0.339 | | 0.70 | 0.52 | 8.1 | | 0.17 | I |
| I | C-ABD | 1.06 | 10.82 | 0.098 | | 0.17 | 0.13 | 2.0 | | 0.10 | I |
| I | C-D | 1.57 | | | | | | | | | I |
| I | C-A | 0.02 | | | | | | | | | I |
| I | | | | | | | | | | | I |

WARNING NO MARGINAL ANALYSIS OF CAPACITIES AS MAJOR ROAD BLOCKING MAY OCCUR

QUEUE FOR STREAM B-CD

| TIME SEGMENT ENDING | NO. OF VEHICLES IN QUEUE |
|------------------------|--------------------------------|
| 17.00 | 0.3 |
| 17.15 | 0.5 |
| 17.30 | 0.7 * |
| 17.45 | 0.7 * |
| 18.00 | 0.5 |
| 18.15 | 0.3 |

QUEUE FOR STREAM B-AD

| TIME SEGMENT ENDING | NO. OF VEHICLES IN QUEUE |
|------------------------|--------------------------------|
| 17.00 | 0.3 |
| 17.15 | 0.4 |
| 17.30 | 0.5 |
| 17.45 | 0.5 |
| 18.00 | 0.4 |
| 18.15 | 0.3 |

QUEUE FOR STREAM A-BCD

| TIME SEGMENT ENDING | NO. OF VEHICLES IN QUEUE |
|------------------------|--------------------------------|
| 17.00 | 0.1 |
| 17.15 | 0.1 |
| 17.30 | 0.1 |
| 17.45 | 0.1 |
| 18.00 | 0.1 |
| 18.15 | 0.1 |

QUEUE FOR STREAM D-AB

| TIME SEGMENT ENDING | NO. OF VEHICLES IN QUEUE |
|------------------------|--------------------------------|
| 17.00 | 0.8 * |
| 17.15 | 1.4 * |
| 17.30 | 3.0 *** |
| 17.45 | 3.2 *** |
| 18.00 | 1.5 * |
| 18.15 | 0.9 * |

QUEUE FOR STREAM D-BC

| TIME SEGMENT ENDING | NO. OF VEHICLES IN QUEUE |
|------------------------|--------------------------------|
| 17.00 | 0.5 * |
| 17.15 | 0.7 * |
| 17.30 | 1.0 * |
| 17.45 | 1.0 * |
| 18.00 | 0.7 * |
| 18.15 | 0.5 * |

QUEUE FOR STREAM C-ABD

| TIME SEGMENT ENDING | NO. OF VEHICLES IN QUEUE |
|---------------------|--------------------------|
| 17.00 | 0.1 |
| 17.15 | 0.2 |
| 17.30 | 0.2 |
| 17.45 | 0.2 |
| 18.00 | 0.2 |
| 18.15 | 0.1 |

QUEUEING DELAY INFORMATION OVER WHOLE PERIOD

| I | STREAM | I | TOTAL DEMAND | I | * QUEUEING * | I | * INCLUSIVE QUEUEING * | I |
|---|--------|---|--------------|---|--------------|---|------------------------|---|
| I | I | I | I | I | * DELAY * | I | * DELAY * | I |
| I | I | I | (VEH) | I | (MIN) | I | (MIN) | I |
| I | I | I | (VEH/H) | I | (MIN/VEH) | I | (MIN/VEH) | I |
| I | B-CD | I | 235.7 | I | 44.8 | I | 44.8 | I |
| I | B-AD | I | 206.2 | I | 33.3 | I | 33.3 | I |
| I | A-BCD | I | 80.0 | I | 9.6 | I | 9.6 | I |
| I | A-B | I | 26.1 | I | | I | | I |
| I | A-C | I | 1.2 | I | | I | | I |
| I | D-AB | I | 433.8 | I | 154.6 | I | 154.7 | I |
| I | D-BC | I | 324.6 | I | 64.4 | I | 64.4 | I |
| I | C-ABD | I | 122.0 | I | 15.9 | I | 15.9 | I |
| I | C-D | I | 167.4 | I | | I | | I |
| I | C-A | I | 2.4 | I | | I | | I |
| I | ALL | I | 1599.4 | I | 322.6 | I | 322.7 | I |

* DELAY IS THAT OCCURRING ONLY WITHIN THE TIME PERIOD .
 * INCLUSIVE DELAY INCLUDES DELAY SUFFERED BY VEHICLES WHICH ARE STILL QUEUEING AFTER THE END OF THE TIME PERIOD.
 * THESE WILL ONLY BE SIGNIFICANTLY DIFFERENT IF THERE IS A LARGE QUEUE REMAINING AT THE END OF THE TIME PERIOD.

END OF JOB

===== end of file =====

Appendix G

Accident Records

Accidents between dates 01/08/2001 and 31/07/2006 (60) months

Selection: Notes:

Selected using Manual Selection

Thursday 02/08/2001 Time 2125 Slight at B430 O/S FOX & HOUNDS PH ARDLEY

E: 454307 N: 227489 Junction Detail: 8 Control 4

Raining without high winds Road surface Wet/Damp Darkness: no street lighting

Vehicle Reference 1 Car Moving from E to N Turning right

Casualty Reference: 1 Age: 14 Male Passenger Severity: Slight Injured by vehicle: 1

Vehicle Reference 2 Car Moving from N to S Going ahead other

Vehicle Reference 3 Car Moving from N to S Going ahead other

1001

~~Sunday 12/08/2001 Time 1448 Slight at M40 SBOUND AT MP 104/1 BUCKNELL~~

~~E: 454980 N: 226050 Junction Detail: 0 Control~~

~~Fine without high winds Road surface Dry Daylight: no street lighting~~

~~Vehicle Reference 1 Car Moving from N to S Going ahead other~~

~~Casualty Reference: 1 Age: 17 Female Passenger Severity: Slight Injured by vehicle: 1~~

~~Casualty Reference: 2 Age: 12 Female Passenger Severity: Slight Injured by vehicle: 1~~

~~Casualty Reference: 3 Age: 15 Male Passenger Severity: Slight Injured by vehicle: 1~~

Thursday 23/08/2001 Time 1630 Slight at B4030 AT STEEPLE ASTON / ROUSHAM CROSROADS ROUSHAM

E: 447784 N: 224793 Junction Detail: 6 Control 2

Raining without high winds Road surface Wet/Damp Daylight: no street lighting

Vehicle Reference 1 Car Moving from N to SE Going ahead other

Vehicle Reference 2 Car Moving from S to N Going ahead other

Casualty Reference: 1 Age: 55 Female Driver/rider Severity: Slight Injured by vehicle: 2

Vehicle Reference 3 Car Moving from N to SE Turning left

1003

Accidents between dates 01/08/2001 and 31/07/2006 (60) months

Selection: Notes:
Selected using Manual Selection

~~Wednesday 29/08/2001 Time 1140 Slight at M40 SBOUND AT MP105/1 ARDLEY
E: 454962 N: 226908 Junction Detail: 0 Control
Fine without high winds Road surface Dry Daylight: street lighting
Vehicle Reference 1 Goods 7.5 tonnes mgw and over Moving from N to S Overtaking moving vehicle O/S
Vehicle Reference 2 Goods 2.5 tonnes mgw and under Moving from N to S Going ahead other
Casualty Reference: 1 Age: 40 Male Driver/rider Severity: Slight Injured by vehicle: 2~~

~~Sunday 02/09/2001 Time 1745 Serious at M40 NBOUND AT MP105/7 STOKE LYNE
E: 454882 N: 227486 Junction Detail: 0 Control
Fine without high winds Road surface Dry Daylight: no street lighting
Vehicle Reference 1 Car Moving from S to N Going ahead other
Casualty Reference: 1 Age: 56 Female Driver/rider Severity: Serious Injured by vehicle: 1~~

Tuesday 18/09/2001 Time 0843 Slight at A4260 AT HOPCROFTS HOLT J/W B4030 STEEPLE ASTON
E: 446532 N: 225069 Junction Detail: 3 Control 2
Other Road surface Wet/Damp Daylight: no street lighting
Vehicle Reference 1 Car Moving from S to E Turning right
Casualty Reference: 1 Age: 48 Female Driver/rider Severity: Slight Injured by vehicle: 1
Casualty Reference: 3 Age: 32 Female Passenger Severity: Slight Injured by vehicle: 1
Vehicle Reference 2 Car Moving from N to S Going ahead other
Casualty Reference: 2 Age: 22 Female Driver/rider Severity: Slight Injured by vehicle: 2

1006

Accidents between dates 01/08/2001 and 31/07/2006 (60) months

Selection: Notes:

Selected using Manual Selection

Saturday 22/09/2001 Time 0745 Slight at A43 APPROX 25M N OF RBT AT J10 J/W M40 SBOUND EXIT SLIP RBT ARDLEY
E: 454810 N: 228164 Junction Detail: 0 Control
Fine without high winds Road surface Dry Daylight:street lights present

1007

Vehicle Reference 1 Car Moving from N to SW Going ahead right bend
Casualty Reference: 1 Age: 66 Female Driver/rider Severity: Slight Injured by vehicle: 1
Vehicle Reference 2 Car Moving from SW to N Going ahead left bend

Thursday 27/09/2001 Time 1844 Slight at WATER STREET BY OLD INN SOMERTON
E: 449706 N: 228931 Junction Detail: 0 Control
Fine without high winds Road surface Dry Daylight: street lighting unknown

1008

Vehicle Reference 1 Car Moving from N to E Going ahead left bend
Casualty Reference: 1 Age: 65 Female Pedestrian Severity: Slight Injured by vehicle: 1

~~Friday 28/09/2001 Time 1455 Slight at M40 SBOUND ON APPROACH TO EXIT SLIP AT J10 ARDLEY
E: 454547 N: 228460 Junction Detail: 5 Control 4
Fine without high winds Road surface Dry Daylight: no street lighting~~

~~Vehicle Reference 1 Goods 7.5 tonnes mgw and over Moving from N to SE Going ahead other
Vehicle Reference 2 Minibus Moving from N to SE Stopping
Casualty Reference: 1 Age: 17 Female Passenger Severity: Slight Injured by vehicle: 2
Casualty Reference: 2 Age: 19 Male Passenger Severity: Slight Injured by vehicle: 2
Vehicle Reference 3 Car Moving from N to SE Changing lane to left~~

Accidents between dates 01/08/2001 and 31/07/2006 (60) months

Selection: Notes:

Selected using Manual Selection

Saturday 06/10/2001 Time 0946 Slight at CAMP RD AT BEND BY J/W ARDLEY RD UPPER HEYFORD
E: 452190 N: 225655 Junction Detail: 3 Control 4
Fine without high winds Road surface Wet/Damp Daylight:street lights present
Vehicle Reference 1 Car Moving from W to SE Going ahead right bend
Casualty Reference: 1 Age: 30 Male Driver/rider Severity: Slight Injured by vehicle: 1

1010

Tuesday 09/10/2001 Time 0821 Slight at SOMERTON RD APPROX 250M SW OF FRITWELL VILLAGE
E: 452028 N: 229262 Junction Detail: 0 Control
Fine without high winds Road surface Wet/Damp Daylight: no street lighting
Vehicle Reference 1 Motor Cycle over 125 cc and up to 500cc Moving from NE to W Going ahead right bend
Casualty Reference: 1 Age: 29 Male Driver/rider Severity: Slight Injured by vehicle: 1
Vehicle Reference 2 Bus or coach Moving from W to NE Going ahead left bend

1011

Sunday 28/10/2001 Time 0450 Slight at B4030 BEND JUST E OF LIME HOLLOW LOWER HEYFORD
E: 451818 N: 224588 Junction Detail: 0 Control
Raining without high winds Road surface Wet/Damp Darkness: no street lighting
Vehicle Reference 1 Car Moving from SW to SE Going ahead right bend
Casualty Reference: 1 Age: 18 Female Passenger Severity: Slight Injured by vehicle: 1

1012

Saturday 10/11/2001 Time 1358 Slight at A43 APPROX 40M N OF RBT J/W CHERWELL VALLEY SERVICES STOKE LYNE
E: 454814 N: 228168 Junction Detail: 0 Control
Fine without high winds Road surface Dry Daylight: no street lighting
Vehicle Reference 1 Car Moving from N to S Going ahead other

1013

Accidents between dates 01/08/2001 and 31/07/2006 (60) months

Selection: Notes:

Selected using Manual Selection

| | | | | | |
|-----------------------|---------|--------|--------------------|-------------------|-----------------------|
| Casualty Reference: 3 | Age: 36 | Female | Passenger | Severity: Slight | Injured by vehicle: 1 |
| Vehicle Reference 2 | Car | | Moving from S to N | Going ahead other | |
| Casualty Reference: 1 | Age: 26 | Female | Driver/rider | Severity: Slight | Injured by vehicle: 2 |
| Casualty Reference: 2 | Age: 23 | Male | Passenger | Severity: Slight | Injured by vehicle: 2 |

Thursday 22/11/2001 Time 1644 Fatal at B430 AT J/W BUCKNELL/ARDLEY RD ARDLEY
E: 454323 N: 227550 Junction Detail: 3 Control 4
Fine without high winds Road surface Dry Darkness: no street lighting

1014

| | | | | | |
|-----------------------|---------|------|----------------------|-------------------|-----------------------|
| Vehicle Reference 1 | Car | | Moving from SW to NE | Going ahead other | |
| Casualty Reference: 1 | Age: 64 | Male | Pedestrian | Severity: Fatal | Injured by vehicle: 1 |

Thursday 29/11/2001 Time 1840 Serious at B430 AT J/W HEYFORD TURN ARDLEY
E: 453780 N: 225568 Junction Detail: 3 Control 4
Raining without high winds Road surface Wet/Damp Darkness: no street lighting

1015

| | | | | | |
|-----------------------|-------------------------------|------|----------------------|-------------------|-----------------------|
| Vehicle Reference 1 | Car | | Moving from N to NE | Turning left | |
| Casualty Reference: 1 | Age: 21 | Male | Driver/rider | Severity: Serious | Injured by vehicle: 1 |
| Vehicle Reference 2 | Goods 7.5 tonnes mgw and over | | Moving from SW to NE | Going ahead other | |

Sunday 02/12/2001 Time 1805 Slight at B430 APPROX 200M W OF J/W M40 STOKE LYNE (NOTE : NEW RD LAYOUT - CHECK LOCATION PLOTTED)
E: 454513 N: 227895 Junction Detail: 0 Control
Fine without high winds Road surface Wet/Damp Darkness: no street lighting

1016

| | | | | | |
|-----------------------|---------|--------|---------------------|------------------------|-----------------------|
| Vehicle Reference 1 | Car | | Moving from NE to W | Going ahead right bend | |
| Casualty Reference: 1 | Age: 30 | Female | Passenger | Severity: Slight | Injured by vehicle: 1 |
| Casualty Reference: 2 | Age: 67 | Female | Passenger | Severity: Slight | Injured by vehicle: 1 |
| Casualty Reference: 3 | Age: 66 | Male | Passenger | Severity: Slight | Injured by vehicle: 1 |

Accidents between dates 01/08/2001 and 31/07/2006 (60) months

Selection: Notes:
Selected using Manual Selection

Vehicle Reference 2 Car Moving from W to NE Going ahead left bend

1017

Sunday 02/12/2001 Time 1425 Slight at A4260 OXFORD RD J/W STEEPLE ASTON TURN STEEPLE ASTON
E: 446493 N: 225848 Junction Detail: 3 Control 4
Fine without high winds Road surface Dry Daylight: no street lighting

Vehicle Reference 1 Car Moving from S to N Going ahead other

Casualty Reference: 2 Age: 99 Female Passenger Severity: Slight Injured by vehicle: 1

Vehicle Reference 2 Car Moving from S to N Going ahead but held up

Casualty Reference: 1 Age: 46 Male Driver/rider Severity: Slight Injured by vehicle: 2

Vehicle Reference 3 Car Moving from S to E Waiting to turn right

Monday 03/12/2001 Time 0615 Slight at KIRTLINGTON ROAD / PORTWAY APPROX 100M S OF J/W THE B4030 LOWER HEYFORD
E: 449943 N: 224064 Junction Detail: 0 Control
Fine without high winds Road surface Dry Darkness: no street lighting

1018

Vehicle Reference 1 Car Moving from S to NE Going ahead right bend

Casualty Reference: 1 Age: 32 Male Driver/rider Severity: Slight Injured by vehicle: 1

Monday 17/12/2001 Time 0732 Slight at A43 AT RBT J/W M40 & CHERWELL VALLEY SERVICES STOKE LYNE
E: 454806 N: 228119 Junction Detail: 1 Control 4
Fine without high winds Road surface Wet/Damp Darkness: street lights present and lit

1019

Vehicle Reference 1 Car Moving from N to S Starting

Vehicle Reference 2 Pedal Cycle Moving from SW to SE Turning right

Casualty Reference: 1 Age: 46 Female Driver/rider Severity: Slight Injured by vehicle: 2

Accidents between dates 01/08/2001 and 31/07/2006 (60) months

Selection: Notes:

Selected using Manual Selection

~~Saturday 29/12/2001 Time 1905 Slight at A43 AT M40 J10 OVERBRIDGE ARDLEY
E: 454722 N: 228055 Junction Detail: 0 Control
Fine without high winds Road surface Wet/Damp Darkness: street lights present and lit
Vehicle Reference 1 Car Moving from SW to NE Going ahead other
Casualty Reference: 1 Age: 44 Female Passenger Severity: Slight Injured by vehicle: 1
Vehicle Reference 2 Car Moving from NE to SW Going ahead other~~

Wednesday 09/01/2002 Time 0724 Slight at A4260 J/W B4030 AT HOPCROFTS HOLT STEEPLE ASTON
E: 446528 N: 225124 Junction Detail: 6 Control 2
Fine without high winds Road surface Wet/Damp Darkness: street lighting unknown
Vehicle Reference 1 Car Moving from N to S Going ahead other
Vehicle Reference 2 Car Moving from N to S Going ahead other
Casualty Reference: 1 Age: 47 Male Driver/rider Severity: Slight Injured by vehicle: 2

1021

Saturday 26/01/2002 Time 1450 Slight at B4030 450 M E OF CAULCOTT CROSSROADS LOWER HEYFORD
E: 450471 N: 224397 Junction Detail: 0 Control
Raining without high winds Road surface Wet/Damp Daylight: no street lighting
Vehicle Reference 1 Car Moving from E to W Going ahead other
Casualty Reference: 1 Age: 25 Male Driver/rider Severity: Slight Injured by vehicle: 1

1022

~~Friday 01/03/2002 Time 1334 Slight at M40 NBOUND AT MP 104/3 BUCKNELL
E: 454965 N: 226092 Junction Detail: 0 Control
Fine without high winds Road surface Dry Daylight: no street lighting~~

Accidents between dates 01/08/2001 and 31/07/2006 (60) months

Selection: Notes:
Selected using Manual Selection

Vehicle Reference 1 Goods 7.5 tonnes mgw and over Moving from S to N Going ahead other
 Casualty Reference: 1 Age: 44 Male Driver/rider Severity: Slight Injured by vehicle: 1
 Casualty Reference: 2 Age: 25 Male Passenger Severity: Slight Injured by vehicle: 1
 Vehicle Reference 2 Goods 3.5 tonnes mgw and under Moving from S to N Going ahead other

Tuesday 05/03/2002 Time 0834 Slight at B4030 AT BEND 0.7KM E OF CAULCOTT VILLAGE LOWER HEYFORD
 E: 451553 N: 224467 Junction Detail: 0 Control
 Fine without high winds Road surface Wet/Damp Daylight: no street lighting

1024

Vehicle Reference 1 Car Moving from W to NE Going ahead left bend
 Casualty Reference: 1 Age: 59 Male Driver/rider Severity: Slight Injured by vehicle: 1

Monday 11/03/2002 Time 1530 Slight at B4030 AT J/W B4030 STATION RD LOWER HEYFORD
 E: 449252 N: 224749 Junction Detail: 3 Control 4
 Fine without high winds Road surface Wet/Damp Daylight: street lights present

1025

Vehicle Reference 1 Car Moving from SE to N Going ahead other
 Vehicle Reference 2 Car Moving from SE to SW Waiting to turn left
 Casualty Reference: 1 Age: 57 Male Driver/rider Severity: Slight Injured by vehicle: 2

Wednesday 13/03/2002 Time 1227 Slight at B430 BY FOX AND HOUNDS PH ARDLEY
 E: 454299 N: 227462 Junction Detail: 8 Control 4
 Fine without high winds Road surface Dry Daylight: no street lighting

1026

Vehicle Reference 1 Car Moving from N to N U-turn
 Casualty Reference: 1 Age: 20 Male Driver/rider Severity: Slight Injured by vehicle: 1
 Vehicle Reference 2 Car Moving from N to S Going ahead other

Accidents between dates 01/08/2001 and 31/07/2006 (60) months

Selection: Notes:
Selected using Manual Selection

Wednesday 20/03/2002 Time 1700 Slight at CAMP ROAD BY TRAFFIC CALMING BUILD OUT APPROX 150M W OF RBT J/W DACEY DRIVE UPEE
E: 450776 N: 225855 Junction Detail: 0 Control
Raining without high winds Road surface Wet/Damp Daylight:street lights present **1027**
Vehicle Reference 1 Car Moving from W to E Going ahead other
Vehicle Reference 2 Car Moving from E to W Going ahead other
Casualty Reference: 1 Age: 24 Female Driver/rider Severity: Slight Injured by vehicle: 2

Saturday 30/03/2002 Time 1930 Slight at B430 BY NORTH ENTRANCE TO DISUSED LAYBY 1.1KM S OF ARDELY WASTE SITE **1028**
E: 453716 N: 225264 Junction Detail: 0 Control
Fine without high winds Road surface Dry Darkness: no street lighting
Vehicle Reference 1 Car Moving from NE to SW Going ahead but held up
Casualty Reference: 1 Age: 40 Male Passenger Severity: Slight Injured by vehicle: 1
Vehicle Reference 2 Car Moving from NE to SW Going ahead other

Saturday 06/04/2002 Time 2135 Slight at SOUTH SIDE BY ST PETERS COTTAGE 50M NW OF J/W PAINES HILL STEEPLE ASTON **1029**
E: 447539 N: 225675 Junction Detail: 0 Control
Fine without high winds Road surface Dry Darkness: no street lighting
Vehicle Reference 1 Car Moving from N to SE Going ahead other
Casualty Reference: 1 Age: 74 Female Driver/rider Severity: Slight Injured by vehicle: 1
Vehicle Reference 2 Car Moving from to 0 Parked

Accidents between dates 01/08/2001 and 31/07/2006 (60) months

Selection: Notes:
Selected using Manual Selection

1030

Thursday 18/04/2002 Time 1005 Slight at B430 J/W ARDLEY ROAD ARDLEY
E: 454324 N: 227580 Junction Detail: 3 Control 4
Fine without high winds Road surface Dry Daylight: no street lighting
Vehicle Reference 1 Minibus Moving from N to E Going ahead left bend
Casualty Reference: 1 Age: 21 Female Passenger Severity: Slight Injured by vehicle: 1
Casualty Reference: 2 Age: 18 Male Passenger Severity: Slight Injured by vehicle: 1
Casualty Reference: 3 Age: 34 Female Passenger Severity: Slight Injured by vehicle: 1
Vehicle Reference 2 Other motor vehicle Moving from to 0 Parked

1031

Wednesday 22/05/2002 Time 0852 Serious at B430 AT SITE ENTRANCE BY OLD ARDLEY STATION JUST N OF ARDLEY RAILWAY BRIDGE ARDLEY
E: 454105 N: 226762 Junction Detail: 8 Control 4
Fine without high winds Road surface Wet/Damp Daylight: no street lighting
Vehicle Reference 1 Car Moving from NE to N Turning right
Casualty Reference: 1 Age: 33 Male Driver/rider Severity: Slight Injured by vehicle: 1
Vehicle Reference 2 Car Moving from SW to NE Going ahead other
Casualty Reference: 2 Age: 36 Male Driver/rider Severity: Serious Injured by vehicle: 2

1032

Tuesday 28/05/2002 Time 1635 Slight at B430 J/W ACCESS TO OLD ARDLEY STATION JUST N OF RAIL BRIDGE ARDLEY
E: 454109 N: 226759 Junction Detail: 8 Control 4
Raining without high winds Road surface Wet/Damp Daylight: no street lighting
Vehicle Reference 1 Car Moving from N to SW Turning right
Casualty Reference: 1 Age: 27 Female Driver/rider Severity: Slight Injured by vehicle: 1
Vehicle Reference 2 Car Moving from SW to NE Going ahead other

Accidents between dates 01/08/2001 and 31/07/2006 (60) months

Selection: Notes:

Selected using Manual Selection

Thursday 06/06/2002 Time 0759 Slight at B4030 AT BEND BY PARK FARM MIDDLETON STONEY

E: 451983 N: 224384 Junction Detail: 0 Control

Fine without high winds Road surface Wet/Damp

Daylight: no street lighting

1033

Vehicle Reference 1 Car

Moving from E to N

Going ahead right bend

Casualty Reference: 1

Age: 21 Male

Passenger

Severity: Slight

Injured by vehicle: 1

Casualty Reference: 2

Age: 20 Male

Driver/rider

Severity: Slight

Injured by vehicle: 1

Tuesday 11/06/2002 Time 1610 Slight at B4030 AT J/W KIRTLINGTON RD LOWER HEYFORD

E: 449991 N: 224437 Junction Detail: 3 Control 4

Fine without high winds Road surface Dry

Daylight: no street lighting

1034

Vehicle Reference 1 Car

Moving from N to SE

Overtaking moving vehicle O/S

Casualty Reference: 1

Age: 79 Male

Driver/rider

Severity: Slight

Injured by vehicle: 1

Vehicle Reference 2 Taxi/Private hire car

Moving from N to S

Turning right

Wednesday 10/07/2002 Time 0819 Slight at A43 BETWEEN M40 J10 & BAYNARDS GREEN ARDLEY - EXACT LOCATION UNCERTAIN

E: 454791 N: 228269 Junction Detail: 0 Control

Fine without high winds Road surface Dry

Daylight:street lights present

1035

Vehicle Reference 1 Car

Moving from S to N

Stopping

Vehicle Reference 2 Car

Moving from S to N

Going ahead other

Casualty Reference: 1

Age: 19 Female

Passenger

Severity: Slight

Injured by vehicle: 2

Casualty Reference: 2

Age: 18 Female

Passenger

Severity: Slight

Injured by vehicle: 2

Accidents between dates 01/08/2001 and 31/07/2006 (60) months

Selection: Notes:

Selected using Manual Selection

Friday 12/07/2002 Time 1912 Slight at A4260 AT DUAL CWAY S OF DUNS TEW TURN MIDDLE ASTON 1036
E: 446436 N: 227277 Junction Detail: 0 Control
Fine without high winds Road surface Dry Daylight: no street lighting
Vehicle Reference 1 Car Moving from S to NE Going ahead right bend
Casualty Reference: 1 Age: 31 Female Driver/rider Severity: Slight Injured by vehicle: 1

~~Friday 19/07/2002 Time 0850 Slight at M40 SBOUND UNDER A43 BRIDGE AT J10 STOKE LYNE
E: 454735 N: 228054 Junction Detail: 0 Control
Fine without high winds Road surface Dry Daylight: no street lighting
Vehicle Reference 1 Goods 7.5 tonnes mgw and over Moving from N to S Changing lane to right
Vehicle Reference 2 Car Moving from N to S Going ahead other
Casualty Reference: 1 Age: 39 Male Driver/rider Severity: Slight Injured by vehicle: 2~~

Tuesday 23/07/2002 Time 0820 Slight at CAMP RD AT J/W LARSEN RD UPPER HEYFORD 1038
E: 451811 N: 225721 Junction Detail: 6 Control 4
Fine without high winds Road surface Dry Daylight:street lights present
Vehicle Reference 1 Motor Cycle over 50 cc and up to 125cc Moving from E to W Overtaking moving vehicle O/S
Casualty Reference: 1 Age: 19 Male Driver/rider Severity: Slight Injured by vehicle: 1
Vehicle Reference 2 Car Moving from E to N Turning right

Friday 02/08/2002 Time 1930 Serious at B4030 AT CROSSROADS J/W UPPER HEYFORD & KIRTLINGTON ROADS LOWER HEYFORD 1039
E: 449988 N: 224437 Junction Detail: 3 Control 4
Fine without high winds Road surface Dry Daylight: no street lighting

Accidents between dates 01/08/2001 and 31/07/2006 (60) months

Selection: Notes:

Selected using Manual Selection

| | | | | | | |
|---------------------|-----|------|----|--------------------|-------------------|---|
| Vehicle Reference 1 | Car | | | Moving from S to E | Turning right | |
| Casualty Reference: | 1 | Age: | 79 | Male | Driver/rider | Severity: Serious Injured by vehicle: 1 |
| Vehicle Reference 2 | Car | | | Moving from E to W | Going ahead other | |

Thursday 08/08/2002 Time 1720 Slight at B4030 ON RIVER BRIDGE JUST E OF J/W ROUSHAM / STEEPLE ASTON CROSSROADS LOWER HEYFORD

E: 447816 N: 224777 Junction Detail: 0 Control

Fine without high winds Road surface Dry Daylight: no street lighting

| | | | | | | |
|---------------------|----|--|--|--------------------|-------------------|--|
| Vehicle Reference 1 | 22 | | | Moving from W to E | Going ahead other | |
|---------------------|----|--|--|--------------------|-------------------|--|

| | | | | | | |
|---------------------|-----|------|----|--------------------|-------------------|--|
| Vehicle Reference 2 | Car | | | Moving from E to W | Going ahead other | |
| Casualty Reference: | 1 | Age: | 59 | Female | Driver/rider | Severity: Slight Injured by vehicle: 2 |

1040

Wednesday 11/09/2002 Time 2154 Serious at B430 STATION RD AT RAILWAY BRIDGE ARDLEY

E: 454095 N: 226732 Junction Detail: 0 Control

Fine without high winds Road surface Dry Darkness: no street lighting

| | | | | | | |
|---------------------|-------------------------------|--|--|----------------------|-------------------|--|
| Vehicle Reference 1 | Goods 7.5 tonnes mgw and over | | | Moving from NE to SW | Going ahead other | |
|---------------------|-------------------------------|--|--|----------------------|-------------------|--|

| | | | | | | |
|---------------------|-----|------|----|----------------------|-------------------|---|
| Vehicle Reference 2 | Car | | | Moving from SW to NE | Going ahead other | |
| Casualty Reference: | 1 | Age: | 66 | Male | Driver/rider | Severity: Serious Injured by vehicle: 2 |

1041

Monday 21/10/2002 Time 1320 Slight at CAMP ROAD TO B4030 ROAD - POSSIBLY AT BEND APPROX 1KM N OF J/W B4030 BUT EXACT LOCATIO

E: 452266 N: 225432 Junction Detail: 0 Control

Fine without high winds Road surface Wet/Damp Daylight: no street lighting

| | | | | | | |
|---------------------|-----|--|--|--------------------|------------------------|--|
| Vehicle Reference 1 | Car | | | Moving from N to S | Going ahead right bend | |
|---------------------|-----|--|--|--------------------|------------------------|--|

| | | | | | | |
|---------------------|---|------|----|------|--------------|--|
| Casualty Reference: | 1 | Age: | 48 | Male | Driver/rider | Severity: Slight Injured by vehicle: 1 |
|---------------------|---|------|----|------|--------------|--|

1042

Accidents between dates 01/08/2001 and 31/07/2006 (60) months

Selection: Notes:

Selected using Manual Selection

Thursday 31/10/2002 Time 0015 Slight at M40 J10 NBOUND EXIT SLIP RD APPROX 100M S OF RBT J/W B430 STOKE LYNE
E: 454727 N: 227903 Junction Detail: 0 Control
Fine without high winds Road surface Wet/Damp Darkness: no street lighting

1043

Vehicle Reference 1 Car Moving from S to N Going ahead left bend
Casualty Reference: 1 Age: 49 Male Driver/rider Severity: Slight Injured by vehicle: 1
Casualty Reference: 2 Age: 45 Female Passenger Severity: Slight Injured by vehicle: 1

Tuesday 05/11/2002 Time 1430 Serious at A4260 J/W STEEPLE ASTON TURN STEEPLE ASTON
E: 446496 N: 225851 Junction Detail: 3 Control 4
Fine without high winds Road surface Dry Daylight: no street lighting

1044

Vehicle Reference 1 Car Moving from to 0 Going ahead other
Vehicle Reference 2 Car Moving from to 0 Going ahead other
Casualty Reference: 1 Age: 57 Female Driver/rider Severity: Serious Injured by vehicle: 2
Casualty Reference: 2 Age: 42 Male Passenger Severity: Slight Injured by vehicle: 2

Wednesday 20/11/2002 Time 1024 Slight at A4260 DUNS TEW DUAL CWAY - EXACT LOCATION UNCERTAIN MIDDLE ASTON
E: 446744 N: 227825 Junction Detail: 0 Control
Raining without high winds Road surface Wet/Damp Daylight: no street lighting

1045

Vehicle Reference 1 Car Moving from S to N Going ahead other
Vehicle Reference 2 Car Moving from S to N Changing lane to right
Casualty Reference: 1 Age: 57 Male Driver/rider Severity: Slight Injured by vehicle: 2
Casualty Reference: 2 Age: 47 Female Passenger Severity: Slight Injured by vehicle: 2

Accidents between dates 01/08/2001 and 31/07/2006 (60) months

Selection: Notes:

Selected using Manual Selection

~~Thursday 21/11/2002 Time 2026 Slight at M40 NORTHBOUND J9.10 TRAFFMAP 104/4 BUCKNELL~~

~~E: 454968 N: 226211 Junction Detail: 0 Control~~

~~Fine without high winds~~

~~Road surface Dry~~

~~Darkness: no street lighting~~

~~Vehicle Reference 1 Car~~

~~Moving from S to N~~

~~Going ahead other~~

~~Casualty Reference: 1~~

~~Age: 32 Female~~

~~Passenger~~

~~Severity: Slight~~

~~Injured by vehicle: 1~~

Monday 25/11/2002 Time 1149 Slight at B430 APPROX 400M N OF J/W B4030 BY ACCESS TO ALLOTMENTS MIDDLETON STONEY

E: 453322 N: 223872 Junction Detail: 8 Control 4

Fog or mist

Road surface Wet/Damp

Daylight: no street lighting

1047

Vehicle Reference 1 Car

Moving from NE to SE

Going ahead left bend

Casualty Reference: 1

Age: 27 Female

Driver/rider

Severity: Slight

Injured by vehicle: 1

Vehicle Reference 2 Car

Moving from W to E

Reversing

Thursday 28/11/2002 Time 0620 Slight at CAMP RD APPROX 30M E OF J/W SODEN RD UPPER HEYFORD

E: 451840 N: 225718 Junction Detail: 0 Control

Raining without high winds

Road surface Wet/Damp

Daylight: no street lighting

1048

Vehicle Reference 1 Car

Moving from E to W

Going ahead other

Vehicle Reference 2 Car

Moving from W to E

Going ahead other

Casualty Reference: 1

Age: 19 Male

Driver/rider

Severity: Slight

Injured by vehicle: 2

Sunday 01/12/2002 Time 2056 Serious at B430 AT J/W UPPER HEYFORD RD ARDLEY

E: 453781 N: 225563 Junction Detail: 3 Control 4

Fine without high winds

Road surface Wet/Damp

Darkness: no street lighting

1049

Accidents between dates 01/08/2001 and 31/07/2006 (60) months

Selection: Notes:
Selected using Manual Selection

| | | | | | | | |
|-----------------------|-----|---------|--------|--|----------------------|-------------------|-----------------------|
| Vehicle Reference 1 | Car | | | | Moving from NE to N | Turning right | |
| Casualty Reference: 1 | | Age: 57 | Female | | Driver/rider | Severity: Serious | Injured by vehicle: 1 |
| Vehicle Reference 2 | Car | | | | Moving from N to NE | Turning left | |
| Casualty Reference: 2 | | Age: 20 | Male | | Driver/rider | Severity: Serious | Injured by vehicle: 2 |
| Vehicle Reference 3 | Car | | | | Moving from SW to NE | Going ahead other | |

Thursday 05/12/2002 Time 1430 Serious at A4260 AT STEEPLE ASTON TURN STEEPLE ASTON
E: 446461 N: 226265 Junction Detail: 3 Control 4
Fine without high winds Road surface Dry Daylight: no street lighting

1050

| | | | | | | | |
|-----------------------|-----|---------|--------|--|--------------------|-------------------|-----------------------|
| Vehicle Reference 1 | Car | | | | Moving from S to E | Turning right | |
| Casualty Reference: 2 | | Age: 42 | Male | | Passenger | Severity: Slight | Injured by vehicle: 1 |
| Vehicle Reference 2 | Car | | | | Moving from N to S | Going ahead other | |
| Casualty Reference: 1 | | Age: 57 | Female | | Driver/rider | Severity: Serious | Injured by vehicle: 2 |

Wednesday 18/12/2002 Time 1907 Serious at B4030 STATION ROAD BY WOODSIDE COTTAGE LOWER HEYFORD
E: 448712 N: 224635 Junction Detail: 0 Control
Fine without high winds Road surface Dry Darkness: no street lighting

1051

| | | | | | | | |
|-----------------------|--|---------|--------|--|--------------------|-------------------|-----------------------|
| Vehicle Reference 1 | Car | | | | Moving from E to W | Going ahead other | |
| Casualty Reference: 1 | | Age: 49 | Female | | Driver/rider | Severity: Serious | Injured by vehicle: 1 |
| Casualty Reference: 2 | | Age: 18 | Female | | Passenger | Severity: Serious | Injured by vehicle: 1 |
| Vehicle Reference 2 | Goods over 3.5 tonnes and under 7.5 tonnes mgw | | | | Moving from to 0 | Parked | |
| Vehicle Reference 3 | Car | | | | Moving from W to E | Stopping | |

Accidents between dates 01/08/2001 and 31/07/2006 (60) months

Selection: Notes:

Selected using Manual Selection

Friday 27/12/2002 Time 1400 Slight at A4260 AT STAGGERED CROSSROADS WITH B4030 AT HOPCROFTS HOLT STEEPLE ASTON

E: 446528 N: 225067 Junction Detail: 3 Control 2

Fine without high winds Road surface Dry

Daylight: no street lighting

1052

Vehicle Reference 1 Goods 3.5 tonnes mgw and under

Moving from S to E Turning right

Vehicle Reference 2 Car

Moving from N to S Going ahead other

Casualty Reference: 1 Age: 56 Female Driver/rider Severity: Slight Injured by vehicle: 2

~~Sunday 29/12/2002 Time 1612 Slight at A43 OVERBRIDGE OVER M40 AT J10 STOKE LYNE~~

~~E: 454726 N: 228061 Junction Detail: 0 Control~~

~~Raining without high winds Road surface Wet/Damp~~

~~Darkness: street lights present and lit~~

~~Vehicle Reference 1 Car~~

~~Moving from SW to NE Going ahead other~~

~~Vehicle Reference 2 Car~~

~~Moving from SW to NE Stopping~~

~~Casualty Reference: 1 Age: 19 Female Passenger Severity: Slight Injured by vehicle: 2~~

~~Vehicle Reference 3 Car~~

~~Moving from SW to NE Going ahead but held up~~

Monday 06/01/2003 Time 1754 Slight at UPPER TO LOWER HEYFORD ROAD AT BEND APPROX 650M NE OF J/W B4030 LOWER HEYFORD

E: 449663 N: 225239 Junction Detail: 0 Control

Fine with high winds Road surface Frost/Ice

Darkness: no street lighting

1054

Vehicle Reference 1 Car

Moving from NE to SW Going ahead right bend

Casualty Reference: 1 Age: 53 Male Passenger Severity: Slight Injured by vehicle: 1

Casualty Reference: 2 Age: 22 Female Driver/rider Severity: Slight Injured by vehicle: 1

Accidents between dates 01/08/2001 and 31/07/2006 (60) months

Selection: Notes:

Selected using Manual Selection

Tuesday 14/01/2003 Time 0543 Serious at CAMP RD AT RBT AT MAIN ENTRANCE ONTO BASE UPPER HEYFORD
E: 451447 N: 225773 Junction Detail: 1 Control 4
Fine without high winds Road surface Wet/Damp Darkness: street lights present and lit

1055

Vehicle Reference 1 Motor Cycle over 50 cc and up to 125cc Moving from W to E Going ahead other
Casualty Reference: 1 Age: 33 Male Driver/rider Severity: Serious Injured by vehicle: 1

Monday 20/01/2003 Time 1937 Fatal at B480 STATION RD NEAR TO J/W CHURCH RD ARDLEY
E: 454278 N: 227373 Junction Detail: 0 Control
Fine without high winds Road surface Wet/Damp Darkness: no street lighting

1056

Vehicle Reference 1 Car Moving from N to S Going ahead other
Casualty Reference: 1 Age: 25 Male Pedestrian Severity: Fatal Injured by vehicle: 1
Vehicle Reference 2 Car Moving from S to N Going ahead other
Vehicle Reference 3 Car Moving from S to N Going ahead other

Tuesday 28/01/2003 Time 0733 Serious at B4030 BICESTER RD APPROX 20M E OF J/W B430 BY ACCESS TO THE OLD POST OFFICE MIDDLETO
E: 453507 N: 223476 Junction Detail: 8 Control 4
Fine without high winds Road surface Dry Darkness: no street lighting

1057

Vehicle Reference 1 Car Moving from S to E Turning right
Vehicle Reference 2 Motor Cycle over 125 cc and up to 500cc Moving from W to E Going ahead other
Casualty Reference: 1 Age: 45 Male Driver/rider Severity: Serious Injured by vehicle: 2

Accidents between dates 01/08/2001 and 31/07/2006 (60) months

Selection: Notes:

Selected using Manual Selection

Thursday 30/01/2003 Time 1520 Serious at CASTLEFIELDS RD OUTSIDE NO 10 ARDLEY

E: 453918 N: 227541 Junction Detail: 8 Control 4

Other Road surface Snow Daylight:street lights present

1058

Vehicle Reference 1 Car

Moving from S to N Reversing

Casualty Reference: 1 Age: 5 Male Pedestrian Severity: Serious Injured by vehicle: 1

Wednesday 19/02/2003 Time 1936 Slight at B4030 OUTSIDE TOLLGATE COTTAGE LOWER HEYFORD

E: 449173 N: 224692 Junction Detail: 0 Control

Fine without high winds Road surface Dry Darkness: no street lighting

1059

Vehicle Reference 1 Car

Moving from NE to SW Going ahead other

Vehicle Reference 2 Car

Moving from W to NE Going ahead left bend

Casualty Reference: 1 Age: 50 Female Driver/rider Severity: Slight Injured by vehicle: 2

~~Tuesday 25/02/2003 Time 1740 Fatal at M40 AT MP 106/3 BY J10 STOKE LYNE~~

~~E: 454757 N: 227958 Junction Detail: 0 Control~~

~~Fine without high winds Road surface Dry Darkness: no street lighting~~

~~Vehicle Reference 1 Goods 3.5 tonnes mgw and under~~

~~Moving from N to S Going ahead other~~

~~Casualty Reference: 2 Age: 28 Male Driver/rider Severity: Serious Injured by vehicle: 1~~

~~Vehicle Reference 2 Car~~

~~Moving from S to N Going ahead other~~

~~Casualty Reference: 1 Age: 57 Male Driver/rider Severity: Fatal Injured by vehicle: 2~~

~~Vehicle Reference 3 Car~~

~~Moving from S to N Going ahead other~~

Accidents between dates 01/08/2001 and 31/07/2006 (60) months

Selection: Notes:
Selected using Manual Selection

| | | | | | | | | |
|-------------------------|-------------------------------|--------------------|-----------|--------------------------------|--|-----------------------|------|--|
| Monday | 03/03/2003 | Time 1301 | Slight | at | B430 STATION RD O/S THE FOX & HOUNDS PH APPROX 50M S OF J/W BUCKNELL TURN ARDLEY | | | |
| E: 454306 | N: 227483 | Junction Detail: 8 | Control 4 | | | | | |
| Fine without high winds | | Road surface | Dry | Daylight:street lights present | | | | |
| Vehicle Reference 1 | Goods 7.5 tonnes mgw and over | | | Moving from N to S | Going ahead other | | 1061 | |
| Vehicle Reference 2 | Car | | | Moving from N to E | Turning left | | | |
| | Casualty Reference: 1 | Age: 43 | Female | Driver/rider | Severity: Slight | Injured by vehicle: 2 | | |
| | Casualty Reference: 2 | Age: 40 | Male | Passenger | Severity: Slight | Injured by vehicle: 2 | | |
| Friday | 07/03/2003 | Time 1745 | Slight | at | A43 AT RBT J/W M40 NORTH BOUND AT J10 STOKE LYNE | | | |
| E: 454766 | N: 228115 | Junction Detail: 1 | Control 4 | | | | | |
| Fine with high winds | | Road surface | Dry | Daylight:street lights present | | | | |
| Vehicle Reference 1 | Bus or coach | | | Moving from S to N | Changing lane to left | | 1062 | |
| Vehicle Reference 2 | Car | | | Moving from S to N | Going ahead other | | | |
| | Casualty Reference: 1 | Age: 27 | Female | Driver/rider | Severity: Slight | Injured by vehicle: 2 | | |
| Tuesday | 18/03/2003 | Time 2230 | Slight | at | B430 OXFORD RD AT J/W B4030 BICESTER RD CROSS ROADS MIDDLETON STONEY | | | |
| E: 453435 | N: 223475 | Junction Detail: 6 | Control 2 | | | | | |
| Fine without high winds | | Road surface | Dry | Darkness: no street lighting | | | | |
| Vehicle Reference 1 | Car | | | Moving from S to E | Turning right | | 1063 | |
| | Casualty Reference: 2 | Age: 26 | Male | Passenger | Severity: Slight | Injured by vehicle: 1 | | |
| Vehicle Reference 2 | Car | | | Moving from N to S | Going ahead other | | | |
| | Casualty Reference: 1 | Age: 26 | Female | Driver/rider | Severity: Slight | Injured by vehicle: 2 | | |

Accidents between dates 01/08/2001 and 31/07/2006 (60) months

Selection: Notes:

Selected using Manual Selection

~~Friday 04/04/2003 Time 1810 Slight at M40 SBOUND BY MP106/2 BY J10 STOKE LYNE
E: 454788 N: 227926 Junction Detail: 0 Control
Fine without high winds Road surface Dry Daylight: no street lighting
Vehicle Reference 1 Car Moving from N to SE Changing lane to left
Vehicle Reference 2 Car Moving from N to SE Going ahead other
Casualty Reference: 1 Age: 35 Male Driver/rider Severity: Slight Injured by vehicle: 2
Vehicle Reference 3 Goods over 3.5 tonnes and under 7.5 tonnes mgw Moving from N to SE Going ahead other~~

Tuesday 29/04/2003 Time 1936 Serious at A43 AT RBT J/W M40 NBOUND EXIT SLIP ROAD STOKE LYNE
E: 454532 N: 227891 Junction Detail: 1 Control 4
Fine with high winds Road surface Dry Daylight:street lights present
Vehicle Reference 1 Car Moving from S to N Overtaking nearside
Vehicle Reference 2 Goods 7.5 tonnes mgw and over Moving from SE to NE Turning right
Casualty Reference: 1 Age: 40 Male Driver/rider Severity: Serious Injured by vehicle: 2

1065

Tuesday 29/04/2003 Time 0720 Slight at CAMP RD UPPER HEYFORD - NO OTHER LOCATION DETAILS SUPPLIED
E: 451137 N: 225808 Junction Detail: 0 Control
Fine without high winds Road surface Dry Daylight:street lights present
Vehicle Reference 1 Car Moving from to 0 Going ahead other
Vehicle Reference 2 Pedal Cycle Moving from to 0 Going ahead other
Casualty Reference: 1 Age: 40 Male Driver/rider Severity: Slight Injured by vehicle: 2

1066

Accidents between dates 01/08/2001 and 31/07/2006 (60) months

Selection: Notes:

Selected using Manual Selection

Sunday 04/05/2003 Time 0120 Fatal at A4260 AT HOPCROFTS HOLT ATS AT J/W B4030 STEEPLE BARTON

E: 446516 N: 225092 Junction Detail: 3 Control 2

Fine without high winds Road surface Dry

Darkness: no street lighting

1067

Vehicle Reference 1 Car

Moving from N to S

Going ahead other

Casualty Reference: 1 Age: 22 Male

Driver/rider

Severity: Fatal

Injured by vehicle: 1

Vehicle Reference 2 Car

Moving from N to S

Going ahead other

Tuesday 06/05/2003 Time 1429 Slight at A43 AT RBT J/W SLIP RD TO M40 SBOUND AT J10 STOKE LYNE

E: 454773 N: 228413 Junction Detail: 1 Control 4

Fine without high winds Road surface Dry

Daylight:street lights present

1068

Vehicle Reference 1 Car

Moving from N to SE

Turning left

Casualty Reference: 1 Age: 27 Female

Passenger

Severity: Slight

Injured by vehicle: 1

Vehicle Reference 2 Goods 7.5 tonnes mgw and over

Moving from N to SW

Turning right

Saturday 24/05/2003 Time 0838 Slight at A43 AT RBT J/W ACCESS TO MOTO SERVICES AT J10 STOKE LYNE

E: 454784 N: 228153 Junction Detail: 1 Control 4

Fine without high winds Road surface Dry

Daylight:street lights present

1069

Vehicle Reference 1 Motor Cycle over 125 cc and up to 500cc

Moving from SW to NE

Changing lane to right

Casualty Reference: 1 Age: 21 Male

Driver/rider

Severity: Slight

Injured by vehicle: 1

Vehicle Reference 2 Car

Moving from SW to N

Turning left

Accidents between dates 01/08/2001 and 31/07/2006 (60) months

Selection: Notes:

Selected using Manual Selection

Wednesday 04/06/2003 Time 1915 Slight at A43 RBT J/W M40 SBOUND EXIT & ENTRY SLIP ROADS STOKE LYNE
E: 454781 N: 228418 Junction Detail: 1 Control 4
Fine without high winds Road surface Dry Daylight:street lights present

1070

Vehicle Reference 1 Goods 7.5 tonnes mgw and over

Moving from N to W Turning right

Vehicle Reference 2 Minibus

Moving from E to S Turning left

Casualty Reference: 1 Age: 30 Female Passenger Severity: Slight

Injured by vehicle: 2

Wednesday 18/06/2003 Time 1315 Slight at B430 OXFORD RD AT J/W B4030 BICESTER RD CROSSROADS MIDDLETON STONEY
E: 453422 N: 223499 Junction Detail: 6 Control 2
Fine without high winds Road surface Dry Daylight: no street lighting

1071

Vehicle Reference 1 Car

Moving from N to N Turning right

Vehicle Reference 2 Car

Moving from S to N Going ahead other

Casualty Reference: 1 Age: 60 Male Driver/rider Severity: Slight

Injured by vehicle: 2

Thursday 26/06/2003 Time 1915 Serious at B430 AT RBT J/W M40 NBOUND EXIT SLIP ROAD STOKE LYNE
E: 454538 N: 227916 Junction Detail: 1 Control 4
Fine without high winds Road surface Dry Daylight: no street lighting

1072

Vehicle Reference 1 Goods 7.5 tonnes mgw and over

Moving from SE to NE Turning right

Casualty Reference: 1 Age: 45 Male Driver/rider Severity: Serious

Injured by vehicle: 1

Friday 27/06/2003 Time 1713 Slight at B430 AT J/W UPPER HEYFORD ROAD ARDLEY
E: 453776 N: 225562 Junction Detail: 3 Control 4
Fine without high winds Road surface Wet/Damp Daylight: no street lighting

1073

Accidents between dates 01/08/2001 and 31/07/2006 (60) months

Selection: Notes:
Selected using Manual Selection

Vehicle Reference 1 Goods over 3.5 tonnes and under 7.5 tonnes mgw Moving from N to SW Turning right
 Vehicle Reference 2 Car Moving from SW to NE Going ahead other
 Casualty Reference: 1 Age: 26 Female Driver/rider Severity: Slight Injured by vehicle: 2
 Vehicle Reference 3 Goods over 3.5 tonnes and under 7.5 tonnes mgw Moving from NE to SW Going ahead other

~~Saturday 28/06/2003 Time 2015 Slight at M40 SOUTHBOUND JUST BEFORE J10 ARDLEY
 E: 454267 N: 228879 Junction Detail: 0 Control
 Fine without high winds Road surface Dry Daylight: no street lighting~~

~~Vehicle Reference 1 Car Moving from N to SE Going ahead other
 Casualty Reference: 1 Age: 18 Female Passenger Severity: Slight Injured by vehicle: 1~~

Thursday 03/07/2003 Time 1456 Slight at A4260 AT J/W STEEPLE ASTON TURN STEEPLE ASTON
 E: 446493 N: 225857 Junction Detail: 3 Control 4
 Fine without high winds Road surface Dry Daylight: no street lighting

1075

Vehicle Reference 1 Car Moving from S to E Turning right
 Vehicle Reference 2 Car Moving from N to S Going ahead other
 Casualty Reference: 1 Age: 43 Female Driver/rider Severity: Slight Injured by vehicle: 2
 Vehicle Reference 3 Car Moving from E to N Waiting to turn right

Tuesday 08/07/2003 Time 0935 Serious at A43 AT RBT J/W M40 NBOUND EXIT SLIP STOKE LYNE
 E: 454534 N: 227908 Junction Detail: 1 Control 4
 Fine without high winds Road surface Dry Daylight: street lights present

1076

Vehicle Reference 1 Goods 7.5 tonnes mgw and over Moving from SE to NE Turning right

Accidents between dates 01/08/2001 and 31/07/2006 (60) months

Selection: Notes:
Selected using Manual Selection

1

Monday 04/08/2003 Time 0230 Slight at A4260 NBOUND CWAY BETWEEN HOPCROFTS HOLT & DEDDINGTON OPPOSITE J/W ON SBOUND CWAY TO
E: 446380 N: 226920 Junction Detail: 0 Control
Unknown Road surface Dry Darkness: no street lighting
Vehicle Reference 1 Car Moving from S to N Going ahead other
Casualty Reference: 1 Age: 25 Male Driver/rider Severity: Slight Injured by vehicle: 1

2

Tuesday 12/08/2003 Time 1445 Slight at UPPER HEYFORD ROAD (BETWEEN B430 AND CAMP ROAD) ARDLEY (EXACT LOCATION UNCERTAIN)
E: 453063 N: 225787 Junction Detail: 0 Control
Fine without high winds Road surface Dry Daylight: no street lighting
Vehicle Reference 1 Goods 7.5 tonnes mgw and over Moving from W to E Going ahead other
Casualty Reference: 1 Age: 44 Male Driver/rider Severity: Slight Injured by vehicle: 1
Casualty Reference: 2 Age: 11 Male Passenger Severity: Slight Injured by vehicle: 1
Vehicle Reference 2 Goods 7.5 tonnes mgw and over Moving from E to W Going ahead other

3

Tuesday 19/08/2003 Time 1131 Slight at A43 AT RBT J/W M40 NBOUND EXIT SLIP ROAD AT J10 STOKE LYNE
E: 454532 N: 227901 Junction Detail: 1 Control 4
Fine without high winds Road surface Dry Daylight:street lights present
Vehicle Reference 1 Goods 7.5 tonnes mgw and over Moving from SE to NE Turning right
Casualty Reference: 1 Age: 40 Male Driver/rider Severity: Slight Injured by vehicle: 1

4

Friday 29/08/2003 Time 1645 Slight at A43 AT RBT J/W ACCESS TO CHERWELL VALLEY SERVICES STOKE LYNE
E: 454786 N: 228084 Junction Detail: 1 Control 4
Fine without high winds Road surface Dry Daylight:street lights present
Vehicle Reference 1 Goods 7.5 tonnes mgw and over Moving from N to W Turning right
Casualty Reference: 1 Age: 39 Male Driver/rider Severity: Slight Injured by vehicle: 1

Accidents between dates 01/08/2001 and 31/07/2006 (60) months

Selection: Notes:
Selected using Manual Selection

Tuesday 07/10/2003 Time 1403 Slight at B4030 BICESTER RD OUTSIDE RIGELETTO'S RESTAURANT MIDDLETON STONEY
E: 453803 N: 223499 Junction Detail: 8 Control 4
Fine without high winds Road surface Dry Daylight: no street lighting
Vehicle Reference 1 Goods 3.5 tonnes mgw and under Moving from W to E Going ahead other
Vehicle Reference 2 Car Moving from W to E Stopping
Casualty Reference: 1 Age: 58 Male Driver/rider Severity: Slight

5

Injured by vehicle: 2

Wednesday 15/10/2003 Time 0828 Slight at A4260 AT NORTH ASTON / DUNS TEW RD CROSSROADS NORTH ASTON
E: 446945 N: 228667 Junction Detail: 3 Control 4
Fine without high winds Road surface Dry Daylight: no street lighting
Vehicle Reference 1 Car Moving from N to W Turning right
Vehicle Reference 2 Motor Cycle over 125 cc and up to 500cc Moving from S to N Going ahead other
Casualty Reference: 1 Age: 42 Male Driver/rider Severity: Slight

6

Injured by vehicle: 2

Monday 03/11/2003 Time 0024 Slight at A4260 NBOUND CWAY AT DUNS TEW DUAL CWAY SECTION MIDDLE ASTON
E: 446411 N: 227196 Junction Detail: 0 Control
Fine without high winds Road surface Wet/Damp Darkness: no street lighting
Vehicle Reference 1 Car Moving from S to N Going ahead other
Casualty Reference: 1 Age: 33 Female Driver/rider Severity: Slight

9

Injured by vehicle: 1

Accidents between dates 01/08/2001 and 31/07/2006 (60) months

Selection: Notes:
Selected using Manual Selection

Saturday 08/11/2003 Time 1220 Serious at B430 AT J/W ENTRANCE TO ARDLEY TIP & QUARRY ARDLEY
E: 453972 N: 226329 Junction Detail: 3 Control 4
Fine without high winds Road surface Dry Daylight: no street lighting
Vehicle Reference 1 Car Moving from SW to SE Turning right

10

| | | | | | |
|-------------------------|---------|--------|----------------------|-------------------|-----------------------|
| Casualty Reference: 1 | Age: 52 | Female | Passenger | Severity: Serious | Injured by vehicle: 1 |
| Vehicle Reference 2 Car | | | Moving from NE to SW | Going ahead other | |
| Casualty Reference: 2 | Age: 77 | Male | Passenger | Severity: Slight | Injured by vehicle: 2 |
| Casualty Reference: 3 | Age: 68 | Male | Passenger | Severity: Slight | Injured by vehicle: 2 |
| Casualty Reference: 4 | Age: 58 | Female | Passenger | Severity: Slight | Injured by vehicle: 2 |

Sunday 23/11/2003 Time 1943 Slight at A43 AT RBT J/W M40 SOUTHBOUND STOKE LYNE
E: 454775 N: 228476 Junction Detail: 1 Control 4
Raining without high winds Road surface Wet/Damp Darkness: street lights present and lit
Vehicle Reference 1 Car Moving from N to S Going ahead other
Vehicle Reference 2 Car Moving from N to S Going ahead but held up

11

| | | | | | |
|-----------------------|---------|--------|--------------|------------------|-----------------------|
| Casualty Reference: 1 | Age: | Female | Passenger | Severity: Slight | Injured by vehicle: 2 |
| Casualty Reference: 2 | Age: 26 | Female | Driver/rider | Severity: Slight | Injured by vehicle: 2 |

Monday 24/11/2003 Time 1105 Serious at SOMERTON RD APPROX 400M W OF TROY COTTAGES SOMERTON
E: 451257 N: 228144 Junction Detail: 0 Control
Fine without high winds Road surface Wet/Damp Daylight: no street lighting
Vehicle Reference 1 Car Moving from W to SE Going ahead right bend

12

| | | | | | |
|-----------------------|---------|--------|--------------|-------------------|-----------------------|
| Casualty Reference: 1 | Age: 57 | Female | Driver/rider | Severity: Serious | Injured by vehicle: 1 |
|-----------------------|---------|--------|--------------|-------------------|-----------------------|

Accidents between dates **01/08/2001 and 31/07/2006** (60) months

Selection: **Notes:**
 Selected using Manual Selection

| | | | | | | | | |
|----------------------------|------------|------------------|----------|---------|----|------------------------------|-----------------------|-----------------------|
| Saturday | 29/11/2003 | Time | 1045 | Slight | at | A4260 AT J/W FENWAY | STEEPLE ASTON | 13 |
| E: 446454 | N: 226258 | Junction Detail: | 3 | Control | 4 | | | |
| Raining without high winds | | Road surface | Wet/Damp | | | Daylight: no street lighting | | |
| Vehicle Reference 1 | Car | | | | | Moving from S to N | Going ahead other | |
| Casualty Reference: | 1 | Age: | 21 | Male | | Driver/rider | Severity: Slight | Injured by vehicle: 1 |
| Vehicle Reference 2 | Car | | | | | Moving from S to E | Waiting to turn right | |
| Casualty Reference: | 2 | Age: | 56 | Male | | Driver/rider | Severity: Slight | Injured by vehicle: 2 |

| | | | | | | | | |
|-------------------------|------------|------------------|------|---------|----|-------------------------------------|---------------------|-----------------------|
| Saturday | 13/12/2003 | Time | 2021 | Serious | at | A4260 JUNCTION B4030 HOPCROFT HOLT, | STEEPLE ASTON, OXON | 16 |
| E: 446530 | N: 225065 | Junction Detail: | 6 | Control | 2 | | | |
| Fine without high winds | | Road surface | Dry | | | Darkness: no street lighting | | |
| Vehicle Reference 1 | Car | | | | | Moving from E to N | Turning right | |
| Casualty Reference: | 1 | Age: | 28 | Female | | Driver/rider | Severity: Serious | Injured by vehicle: 1 |
| Vehicle Reference 2 | Car | | | | | Moving from N to S | Going ahead other | |

| | | | | | | | | | |
|-------------------------|------------|------------------|-----------|---------|----|--|-------------------|-----------------------|-----------|
| Saturday | 17/01/2004 | Time | 1044 | Slight | at | B430 AT RAILWAY BRIDGE APPROX 400M SW OF | ARDLEY TIP | ARDLEY | 17 |
| E: 454093 | N: 226724 | Junction Detail: | 0 | Control | | | | | |
| Fine without high winds | | Road surface | Frost/Ice | | | Daylight:street lights present | | | |
| Vehicle Reference 1 | Car | | | | | Moving from SW to NE | Going ahead other | | |
| Casualty Reference: | 1 | Age: | 31 | Male | | Driver/rider | Severity: Slight | Injured by vehicle: 1 | |

| | | | | | | | | | |
|---------------------|------------|------------------|-------|---------|----|---|------------------------|-----------------------|-----------|
| Wednesday | 28/01/2004 | Time | 1800 | Slight | at | B4030 HEYFORD RD AT BEND APPROX 450M W OF J/W | CAMP ROAD | MIDDLETON | 18 |
| STONEY | | | | | | | | | |
| E: 452035 | N: 224360 | Junction Detail: | 0 | Control | | | | | |
| Unknown | | Road surface | Flood | | | Darkness: no street lighting | | | |
| Vehicle Reference 1 | Car | | | | | Moving from NW to E | Going ahead left bend | | |
| Casualty Reference: | 1 | Age: | 18 | Male | | Passenger | Severity: Slight | Injured by vehicle: 1 | |
| Vehicle Reference 2 | Car | | | | | Moving from E to NW | Going ahead right bend | | |
| Casualty Reference: | 2 | Age: | 39 | Male | | Driver/rider | Severity: Slight | Injured by vehicle: 2 | |

Accidents between dates 01/08/2001 and 31/07/2006 (60) months

Selection: Notes:
Selected using Manual Selection

Friday 16/01/2004 Time 1745 Slight at A43 - PROBABLY AT RBT J/W M40 SBOUND ENTRY / EXIT SLIP ROAD STOKE LYNE

E: 454753 N: 228478 Junction Detail: 1 Control 4

Fine without high winds Road surface Dry

Vehicle Reference 1 Goods 7.5 tonnes mgw and over

Vehicle Reference 2 Taxi/Private hire car

Casualty Reference: 1 Age: 40 Male

Darkness: street lights present and lit

Moving from S to N

Moving from S to N

Driver/rider

Changing lane to left

Going ahead other

Severity: Slight

Injured by vehicle: 2

19

Sunday 28/03/2004 Time 1057 Serious at A43 / M40 J 10 - PROBABLY AT ROUNDABOUT J/W CHERWELL VALLEY SERVICES BUT SOME UNCERTAIN

E: 454811 N: 228153 Junction Detail: 1 Control 4

Fine without high winds Road surface Wet/Damp

Vehicle Reference 1 Motor Cycle over 125 cc and up to 500cc

Casualty Reference: 1 Age: 23 Male

Daylight:street lights present

Moving from N to SW

Driver/rider

Going ahead right bend

Severity: Serious

Injured by vehicle: 1

21

Wednesday 31/03/2004 Time 2116 Serious at HEYFORD ROAD AT BEND A PPROX 250M N OF B4030 STEEPLE ASTON

E: 447858 N: 225015 Junction Detail: 0 Control

Fine without high winds Road surface Dry

Vehicle Reference 1 Car

Casualty Reference: 1 Age: 18 Male

Darkness: no street lighting

Moving from NW to S

Driver/rider

Going ahead right bend

Severity: Serious

Injured by vehicle: 1

22

Accidents between dates 01/08/2001 and 31/07/2006 (60) months

Selection: Notes:
Selected using Manual Selection

23

Tuesday 06/04/2004 Time 1852 Slight at A4260 AT J/W ACCESS TO GARAGE ON W SIDE O F ROAD JUST N OF J/W B4030 AT HOPCROFTS HOLT STE
E: 446522 N: 225128 Junction Detail: 8 Control 4
Fine without high winds Road surface Dry Daylight: no street lighting
Vehicle Reference 1 Car Moving from W to S Turning right
Vehicle Reference 2 Car Moving from N to S Going ahead other
Casualty Reference: 1 Age: 48 Female Driver/rider Severity: Slight Injured by vehicle: 2
Casualty Reference: 2 Age: 16 Female Passenger Severity: Slight Injured by vehicle: 2

Tuesday 13/04/2004 Time 1116 Slight at A43 AT RBT J/W M40 NBORND EXIT SLIP ROAD & B430 STOKE LYNE
E: 454531 N: 227904 Junction Detail: 1 Control 4
Fine without high winds Road surface Dry Daylight: street lights present
Vehicle Reference 1 Goods 7.5 tonnes mgw and over Moving from SE to NE Turning right
Casualty Reference: 1 Age: 49 Male Driver/rider Severity: Slight Injured by vehicle: 1

Wednesday 21/04/2004 Time 1620 Slight at A4260 STEEPLE ASTON J/W ENTRANCE TO BRASENOSE FARM STEEPLE ASTON
E: 446442 N: 226343 Junction Detail: 8 Control 4
Raining without high winds Road surface Wet/Damp Daylight: no street lighting
Vehicle Reference 1 Car Moving from S to W Turning left
Vehicle Reference 2 Car Moving from S to N Going ahead other
Vehicle Reference 3 Motor Cycle over 50 cc and up to 125cc Moving from S to N Going ahead other
Casualty Reference: 1 Age: 18 Male Driver/rider Severity: Slight Injured by vehicle: 3

26

Accidents between dates 01/08/2001 and 31/07/2006 (60) months

Selection: Notes:

Selected using Manual Selection

Thursday 22/04/2004 Time 1228 Slight at A43 AT RBT AT J/W CHERWELL VALLEY SERVICES STOKE LYNE

E: 454787 N: 228150 Junction Detail: 1 Control 4
 Fine without high winds Road surface Dry Daylight:street lights present
 Vehicle Reference 1 Car Moving from SW to N Turning left
 Casualty Reference: 1 Age: 53 Male Driver/rider Severity: Slight
 Vehicle Reference 2 Goods over 3.5 tonnes and under 7.5 tonnes mgw Moving from SW to SE Turning right

27

Injured by vehicle: 1

28

Tuesday 27/04/2004 Time 1500 Slight at MIDDLE ASTON ROAD20 M N OF XRDS J/W ROAD TO WARREN FARM & GRANGE FARM MIDDLE ASTON

E: 447466 N: 227861 Junction Detail: 0 Control
 Fine without high winds Road surface Dry Daylight: no street lighting
 Vehicle Reference 1 Car Moving from SW to NW Going ahead left bend
 Vehicle Reference 2 Car Moving from NW to SE Going ahead other
 Casualty Reference: 1 Age: 54 Male Driver/rider Severity: Slight

Injured by vehicle: 2

31

Friday 07/05/2004 Time 0532 Serious at A4260 BANBURY TO KIDLINGTON RD JUST SOUTH OF TURNING TO STEEPLE ASTON NEAR BRASENOSE F

E: 446459 N: 226247 Junction Detail: 3 Control 4
 Fine without high winds Road surface Dry Daylight: no street lighting
 Vehicle Reference 1 Goods 3.5 tonnes mgw and under Moving from NW to S Going ahead right bend
 Casualty Reference: 1 Age: 41 Male Driver/rider Severity: Serious

Injured by vehicle: 1

32

Wednesday 26/05/2004 Time 2003 Slight at A43 RBT J/W SBOUND ENTRY AND EXIT SLIP ROADS ARDLEY

E: 454756 N: 228484 Junction Detail: 1 Control 4
 Fine without high winds Road surface Dry Daylight:street lights present
 Vehicle Reference 1 Goods 7.5 tonnes mgw and over Moving from S to N Going ahead other
 Casualty Reference: 1 Age: 46 Male Driver/rider Severity: Slight

Injured by vehicle: 1

Accidents between dates 01/08/2001 and 31/07/2006 (60) months

Selection: Notes:

Selected using Manual Selection

Tuesday 08/06/2004 Time 1718 Serious at A43 AT RBT J/W M40 SBOUND ENTRY & EXIT SLIP ROADS STOKE LYNE

E: 454776 N: 228409 Junction Detail: 1 Control 4

Fine without high winds Road surface Dry

Vehicle Reference 1 Car

Vehicle Reference 2 Motor Cycle over 125 cc and up to 500cc

Casualty Reference: 1 Age: 57 Male

Daylight:street lights present

Moving from N to S

Moving from N to W

Driver/rider

Going ahead other

Turning right

Severity: Serious

33

Injured by vehicle: 2

Saturday 12/06/2004 Time 0558 Slight at A43 AT RBT J/W M40 NBOUND EXIT SLIP & B430 STOKE LYNE

E: 454534 N: 227911 Junction Detail: 1 Control 4

Fine without high winds Road surface Dry

Vehicle Reference 1 Goods 7.5 tonnes mgw and over

Casualty Reference: 1 Age: 30 Male

Daylight:street lights present

Moving from SE to NE

Driver/rider

Turning right

Severity: Slight

34

Injured by vehicle: 1

Thursday 10/06/2004 Time 0758 Serious at A43 AT RBT J/W CHERWELL VALLEY SERVICES & M40 SBOUND ENTRY SLIP STOKE LYNE

E: 454815 N: 228156 Junction Detail: 1 Control 4

Fine without high winds Road surface Dry

Vehicle Reference 1 Motor Cycle over 125 cc and up to 500cc

Casualty Reference: 1 Age: 24 Male

Daylight:street lights present

Moving from NW to S

Driver/rider

Going ahead right bend

Severity: Serious

35

Injured by vehicle: 1

Friday 18/06/2004 Time 1325 Slight at B430 AT BEND APPROX 500M S OF J/W B4030 MIDDLETON STONEY

E: 453443 N: 223097 Junction Detail: 0 Control

Fine without high winds Road surface Dry

Vehicle Reference 1 Car

Casualty Reference: 1 Age: 58 Female

Daylight: no street lighting

Moving from NE to S

Driver/rider

Going ahead left bend

Severity: Slight

36

Injured by vehicle: 1

Vehicle Reference 2 Car

Moving from S to NE

Going ahead right bend

Vehicle Reference 3 Car

Moving from S to NE

Going ahead right bend

Monday 05/07/2004 Time 1126 Slight at A43 RBT J/W CHERWELL VALLEY SERVICES STOKE LYNE
E: 454783 N: 228149 Junction Detail: 1 Control 4 (60) months

38

Accidents between dates 01/08/2001 and 31/07/2006
Selection: Fine without high winds Road surface Dry Notes: Daylight:street lights present
Selected using Main Ref Selection Goods 7.5 tonnes mgw and over Moving from SW to SE Turning right
Vehicle Reference 1 Car Moving from W to NE Turning left
Vehicle Reference 2 Car Driver/rider Severity: Slight
Casualty Reference: 1 Age: 35 Female Injured by vehicle: 2

Thursday 08/07/2004 Time 1510 Slight at A43 RBT J/W B430 AND M40 NBOUND EXIT / ENTRY SLIP ROAD STOKE LYNE
E: 454576 N: 227925 Junction Detail: 1 Control 4

39

Fine without high winds Road surface Dry Daylight:street lights present
Vehicle Reference 1 Car Moving from W to NE Turning left
Casualty Reference: 1 Age: 63 Female Passenger Severity: Slight Injured by vehicle: 1
Vehicle Reference 2 Goods 7.5 tonnes mgw and over Moving from W to SE Turning right

Wednesday 21/07/2004 Time 1557 Slight at A43 NBOUND APPROX 50M N OF RBT J/W M40 J10 / CHERWELL VALLEY SERVICES STOKE LYNE
E: 454793 N: 228203 Junction Detail: 0 Control

41

Fine without high winds Road surface Dry Daylight:street lights present
Vehicle Reference 1 Goods 7.5 tonnes mgw and over Moving from S to N Changing lane to left
Vehicle Reference 2 Car Moving from S to N Going ahead other
Casualty Reference: 1 Age: 72 Female Passenger Severity: Slight Injured by vehicle: 2

Friday 23/07/2004 Time 0743 Slight at A43 RBT J/W M40 NBOUND EXIT SLIP ROAD & B430 STOKE LYNE
E: 454534 N: 227904 Junction Detail: 1 Control 4

42

Fine without high winds Road surface Dry Daylight:street lights present
Vehicle Reference 1 Goods 7.5 tonnes mgw and over Moving from SE to NE Turning right
Casualty Reference: 1 Age: 51 Male Driver/rider Severity: Slight Injured by vehicle: 1

Wednesday 11/08/2004 Time 1855 Slight at A43 AT RBT J/W M40 SBOUND SLIP ROADS STOKE LYNE
E: 454720 N: 228433 Junction Detail: 1 Control 4

44

Fine without high winds Road surface Dry Daylight:street lights present
Vehicle Reference 1 Goods 7.5 tonnes mgw and over Moving from NE to W Going ahead right bend
Casualty Reference: 1 Age: 54 Male Driver/rider Severity: Slight Injured by vehicle: 1
Vehicle Reference 2 Car Moving from NE to W Going ahead right bend

Accidents between dates 01/08/2001 and 31/07/2006 (60) months

Selection: Notes:

Selected using Manual Selection

Friday 20/08/2004 Time 1845 Slight at CAMP ROAD AT BEND BY J/W ARDLEY ROAD MIDDLETON STONEY
 E: 452178 N: 225668 Junction Detail: 3 Control 4
 Fine without high winds Road surface Wet/Damp Daylight: no street lighting
 Vehicle Reference 1 Car Moving from SE to W Going ahead left bend
 Casualty Reference: 1 Age: 36 Male Driver/rider Severity: Slight Injured by vehicle: 1
 Vehicle Reference 2 Car Moving from W to SE Going ahead right bend

45

Wednesday 13/10/2004 Time 1530 Slight at A43 J/W M40 ON CHERWELL SERVICES RBT STOKE LYNE
 E: 454779 N: 228145 Junction Detail: 1 Control 4
 Fine without high winds Road surface Dry Daylight: street lights present
 Vehicle Reference 1 Goods 7.5 tonnes mgw and over Moving from SW to E Turning right
 Vehicle Reference 2 Car Moving from SW to NW Turning left
 Casualty Reference: 1 Age: 40 Male Driver/rider Severity: Slight Injured by vehicle: 2

49

Wednesday 13/10/2004 Time 1548 Slight at B430 AT BEND APPROX 600M NW OF J/W B430 MIDDLETON STONEY
 E: 452935 N: 223830 Junction Detail: 0 Control
 Raining without high winds Road surface Wet/Damp Daylight: no street lighting
 Vehicle Reference 1 Car Moving from NW to E Going ahead left bend
 Casualty Reference: 1 Age: 43 Male Driver/rider Severity: Slight Injured by vehicle: 1
 Vehicle Reference 2 Car Moving from E to NW Going ahead right bend

51

Wednesday 20/10/2004 Time 1425 Slight at A43 AT RBT J/W M40 / CHERWELL VALLEY SERVICES STOKE LYNE
 E: 454786 N: 228152 Junction Detail: 1 Control 4
 Raining without high winds Road surface Wet/Damp Daylight: street lights present
 Vehicle Reference 1 Goods 7.5 tonnes mgw and over Moving from SW to SE Going ahead right bend
 Vehicle Reference 2 Car Moving from SW to N Turning left
 Casualty Reference: 1 Age: 26 Female Driver/rider Severity: Slight Injured by vehicle: 2

52

Accidents between dates 01/08/2001 and 31/07/2006 (60) months

Selection: Notes:
Selected using Manual Selection

Thursday 11/11/2004 Time 0830 Slight at B4030 AT J/W CAMP ROAD MIDDLETON STONEY
E: 452494 N: 224425 Junction Detail: 3 Control 4
Fine without high winds Road surface Dry Daylight: no street lighting
Vehicle Reference 1 Car Moving from SE to N Turning right
Vehicle Reference 2 Car Moving from SW to SE Going ahead right bend
Casualty Reference: 1 Age: 25 Female Driver/rider Severity: Slight Injured by vehicle: 2

54

Wednesday 01/12/2004 Time 1650 Slight at A4260 J/W B4030 AT HOPCROFTS HOLT STEEPLE BARTON
E: 446528 N: 225059 Junction Detail: 3 Control 2
Fine without high winds Road surface Wet/Damp Darkness: no street lighting
Vehicle Reference 1 Car Moving from S to E Turning right
Casualty Reference: 1 Age: 18 Female Driver/rider Severity: Slight Injured by vehicle: 1
Vehicle Reference 2 Car Moving from N to S Going ahead other

55

Sunday 12/12/2004 Time 0007 Slight at B4030 AT J/W KIRTLINGTON RD (PORTWAY) LOWER HEYFORD
E: 449985 N: 224437 Junction Detail: 3 Control 4
Fine without high winds Road surface Dry Darkness: no street lighting
Vehicle Reference 1 Car Moving from S to E Turning right
Casualty Reference: 1 Age: 70 Female Driver/rider Severity: Slight Injured by vehicle: 1
Vehicle Reference 2 Car Moving from E to W Going ahead other
Casualty Reference: 2 Age: 41 Female Driver/rider Severity: Slight Injured by vehicle: 2

56

Tuesday 08/02/2005 Time 1735 Slight at A4260 AT J/W ACCESS TO GARAGE ON W SIDE OF ROAD JUST N OF J/W B4030 AT HOPCROFTS HOLT STE
E: 446521 N: 225124 Junction Detail: 6 Control 2
Fine without high winds Road surface Dry Darkness: no street lighting
Vehicle Reference 1 Car Moving from S to N Going ahead other
Casualty Reference: 1 Age: 55 Male Driver/rider Severity: Slight Injured by vehicle: 1

59

Accidents between dates 01/08/2001 and 31/07/2006 (60) months

Selection: Notes:

Selected using Manual Selection

Saturday 12/02/2005 Time 1726 Slight at B430 OXFORD RD AT J/W B4030 BICESTER RD CROSS ROADS MIDDLETON STONEY
E: 453431 N: 223479 Junction Detail: 6 Control 2

60

Fine with high winds Road surface Wet/Damp Darkness: street lights present and lit
Vehicle Reference 1 Car Moving from N to E Turning left
Casualty Reference: 1 Age: 13 Male Passenger Severity: Slight Injured by vehicle: 1
Vehicle Reference 2 Car Moving from E to NW Going ahead other

Friday 04/03/2005 Time 1525 Slight at A43 AT RBT J/W CHERWELL VALLEY SERVICES & M40 SBOUND ENTRY SLIP STOKE LYNE
E: 454811 N: 228144 Junction Detail: 1 Control 4

61

Fine without high winds Road surface Wet/Damp Daylight:street lights present
Vehicle Reference 1 Motorcycle over 500cc Moving from N to S Stopping
Casualty Reference: 1 Age: 33 Male Driver/rider Severity: Slight Injured by vehicle: 1

Monday 07/03/2005 Time 1029 Slight at A43 AT RBT J/W ACCESS TO CHERWELL VALLEY SERVICES STOKE LYNE
E: 454790 N: 228087 Junction Detail: 1 Control 4

62

Fine without high winds Road surface Dry Daylight:street lights present
Vehicle Reference 1 Goods 3.5 tonnes mgw and under Moving from N to SW Turning right
Casualty Reference: 1 Age: 19 Male Driver/rider Severity: Slight Injured by vehicle: 1

Monday 28/03/2005 Time 1050 Slight at B4030 BICESTER RD APPROX 35M W OF J/W BUCKNELL LODGE MIDDLETON STONEY
E: 454019 N: 223498 Junction Detail: 0 Control

65

Fine without high winds Road surface Dry Daylight: no street lighting
Vehicle Reference 1 Other motor vehicle Moving from E to W Going ahead other
Vehicle Reference 2 Car Moving from E to 0 Parked
Casualty Reference: 1 Age: 42 Female Driver/rider Severity: Slight Injured by vehicle: 2
Casualty Reference: 2 Age: 36 Male Passenger Severity: Slight Injured by vehicle: 2

Accidents between dates 01/08/2001 and 31/07/2006 (60) months

Selection:

Notes:

Selected using Manual Selection

Thursday 07/04/2005 Time 1210 Slight at A43 RBT J/W M40 SBOUND EXIT & ENTRY SLIP ROADS STOKE LYNE
 E: 454788 N: 228419 Junction Detail: 1 Control 4
 Fine without high winds Road surface Dry Daylight:street lights present
 Vehicle Reference 1 Goods 7.5 tonnes mgw and over Moving from N to S Going ahead other
 Casualty Reference: 1 Age: 42 Male Driver/rider Severity: Slight

67

Injured by vehicle: 1

Wednesday 27/04/2005 Time 0946 Slight at A43 AT RBT J/W M40 / CHERWELL VALLEY SERVICES STOKE LYNE
 E: 454788 N: 228153 Junction Detail: 1 Control 4
 Fine without high winds Road surface Dry Daylight:street lights present
 Vehicle Reference 1 Goods 7.5 tonnes mgw and over Moving from W to SE Turning right
 Vehicle Reference 2 Car Moving from W to N Going ahead other
 Casualty Reference: 1 Age: 47 Female Driver/rider Severity: Slight

69

Injured by vehicle: 2

Sunday 08/05/2005 Time 1005 Serious at A43 AT RBT J/W CHERWELL VALLEY SERVICES STOKE LYNE
 E: 454816 N: 228162 Junction Detail: 1 Control 4
 Fine without high winds Road surface Dry Daylight:street lights present
 Vehicle Reference 1 Motor Cycle over 50 cc and up to 125cc Moving from NW to S Going ahead right bend
 Casualty Reference: 1 Age: 46 Male Driver/rider Severity: Serious

71

Injured by vehicle: 1

Wednesday 08/06/2005 Time 1810 Slight at A43 RBT J/W M40 NBOUND EXIT SLIP ROAD AND B430 STOKE LYNE
 E: 454530 N: 227897 Junction Detail: 1 Control 4
 Fine without high winds Road surface Dry Daylight:street lights present
 Vehicle Reference 1 Goods 7.5 tonnes mgw and over Moving from SE to N Turning right
 Casualty Reference: 1 Age: 32 Male Driver/rider Severity: Slight

72

Injured by vehicle: 1

Accidents between dates 01/08/2001 and 31/07/2006 (60) months

Selection: Notes:
Selected using Manual Selection

Sunday 12/06/2005 Time 1751 Slight at A43 AT RBT J/W SOUTHBOUND ENTRY & EXIT SLIP ROADS STOKE LYNE
E: 454717 N: 228436 Junction Detail: 1 Control 4
Fine without high winds Road surface Dry Daylight:street lights present
Vehicle Reference 1 Motorcycle over 500cc Moving from SE to W Going ahead left bend
Casualty Reference: 1 Age: 40 Female Passenger Severity: Slight

73

Injured by vehicle: 1

75

Tuesday 07/06/2005 Time 1940 Serious at A4260 NBOUND CWAY AT DUNS TEW DUAL CARRIAGEWAY APPROX 350M S OF DUNS TEW TURN MIDD
E: 446447 N: 227293 Junction Detail: 0 Control
Fine without high winds Road surface Dry Daylight: no street lighting
Vehicle Reference 1 Car Moving from S to NE Going ahead right bend
Casualty Reference: 1 Age: 51 Female Driver/rider Severity: Serious

Injured by vehicle: 1

79

Friday 12/08/2005 Time 2000 Slight at WATER STREET BY OLD INN ADJACENT TO THE DELL SOMERTON
E: 449683 N: 228937 Junction Detail: 0 Control
Fine without high winds Road surface Dry Daylight: no street lighting
Vehicle Reference 1 Car Moving from SE to N Going ahead right bend
Casualty Reference: 1 Age: 29 Male Driver/rider Severity: Slight
Casualty Reference: 2 Age: 32 Male Passenger Severity: Slight
Casualty Reference: 3 Age: 39 Male Passenger Severity: Slight

Injured by vehicle: 1

Injured by vehicle: 1

Injured by vehicle: 1

Accidents between dates 01/08/2001 and 31/07/2006 (60) months

Selection: Notes:
Selected using Manual Selection

Friday 02/09/2005 Time 1023 Slight at A43 AT RBT J/W SLIP RD TO M40 SBOUND AT J10 STOKE LYNE
E: 454760 N: 228398 Junction Detail: 1 Control 4
Fine without high winds Road surface Dry Daylight:street lights present
Vehicle Reference 1 Car Moving from S to N Going ahead other
Casualty Reference: 1 Age: 82 Female Passenger Severity: Slight
Vehicle Reference 2 Car Moving from S to N Going ahead but held up

80

Injured by vehicle: 1

Monday 26/09/2005 Time 1316 Slight at A43 AT RBT J/W M40 / CHERWELL VALLEY SERVICES STOKE LYNE
E: 454789 N: 228156 Junction Detail: 1 Control 4
Fine without high winds Road surface Wet/Damp Daylight:street lights present
Vehicle Reference 1 Car Moving from S to E Turning right
Casualty Reference: 1 Age: 85 Male Driver/rider Severity: Slight
Vehicle Reference 2 Car Moving from S to N Going ahead other

82

Injured by vehicle: 1

Wednesday 21/09/2005 Time 2009 Slight at CAMP RD J/W GATE 8 (CHECK LOCATION PLOTTED) UPPER HEYFORD
E: 451246 N: 225795 Junction Detail: 3 Control 4
Fine without high winds Road surface Dry Darkness: street lights present and lit
Vehicle Reference 1 Car Moving from N to W Turning right
Vehicle Reference 2 Motorcycle 50cc and under Moving from W to E Going ahead other
Casualty Reference: 1 Age: 16 Male Driver/rider Severity: Slight

83

Injured by vehicle: 2

Accidents between dates 01/08/2001 and 31/07/2006 (60) months

Selection: Notes:
Selected using Manual Selection

Tuesday 20/09/2005 Time 1615 Slight at SOMERTON RD APPROX 315M SW OF FRITWELL VILLAGE FRITWELL
E: 451967 N: 229243 Junction Detail: 0 Control
Fine without high winds Road surface Dry Daylight: no street lighting
Vehicle Reference 1 Goods 7.5 tonnes mgw and over Moving from NE to SW Starting
Vehicle Reference 2 Pedal Cycle Moving from SW to NE Starting
Casualty Reference: 1 Age: 42 Male Driver/rider Severity: Slight

84

Injured by vehicle: 2

Tuesday 04/10/2005 Time 1700 Slight at B430 AT J/W ENTRANCE TO ARDLEY TIP & QUARRY ARDLEY
E: 453988 N: 226411 Junction Detail: 3 Control 4
Fine without high winds Road surface Dry Daylight: no street lighting
Vehicle Reference 1 Goods over 3.5 tonnes and under 7.5 tonnes mgw Moving from SE to NW Going ahead other
Vehicle Reference 2 Car Moving from SE to NW Going ahead other
Casualty Reference: 1 Age: 37 Female Driver/rider Severity: Slight

86

Injured by vehicle: 2

Saturday 08/10/2005 Time 0244 Slight at A43 AT RBT J/W M40 NBORND EXIT SLIP ROAD & B430 STOKE LYNE
E: 454527 N: 227899 Junction Detail: 1 Control 4
Fine without high winds Road surface Dry Darkness: street lights present and lit
Vehicle Reference 1 Goods 7.5 tonnes mgw and over Moving from SE to NE Going ahead right bend
Casualty Reference: 1 Age: 34 Male Driver/rider Severity: Slight

88

Injured by vehicle: 1

Accidents between dates 01/08/2001 and 31/07/2006 (60) months

Selection: Notes:
Selected using Manual Selection

Saturday 15/10/2005 Time 2244 Slight at ARDLEY ROAD APPROX 1250M NW OF B430 ARDLEY
E: 453545 N: 228299 Junction Detail: 0 Control
Fine without high winds Road surface Dry Darkness: no street lighting
Vehicle Reference 1 Car Moving from NW to SE Going ahead other
Casualty Reference: 1 Age: 46 Male Driver/rider Severity: Slight

89

Injured by vehicle: 1

Thursday 13/10/2005 Time 1112 Slight at A43 RBT J/W A43 & CHERWELL VALLEY SERVICES STOKE LYNE
E: 454777 N: 228150 Junction Detail: 1 Control 4
Fine without high winds Road surface Dry Daylight:street lights present
Vehicle Reference 1 Goods 7.5 tonnes mgw and over Moving from SW to NE Going ahead other
Vehicle Reference 2 Car Moving from SW to N Turning left
Casualty Reference: 1 Age: 39 Female Driver/rider Severity: Slight

90

Injured by vehicle: 2

Thursday 23/06/2005 Time 1232 Slight at A43 AT RBT J/W ACCESS TO MOTO SERVICES AT J10 STOKE LYNE
E: 454781 N: 228150 Junction Detail: 1 Control 4
Fine without high winds Road surface Dry Daylight:street lights present
Vehicle Reference 1 Goods 7.5 tonnes mgw and over Moving from SW to NE Changing lane to right
Vehicle Reference 2 Car Moving from SW to NE Changing lane to left
Casualty Reference: 1 Age: 61 Male Passenger Severity: Slight
Casualty Reference: 2 Age: 85 Female Passenger Severity: Slight
Casualty Reference: 3 Age: 59 Female Passenger Severity: Slight

91

Injured by vehicle: 2
Injured by vehicle: 2
Injured by vehicle: 2

Accidents between dates 01/08/2001 and 31/07/2006 (60) months

Selection: Notes:
Selected using Manual Selection

Thursday 03/11/2005 Time 1053 Slight at B430 J/W B4030 BICESTER ROAD MIDDLETON STONEY
 E: 453435 N: 223471 Junction Detail: 3 Control 2
 Fine without high winds Road surface Dry Daylight:street lights present
 Vehicle Reference 1 Car Moving from S to E Turning right
 Vehicle Reference 2 Car Moving from N to S Going ahead other
 Casualty Reference: 1 Age: 70 Female Passenger Severity: Slight

92

Injured by vehicle: 2

Saturday 26/11/2005 Time 1116 Slight at B4030 BEND JUST E OF LIME HOLLOW LOWER HEYFORD
 E: 451834 N: 224579 Junction Detail: 0 Control
 Fine without high winds Road surface Dry Daylight: no street lighting
 Vehicle Reference 1 Car Moving from SW to SE Going ahead right bend
 Casualty Reference: 1 Age: 9 Female Passenger Severity: Slight

96

Injured by vehicle: 1

Wednesday 28/12/2005 Time 1340 Slight at A43 APPROX 80M S OF RBT J/WM40 SBOUND ENTRY / EXIT SLIP ROADS ARDLEY
 E: 454779 N: 228343 Junction Detail: 0 Control
 Fine without high winds Road surface Wet/Damp Daylight:street lights present
 Vehicle Reference 1 Car Moving from N to S Going ahead other
 Casualty Reference: 2 Age: 73 Female Driver/rider Severity: Slight
 Vehicle Reference 2 Car Moving from N to S Going ahead other
 Casualty Reference: 1 Age: 32 Female Driver/rider Severity: Slight

100

Injured by vehicle: 1

Injured by vehicle: 2

Accidents between dates 01/08/2001 and 31/07/2006 (60) months

Selection: Notes:

Selected using Manual Selection

| | | | | | | | |
|-------------------------|------------|--------------------|-----------|--------------|--------------------------------------|------------------------------|-----------------------|
| Wednesday | 15/03/2006 | Time 0643 | Slight | at | CAMP ROAD AT BEND BY J/W ARDLEY ROAD | MIDDLETON STONEY | 108 |
| E: 452175 | N: 225669 | Junction Detail: 3 | Control 4 | | | | |
| Fine without high winds | | | | Road surface | Dry | Daylight: no street lighting | |
| Vehicle Reference 1 | Car | | | | Moving from NE to W | Turning right | |
| Vehicle Reference 2 | Car | | | | Moving from W to SE | Going ahead right bend | |
| Casualty Reference: 1 | | Age: 27 | Male | | Driver/rider | Severity: Slight | Injured by vehicle: 2 |

| | | | | | | | |
|-------------------------|------------|--------------------|---------|--------------|---|------------------------------|-----------------------|
| Tuesday | 28/03/2006 | Time 1620 | Slight | at | A4260 APPROX 70M S OF J/W B4030 AT HOPCROFTS HOLT | STEEPLE BARTON | 109 |
| E: 446524 | N: 224990 | Junction Detail: 0 | Control | | | | |
| Fine without high winds | | | | Road surface | Dry | Daylight: no street lighting | |
| Vehicle Reference 1 | Car | | | | Moving from S to N | Stopping | |
| Casualty Reference: 1 | | Age: 37 | Female | | Driver/rider | Severity: Slight | Injured by vehicle: 1 |
| Vehicle Reference 2 | Car | | | | Moving from S to N | Stopping | |
| Casualty Reference: 2 | | Age: 52 | Female | | Driver/rider | Severity: Slight | Injured by vehicle: 2 |
| Vehicle Reference 3 | Car | | | | Moving from S to N | Stopping | |
| Casualty Reference: 3 | | Age: 30 | Male | | Passenger | Severity: Slight | Injured by vehicle: 3 |
| Casualty Reference: 4 | | Age: 38 | Female | | Passenger | Severity: Slight | Injured by vehicle: 3 |

| | | | | | | | |
|-----------------------|-----------------------|--------------------|-----------|--------------|---|---------------------------------|-----------------------|
| Saturday | 08/04/2006 | Time 1600 | Serious | at | A43 AT RBT J/W CHERWELL VALLEY SERVICES & M40 SBOUND ENTRY SLIP | STOKE LYNE | 111 |
| E: 454816 | N: 228159 | Junction Detail: 1 | Control 4 | | | | |
| Fine with high winds | | | | Road surface | Dry | Daylight: street lights present | |
| Vehicle Reference 1 | Motorcycle over 500cc | | | | Moving from N to S | Going ahead other | |
| Casualty Reference: 1 | | Age: 44 | Female | | Driver/rider | Severity: Serious | Injured by vehicle: 1 |

Accidents between dates 01/08/2001 and 31/07/2006 (60) months

Selection: Notes:

Selected using Manual Selection

Friday 28/04/2006 Time 1337 Slight at A43 AT RBT J/W CHERWELL VALLEY SERVICES (NOTE: SOME UNCERTAINTY OVER APPROACH OF RBT ACC)

112

E: 454812 N: 228150 Junction Detail: 1 Control 4

Fine without high winds

Road surface Dry

Daylight:street lights present

Vehicle Reference 1 Motor Cycle over 125 cc and up to 500cc

Moving from N to S

Waiting to turn left

Casualty Reference: 1 Age: 32 Male

Driver/rider

Severity: Slight

Injured by vehicle: 1

Vehicle Reference 2 Car

Moving from N to S

Going ahead other

Friday 19/05/2006 Time 1825 Slight at B430 OXFORD RD AT J/W B4030 BICESTER RD CROSS ROADS MIDDLETON STONEY

113

E: 453432 N: 223477 Junction Detail: 6 Control 2

Other

Road surface Wet/Damp

Daylight: no street lighting

Vehicle Reference 1 Goods 3.5 tonnes mgw and under

Moving from S to E

Waiting to turn right

Casualty Reference: 4 Age: Male

Driver/rider

Severity: Slight

Injured by vehicle: 1

Vehicle Reference 2 Car

Moving from N to S

Going ahead other

Casualty Reference: 1 Age: Female

Driver/rider

Severity: Slight

Injured by vehicle: 2

Casualty Reference: 2 Age: Male

Passenger

Severity: Slight

Injured by vehicle: 2

Casualty Reference: 3 Age: Male

Passenger

Severity: Slight

Injured by vehicle: 2

Monday 22/05/2006 Time 0619 Slight at A43 RBT J/W M40 NBOUND EXIT SLIP & B430 STOKE LYNE

114

E: 454528 N: 227895 Junction Detail: 1 Control 4

Raining without high winds

Road surface Wet/Damp

Daylight:street lights present

Vehicle Reference 1 Goods 7.5 tonnes mgw and over

Moving from SE to NE

Turning right

Casualty Reference: 1 Age: 35 Male

Driver/rider

Severity: Slight

Injured by vehicle: 1

Accidents between dates **01/08/2001 and 31/07/2006** (60) months

Selection: **Notes:**

Selected using Manual Selection

Tuesday 23/05/2006 Time 1300 Slight at CAMP ROAD APPROX 600M M N OF J/W B4030 MIDDLETON STONEY
E: 452353 N: 224991 Junction Detail: 0 Control
Fine without high winds Road surface Dry Daylight: no street lighting
Vehicle Reference 1 Motor Cycle over 125 cc and up to 500cc Moving from N to SW Going ahead right bend
Casualty Reference: 1 Age: 22 Female Driver/rider Severity: Slight

115

Injured by vehicle: 1

Sunday 04/06/2006 Time 1435 Slight at B4030 BY HORSE & GROOM PH CAULCOTT LOWER HEYFORD
E: 450859 N: 224375 Junction Detail: 3 Control 4
Fine without high winds Road surface Dry Daylight:street lights present
Vehicle Reference 1 Car Moving from E to E U-turn
Vehicle Reference 2 Motorcycle over 500cc Moving from E to W Going ahead other
Casualty Reference: 1 Age: 23 Male Driver/rider Severity: Slight
Vehicle Reference 3 Car Moving from E to 0 Parked

116

Injured by vehicle: 2

Friday 09/06/2006 Time 1543 Slight at B430 STATION RD O/S UPLANDS APPROX 330M S OF J/W CHURCH RD ARDLEY
E: 454202 N: 227009 Junction Detail: 8 Control 4
Fine without high winds Road surface Dry Daylight: no street lighting
Vehicle Reference 1 Car Moving from SW to N Going ahead left bend
Casualty Reference: 1 Age: 24 Male Driver/rider Severity: Slight
Vehicle Reference 2 Car Moving from N to SW Going ahead right bend
Casualty Reference: 2 Age: 35 Female Driver/rider Severity: Slight

117

Injured by vehicle: 2

Friday 10/03/2006 Time 1540 Serious at B430 STATION RD APPROX 450M S OF J/W CHURCH RD ARDLEY
E: 454172 N: 226906 Junction Detail: 0 Control
Fine without high winds Road surface Dry Daylight: no street lighting
Vehicle Reference 1 Goods 3.5 tonnes mgw and under Moving from to 0 Going ahead other
Vehicle Reference 2 Motor Cycle over 125 cc and up to 500cc Moving from to 0 Going ahead other
Casualty Reference: 1 Age: 20 Male Driver/rider Severity: Serious

119

Injured by vehicle: 2

Accidents between dates 01/08/2001 and 31/07/2006 (60) months

Selection: Notes:

Selected using Manual Selection

121

Tuesday 04/07/2006 Time 0655 Slight at A4260 NBOUND CWAY AT DUNS TEW DUAL CWAY SECTION (SOME UNCERTAINTY OVER EXACT LOCATION)
E: 446404 N: 227171 Junction Detail: 0 Control
Fine without high winds Road surface Dry Daylight: no street lighting
Vehicle Reference 1 Goods 3.5 tonnes mgw and under Moving from S to N Going ahead other
Casualty Reference: 1 Age: 35 Male Driver/rider Severity: Slight Injured by vehicle: 1

122

Monday 03/07/2006 Time 1521 Fatal at B430 APPROX 115M S OF J/W A43 RBT J/W M40 NBOUND EXIT SLIP ROAD STOKE LYNE (CHECK LOCATI
E: 454456 N: 227803 Junction Detail: 0 Control
Fine without high winds Road surface Dry Daylight: no street lighting
Vehicle Reference 1 Goods 7.5 tonnes mgw and over Moving from E to SW Going ahead left bend
Casualty Reference: 1 Age: 39 Male Driver/rider Severity: Fatal Injured by vehicle: 1
Vehicle Reference 2 Goods 7.5 tonnes mgw and over Moving from SW to E Going ahead right bend
Casualty Reference: 2 Age: 43 Male Driver/rider Severity: Slight Injured by vehicle: 2

Saturday 08/07/2006 Time 1125 Slight at A43 RBT J/W B430 AND M40 NBOUND EXIT STOKE LYNE
E: 454567 N: 227926 Junction Detail: 1 Control 4
Fine without high winds Road surface Dry Daylight:street lights present
Vehicle Reference 1 Car Moving from S to NE Going ahead right bend
Casualty Reference: 1 Age: 17 Female Driver/rider Severity: Slight Injured by vehicle: 1
Vehicle Reference 2 Car Moving from S to NE Going ahead right bend

123

Accidents between dates 01/08/2001 and 31/07/2006 (60) months

Selection:

Notes:

Selected using Manual Selection

Sunday 23/07/2006 Time 1642 Slight at A43 AT RBT J/W ACCESS TO MOTO SERVICES AT J10 STOKE LYNE

E: 454781 N: 228153 Junction Detail: 1 Control 4

Fine without high winds Road surface Dry

Vehicle Reference 1 Goods 7.5 tonnes mgw and over

Vehicle Reference 2 Car

Casualty Reference: 1 Age: 27 Female

Daylight:street lights present

Moving from SW to NE

Moving from SW to N

Driver/rider

Going ahead other

Turning left

Severity: Slight

124

Injured by vehicle: 2

125

Tuesday 23/05/2006 Time 1300 Slight at CAMP ROAD BETWEEN UPPER HEYFORD AND MIDDLETON STONEY - NO OTHER LOCATION DETAILS SUP

E: 452290 N: 225260 Junction Detail: 0 Control

Fine without high winds Road surface Dry

Vehicle Reference 1 Motor Cycle over 125 cc and up to 500cc

Casualty Reference: 1 Age: Female

Daylight: no street lighting

Moving from to 0

Driver/rider

Going ahead other

Severity: Slight

Injured by vehicle: 1

Appendix H

**NRTF/TEMPRO Traffic
Growth Calculations**

DERIVATION OF GROWTH FACTORS

North Oxfordshire 2004 to 2006

TEMPRO Trip End Totals by Time Period by TEMPRO zone

| | AM | | | | PM | | |
|---------------------|--------|-------------|--------------|----------|--------|-------------|--------------|
| | Origin | Destination | Total | | Origin | Destination | Total |
| 2004 Cherwell Rural | 13516 | 11232 | 24748 | | 13139 | 14996 | 28135 |
| Bicester | 10730 | 8303 | 19033 | | 9812 | 11758 | 21570 |
| Total | | | 43781 | <i>a</i> | | | 49705 |
| 2006 Cherwell Rural | 14021 | 11567 | 25588 | | 13536 | 15523 | 29059 |
| Bicester | 11123 | 8558 | 19681 | | 10117 | 12169 | 22286 |
| Total | | | 45269 | <i>b</i> | | | 51345 |

TEMPRO Trip End Totals for Average Day for GB

| | Origin | Destination | Total | |
|---------|----------|-------------|------------------|----------|
| 2004 GB | 69034029 | 69034029 | 138068058 | <i>d</i> |
| 2006 GB | 70502673 | 70502673 | 141005346 | <i>e</i> |

Growth Factors from 2005 by Time Period

| | AM | PM | |
|------|--------|--------|------------|
| 2006 | 1.0340 | 1.0330 | <i>b/a</i> |

Growth Factors from 2005 for Average Day

| | | |
|------|--------|------------|
| 2006 | 1.0213 | <i>e/d</i> |
|------|--------|------------|

NRTF 97 Factor for Total Traffic from 2005(%)

| | | | |
|------|---------|--------|----------|
| 2006 | Central | 1.0341 | <i>g</i> |
|------|---------|--------|----------|

Locally Adjusted NRTF factors for AM and PM peak periods

| | | | |
|------|--------------|--------------|-----------------|
| | | Central | |
| | AM | PM | |
| 2006 | 1.047 | 1.046 | $g*(b/a)/(e/d)$ |

Note:

These calculations are based on paragraphs 5.6 to 5.7 of the TEMPRO Guidance Note

These calculations assume that the roads to which these factors are applied primarily serve the Cherwell Rural and Bicester areas.

DERIVATION OF GROWTH FACTORS

North Oxfordshire 2006 to 2013

TEMPRO Trip End Totals by Time Period by TEMPRO zone

| | AM | | | | PM | | |
|---------------------|--------|-------------|--------------|----------|--------|-------------|--------------|
| | Origin | Destination | Total | | Origin | Destination | Total |
| 2006 Cherwell Rural | 14021 | 11567 | 25588 | | 13536 | 15523 | 29059 |
| Bicester | 11123 | 8558 | 19681 | | 10117 | 12169 | 22286 |
| Total | | | 45269 | <i>a</i> | | | 51345 |
| 2013 Cherwell Rural | 15302 | 12423 | 27725 | | 14581 | 16905 | 31486 |
| Bicester | 12223 | 9220 | 21443 | | 10947 | 13348 | 24295 |
| Total | | | 49168 | <i>b</i> | | | 55781 |

TEMPRO Trip End Totals for Average Day for GB

| | Origin | Destination | Total | |
|---------|----------|-------------|------------------|----------|
| 2006 GB | 70502673 | 70502673 | 141005346 | <i>d</i> |
| 2013 GB | 75458691 | 75458691 | 150917382 | <i>e</i> |

Growth Factors from 2006 by Time Period

| | AM | PM | |
|------|--------|--------|------------|
| 2013 | 1.0861 | 1.0864 | <i>b/a</i> |

Growth Factors from 2006 for Average Day

| | | |
|------|--------|------------|
| 2013 | 1.0703 | <i>e/d</i> |
|------|--------|------------|

NRTF 97 Factor for Total Traffic from 2006(%)

| | | | |
|------|---------|-------|----------|
| 2013 | Central | 1.111 | <i>g</i> |
|------|---------|-------|----------|

Locally Adjusted NRTF factors for AM and PM peak periods

| | | | |
|------|--------------|--------------|----------------------|
| | | Central | |
| | AM | PM | |
| 2013 | 1.127 | 1.128 | <i>g*(b/a)/(e/d)</i> |

Note:

These calculations are based on paragraphs 5.6 to 5.7 of the TEMPRO Guidance Note
 These calculations assume that the roads to which these factors are applied primarily serve the Cherwell Rural and Bicester areas.

DERIVATION OF GROWTH FACTORS

North Oxfordshire 2006 to 2028

TEMPRO Trip End Totals by Time Period by TEMPRO zone

| | AM | | | | PM | | |
|---------------------|--------|-------------|--------------|----------|--------|-------------|--------------|
| | Origin | Destination | Total | | Origin | Destination | Total |
| 2006 Cherwell Rural | 14021 | 11567 | 25588 | | 13536 | 15523 | 29059 |
| Bicester | 11123 | 8558 | 19681 | | 10117 | 12169 | 22286 |
| Total | | | 45269 | <i>a</i> | | | 51345 |
| 2028 Cherwell Rural | 16813 | 13335 | 30148 | | 15838 | 18660 | 34498 |
| Bicester | 13450 | 9928 | 23378 | | 11926 | 14751 | 26677 |
| Total | | | 53526 | <i>b</i> | | | 61175 |

TEMPRO Trip End Totals for Average Day for GB

| | Origin | Destination | Total | |
|---------|----------|-------------|------------------|----------|
| 2006 GB | 70502673 | 70502673 | 141005346 | <i>d</i> |
| 2028 GB | 75458691 | 75458691 | 150917382 | <i>e</i> |

Growth Factors from 2006 by Time Period

| | AM | PM | |
|------|--------|--------|------------|
| 2028 | 1.1824 | 1.1914 | <i>b/a</i> |

Growth Factors from 2006 for Average Day

| | | |
|------|--------|------------|
| 2028 | 1.0703 | <i>e/d</i> |
|------|--------|------------|

NRTF 97 Factor for Total Traffic from 2006(%)

| | | | |
|------|---------|-------|----------|
| 2028 | Central | 1.111 | <i>g</i> |
|------|---------|-------|----------|

Locally Adjusted NRTF factors for AM and PM peak periods

| | | | |
|------|--------------|--------------|----------------------|
| | | Central | |
| | AM | PM | |
| 2028 | 1.227 | 1.237 | <i>g*(b/a)/(e/d)</i> |

Note:

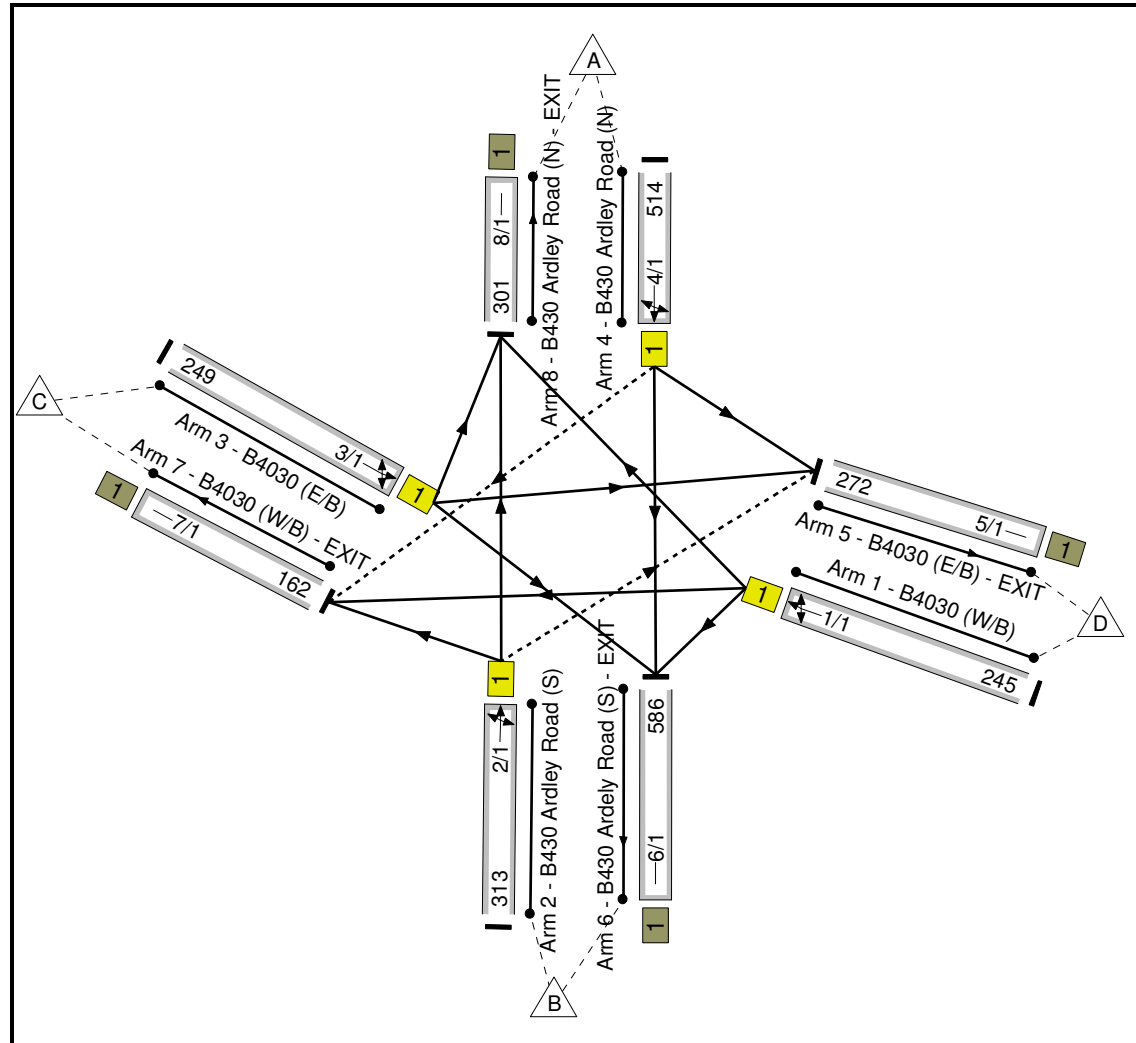
These calculations are based on paragraphs 5.6 to 5.7 of the TEMPRO Guidance Note
 These calculations assume that the roads to which these factors are applied primarily serve the Cherwell Rural and Bicester areas.

Appendix I

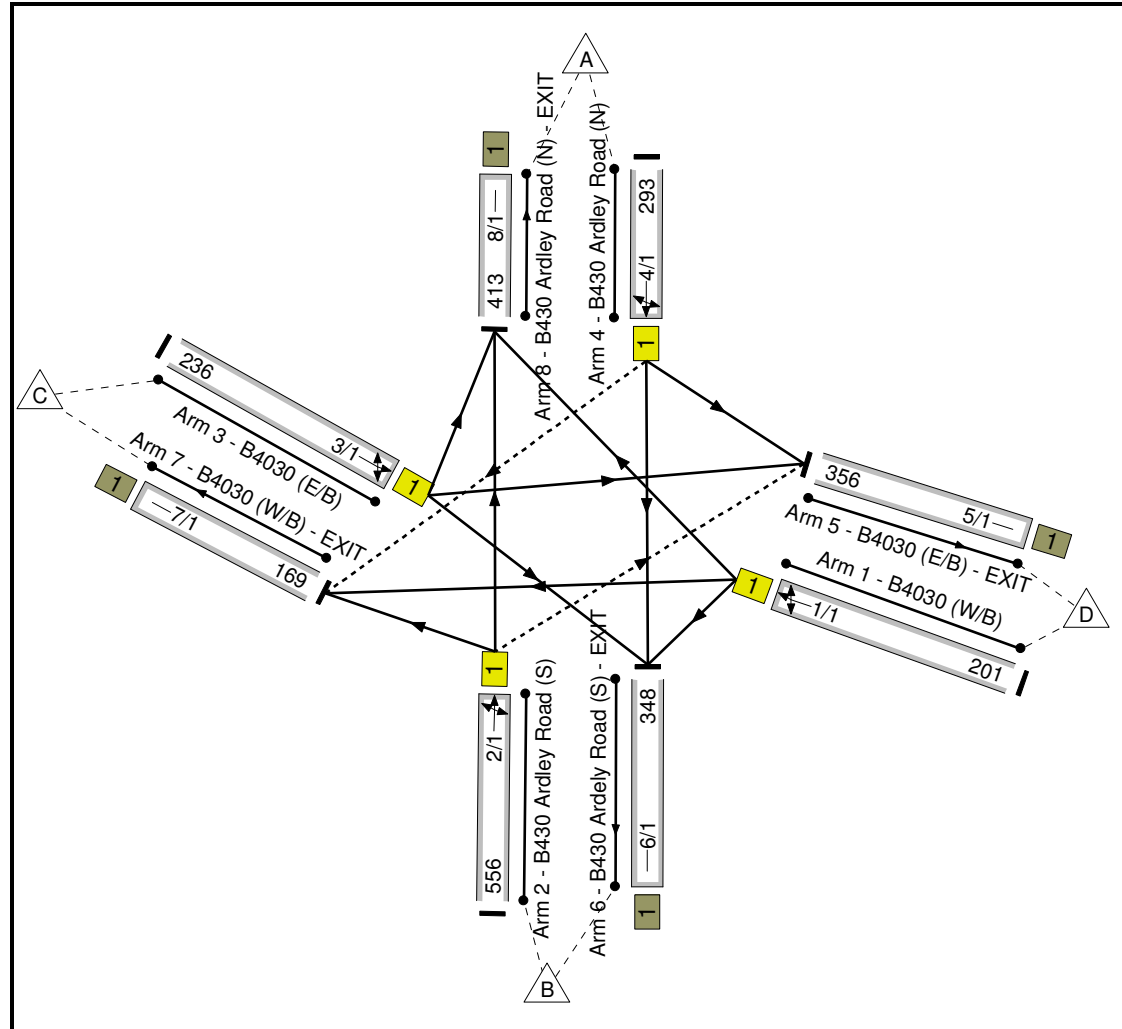
**B4030/B430 Junction at
Middleton Stoney:
LINSIG Analyses**

Middleton Stoney Jct 2006 Base

Junction Layout Diagram Flow Group 1: '2006 Base AM'



Flow Group 2: '2006 Base PM'



Lane Data Table

| Arm/ Lane | Actual Length (PCU) | Effective Length (PCU) | Sat Flow Type | User Saturation Flow (PCU/Hr) | Lane Width (m) | Gradient | Nearside Lane | Allowed Turns | Turning Radius (m) |
|--------------------------------------|---------------------------|------------------------------|------------------|--|----------------------|----------|------------------|--|--------------------------|
| 1/1 (B4030 (W/B) Lane 1) | Inf | Inf | Geom | 1800 | 3.20 | 0.00 | Y | Arm 6 Left (B430 Ardely Road (S) - EXIT) | 17.50 |
| | | | | | | | | Arm 7 Ahead (B4030 (W/B) - EXIT) | 45.00 |
| | | | | | | | | Arm 8 Right (B430 Ardley Road (N) - EXIT) | 12.50 |
| 2/1 (B430 Ardley Road (S) Lane 1) | Inf | Inf | Geom | 1800 | 3.50 | 0.00 | Y | Arm 5 Right (B4030 (E/B) - EXIT) | 10.00 |
| | | | | | | | | Arm 7 Left (B4030 (W/B) - EXIT) | 27.50 |
| | | | | | | | | Arm 8 Ahead (B430 Ardley Road (N) - EXIT) | Inf |
| 3/1 (B4030 (E/B) Lane 1) | Inf | Inf | Geom | 1800 | 3.50 | 0.00 | Y | Arm 5 Ahead (B4030 (E/B) - EXIT) | Inf |
| | | | | | | | | Arm 6 Right (B430 Ardely Road (S) - EXIT) | 45.00 |
| | | | | | | | | Arm 8 Left (B430 Ardley Road (N) - EXIT) | 7.50 |
| 4/1 (B430 Ardley Road (N) Lane 1) | Inf | Inf | Geom | 1800 | 3.75 | 0.00 | Y | Arm 5 Left (B4030 (E/B) - EXIT) | 17.50 |
| | | | | | | | | Arm 6 Ahead (B430 Ardely Road (S) - EXIT) | Inf |
| | | | | | | | | Arm 7 Right (B4030 (W/B) - EXIT) | 7.50 |
| 5/1 (B4030 (E/B) - EXIT Lane 1) | Inf | Inf | User | 9999 | 3.25 | 0.00 | N | | |

| | | | | | | | | | |
|---|-----|-----|------|------|------|------|---|--|--|
| 6/1 (B430 Ardely Road (S) - EXIT Lane 1) | Inf | Inf | User | 9999 | 3.25 | 0.00 | N | | |
| 7/1 (B4030 (W/B) - EXIT Lane 1) | Inf | Inf | User | 9999 | 3.25 | 0.00 | N | | |
| 8/1 (B430 Ardley Road (N) - EXIT Lane 1) | Inf | Inf | User | 9999 | 3.25 | 0.00 | N | | |

Lane Data Table**Flow Group 1: '2006 Base AM'**

| Arm/ Lane | Lane Width (m) | Gradient | Nearside Lane | Allowed Turns | Turning Radius (m) | Turning Prop. | Sat flow (PCU/Hr) |
|--------------------------------------|---|----------|------------------|--|--------------------------|------------------|----------------------|
| 1/1 (B4030 (W/B) Lane 1) | 3.20 | 0.00 | Y | Arm 6 Left (B430 Ardely Road (S) - EXIT) | 17.50 | 25.7 % | 1804 |
| | | | | Arm 7 Ahead (B4030 (W/B) - EXIT) | 45.00 | 44.5 % | |
| | | | | Arm 8 Right (B430 Ardely Road (N) - EXIT) | 12.50 | 29.8 % | |
| 2/1 (B430 Ardley Road (S) Lane 1) | 3.50 | 0.00 | Y | Arm 5 Right (B4030 (E/B) - EXIT) | 10.00 | 16.6 % | 1904 |
| | | | | Arm 7 Left (B4030 (W/B) - EXIT) | 27.50 | 12.8 % | |
| | | | | Arm 8 Ahead (B430 Ardley Road (N) - EXIT) | Inf | 70.6 % | |
| 3/1 (B4030 (E/B) Lane 1) | 3.50 | 0.00 | Y | Arm 5 Ahead (B4030 (E/B) - EXIT) | Inf | 73.9 % | 1939 |
| | | | | Arm 6 Right (B430 Ardely Road (S) - EXIT) | 45.00 | 23.3 % | |
| 4/1 (B430 Ardley Road (N) Lane 1) | 3.75 | 0.00 | Y | Arm 8 Left (B430 Ardley Road (N) - EXIT) | 7.50 | 2.8 % | 1968 |
| | | | | Arm 5 Left (B4030 (E/B) - EXIT) | 17.50 | 7.0 % | |
| | | | | Arm 6 Ahead (B430 Ardely Road (S) - EXIT) | Inf | 90.5 % | |
| 5/1 (B4030 (E/B) - EXIT Lane 1) | This lane uses a directly entered Saturation Flow | | | | | | 9999 |

| | | |
|---|--|-------------|
| <p>6/1 (B430 Ardely Road (S) - EXIT Lane 1)</p> | <p>This lane uses a directly entered Saturation Flow</p> | <p>9999</p> |
| <p>7/1 (B4030 (W/B) - EXIT Lane 1)</p> | <p>This lane uses a directly entered Saturation Flow</p> | <p>9999</p> |
| <p>8/1 (B430 Ardley Road (N) - EXIT Lane 1)</p> | <p>This lane uses a directly entered Saturation Flow</p> | <p>9999</p> |

Flow Group 2: '2006 Base PM'

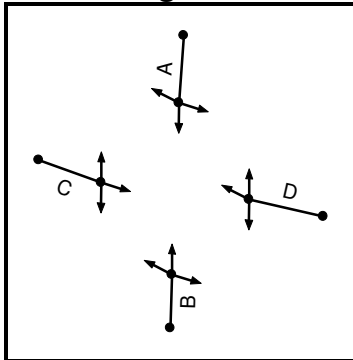
| Arm/ Lane | Lane Width (m) | Gradient | Nearside Lane | Allowed Turns | Turning Radius (m) | Turning Prop. | Sat flow (PCU/Hr) |
|--------------------------------------|---|----------|------------------|--|--------------------------|------------------|----------------------|
| 1/1 (B4030 (W/B) Lane 1) | 3.20 | 0.00 | Y | Arm 6 Left (B430 Ardely Road (S) - EXIT) | 17.50 | 24.4 % | 1831 |
| | | | | Arm 7 Ahead (B4030 (W/B) - EXIT) | 45.00 | 63.2 % | |
| | | | | Arm 8 Right (B430 Ardley Road (N) - EXIT) | 12.50 | 12.4 % | |
| 2/1 (B430 Ardley Road (S) Lane 1) | 3.50 | 0.00 | Y | Arm 5 Right (B4030 (E/B) - EXIT) | 10.00 | 27.9 % | 1880 |
| | | | | Arm 7 Left (B4030 (W/B) - EXIT) | 27.50 | 5.9 % | |
| | | | | Arm 8 Ahead (B430 Ardley Road (N) - EXIT) | Inf | 66.2 % | |
| 3/1 (B4030 (E/B) Lane 1) | 3.50 | 0.00 | Y | Arm 5 Ahead (B4030 (E/B) - EXIT) | Inf | 69.9 % | 1919 |
| | | | | Arm 6 Right (B430 Ardely Road (S) - EXIT) | 45.00 | 21.6 % | |
| | | | | Arm 8 Left (B430 Ardley Road (N) - EXIT) | 7.50 | 8.5 % | |
| 4/1 (B430 Ardley Road (N) Lane 1) | 3.75 | 0.00 | Y | Arm 5 Left (B4030 (E/B) - EXIT) | 17.50 | 12.3 % | 1957 |
| | | | | Arm 6 Ahead (B430 Ardely Road (S) - EXIT) | Inf | 84.6 % | |
| | | | | Arm 7 Right (B4030 (W/B) - EXIT) | 7.50 | 3.1 % | |
| 5/1 (B4030 (E/B) - EXIT Lane 1) | This lane uses a directly entered Saturation Flow | | | | | | 9999 |

| | | |
|---|--|-------------|
| <p>6/1 (B430 Ardely Road (S) - EXIT Lane 1)</p> | <p>This lane uses a directly entered Saturation Flow</p> | <p>9999</p> |
| <p>7/1 (B4030 (W/B) - EXIT Lane 1)</p> | <p>This lane uses a directly entered Saturation Flow</p> | <p>9999</p> |
| <p>8/1 (B430 Ardley Road (N) - EXIT Lane 1)</p> | <p>This lane uses a directly entered Saturation Flow</p> | <p>9999</p> |

Intergreens Table

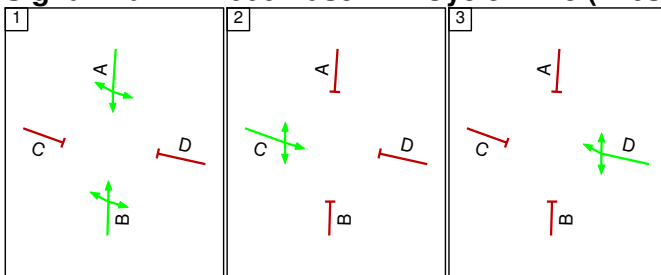
| | Starting Phase | | | |
|----------------------|----------------|---|---|---|
| | A | B | C | D |
| Terminating Phase | A | - | 7 | 7 |
| | B | - | 7 | 7 |
| | C | 7 | 7 | - |
| | D | 7 | 7 | 7 |
| | | | | |

Phase Diagram

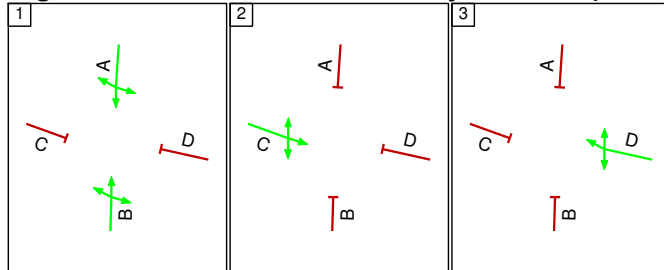


Stages Diagram

Signal Plan 1: '2006 Base AM' Cycle Time (120s)



Signal Plan 2: '2006 Base PM' Cycle Time (120s)



Signal Plans Data table

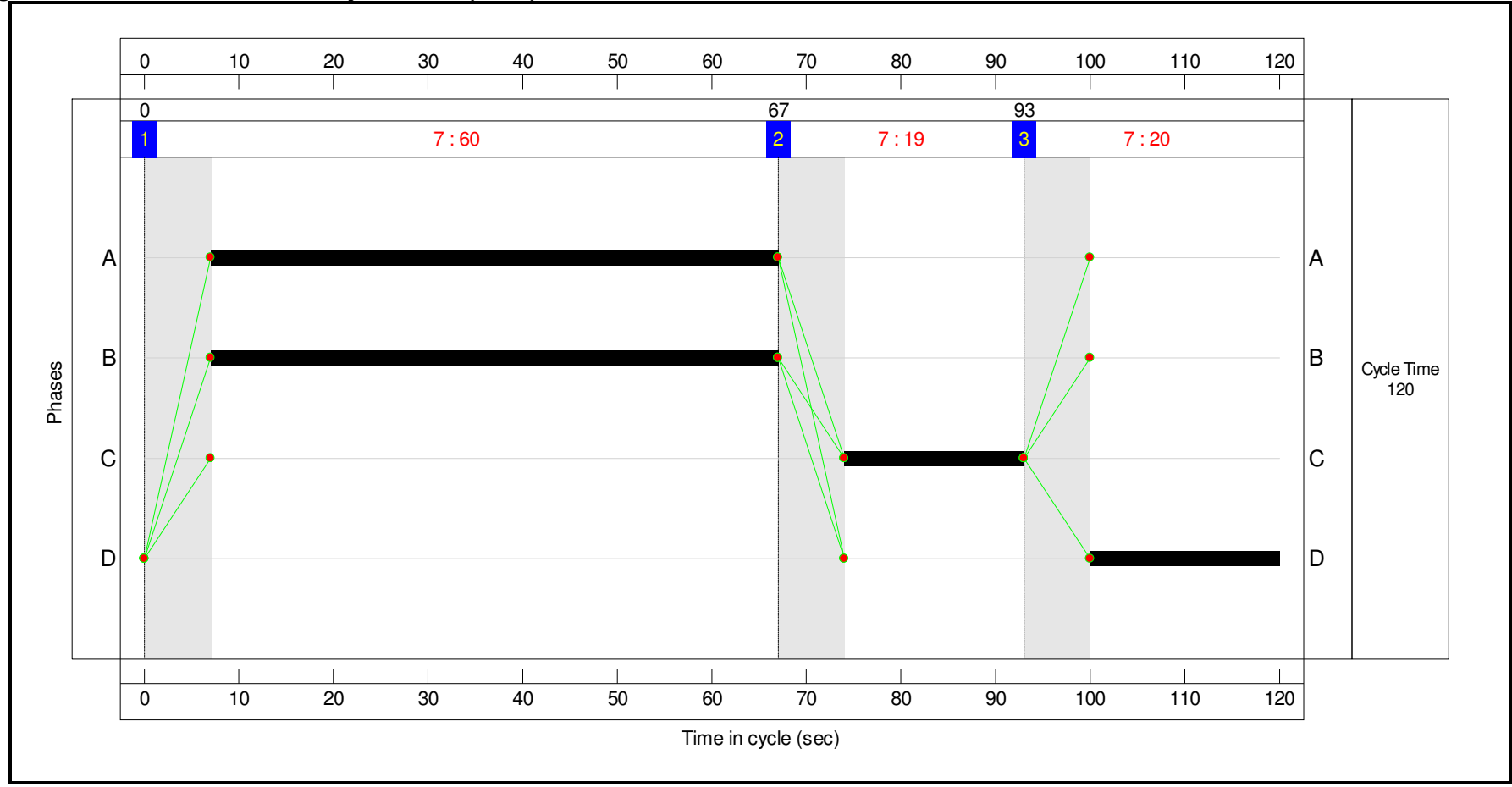
Signal Plan 1: '2006 Base AM' Cycle Time (120s)

| Stage | 1 | 2 | 3 |
|--------------|----|----|----|
| Duration | 60 | 19 | 20 |
| Change Point | 0 | 67 | 93 |

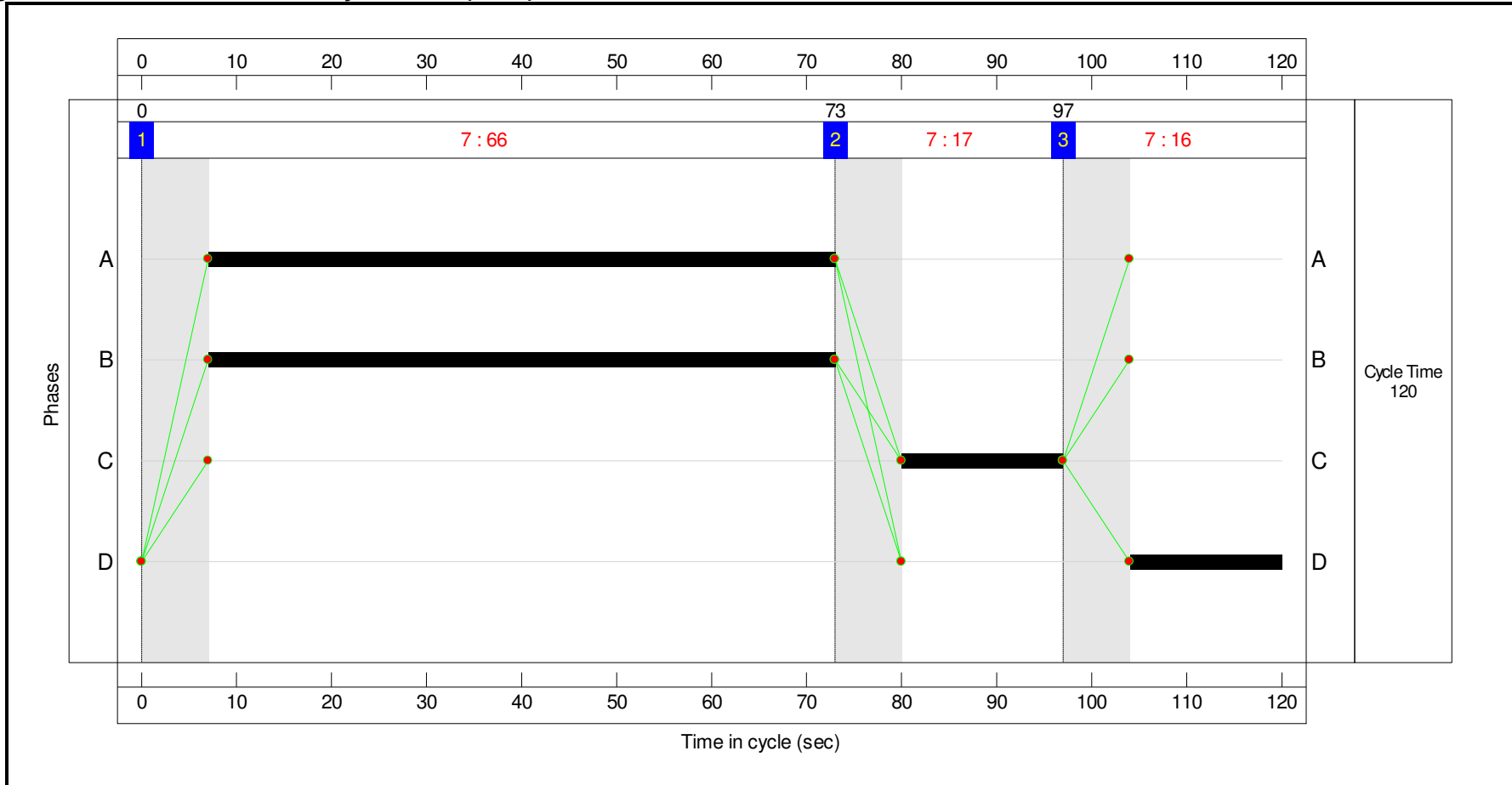
Signal Plan 2: '2006 Base PM' Cycle Time (120s)

| Stage | 1 | 2 | 3 |
|--------------|----|----|----|
| Duration | 66 | 17 | 16 |
| Change Point | 0 | 73 | 97 |

Signal Timings Diagram Signal Plan 1: '2006 Base AM' Cycle Time (120s)



Signal Plan 2: '2006 Base PM' Cycle Time (120s)



Traffic Flow Matrix

Flow Group 1: '2006 Base AM'

Desired Flow :

| | | Destination | | | | | Tot. |
|--------|------|-------------|-----|-----|-----|------|------|
| | | A | B | C | D | | |
| Origin | A | 0 | 465 | 13 | 36 | 514 | |
| | B | 221 | 0 | 40 | 52 | 313 | |
| | C | 7 | 58 | 0 | 184 | 249 | |
| | D | 73 | 63 | 109 | 0 | 245 | |
| | Tot. | 301 | 586 | 162 | 272 | 1321 | |

Flow Group 2: '2006 Base PM'

Desired Flow :

| | | Destination | | | | | Tot. |
|--------|------|-------------|-----|-----|-----|------|------|
| | | A | B | C | D | | |
| Origin | A | 0 | 248 | 9 | 36 | 293 | |
| | B | 368 | 0 | 33 | 155 | 556 | |
| | C | 20 | 51 | 0 | 165 | 236 | |
| | D | 25 | 49 | 127 | 0 | 201 | |
| | Tot. | 413 | 348 | 169 | 356 | 1286 | |

Traffic Flow Groups Data

| Flow Group | Start Time | End Time | Duration | Formula |
|-------------------|------------|----------|----------|---------|
| 1: '2006 Base AM' | 08:00 | 09:00 | 01:00 | |
| 2: '2006 Base PM' | 17:00 | 18:00 | 01:00 | |

Link Results**Scenario 1: '2006 Base AM'**

Signal Plan 1: '2006 Base AM' Cycle Time (120s)

Flow Group 1: '2006 Base AM'

| Link Num | Link Desc | Link Type | Deg Sat (%) | Mean Max Queue (pcu) | Full Phase | Arrow Phase | Total Green (s) | Demand Flow (pcu) | Max Sat Flow (pcu/Hr) | Ave Sat Flow (pcu/Hr) | Capacity (pcu) | |
|------------------------------|---------------------------------------|-----------|-------------|--|------------|-------------|-----------------|---------------------|-----------------------|-----------------------|----------------|--|
| 1/1 | B4030 (W/B) Left Ahead Right | U | 77.6 | 9.4 | D | | 20 | 245 | 1804 | 1804 | 316 | |
| 2/1 | B430 Ardley Road (S) Right Left Ahead | O | 69.1 | 7.4 | B | | 60 | 313 | 1904 | 891 | 453 | |
| 3/1 | B4030 (E/B) Ahead Right Left | U | 77.1 | 9.5 | C | | 19 | 249 | 1939 | 1939 | 323 | |
| 4/1 | B430 Ardley Road (N) Left Ahead Right | O | 80.6 | 16.4 | A | | 60 | 514 | 1968 | 1255 | 638 | |
| PRC for Signalled Links (%): | | | 11.7 | Total Delay for Signalled Links (pcuHr): | | | 18.83 | | | | | |
| PRC Over All Links (%): | | | 11.7 | Total Delay Over All Links(pcuHr): | | | 18.90 | Cycle Time (s): 120 | | | | |

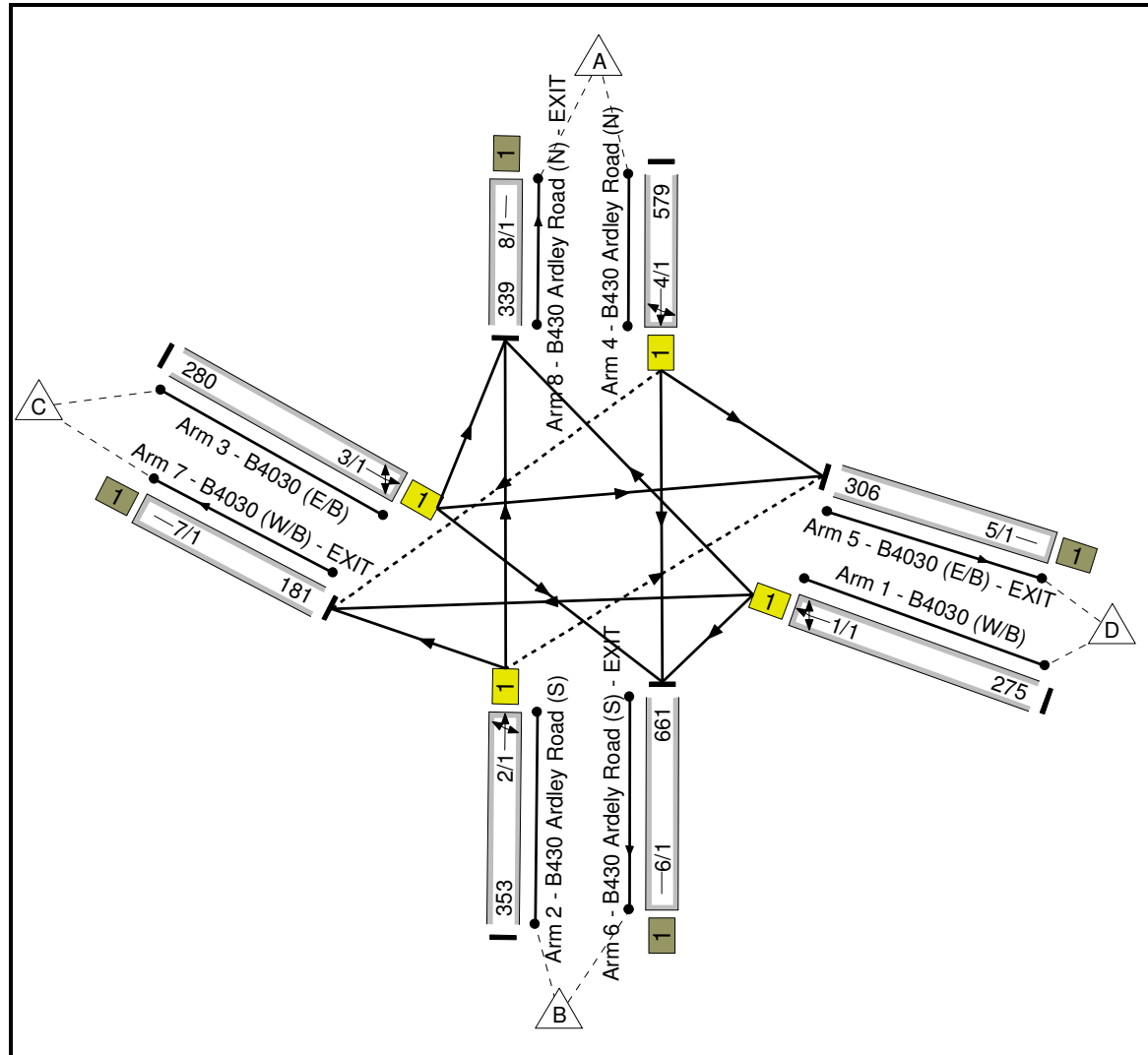
Scenario 2: '2006 Base PM'

Signal Plan 2: '2006 Base PM' Cycle Time (120s)

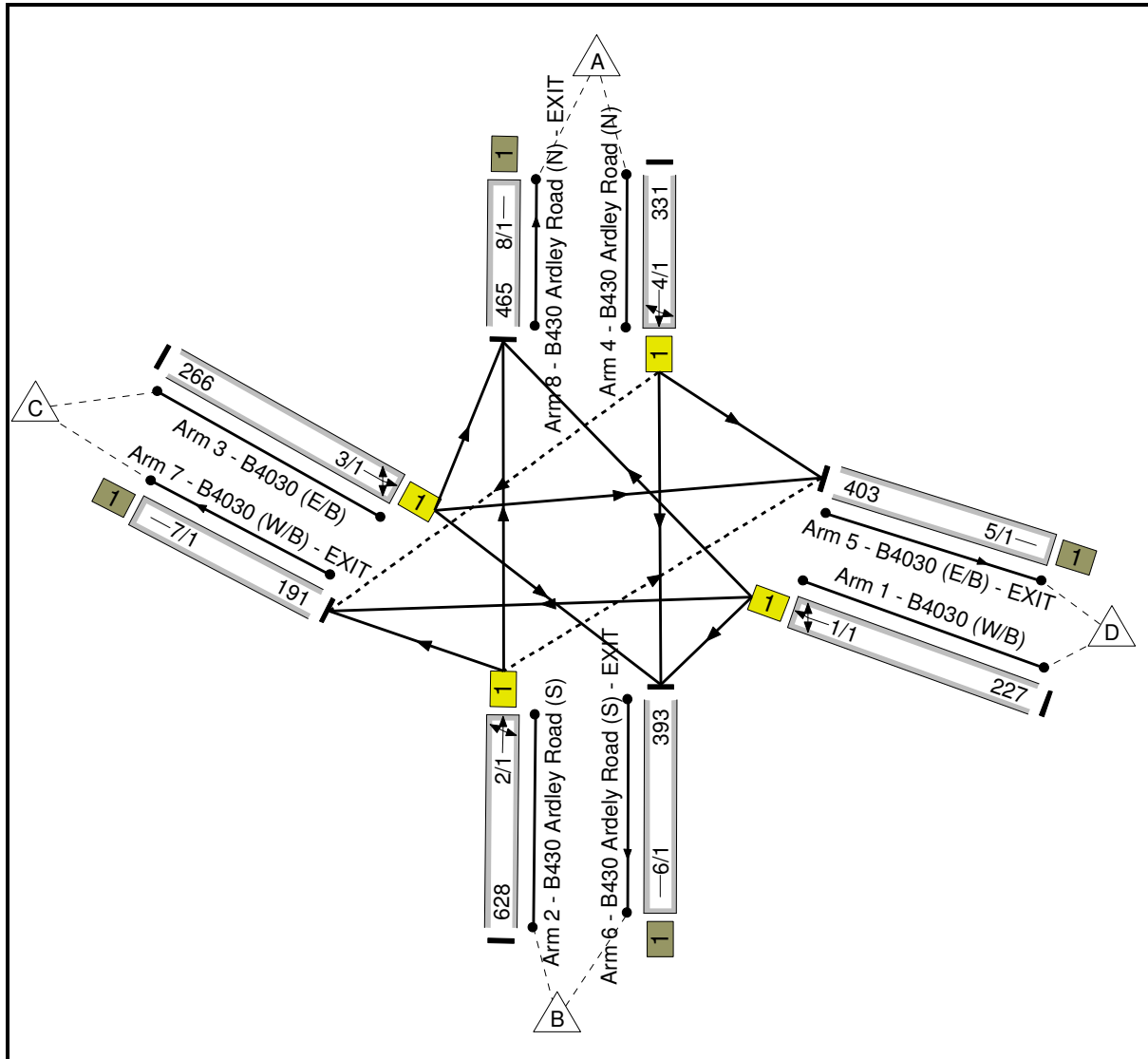
Flow Group 2: '2006 Base PM'

| Link Num | Link Desc | Link Type | Deg Sat (%) | Mean Max Queue (pcu) | Full Phase | Arrow Phase | Total Green (s) | Demand Flow (pcu) | Max Sat Flow (pcu/Hr) | Ave Sat Flow (pcu/Hr) | Capacity (pcu) | |
|------------------------------|---------------------------------------|-----------|-------------|--|------------|-------------|-----------------|---------------------|-----------------------|-----------------------|----------------|--|
| 1/1 | B4030 (W/B) Left Ahead Right | U | 77.5 | 8.1 | D | | 16 | 201 | 1831 | 1831 | 259 | |
| 2/1 | B430 Ardley Road (S) Right Left Ahead | O | 81.1 | 14.3 | B | | 66 | 556 | 1880 | 1227 | 685 | |
| 3/1 | B4030 (E/B) Ahead Right Left | U | 82.0 | 9.7 | C | | 17 | 236 | 1919 | 1919 | 288 | |
| 4/1 | B430 Ardley Road (N) Left Ahead Right | O | 61.2 | 8.7 | A | | 66 | 293 | 1957 | 858 | 479 | |
| PRC for Signalled Links (%): | | | 9.8 | Total Delay for Signalled Links (pcuHr): | | | 17.77 | | | | | |
| PRC Over All Links (%): | | | 9.8 | Total Delay Over All Links(pcuHr): | | | 17.84 | Cycle Time (s): 120 | | | | |

Middleton Stoney Jct 2013 Base
Junction Layout Diagram
Flow Group 1: '2013 Base AM'



Flow Group 2: '2013 Base PM'



Lane Data Table

| Arm/ Lane | Actual Length (PCU) | Effective Length (PCU) | Sat Flow Type | User Saturation Flow (PCU/Hr) | Lane Width (m) | Gradient | Nearside Lane | Allowed Turns | Turning Radius (m) |
|--------------------------------------|---------------------------|------------------------------|------------------|--|----------------------|----------|------------------|--|--------------------------|
| 1/1 (B4030 (W/B) Lane 1) | Inf | Inf | Geom | 1800 | 3.20 | 0.00 | Y | Arm 6 Left (B430 Ardely Road (S) - EXIT) | 17.50 |
| | | | | | | | | Arm 7 Ahead (B4030 (W/B) - EXIT) | 45.00 |
| | | | | | | | | Arm 8 Right (B430 Ardley Road (N) - EXIT) | 12.50 |
| 2/1 (B430 Ardley Road (S) Lane 1) | Inf | Inf | Geom | 1800 | 3.50 | 0.00 | Y | Arm 5 Right (B4030 (E/B) - EXIT) | 10.00 |
| | | | | | | | | Arm 7 Left (B4030 (W/B) - EXIT) | 27.50 |
| | | | | | | | | Arm 8 Ahead (B430 Ardley Road (N) - EXIT) | Inf |
| 3/1 (B4030 (E/B) Lane 1) | Inf | Inf | Geom | 1800 | 3.50 | 0.00 | Y | Arm 5 Ahead (B4030 (E/B) - EXIT) | Inf |
| | | | | | | | | Arm 6 Right (B430 Ardely Road (S) - EXIT) | 45.00 |
| | | | | | | | | Arm 8 Left (B430 Ardley Road (N) - EXIT) | 7.50 |
| 4/1 (B430 Ardley Road (N) Lane 1) | Inf | Inf | Geom | 1800 | 3.75 | 0.00 | Y | Arm 5 Left (B4030 (E/B) - EXIT) | 17.50 |
| | | | | | | | | Arm 6 Ahead (B430 Ardely Road (S) - EXIT) | Inf |
| | | | | | | | | Arm 7 Right (B4030 (W/B) - EXIT) | 7.50 |
| 5/1 (B4030 (E/B) - EXIT Lane 1) | Inf | Inf | User | 9999 | 3.25 | 0.00 | N | | |

| | | | | | | | | | |
|---|-----|-----|------|------|------|------|---|--|--|
| 6/1 (B430 Ardely Road (S) - EXIT Lane 1) | Inf | Inf | User | 9999 | 3.25 | 0.00 | N | | |
| 7/1 (B4030 (W/B) - EXIT Lane 1) | Inf | Inf | User | 9999 | 3.25 | 0.00 | N | | |
| 8/1 (B430 Ardley Road (N) - EXIT Lane 1) | Inf | Inf | User | 9999 | 3.25 | 0.00 | N | | |

Lane Data Table**Flow Group 1: '2013 Base AM'**

| Arm/ Lane | Lane Width (m) | Gradient | Nearside Lane | Allowed Turns | Turning Radius (m) | Turning Prop. | Sat flow (PCU/Hr) |
|--------------------------------------|----------------------|----------|------------------|---|--------------------------|------------------|----------------------|
| 1/1 (B4030 (W/B) Lane 1) | 3.20 | 0.00 | Y | Arm 6 Left (B430 Ardely Road (S) - EXIT) | 17.50 | 25.8 % | 1804 |
| | | | | Arm 7 Ahead (B4030 (W/B) - EXIT) | 45.00 | 44.4 % | |
| | | | | Arm 8 Right (B430 Ardley Road (N) - EXIT) | 12.50 | 29.8 % | |
| 2/1 (B430 Ardley Road (S) Lane 1) | 3.50 | 0.00 | Y | Arm 5 Right (B4030 (E/B) - EXIT) | 10.00 | 16.7 % | 1904 |
| | | | | Arm 7 Left (B4030 (W/B) - EXIT) | 27.50 | 12.7 % | |
| | | | | Arm 8 Ahead (B430 Ardley Road (N) - EXIT) | Inf | 70.5 % | |
| 3/1 (B4030 (E/B) Lane 1) | 3.50 | 0.00 | Y | Arm 5 Ahead (B4030 (E/B) - EXIT) | Inf | 73.9 % | 1939 |
| | | | | Arm 6 Right (B430 Ardely Road (S) - EXIT) | 45.00 | 23.2 % | |
| 4/1 (B430 Ardley Road (N) Lane 1) | 3.75 | 0.00 | Y | Arm 8 Left (B430 Ardley Road (N) - EXIT) | 7.50 | 2.9 % | 1969 |
| | | | | Arm 5 Left (B4030 (E/B) - EXIT) | 17.50 | 6.9 % | |
| | | | | Arm 6 Ahead (B430 Ardely Road (S) - EXIT) | Inf | 90.7 % | |
| 5/1 (B4030 (E/B) - EXIT Lane 1) | | | | Arm 7 Right (B4030 (W/B) - EXIT) | 7.50 | 2.4 % | 9999 |
| | | | | This lane uses a directly entered Saturation Flow | | | |

| | | |
|---|--|-------------|
| <p>6/1 (B430 Ardely Road (S) - EXIT Lane 1)</p> | <p>This lane uses a directly entered Saturation Flow</p> | <p>9999</p> |
| <p>7/1 (B4030 (W/B) - EXIT Lane 1)</p> | <p>This lane uses a directly entered Saturation Flow</p> | <p>9999</p> |
| <p>8/1 (B430 Ardley Road (N) - EXIT Lane 1)</p> | <p>This lane uses a directly entered Saturation Flow</p> | <p>9999</p> |

Flow Group 2: '2013 Base PM'

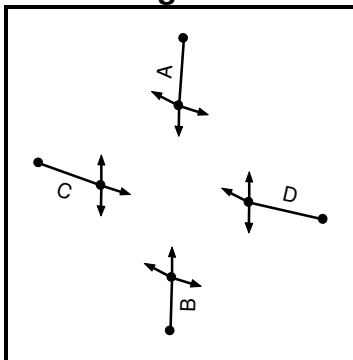
| Arm/ Lane | Lane Width (m) | Gradient | Nearside Lane | Allowed Turns | Turning Radius (m) | Turning Prop. | Sat flow (PCU/Hr) |
|--------------------------------------|---|----------|------------------|--|--------------------------|------------------|----------------------|
| 1/1 (B4030 (W/B) Lane 1) | 3.20 | 0.00 | Y | Arm 6 Left (B430 Ardely Road (S) - EXIT) | 17.50 | 24.7 % | 1831 |
| | | | | Arm 7 Ahead (B4030 (W/B) - EXIT) | 45.00 | 63.0 % | |
| | | | | Arm 8 Right (B430 Ardley Road (N) - EXIT) | 12.50 | 12.3 % | |
| 2/1 (B430 Ardley Road (S) Lane 1) | 3.50 | 0.00 | Y | Arm 5 Right (B4030 (E/B) - EXIT) | 10.00 | 27.9 % | 1880 |
| | | | | Arm 7 Left (B4030 (W/B) - EXIT) | 27.50 | 6.1 % | |
| | | | | Arm 8 Ahead (B430 Ardley Road (N) - EXIT) | Inf | 66.1 % | |
| 3/1 (B4030 (E/B) Lane 1) | 3.50 | 0.00 | Y | Arm 5 Ahead (B4030 (E/B) - EXIT) | Inf | 70.3 % | 1920 |
| | | | | Arm 6 Right (B430 Ardely Road (S) - EXIT) | 45.00 | 21.4 % | |
| | | | | Arm 8 Left (B430 Ardley Road (N) - EXIT) | 7.50 | 8.3 % | |
| 4/1 (B430 Ardley Road (N) Lane 1) | 3.75 | 0.00 | Y | Arm 5 Left (B4030 (E/B) - EXIT) | 17.50 | 12.4 % | 1957 |
| | | | | Arm 6 Ahead (B430 Ardely Road (S) - EXIT) | Inf | 84.6 % | |
| | | | | Arm 7 Right (B4030 (W/B) - EXIT) | 7.50 | 3.0 % | |
| 5/1 (B4030 (E/B) - EXIT Lane 1) | This lane uses a directly entered Saturation Flow | | | | | | 9999 |

| | | |
|---|--|-------------|
| <p>6/1 (B430 Ardely Road (S) - EXIT Lane 1)</p> | <p>This lane uses a directly entered Saturation Flow</p> | <p>9999</p> |
| <p>7/1 (B4030 (W/B) - EXIT Lane 1)</p> | <p>This lane uses a directly entered Saturation Flow</p> | <p>9999</p> |
| <p>8/1 (B430 Ardley Road (N) - EXIT Lane 1)</p> | <p>This lane uses a directly entered Saturation Flow</p> | <p>9999</p> |

Intergreens Table

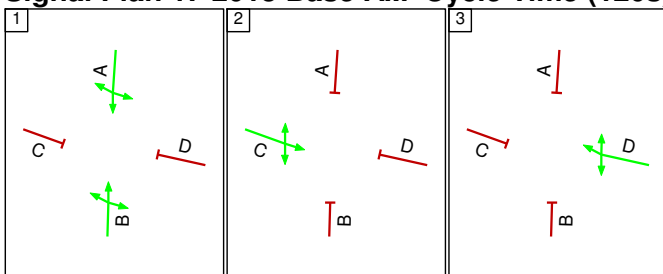
| | Starting Phase | | | |
|-------------------|----------------|---|---|---|
| | A | B | C | D |
| Terminating Phase | A | - | 7 | 7 |
| | B | - | 7 | 7 |
| | C | 7 | 7 | - |
| | D | 7 | 7 | 7 |
| | | | | |

Phase Diagram

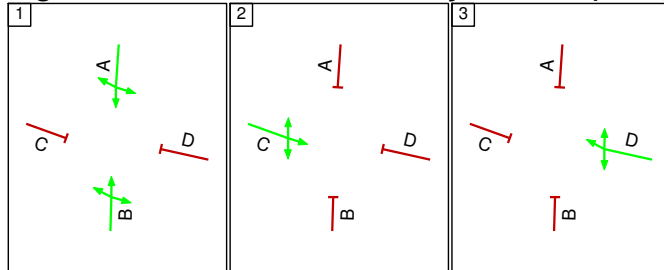


Stages Diagram

Signal Plan 1: '2013 Base AM' Cycle Time (120s)



Signal Plan 2: '2013 Base PM' Cycle Time (120s)



Signal Plans Data table

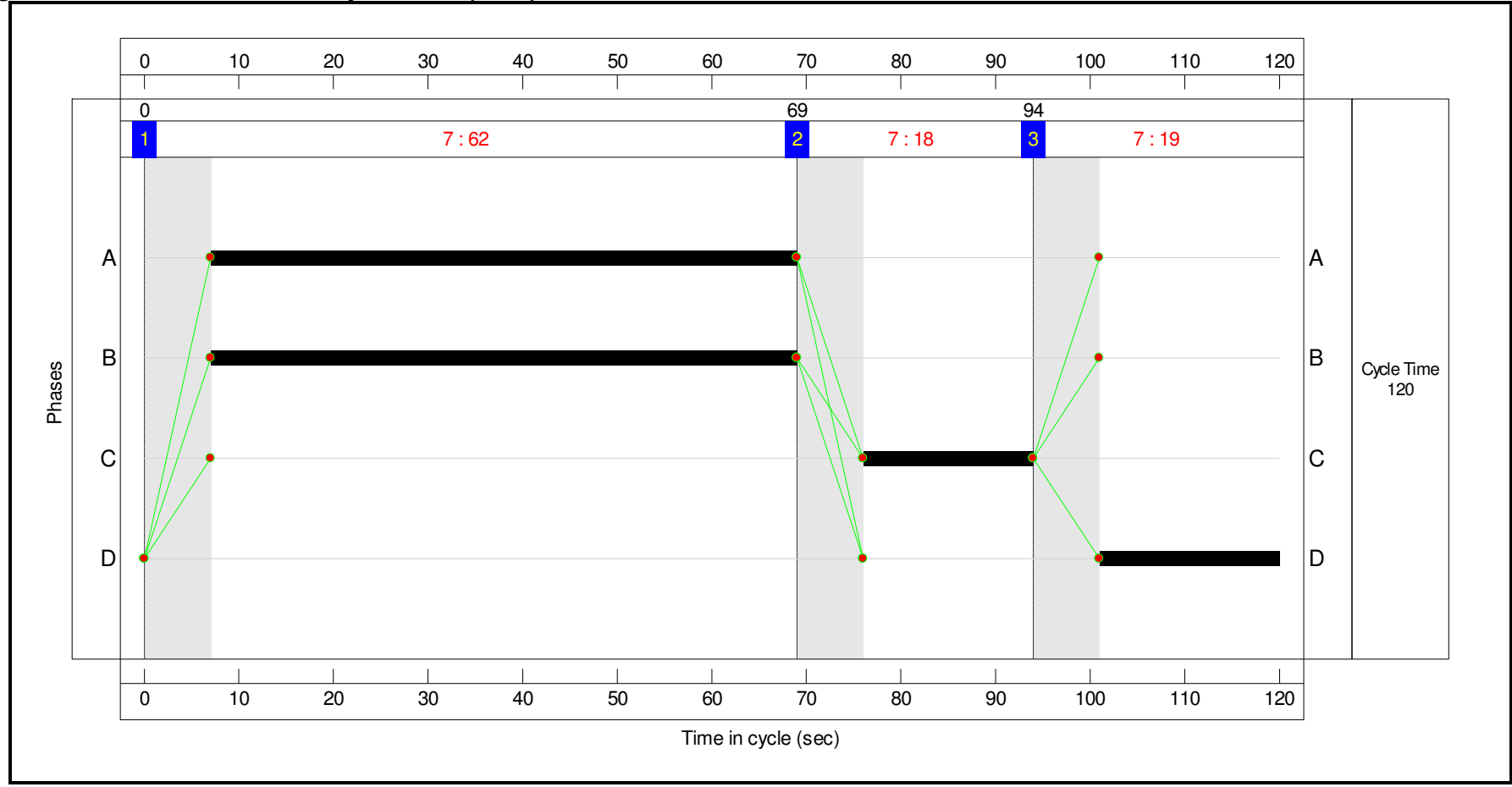
Signal Plan 1: '2013 Base AM' Cycle Time (120s)

| Stage | 1 | 2 | 3 |
|--------------|----|----|----|
| Duration | 62 | 18 | 19 |
| Change Point | 0 | 69 | 94 |

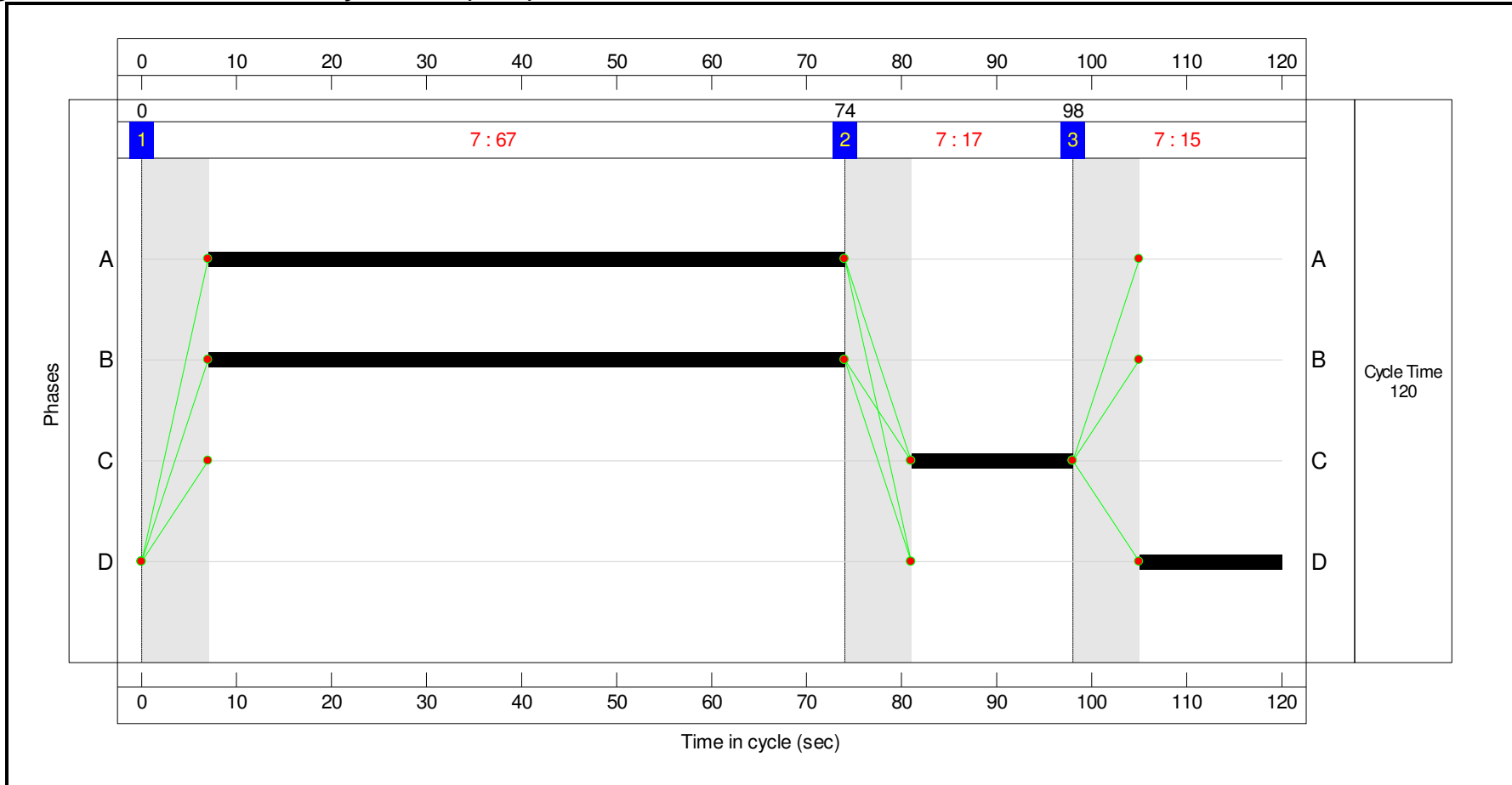
Signal Plan 2: '2013 Base PM' Cycle Time (120s)

| Stage | 1 | 2 | 3 |
|--------------|----|----|----|
| Duration | 67 | 17 | 15 |
| Change Point | 0 | 74 | 98 |

Signal Timings Diagram Signal Plan 1: '2013 Base AM' Cycle Time (120s)



Signal Plan 2: '2013 Base PM' Cycle Time (120s)



Traffic Flow Matrix

Flow Group 1: '2013 Base AM'

Desired Flow :

| | | Destination | | | | | Tot. |
|--------|------|-------------|-----|-----|-----|------|------|
| | | A | B | C | D | | |
| Origin | A | 0 | 525 | 14 | 40 | 579 | |
| | B | 249 | 0 | 45 | 59 | 353 | |
| | C | 8 | 65 | 0 | 207 | 280 | |
| | D | 82 | 71 | 122 | 0 | 275 | |
| | Tot. | 339 | 661 | 181 | 306 | 1487 | |

Flow Group 2: '2013 Base PM'

Desired Flow :

| | | Destination | | | | | Tot. |
|--------|------|-------------|-----|-----|-----|------|------|
| | | A | B | C | D | | |
| Origin | A | 0 | 280 | 10 | 41 | 331 | |
| | B | 415 | 0 | 38 | 175 | 628 | |
| | C | 22 | 57 | 0 | 187 | 266 | |
| | D | 28 | 56 | 143 | 0 | 227 | |
| | Tot. | 465 | 393 | 191 | 403 | 1452 | |

Traffic Flow Groups Data

| Flow Group | Start Time | End Time | Duration | Formula |
|-------------------|------------|----------|----------|---------|
| 1: '2013 Base AM' | 08:00 | 09:00 | 01:00 | |
| 2: '2013 Base PM' | 17:00 | 18:00 | 01:00 | |

Link Results**Scenario 1: '2013 Base AM'**

Signal Plan 1: '2013 Base AM' Cycle Time (120s)

Flow Group 1: '2013 Base AM'

| Link Num | Link Desc | Link Type | Deg Sat (%) | Mean Max Queue (pcu) | Full Phase | Arrow Phase | Total Green (s) | Demand Flow (pcu) | Max Sat Flow (pcu/Hr) | Ave Sat Flow (pcu/Hr) | Capacity (pcu) | |
|------------------------------|---------------------------------------|-----------|-------------|--|------------|-------------|-----------------|---------------------|-----------------------|-----------------------|----------------|--|
| 1/1 | B4030 (W/B) Left Ahead Right | U | 91.5 | 13.0 | D | | 19 | 275 | 1804 | 1804 | 301 | |
| 2/1 | B430 Ardley Road (S) Right Left Ahead | O | 85.6 | 9.8 | B | | 62 | 353 | 1904 | 786 | 413 | |
| 3/1 | B4030 (E/B) Ahead Right Left | U | 91.2 | 13.2 | C | | 18 | 280 | 1939 | 1939 | 307 | |
| 4/1 | B430 Ardley Road (N) Left Ahead Right | O | 95.9 | 25.1 | A | | 62 | 579 | 1969 | 1150 | 604 | |
| PRC for Signalled Links (%): | | | -6.5 | Total Delay for Signalled Links (pcuHr): | | | 33.16 | | | | | |
| PRC Over All Links (%): | | | -6.5 | Total Delay Over All Links(pcuHr): | | | 33.24 | Cycle Time (s): 120 | | | | |

Scenario 2: '2013 Base PM'

Signal Plan 2: '2013 Base PM' Cycle Time (120s)

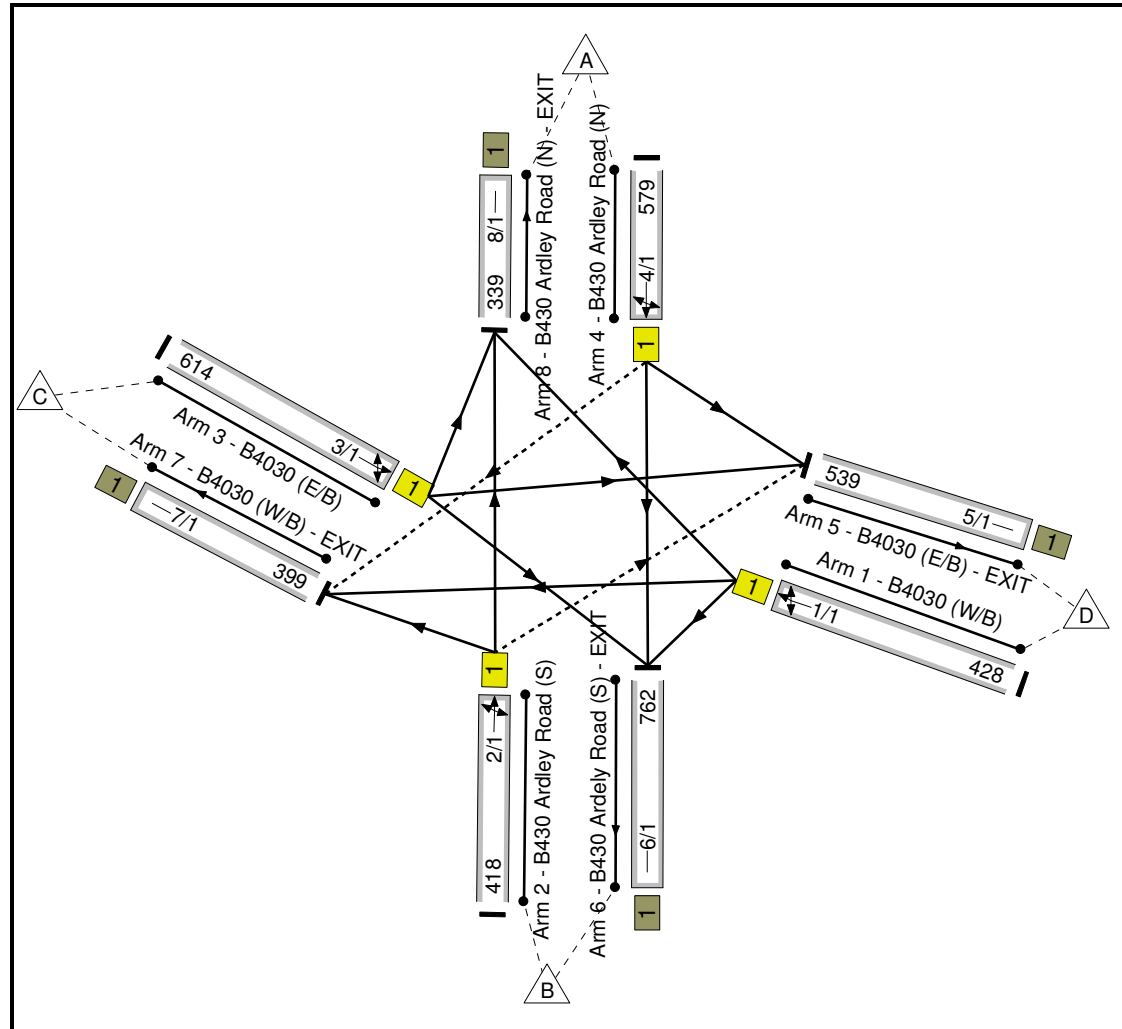
Flow Group 2: '2013 Base PM'

| Link Num | Link Desc | Link Type | Deg Sat (%) | Mean Max Queue (pcu) | Full Phase | Arrow Phase | Total Green (s) | Demand Flow (pcu) | Max Sat Flow (pcu/Hr) | Ave Sat Flow (pcu/Hr) | Capacity (pcu) | |
|------------------------------|---------------------------------------|-----------|-------------|--|------------|-------------|-----------------|---------------------|-----------------------|-----------------------|----------------|--|
| 1/1 | B4030 (W/B) Left Ahead Right | U | 93.0 | 11.8 | D | | 15 | 227 | 1831 | 1831 | 244 | |
| 2/1 | B430 Ardley Road (S) Right Left Ahead | O | 95.1 | 21.1 | B | | 67 | 628 | 1880 | 1165 | 660 | |
| 3/1 | B4030 (E/B) Ahead Right Left | U | 92.4 | 13.1 | C | | 17 | 266 | 1920 | 1920 | 288 | |
| 4/1 | B430 Ardley Road (N) Left Ahead Right | O | 92.3 | 14.8 | A | | 67 | 331 | 1957 | 633 | 358 | |
| PRC for Signalled Links (%): | | | -5.7 | Total Delay for Signalled Links (pcuHr): | | | 33.95 | | | | | |
| PRC Over All Links (%): | | | -5.7 | Total Delay Over All Links(pcuHr): | | | 34.02 | Cycle Time (s): 120 | | | | |

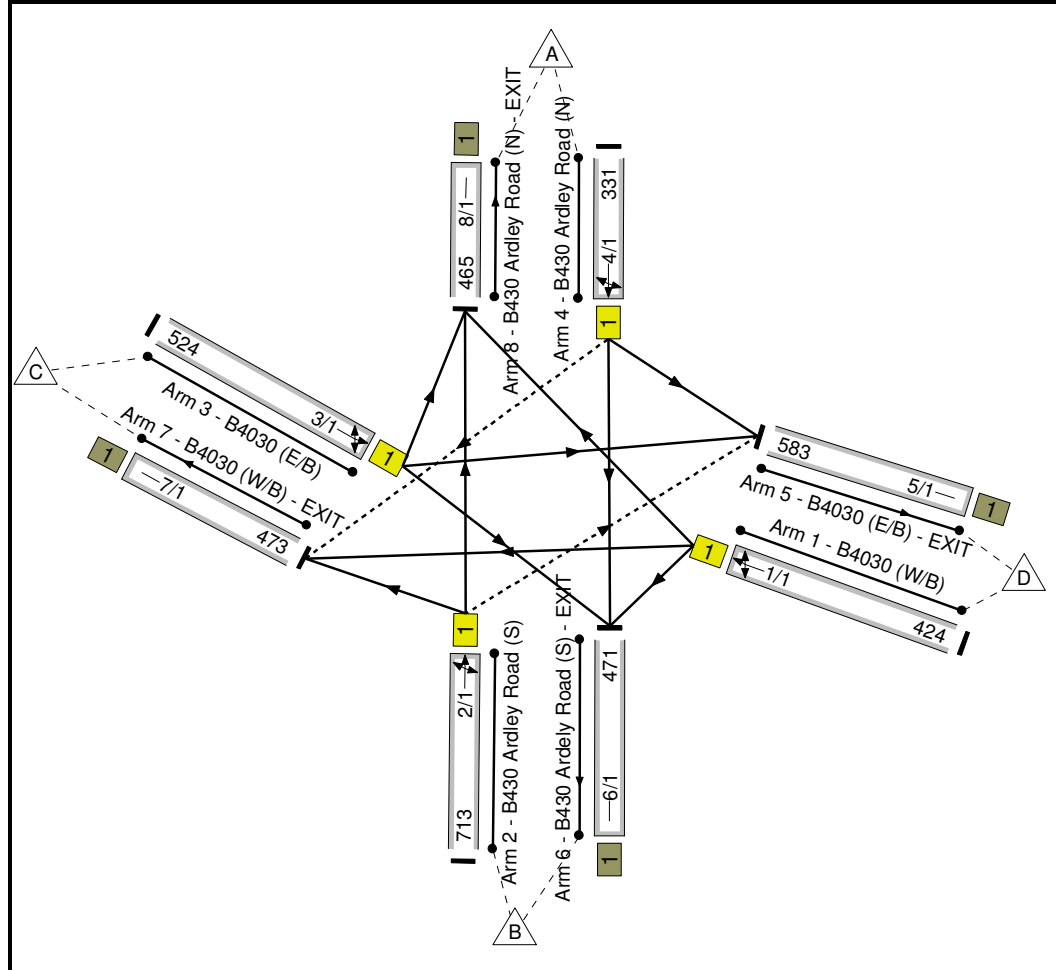
Middleton Stoney Jct 2013 Base + Gen

Junction Layout Diagram

Flow Group 1: '2013 Base + Gen AM'



Flow Group 2: '2013 Base + Gen PM'



Lane Data Table

| Arm/ Lane | Actual Length (PCU) | Effective Length (PCU) | Sat Flow Type | User Saturation Flow (PCU/Hr) | Lane Width (m) | Gradient | Nearside Lane | Allowed Turns | Turning Radius (m) |
|--------------------------------------|---------------------------|------------------------------|------------------|--|----------------------|----------|------------------|--|--------------------------|
| 1/1 (B4030 (W/B) Lane 1) | Inf | Inf | Geom | 1800 | 3.20 | 0.00 | Y | Arm 6 Left (B430 Ardely Road (S) - EXIT) | 17.50 |
| | | | | | | | | Arm 7 Ahead (B4030 (W/B) - EXIT) | 45.00 |
| | | | | | | | | Arm 8 Right (B430 Ardley Road (N) - EXIT) | 12.50 |
| 2/1 (B430 Ardley Road (S) Lane 1) | Inf | Inf | Geom | 1800 | 3.50 | 0.00 | Y | Arm 5 Right (B4030 (E/B) - EXIT) | 10.00 |
| | | | | | | | | Arm 7 Left (B4030 (W/B) - EXIT) | 27.50 |
| | | | | | | | | Arm 8 Ahead (B430 Ardley Road (N) - EXIT) | Inf |
| 3/1 (B4030 (E/B) Lane 1) | Inf | Inf | Geom | 1800 | 3.50 | 0.00 | Y | Arm 5 Ahead (B4030 (E/B) - EXIT) | Inf |
| | | | | | | | | Arm 6 Right (B430 Ardely Road (S) - EXIT) | 45.00 |
| | | | | | | | | Arm 8 Left (B430 Ardley Road (N) - EXIT) | 7.50 |
| 4/1 (B430 Ardley Road (N) Lane 1) | Inf | Inf | Geom | 1800 | 3.75 | 0.00 | Y | Arm 5 Left (B4030 (E/B) - EXIT) | 17.50 |
| | | | | | | | | Arm 6 Ahead (B430 Ardely Road (S) - EXIT) | Inf |
| | | | | | | | | Arm 7 Right (B4030 (W/B) - EXIT) | 7.50 |
| 5/1 (B4030 (E/B) - EXIT Lane 1) | Inf | Inf | User | 9999 | 3.25 | 0.00 | N | | |

| | | | | | | | | | |
|---|-----|-----|------|------|------|------|---|--|--|
| 6/1 (B430 Ardely Road (S) - EXIT Lane 1) | Inf | Inf | User | 9999 | 3.25 | 0.00 | N | | |
| 7/1 (B4030 (W/B) - EXIT Lane 1) | Inf | Inf | User | 9999 | 3.25 | 0.00 | N | | |
| 8/1 (B430 Ardley Road (N) - EXIT Lane 1) | Inf | Inf | User | 9999 | 3.25 | 0.00 | N | | |

Lane Data Table

Flow Group 1: '2013 Base + Gen AM'

| Arm/ Lane | Lane Width (m) | Gradient | Nearside Lane | Allowed Turns | Turning Radius (m) | Turning Prop. | Sat flow (PCU/Hr) |
|---|----------------------|----------|------------------|--|--------------------------|------------------|----------------------|
| 1/1 (B4030 (W/B) Lane 1) | 3.20 | 0.00 | Y | Arm 6 Left (B430 Ardely Road (S) - EXIT) | 17.50 | 16.6 % | 1828 |
| | | | | Arm 7 Ahead (B4030 (W/B) - EXIT) | 45.00 | 64.3 % | |
| | | | | Arm 8 Right (B430 Ardley Road (N) - EXIT) | 12.50 | 19.2 % | |
| 2/1 (B430 Ardley Road (S) Lane 1) | 3.50 | 0.00 | Y | Arm 5 Right (B4030 (E/B) - EXIT) | 10.00 | 14.1 % | 1898 |
| | | | | Arm 7 Left (B4030 (W/B) - EXIT) | 27.50 | 26.3 % | |
| | | | | Arm 8 Ahead (B430 Ardley Road (N) - EXIT) | Inf | 59.6 % | |
| 3/1 (B4030 (E/B) Lane 1) | 3.50 | 0.00 | Y | Arm 5 Ahead (B4030 (E/B) - EXIT) | Inf | 71.7 % | 1942 |
| | | | | Arm 6 Right (B430 Ardely Road (S) - EXIT) | 45.00 | 27.0 % | |
| 4/1 (B430 Ardley Road (N) Lane 1) | 3.75 | 0.00 | Y | Arm 8 Left (B430 Ardley Road (N) - EXIT) | 7.50 | 1.3 % | 1969 |
| | | | | Arm 5 Left (B4030 (E/B) - EXIT) | 17.50 | 6.9 % | |
| 5/1 (B4030 (E/B) - EXIT Lane 1) | | | | Arm 6 Ahead (B430 Ardely Road (S) - EXIT) | Inf | 90.7 % | 9999 |
| | | | | Arm 7 Right (B4030 (W/B) - EXIT) | 7.50 | 2.4 % | |
| This lane uses a directly entered Saturation Flow | | | | | | | 9999 |

| | | |
|---|--|-------------|
| <p>6/1 (B430 Ardely Road (S) - EXIT Lane 1)</p> | <p>This lane uses a directly entered Saturation Flow</p> | <p>9999</p> |
| <p>7/1 (B4030 (W/B) - EXIT Lane 1)</p> | <p>This lane uses a directly entered Saturation Flow</p> | <p>9999</p> |
| <p>8/1 (B430 Ardley Road (N) - EXIT Lane 1)</p> | <p>This lane uses a directly entered Saturation Flow</p> | <p>9999</p> |

Flow Group 2: '2013 Base + Gen PM'

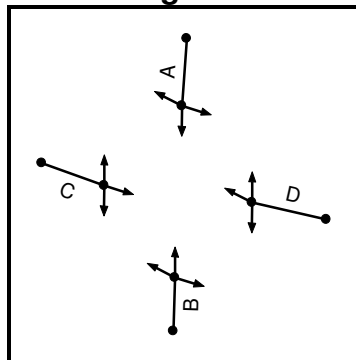
| Arm/ Lane | Lane Width (m) | Gradient | Nearside Lane | Allowed Turns | Turning Radius (m) | Turning Prop. | Sat flow (PCU/Hr) |
|--------------------------------------|---|----------|------------------|--|--------------------------|------------------|----------------------|
| 1/1 (B4030 (W/B) Lane 1) | 3.20 | 0.00 | Y | Arm 6 Left (B430 Ardely Road (S) - EXIT) | 17.50 | 13.2 % | 1850 |
| | | | | Arm 7 Ahead (B4030 (W/B) - EXIT) | 45.00 | 80.2 % | |
| | | | | Arm 8 Right (B430 Ardley Road (N) - EXIT) | 12.50 | 6.6 % | |
| 2/1 (B430 Ardley Road (S) Lane 1) | 3.50 | 0.00 | Y | Arm 5 Right (B4030 (E/B) - EXIT) | 10.00 | 24.5 % | 1878 |
| | | | | Arm 7 Left (B4030 (W/B) - EXIT) | 27.50 | 17.3 % | |
| | | | | Arm 8 Ahead (B430 Ardley Road (N) - EXIT) | Inf | 58.2 % | |
| 3/1 (B4030 (E/B) Lane 1) | 3.50 | 0.00 | Y | Arm 5 Ahead (B4030 (E/B) - EXIT) | Inf | 70.0 % | 1932 |
| | | | | Arm 6 Right (B430 Ardely Road (S) - EXIT) | 45.00 | 25.8 % | |
| | | | | Arm 8 Left (B430 Ardley Road (N) - EXIT) | 7.50 | 4.2 % | |
| 4/1 (B430 Ardley Road (N) Lane 1) | 3.75 | 0.00 | Y | Arm 5 Left (B4030 (E/B) - EXIT) | 17.50 | 12.4 % | 1957 |
| | | | | Arm 6 Ahead (B430 Ardely Road (S) - EXIT) | Inf | 84.6 % | |
| | | | | Arm 7 Right (B4030 (W/B) - EXIT) | 7.50 | 3.0 % | |
| 5/1 (B4030 (E/B) - EXIT Lane 1) | This lane uses a directly entered Saturation Flow | | | | | | 9999 |

| | | |
|---|---|------|
| 6/1 (B430 Ardely Road (S) - EXIT Lane 1) | This lane uses a directly entered Saturation Flow | 9999 |
| 7/1 (B4030 (W/B) - EXIT Lane 1) | This lane uses a directly entered Saturation Flow | 9999 |
| 8/1 (B430 Ardley Road (N) - EXIT Lane 1) | This lane uses a directly entered Saturation Flow | 9999 |

Intergreens Table

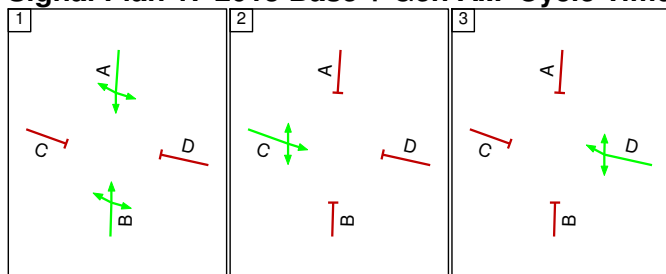
| | Starting Phase | | | |
|-------------------|----------------|---|---|---|
| | A | B | C | D |
| Terminating Phase | A | - | 7 | 7 |
| | B | - | 7 | 7 |
| | C | 7 | 7 | - |
| | D | 7 | 7 | 7 |
| | | | | |

Phase Diagram

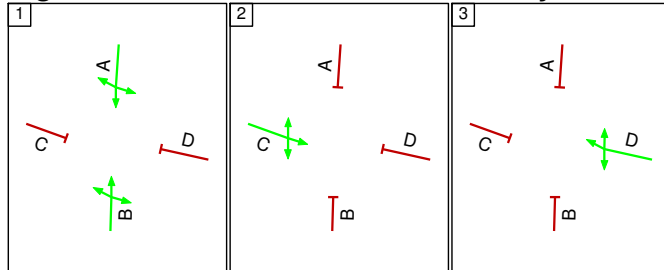


Stages Diagram

Signal Plan 1: '2013 Base + Gen AM' Cycle Time (120s)



Signal Plan 2: '2013 Base + Gen PM' Cycle Time (120s)



Signal Plans Data table

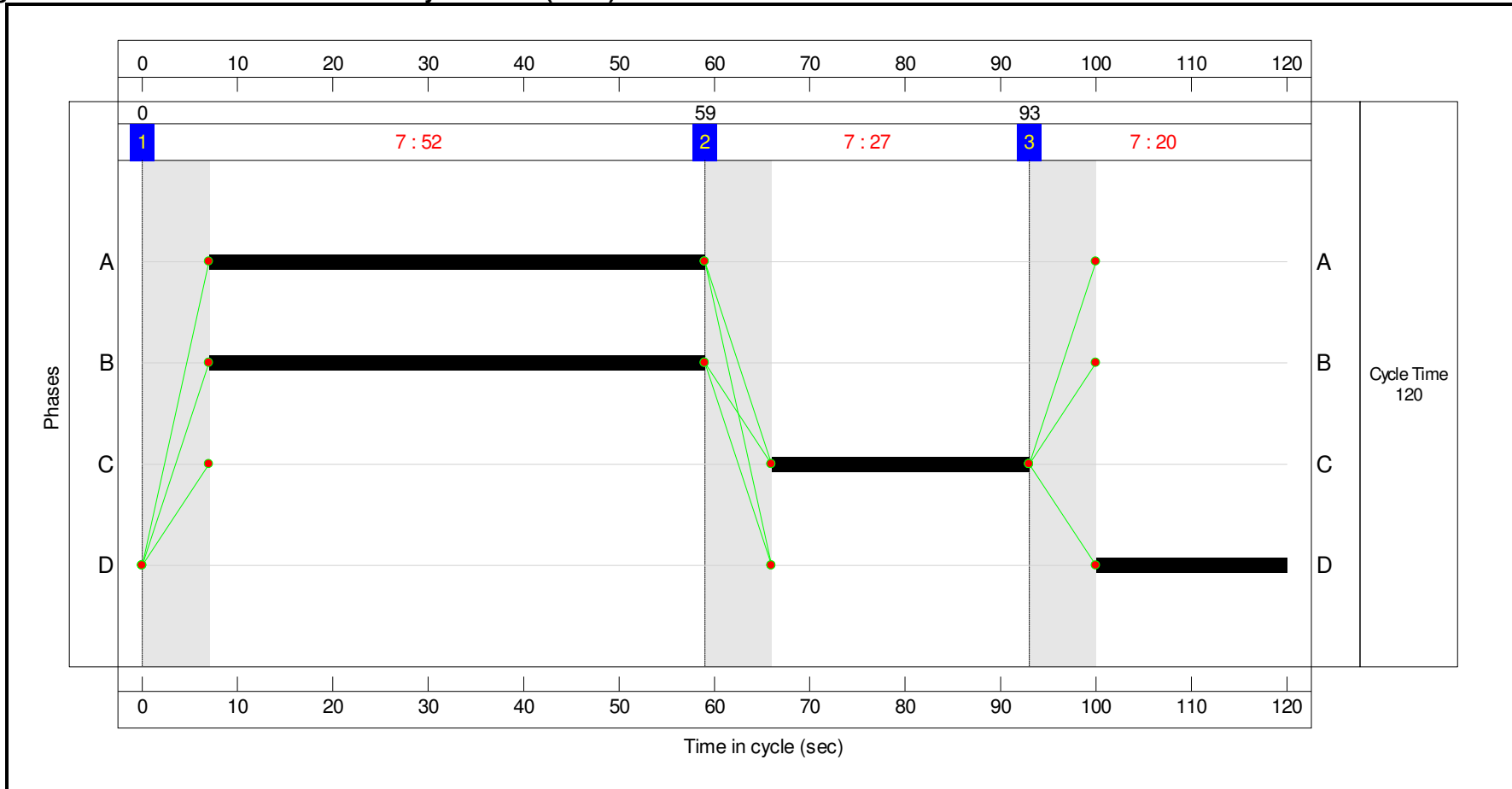
Signal Plan 1: '2013 Base + Gen AM' Cycle Time (120s)

| Stage | 1 | 2 | 3 |
|--------------|----|----|----|
| Duration | 52 | 27 | 20 |
| Change Point | 0 | 59 | 93 |

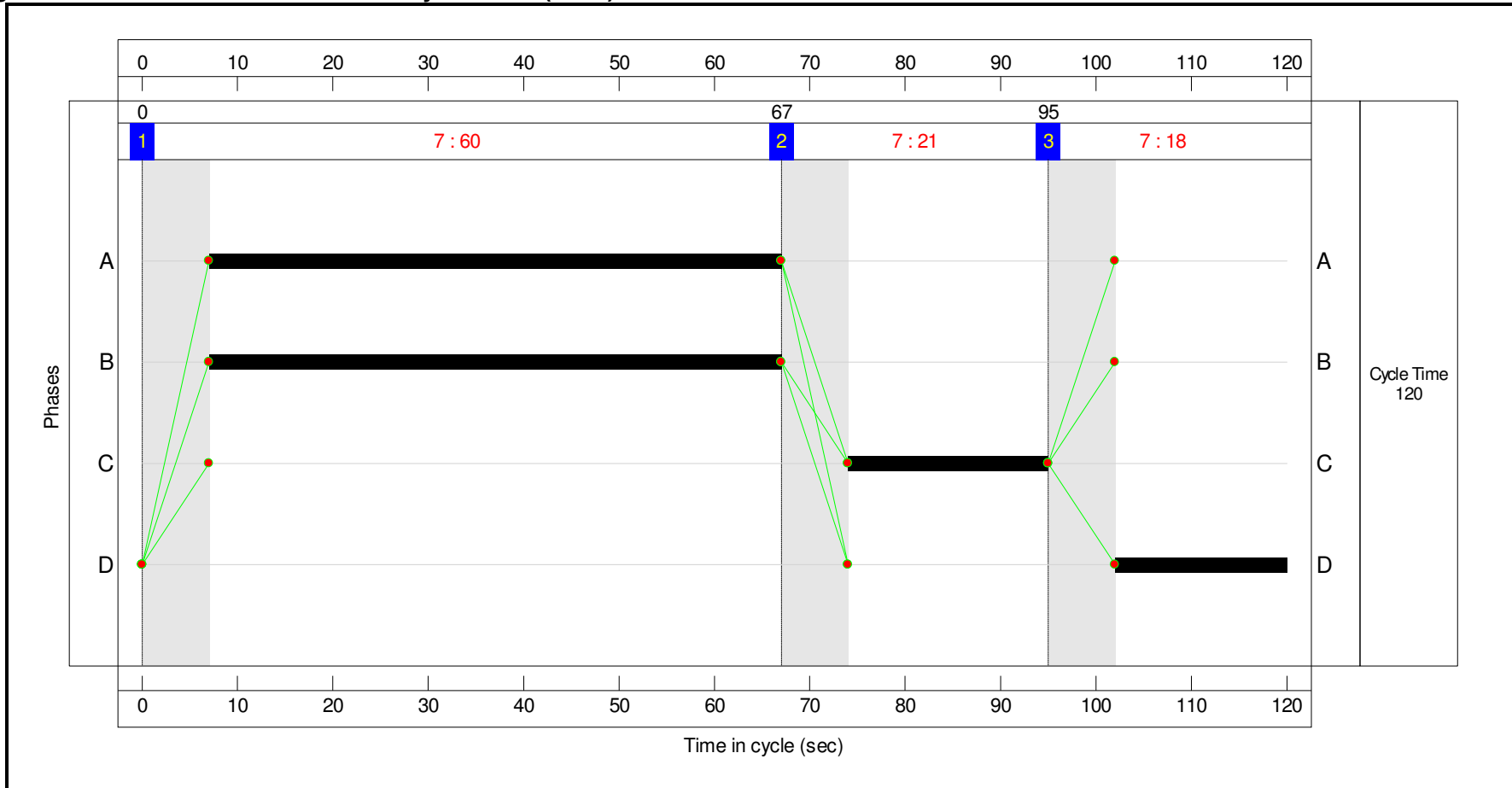
Signal Plan 2: '2013 Base + Gen PM' Cycle Time (120s)

| Stage | 1 | 2 | 3 |
|--------------|----|----|----|
| Duration | 60 | 21 | 18 |
| Change Point | 0 | 67 | 95 |

Signal Timings Diagram Signal Plan 1: '2013 Base + Gen AM' Cycle Time (120s)



Signal Plan 2: '2013 Base + Gen PM' Cycle Time (120s)



Traffic Flow Matrix

Flow Group 1: '2013 Base + Gen AM'

Desired Flow :

| | | Destination | | | | | Tot. |
|--------|------|-------------|-----|-----|-----|------|------|
| | | A | B | C | D | | |
| Origin | A | 0 | 525 | 14 | 40 | 579 | |
| | B | 249 | 0 | 110 | 59 | 418 | |
| | C | 8 | 166 | 0 | 440 | 614 | |
| | D | 82 | 71 | 275 | 0 | 428 | |
| | Tot. | 339 | 762 | 399 | 539 | 2039 | |

Flow Group 2: '2013 Base + Gen PM'

Desired Flow :

| | | Destination | | | | | Tot. |
|--------|------|-------------|-----|-----|-----|------|------|
| | | A | B | C | D | | |
| Origin | A | 0 | 280 | 10 | 41 | 331 | |
| | B | 415 | 0 | 123 | 175 | 713 | |
| | C | 22 | 135 | 0 | 367 | 524 | |
| | D | 28 | 56 | 340 | 0 | 424 | |
| | Tot. | 465 | 471 | 473 | 583 | 1992 | |

Traffic Flow Groups Data

| Flow Group | Start Time | End Time | Duration | Formula |
|-------------------------|------------|----------|----------|---------|
| 1: '2013 Base + Gen AM' | 08:00 | 09:00 | 01:00 | |
| 2: '2013 Base + Gen PM' | 17:00 | 18:00 | 01:00 | |

Link Results

Scenario 1: '2013 Base + Gen AM'

Signal Plan 1: '2013 Base + Gen AM' Cycle Time (120s)

Flow Group 1: '2013 Base + Gen AM'

| Link Num | Link Desc | Link Type | Deg Sat (%) | Mean Max Queue (pcu) | Full Phase | Arrow Phase | Total Green (s) | Demand Flow (pcu) | Max Sat Flow (pcu/Hr) | Ave Sat Flow (pcu/Hr) | Capacity (pcu) | |
|------------------------------|---------------------------------------|-----------|-------------|--|------------|-------------|-----------------|---------------------|-----------------------|-----------------------|----------------|--|
| 1/1 | B4030 (W/B) Left Ahead Right | U | 133.8 | 77.1 | D | | 20 | 428 | 1828 | 1828 | 320 | |
| 2/1 | B430 Ardley Road (S) Right Left Ahead | O | 118.2 | 50.2 | B | | 52 | 418 | 1898 | 801 | 354 | |
| 3/1 | B4030 (E/B) Ahead Right Left | U | 135.5 | 109.4 | C | | 27 | 614 | 1942 | 1942 | 453 | |
| 4/1 | B430 Ardley Road (N) Left Ahead Right | O | 131.9 | 95.0 | A | | 52 | 579 | 1969 | 994 | 439 | |
| PRC for Signalled Links (%): | | | -50.6 | Total Delay for Signalled Links (pcuHr): | | | 294.31 | | | | | |
| PRC Over All Links (%): | | | -50.6 | Total Delay Over All Links (pcuHr): | | | 294.39 | Cycle Time (s): 120 | | | | |

Scenario 2: '2013 Base + Gen PM'

Signal Plan 2: '2013 Base + Gen PM' Cycle Time (120s)

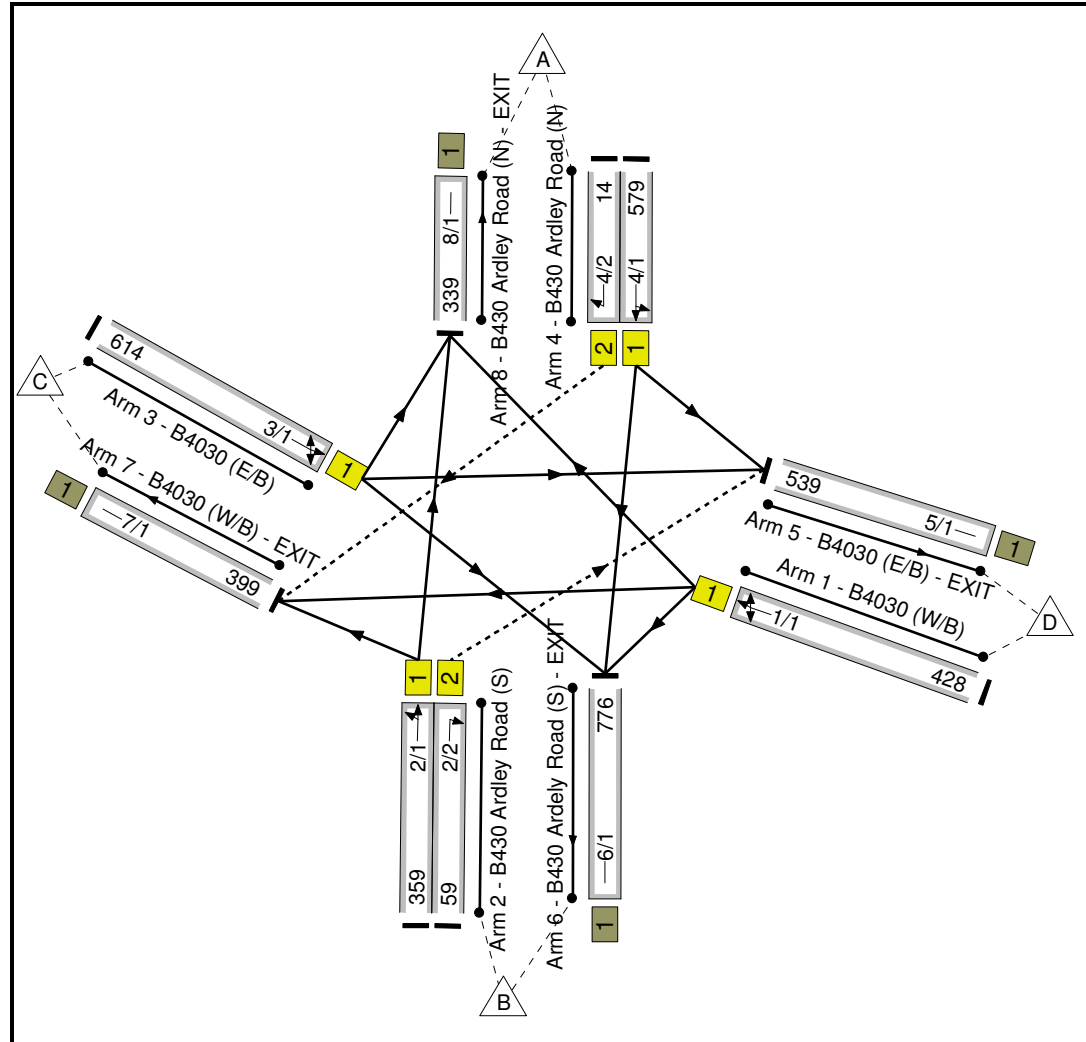
Flow Group 2: '2013 Base + Gen PM'

| Link Num | Link Desc | Link Type | Deg Sat (%) | Mean Max Queue (pcu) | Full Phase | Arrow Phase | Total Green (s) | Demand Flow (pcu) | Max Sat Flow (pcu/Hr) | Ave Sat Flow (pcu/Hr) | Capacity (pcu) | |
|------------------------------|---------------------------------------|-----------|-------------|--|------------|-------------|-----------------|---------------------|-----------------------|-----------------------|----------------|--|
| 1/1 | B4030 (W/B) Left Ahead Right | U | 144.8 | 89.6 | D | | 18 | 424 | 1850 | 1850 | 293 | |
| 2/1 | B430 Ardley Road (S) Right Left Ahead | O | 109.7 | 61.0 | B | | 60 | 713 | 1878 | 1278 | 650 | |
| 3/1 | B4030 (E/B) Ahead Right Left | U | 147.9 | 112.0 | C | | 21 | 524 | 1932 | 1932 | 354 | |
| 4/1 | B430 Ardley Road (N) Left Ahead Right | O | 146.6 | 68.3 | A | | 60 | 331 | 1957 | 444 | 226 | |
| PRC for Signalled Links (%): | | | -64.4 | Total Delay for Signalled Links (pcuHr): | | | 292.55 | | | | | |
| PRC Over All Links (%): | | | -64.4 | Total Delay Over All Links (pcuHr): | | | 292.63 | Cycle Time (s): 120 | | | | |

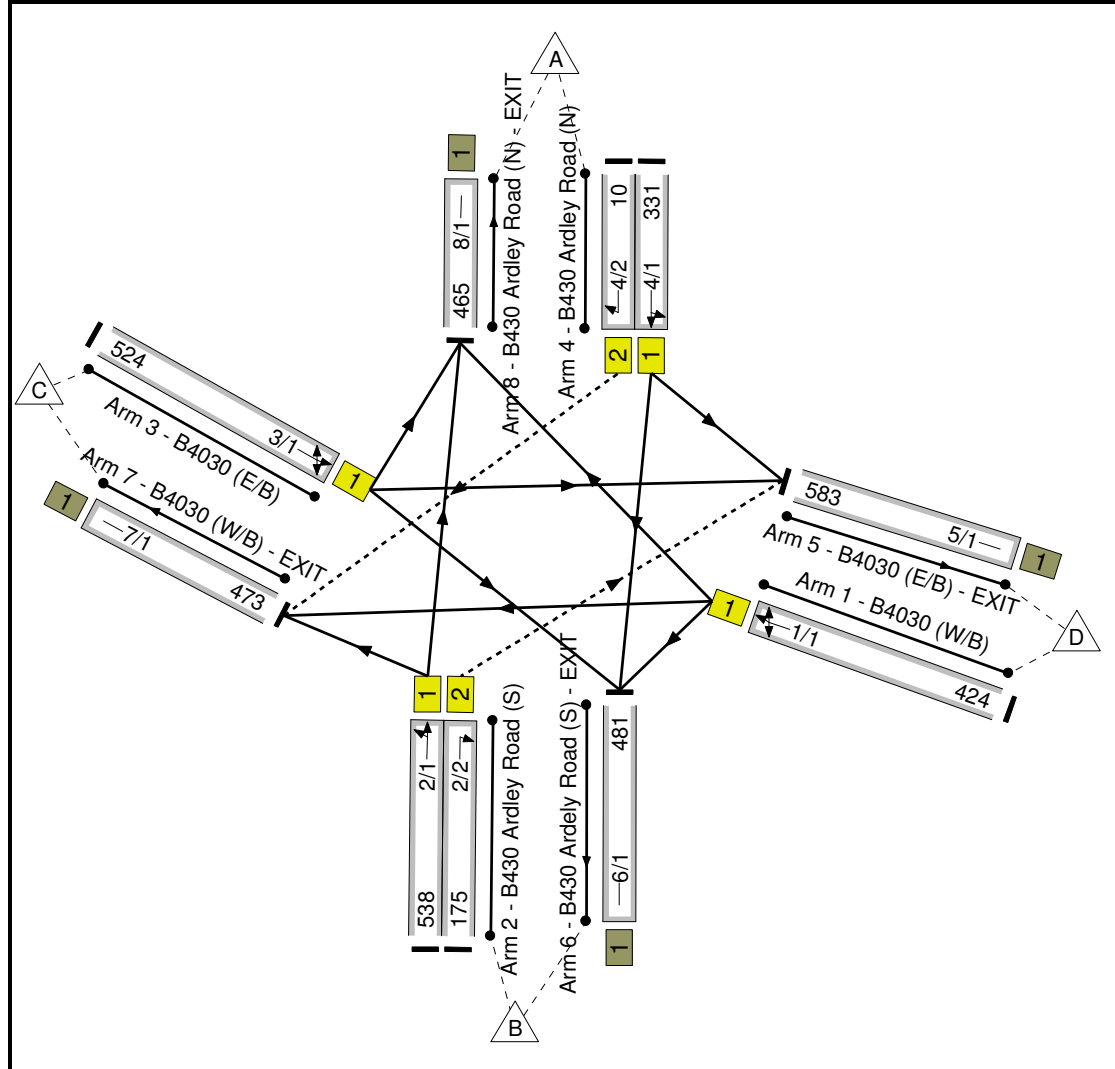
Middleton Stoney Jct 2013 Base + Gen (Proposed Staging) JI

Junction Layout Diagram

Flow Group 1: '2013 Base + Gen AM'



Flow Group 2: '2013 Base + Gen PM'



Lane Data Table

| Arm/ Lane | Actual Length (PCU) | Effective Length (PCU) | Sat Flow Type | User Saturation Flow (PCU/Hr) | Lane Width (m) | Gradient | Nearside Lane | Allowed Turns | Turning Radius (m) |
|--------------------------------------|---------------------------|------------------------------|------------------|--|----------------------|----------|------------------|--|--------------------------|
| 1/1 (B4030 (W/B) Lane 1) | Inf | Inf | Geom | 1800 | 3.50 | 0.00 | Y | Arm 6 Left (B430 Ardely Road (S) - EXIT) | 10.00 |
| | | | | | | | | Arm 7 Ahead (B4030 (W/B) - EXIT) | 22.50 |
| | | | | | | | | Arm 8 Right (B430 Ardley Road (N) - EXIT) | 22.50 |
| 2/1 (B430 Ardley Road (S) Lane 1) | Inf | Inf | Geom | 1800 | 3.00 | 0.00 | Y | Arm 7 Left (B4030 (W/B) - EXIT) | 45.00 |
| | | | | | | | | Arm 8 Ahead (B430 Ardley Road (N) - EXIT) | 54.00 |
| 2/2 (B430 Ardley Road (S) Lane 2) | Inf | Inf | Geom | 1800 | 3.00 | 0.00 | N | Arm 5 Right (B4030 (E/B) - EXIT) | 7.50 |
| 3/1 (B4030 (E/B) Lane 1) | Inf | Inf | Geom | 1800 | 3.00 | 0.00 | Y | Arm 5 Ahead (B4030 (E/B) - EXIT) | 15.00 |
| | | | | | | | | Arm 6 Right (B430 Ardely Road (S) - EXIT) | 35.00 |
| 4/1 (B430 Ardley Road (N) Lane 1) | Inf | Inf | Geom | 1800 | 3.00 | 0.00 | Y | Arm 8 Left (B430 Ardley Road (N) - EXIT) | 5.00 |
| | | | | | | | | Arm 5 Left (B4030 (E/B) - EXIT) | 15.00 |
| 4/2 (B430 Ardley Road (N) Lane 2) | Inf | Inf | Geom | 1800 | 3.00 | 0.00 | N | Arm 6 Ahead (B430 Ardely Road (S) - EXIT) | Inf |
| | | | | | | | | Arm 7 Right (B4030 (W/B) - EXIT) | 7.50 |
| 5/1 (B4030 (E/B) - EXIT Lane 1) | Inf | Inf | User | 9999 | 3.25 | 0.00 | N | | |

| | | | | | | | | | |
|---|-----|-----|------|------|------|------|---|--|--|
| 6/1 (B430 Ardely Road (S) - EXIT Lane 1) | Inf | Inf | User | 9999 | 3.25 | 0.00 | N | | |
| 7/1 (B4030 (W/B) - EXIT Lane 1) | Inf | Inf | User | 9999 | 3.25 | 0.00 | N | | |
| 8/1 (B430 Ardley Road (N) - EXIT Lane 1) | Inf | Inf | User | 9999 | 3.25 | 0.00 | N | | |

Lane Data Table**Flow Group 1: '2013 Base + Gen AM'**

| Arm/ Lane | Lane Width (m) | Gradient | Nearside Lane | Allowed Turns | Turning Radius (m) | Turning Prop. | Sat flow (PCU/Hr) |
|--------------------------------------|---|----------|------------------|--|--------------------------|------------------|----------------------|
| 1/1 (B4030 (W/B) Lane 1) | 3.50 | 0.00 | Y | Arm 6 Left (B430 Ardely Road (S) - EXIT) | 10.00 | 16.6 % | 1819 |
| | | | | Arm 7 Ahead (B4030 (W/B) - EXIT) | 22.50 | 64.3 % | |
| | | | | Arm 8 Right (B430 Ardley Road (N) - EXIT) | 22.50 | 19.2 % | |
| 2/1 (B430 Ardley Road (S) Lane 1) | 3.00 | 0.00 | Y | Arm 7 Left (B4030 (W/B) - EXIT) | 45.00 | 30.6 % | 1860 |
| | | | | Arm 8 Ahead (B430 Ardley Road (N) - EXIT) | 54.00 | 69.4 % | |
| 2/2 (B430 Ardley Road (S) Lane 2) | 3.00 | 0.00 | N | Arm 5 Right (B4030 (E/B) - EXIT) | 7.50 | 100.0 % | 1713 |
| 3/1 (B4030 (E/B) Lane 1) | 3.00 | 0.00 | Y | Arm 5 Ahead (B4030 (E/B) - EXIT) | 15.00 | 71.7 % | 1761 |
| | | | | Arm 6 Right (B430 Ardely Road (S) - EXIT) | 35.00 | 27.0 % | |
| 4/1 (B430 Ardley Road (N) Lane 1) | 3.00 | 0.00 | Y | Arm 8 Left (B430 Ardley Road (N) - EXIT) | 5.00 | 1.3 % | 1902 |
| | | | | Arm 5 Left (B4030 (E/B) - EXIT) | 15.00 | 6.9 % | |
| 4/2 (B430 Ardley Road (N) Lane 2) | 3.00 | 0.00 | N | Arm 6 Ahead (B430 Ardely Road (S) - EXIT) | Inf | 93.1 % | 1713 |
| | | | | Arm 7 Right (B4030 (W/B) - EXIT) | 7.50 | 100.0 % | |
| 5/1 (B4030 (E/B) - EXIT Lane 1) | This lane uses a directly entered Saturation Flow | | | | | | 9999 |

| | | |
|---|--|-------------|
| <p>6/1 (B430 Ardely Road (S) - EXIT Lane 1)</p> | <p>This lane uses a directly entered Saturation Flow</p> | <p>9999</p> |
| <p>7/1 (B4030 (W/B) - EXIT Lane 1)</p> | <p>This lane uses a directly entered Saturation Flow</p> | <p>9999</p> |
| <p>8/1 (B430 Ardley Road (N) - EXIT Lane 1)</p> | <p>This lane uses a directly entered Saturation Flow</p> | <p>9999</p> |

Flow Group 2: '2013 Base + Gen PM'

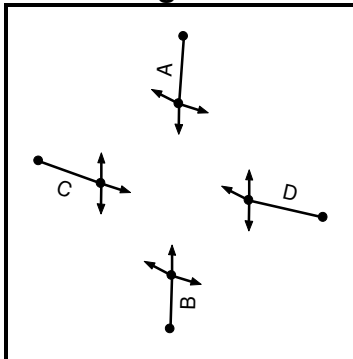
| Arm/ Lane | Lane Width (m) | Gradient | Nearside Lane | Allowed Turns | Turning Radius (m) | Turning Prop. | Sat flow (PCU/Hr) |
|--------------------------------------|---|----------|------------------|--|--------------------------|------------------|----------------------|
| 1/1 (B4030 (W/B) Lane 1) | 3.50 | 0.00 | Y | Arm 6 Left (B430 Ardely Road (S) - EXIT) | 10.00 | 13.2 % | 1823 |
| | | | | Arm 7 Ahead (B4030 (W/B) - EXIT) | 22.50 | 80.2 % | |
| | | | | Arm 8 Right (B430 Ardley Road (N) - EXIT) | 22.50 | 6.6 % | |
| 2/1 (B430 Ardley Road (S) Lane 1) | 3.00 | 0.00 | Y | Arm 7 Left (B4030 (W/B) - EXIT) | 45.00 | 22.9 % | 1861 |
| | | | | Arm 8 Ahead (B430 Ardley Road (N) - EXIT) | 54.00 | 77.1 % | |
| 2/2 (B430 Ardley Road (S) Lane 2) | 3.00 | 0.00 | N | Arm 5 Right (B4030 (E/B) - EXIT) | 7.50 | 100.0 % | 1713 |
| 3/1 (B4030 (E/B) Lane 1) | 3.00 | 0.00 | Y | Arm 5 Ahead (B4030 (E/B) - EXIT) | 15.00 | 70.0 % | 1751 |
| | | | | Arm 6 Right (B430 Ardely Road (S) - EXIT) | 35.00 | 25.8 % | |
| | | | | Arm 8 Left (B430 Ardley Road (N) - EXIT) | 5.00 | 4.2 % | |
| 4/1 (B430 Ardley Road (N) Lane 1) | 3.00 | 0.00 | Y | Arm 5 Left (B4030 (E/B) - EXIT) | 15.00 | 12.4 % | 1892 |
| | | | | Arm 6 Ahead (B430 Ardely Road (S) - EXIT) | Inf | 87.6 % | |
| 4/2 (B430 Ardley Road (N) Lane 2) | 3.00 | 0.00 | N | Arm 7 Right (B4030 (W/B) - EXIT) | 7.50 | 100.0 % | 1713 |
| 5/1 (B4030 (E/B) - EXIT Lane 1) | This lane uses a directly entered Saturation Flow | | | | | | 9999 |

| | | |
|---|--|-------------|
| <p>6/1 (B430 Ardely Road (S) - EXIT Lane 1)</p> | <p>This lane uses a directly entered Saturation Flow</p> | <p>9999</p> |
| <p>7/1 (B4030 (W/B) - EXIT Lane 1)</p> | <p>This lane uses a directly entered Saturation Flow</p> | <p>9999</p> |
| <p>8/1 (B430 Ardley Road (N) - EXIT Lane 1)</p> | <p>This lane uses a directly entered Saturation Flow</p> | <p>9999</p> |

Intergreens Table

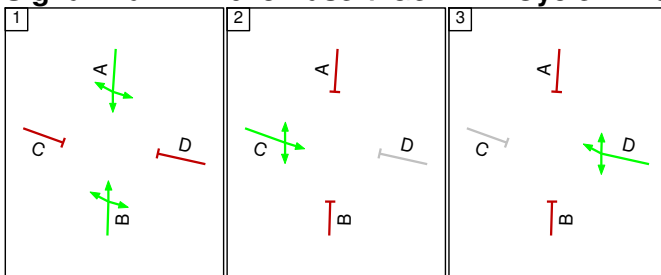
| | | Starting Phase | | | |
|-------------------|---|----------------|---|---|---|
| | | A | B | C | D |
| Terminating Phase | A | | | 6 | 8 |
| | B | - | | 7 | 5 |
| | C | 5 | 6 | | - |
| | D | 7 | 5 | - | |
| | | | | | |

Phase Diagram

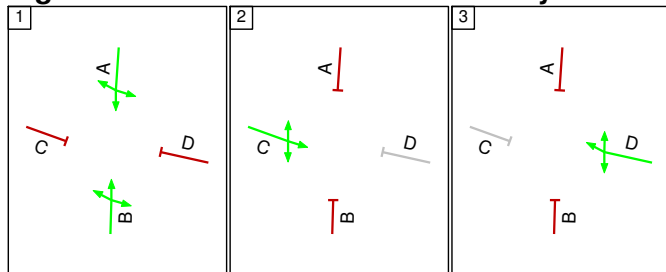


Stages Diagram

Signal Plan 1: '2013 Base + Gen AM' Cycle Time (120s)



Signal Plan 2: '2013 Base + Gen PM' Cycle Time (120s)



Signal Plans Data table

Signal Plan 1: '2013 Base + Gen AM' Cycle Time (120s)

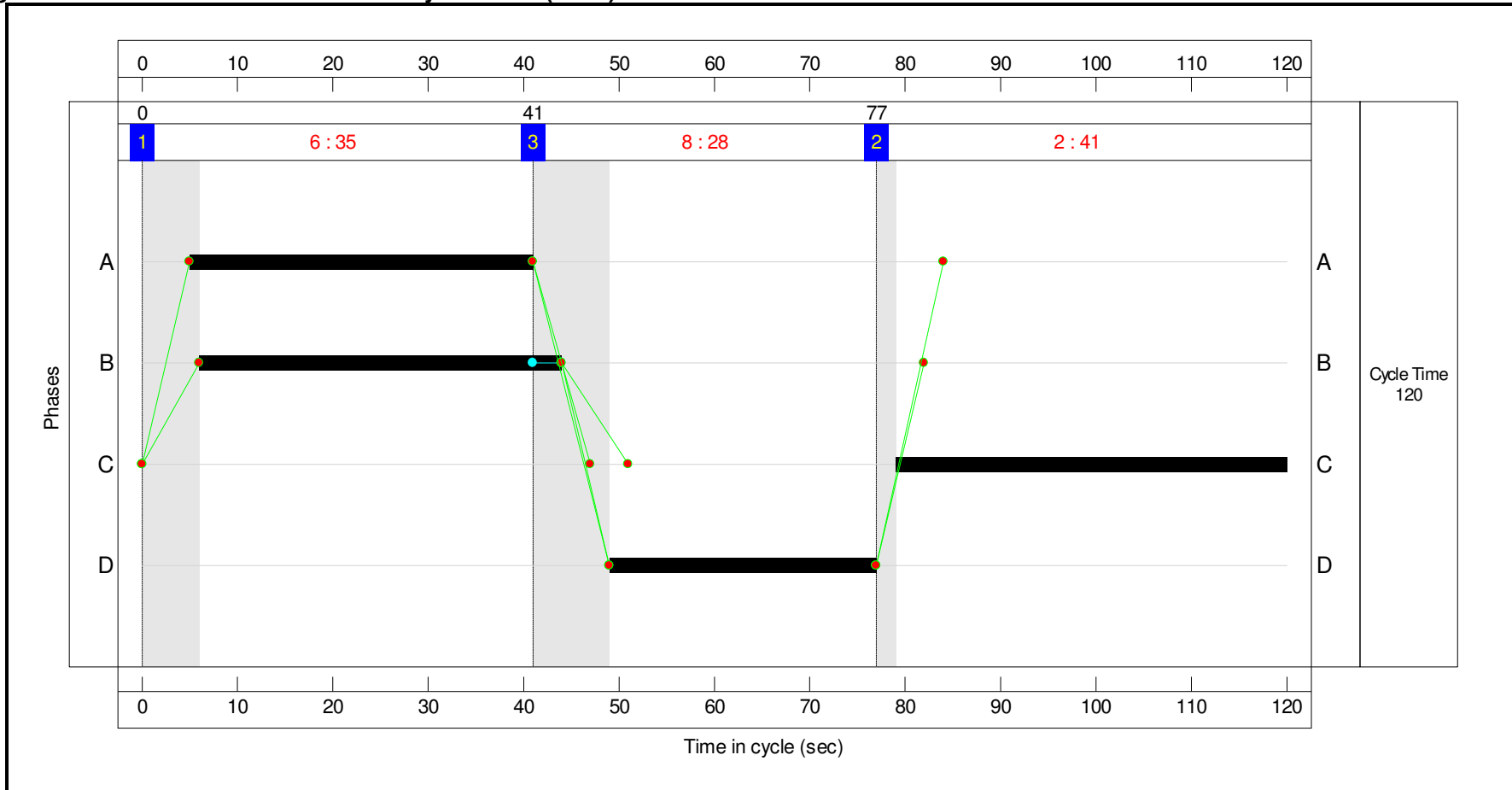
| Stage | 1 | 3 | 2 |
|--------------|----|----|----|
| Duration | 35 | 28 | 41 |
| Change Point | 0 | 41 | 77 |

Signal Plan 2: '2013 Base + Gen PM' Cycle Time (120s)

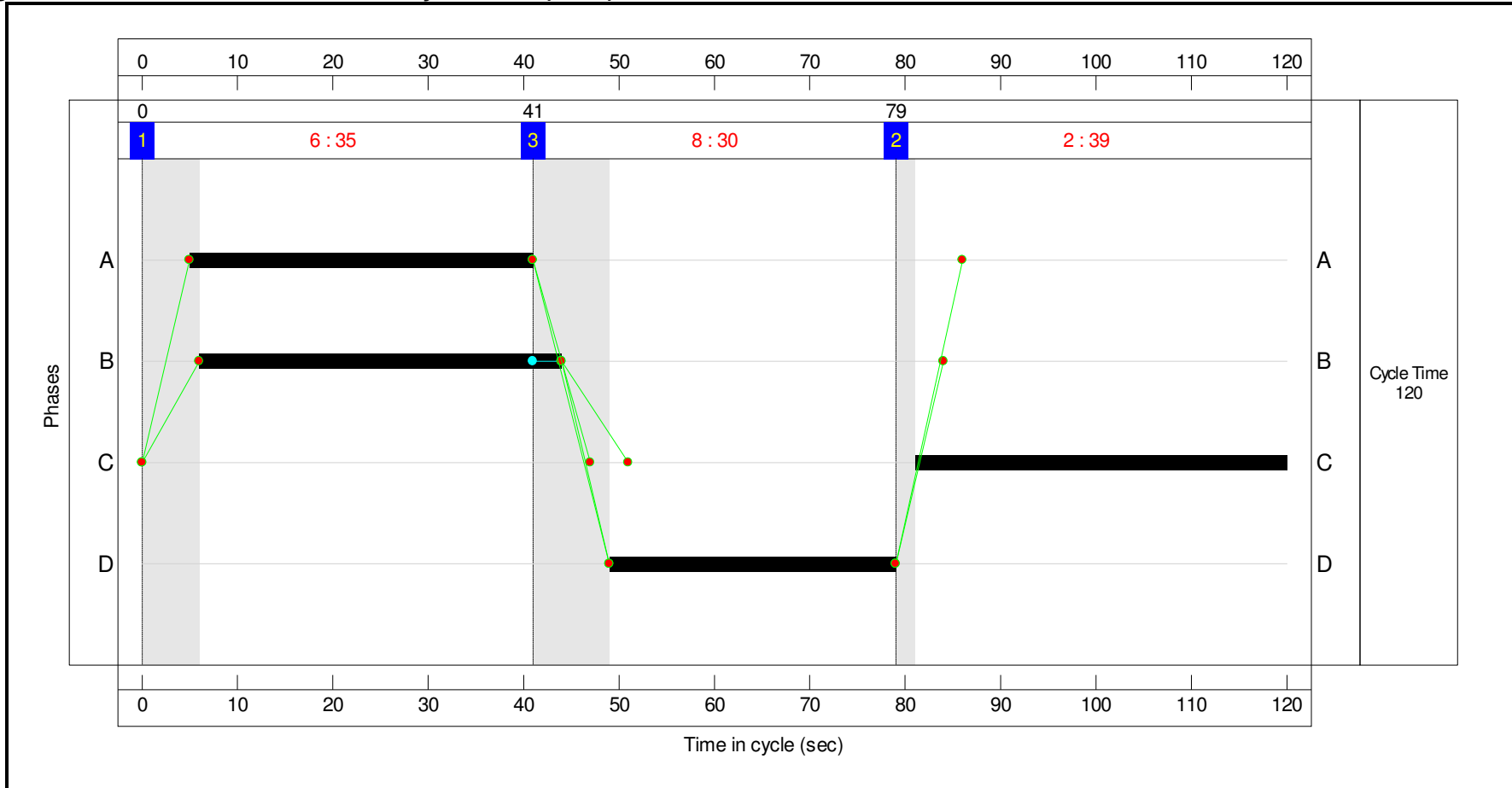
| Stage | 1 | 3 | 2 |
|--------------|----|----|----|
| Duration | 35 | 30 | 39 |
| Change Point | 0 | 41 | 79 |

Signal Timings Diagram

Signal Plan 1: '2013 Base + Gen AM' Cycle Time (120s)



Signal Plan 2: '2013 Base + Gen PM' Cycle Time (120s)



Traffic Flow Matrix

Flow Group 1: '2013 Base + Gen AM'

Desired Flow :

| | | Destination | | | | | Tot. |
|--------|------|-------------|-----|-----|-----|------|------|
| | | A | B | C | D | | |
| Origin | A | 0 | 539 | 14 | 40 | 593 | |
| | B | 249 | 0 | 110 | 59 | 418 | |
| | C | 8 | 166 | 0 | 440 | 614 | |
| | D | 82 | 71 | 275 | 0 | 428 | |
| | Tot. | 339 | 776 | 399 | 539 | 2053 | |

Flow Group 2: '2013 Base + Gen PM'

Desired Flow :

| | | Destination | | | | | Tot. |
|--------|------|-------------|-----|-----|-----|------|------|
| | | A | B | C | D | | |
| Origin | A | 0 | 290 | 10 | 41 | 341 | |
| | B | 415 | 0 | 123 | 175 | 713 | |
| | C | 22 | 135 | 0 | 367 | 524 | |
| | D | 28 | 56 | 340 | 0 | 424 | |
| | Tot. | 465 | 481 | 473 | 583 | 2002 | |

Traffic Flow Groups Data

| Flow Group | Start Time | End Time | Duration | Formula |
|-------------------------|------------|----------|----------|---------|
| 1: '2013 Base + Gen AM' | 08:00 | 09:00 | 01:00 | |
| 2: '2013 Base + Gen PM' | 17:00 | 18:00 | 01:00 | |

Link Results

Scenario 1: '2013 Base + Gen AM'

Signal Plan 1: '2013 Base + Gen AM' Cycle Time (120s)

Flow Group 1: '2013 Base + Gen AM'

| Link Num | Link Desc | Link Type | Deg Sat (%) | Mean Max Queue (pcu) | Full Phase | Arrow Phase | Total Green (s) | Demand Flow (pcu) | Max Sat Flow (pcu/Hr) | Ave Sat Flow (pcu/Hr) | Capacity (pcu) | |
|------------------------------|---------------------------------|-----------|-------------|--|------------|-------------|-----------------|---------------------|-----------------------|-----------------------|----------------|--|
| 1/1 | B4030 (W/B) Left Ahead Right | U | 97.4 | 21.9 | D | | 28 | 428 | 1819 | 1819 | 440 | |
| 2/1 | B430 Ardley Road (S) Left Ahead | O | 59.4 | 10.7 | B | | 38 | 359 | 1860 | 1860 | 604 | |
| 2/2 | B430 Ardley Road (S) Right | O | 65.6 | 2.3 | B | | 38 | 59 | 1713 | 277 | 90 | |
| 3/1 | B4030 (E/B) Ahead Right Left | U | 99.6 | 32.1 | C | | 41 | 614 | 1761 | 1761 | 616 | |
| 4/1 | B430 Ardley Road (N) Left Ahead | O | 98.7 | 29.5 | A | | 36 | 579 | 1902 | 1902 | 586 | |
| 4/2 | B430 Ardley Road (N) Right | O | 9.3 | 0.4 | A | | 36 | 14 | 1713 | 490 | 151 | |
| PRC for Signalled Links (%): | | | -10.7 | Total Delay for Signalled Links (pcuHr): | | | 54.83 | | | | | |
| PRC Over All Links (%): | | | -10.7 | Total Delay Over All Links(pcuHr): | | | 54.94 | Cycle Time (s): 120 | | | | |

Scenario 2: '2013 Base + Gen PM'

Signal Plan 2: '2013 Base + Gen PM' Cycle Time (120s)

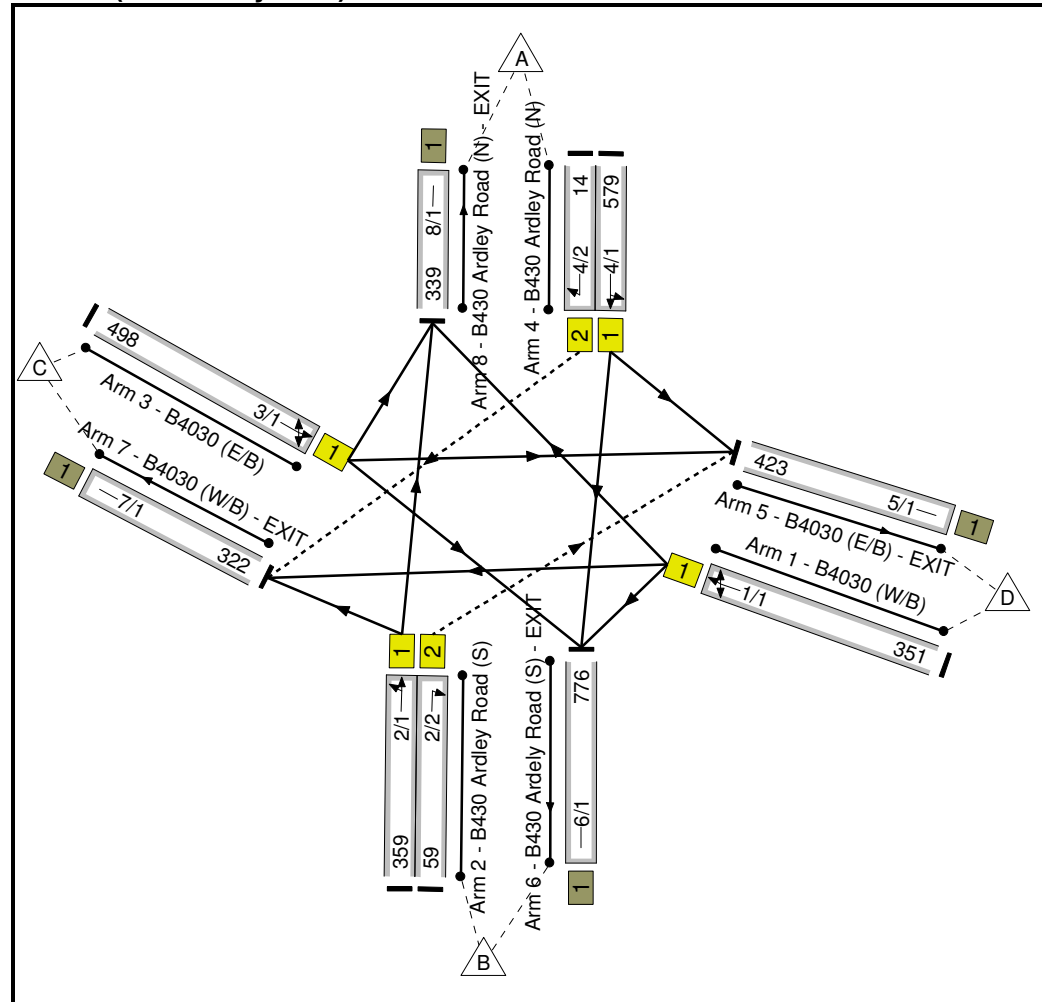
Flow Group 2: '2013 Base + Gen PM'

| Link Num | Link Desc | Link Type | Deg Sat (%) | Mean Max Queue (pcu) | Full Phase | Arrow Phase | Total Green (s) | Demand Flow (pcu) | Max Sat Flow (pcu/Hr) | Ave Sat Flow (pcu/Hr) | Capacity (pcu) | |
|------------------------------|---------------------------------|-----------|-------------|--|------------|-------------|-----------------|---------------------|-----------------------|-----------------------|----------------|--|
| 1/1 | B4030 (W/B) Left Ahead Right | U | 90.0 | 17.4 | D | | 30 | 424 | 1823 | 1823 | 471 | |
| 2/1 | B430 Ardley Road (S) Left Ahead | O | 89.0 | 20.5 | B | | 38 | 538 | 1861 | 1861 | 605 | |
| 2/2 | B430 Ardley Road (S) Right | O | 65.1 | 6.2 | B | | 38 | 175 | 1713 | 827 | 269 | |
| 3/1 | B4030 (E/B) Ahead Right Left | U | 89.8 | 20.5 | C | | 39 | 524 | 1751 | 1751 | 584 | |
| 4/1 | B430 Ardley Road (N) Left Ahead | O | 56.7 | 9.8 | A | | 36 | 331 | 1892 | 1892 | 583 | |
| 4/2 | B430 Ardley Road (N) Right | O | 33.3 | 0.5 | A | | 36 | 10 | 1713 | 97 | 30 | |
| PRC for Signalled Links (%): | | | -0.0 | Total Delay for Signalled Links (pcuHr): | | | 35.21 | | | | | |
| PRC Over All Links (%): | | | -0.0 | Total Delay Over All Links (pcuHr): | | | 35.31 | Cycle Time (s): 120 | | | | |

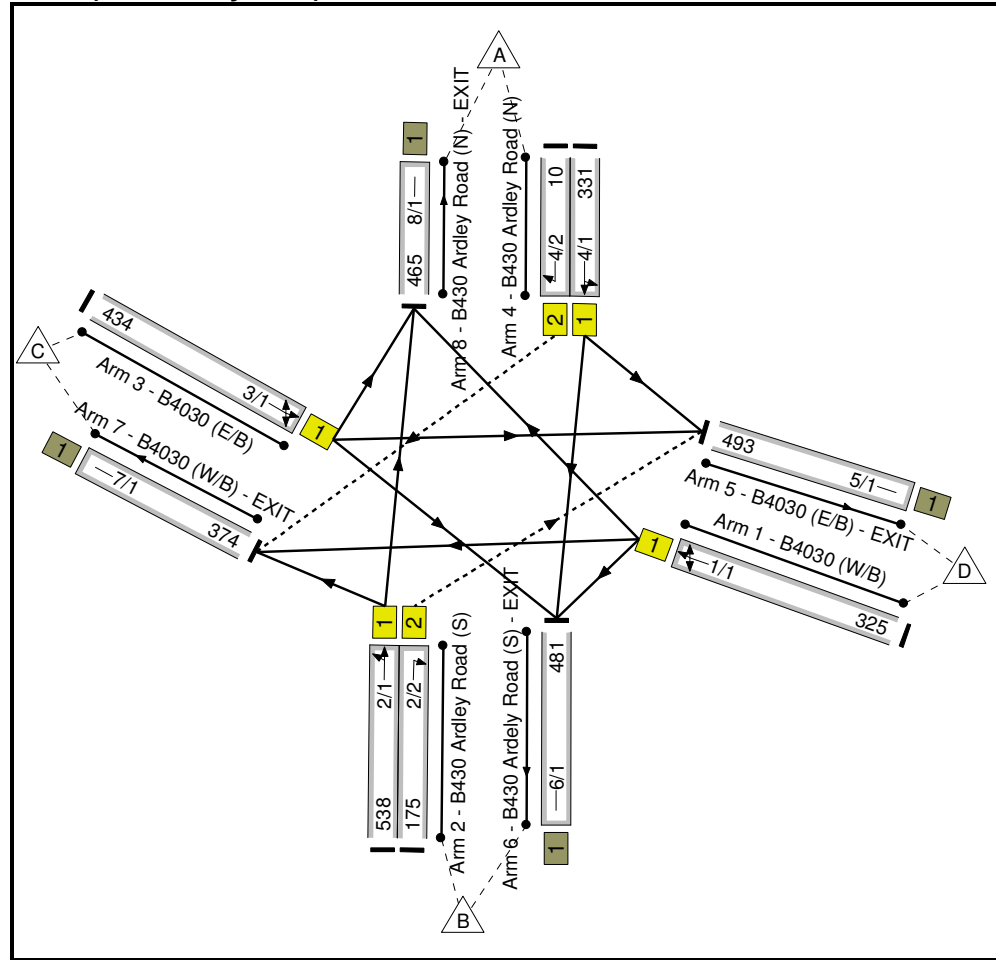
Middleton Stoney Jct 2013 Base + Gen (Proposed Staging) Sensitivity Test JI

Junction Layout Diagram

Flow Group 1: '2013 Base + Gen AM (Sensitivity Test)'



Flow Group 2: '2013 Base + Gen PM (Sensitivity Test)'



Lane Data Table

| Arm/ Lane | Actual Length (PCU) | Effective Length (PCU) | Sat Flow Type | User Saturation Flow (PCU/Hr) | Lane Width (m) | Gradient | Nearside Lane | Allowed Turns | Turning Radius (m) |
|--------------------------------------|---------------------------|------------------------------|------------------|--|----------------------|----------|------------------|--|--------------------------|
| 1/1 (B4030 (W/B) Lane 1) | Inf | Inf | Geom | 1800 | 3.50 | 0.00 | Y | Arm 6 Left (B430 Ardely Road (S) - EXIT) | 10.00 |
| | | | | | | | | Arm 7 Ahead (B4030 (W/B) - EXIT) | 22.50 |
| | | | | | | | | Arm 8 Right (B430 Ardley Road (N) - EXIT) | 22.50 |
| 2/1 (B430 Ardley Road (S) Lane 1) | Inf | Inf | Geom | 1800 | 3.00 | 0.00 | Y | Arm 7 Left (B4030 (W/B) - EXIT) | 45.00 |
| | | | | | | | | Arm 8 Ahead (B430 Ardley Road (N) - EXIT) | 54.00 |
| 2/2 (B430 Ardley Road (S) Lane 2) | Inf | Inf | Geom | 1800 | 3.00 | 0.00 | N | Arm 5 Right (B4030 (E/B) - EXIT) | 7.50 |
| 3/1 (B4030 (E/B) Lane 1) | Inf | Inf | Geom | 1800 | 3.00 | 0.00 | Y | Arm 5 Ahead (B4030 (E/B) - EXIT) | 15.00 |
| | | | | | | | | Arm 6 Right (B430 Ardely Road (S) - EXIT) | 35.00 |
| 4/1 (B430 Ardley Road (N) Lane 1) | Inf | Inf | Geom | 1800 | 3.00 | 0.00 | Y | Arm 8 Left (B430 Ardley Road (N) - EXIT) | 5.00 |
| | | | | | | | | Arm 5 Left (B4030 (E/B) - EXIT) | 15.00 |
| 4/2 (B430 Ardley Road (N) Lane 2) | Inf | Inf | Geom | 1800 | 3.00 | 0.00 | N | Arm 6 Ahead (B430 Ardely Road (S) - EXIT) | Inf |
| | | | | | | | | Arm 7 Right (B4030 (W/B) - EXIT) | 7.50 |
| 5/1 (B4030 (E/B) - EXIT Lane 1) | Inf | Inf | User | 9999 | 3.25 | 0.00 | N | | |

| | | | | | | | | | |
|---|-----|-----|------|------|------|------|---|--|--|
| 6/1 (B430 Ardely Road (S) - EXIT Lane 1) | Inf | Inf | User | 9999 | 3.25 | 0.00 | N | | |
| 7/1 (B4030 (W/B) - EXIT Lane 1) | Inf | Inf | User | 9999 | 3.25 | 0.00 | N | | |
| 8/1 (B430 Ardley Road (N) - EXIT Lane 1) | Inf | Inf | User | 9999 | 3.25 | 0.00 | N | | |

Lane Data Table**Flow Group 1: '2013 Base + Gen AM (Sensitivity Test)'**

| Arm/ Lane | Lane Width (m) | Gradient | Nearside Lane | Allowed Turns | Turning Radius (m) | Turning Prop. | Sat flow (PCU/Hr) |
|--------------------------------------|---|----------|------------------|--|--------------------------|------------------|----------------------|
| 1/1 (B4030 (W/B) Lane 1) | 3.50 | 0.00 | Y | Arm 6 Left (B430 Ardely Road (S) - EXIT) | 10.00 | 20.2 % | 1814 |
| | | | | Arm 7 Ahead (B4030 (W/B) - EXIT) | 22.50 | 56.4 % | |
| | | | | Arm 8 Right (B430 Ardley Road (N) - EXIT) | 22.50 | 23.4 % | |
| 2/1 (B430 Ardley Road (S) Lane 1) | 3.00 | 0.00 | Y | Arm 7 Left (B4030 (W/B) - EXIT) | 45.00 | 30.6 % | 1860 |
| | | | | Arm 8 Ahead (B430 Ardley Road (N) - EXIT) | 54.00 | 69.4 % | |
| 2/2 (B430 Ardley Road (S) Lane 2) | 3.00 | 0.00 | N | Arm 5 Right (B4030 (E/B) - EXIT) | 7.50 | 100.0 % | 1713 |
| 3/1 (B4030 (E/B) Lane 1) | 3.00 | 0.00 | Y | Arm 5 Ahead (B4030 (E/B) - EXIT) | 15.00 | 65.1 % | 1766 |
| | | | | Arm 6 Right (B430 Ardely Road (S) - EXIT) | 35.00 | 33.3 % | |
| 4/1 (B430 Ardley Road (N) Lane 1) | 3.00 | 0.00 | Y | Arm 8 Left (B430 Ardley Road (N) - EXIT) | 5.00 | 1.6 % | 1902 |
| | | | | Arm 5 Left (B4030 (E/B) - EXIT) | 15.00 | 6.9 % | |
| 4/2 (B430 Ardley Road (N) Lane 2) | 3.00 | 0.00 | N | Arm 6 Ahead (B430 Ardely Road (S) - EXIT) | Inf | 93.1 % | 1713 |
| | | | | Arm 7 Right (B4030 (W/B) - EXIT) | 7.50 | 100.0 % | |
| 5/1 (B4030 (E/B) - EXIT Lane 1) | This lane uses a directly entered Saturation Flow | | | | | | 9999 |

| | | |
|---|---|------|
| 6/1 (B430 Ardely Road (S) - EXIT Lane 1) | This lane uses a directly entered Saturation Flow | 9999 |
| 7/1 (B4030 (W/B) - EXIT Lane 1) | This lane uses a directly entered Saturation Flow | 9999 |
| 8/1 (B430 Ardley Road (N) - EXIT Lane 1) | This lane uses a directly entered Saturation Flow | 9999 |

Flow Group 2: '2013 Base + Gen PM (Sensitivity Test)'

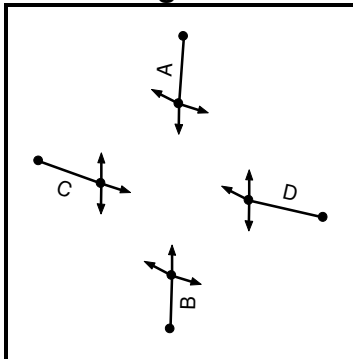
| Arm/ Lane | Lane Width (m) | Gradient | Nearside Lane | Allowed Turns | Turning Radius (m) | Turning Prop. | Sat flow (PCU/Hr) |
|--------------------------------------|---|----------|------------------|--|--------------------------|------------------|----------------------|
| 1/1 (B4030 (W/B) Lane 1) | 3.50 | 0.00 | Y | Arm 6 Left (B430 Ardely Road (S) - EXIT) | 10.00 | 17.2 % | 1818 |
| | | | | Arm 7 Ahead (B4030 (W/B) - EXIT) | 22.50 | 74.2 % | |
| | | | | Arm 8 Right (B430 Ardley Road (N) - EXIT) | 22.50 | 8.6 % | |
| 2/1 (B430 Ardley Road (S) Lane 1) | 3.00 | 0.00 | Y | Arm 7 Left (B4030 (W/B) - EXIT) | 45.00 | 22.9 % | 1861 |
| | | | | Arm 8 Ahead (B430 Ardley Road (N) - EXIT) | 54.00 | 77.1 % | |
| 2/2 (B430 Ardley Road (S) Lane 2) | 3.00 | 0.00 | N | Arm 5 Right (B4030 (E/B) - EXIT) | 7.50 | 100.0 % | 1713 |
| 3/1 (B4030 (E/B) Lane 1) | 3.00 | 0.00 | Y | Arm 5 Ahead (B4030 (E/B) - EXIT) | 15.00 | 63.8 % | 1753 |
| | | | | Arm 6 Right (B430 Ardely Road (S) - EXIT) | 35.00 | 31.1 % | |
| | | | | Arm 8 Left (B430 Ardley Road (N) - EXIT) | 5.00 | 5.1 % | |
| 4/1 (B430 Ardley Road (N) Lane 1) | 3.00 | 0.00 | Y | Arm 5 Left (B4030 (E/B) - EXIT) | 15.00 | 12.4 % | 1892 |
| | | | | Arm 6 Ahead (B430 Ardely Road (S) - EXIT) | Inf | 87.6 % | |
| 4/2 (B430 Ardley Road (N) Lane 2) | 3.00 | 0.00 | N | Arm 7 Right (B4030 (W/B) - EXIT) | 7.50 | 100.0 % | 1713 |
| 5/1 (B4030 (E/B) - EXIT Lane 1) | This lane uses a directly entered Saturation Flow | | | | | | 9999 |

| | | |
|---|---|------|
| 6/1 (B430 Ardely Road (S) - EXIT Lane 1) | This lane uses a directly entered Saturation Flow | 9999 |
| 7/1 (B4030 (W/B) - EXIT Lane 1) | This lane uses a directly entered Saturation Flow | 9999 |
| 8/1 (B430 Ardley Road (N) - EXIT Lane 1) | This lane uses a directly entered Saturation Flow | 9999 |

Intergreens Table

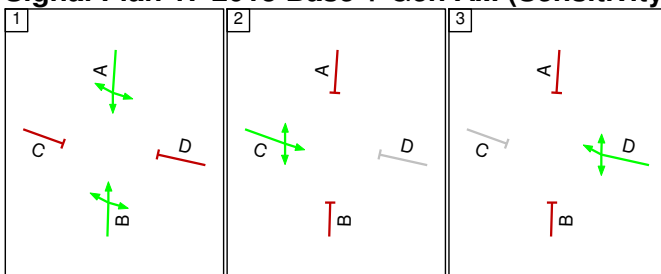
| | | Starting Phase | | | |
|-------------------|---|----------------|---|---|---|
| | | A | B | C | D |
| Terminating Phase | A | | | | |
| | B | | | | |
| | C | | | | |
| | D | | | | |
| | | | | | |
| | | 6 | 8 | 7 | 5 |
| | | 5 | 6 | - | - |
| | | 7 | 5 | - | - |

Phase Diagram

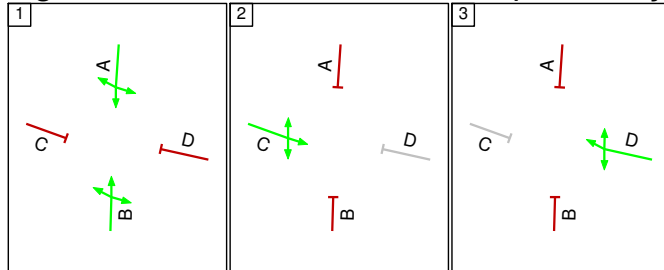


Stages Diagram

Signal Plan 1: '2013 Base + Gen AM (Sensitivity Test)' Cycle Time (120s)



Signal Plan 2: '2013 Base + Gen PM (Sensitivity Test)' Cycle Time (120s)



Signal Plans Data table

Signal Plan 1: '2013 Base + Gen AM (Sensitivity Test)' Cycle Time (120s)

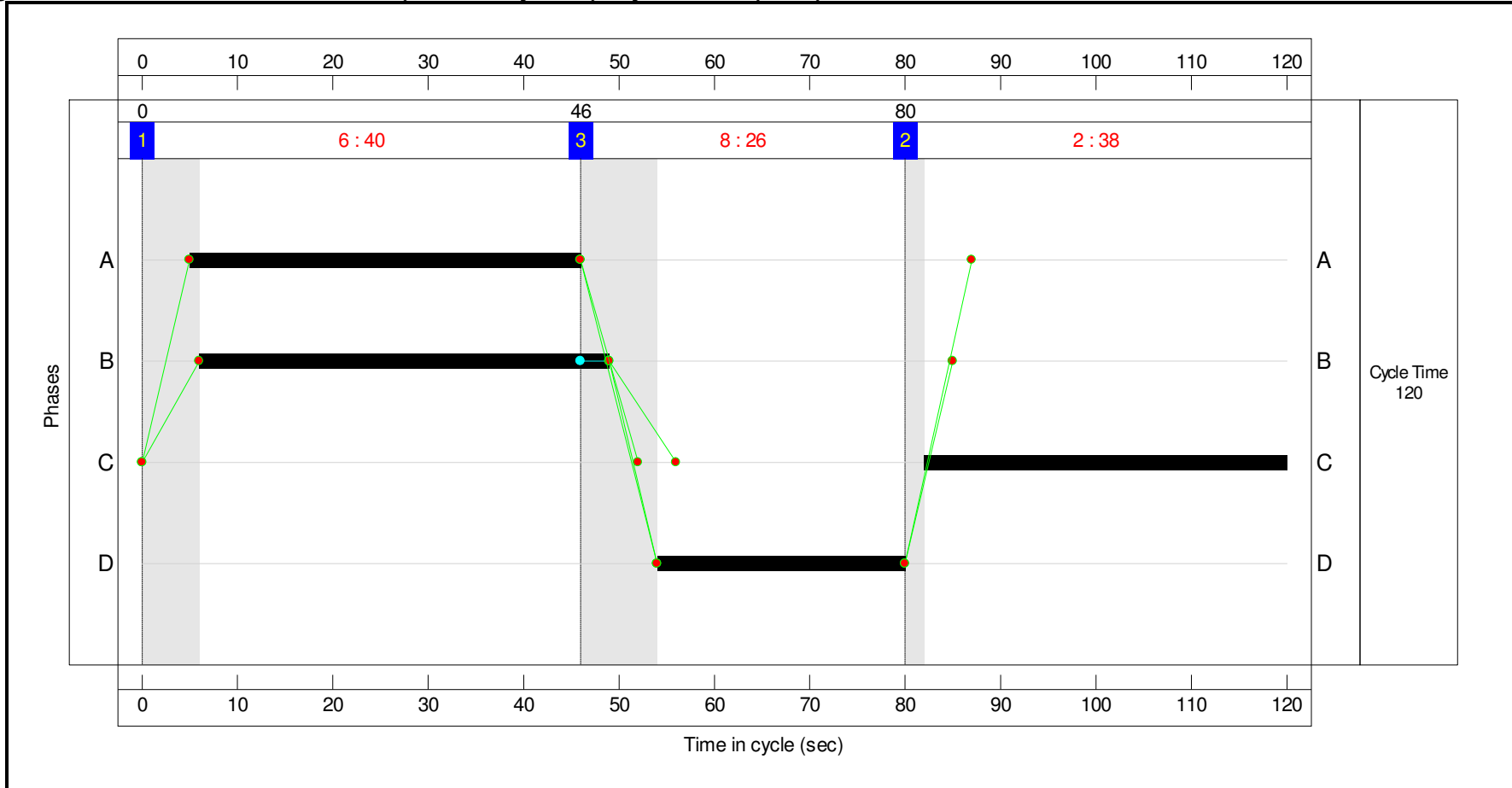
| Stage | 1 | 3 | 2 |
|--------------|----|----|----|
| Duration | 40 | 26 | 38 |
| Change Point | 0 | 46 | 80 |

Signal Plan 2: '2013 Base + Gen PM (Sensitivity Test)' Cycle Time (120s)

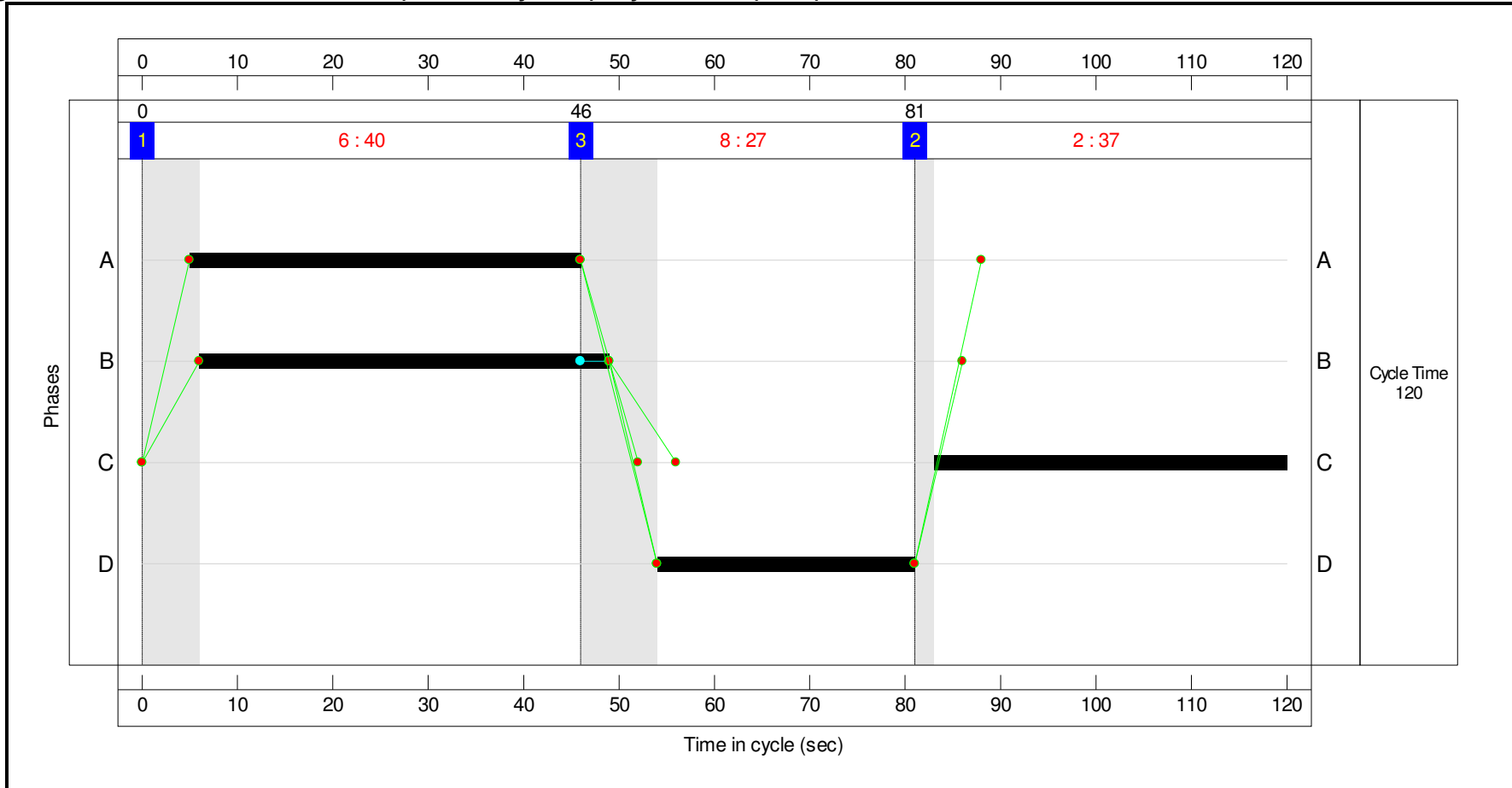
| Stage | 1 | 3 | 2 |
|--------------|----|----|----|
| Duration | 40 | 27 | 37 |
| Change Point | 0 | 46 | 81 |

Signal Timings Diagram

Signal Plan 1: '2013 Base + Gen AM (Sensitivity Test)' Cycle Time (120s)



Signal Plan 2: '2013 Base + Gen PM (Sensitivity Test)' Cycle Time (120s)



Traffic Flow Matrix

Flow Group 1: '2013 Base + Gen AM (Sensitivity Test)'

Desired Flow :

| | | Destination | | | | | Tot. |
|--------|------|-------------|-----|-----|-----|------|------|
| | | A | B | C | D | | |
| Origin | A | 0 | 539 | 14 | 40 | 593 | |
| | B | 249 | 0 | 110 | 59 | 418 | |
| | C | 8 | 166 | 0 | 324 | 498 | |
| | D | 82 | 71 | 198 | 0 | 351 | |
| | Tot. | 339 | 776 | 322 | 423 | 1860 | |

Flow Group 2: '2013 Base + Gen PM (Sensitivity Test)'

Desired Flow :

| | | Destination | | | | | Tot. |
|--------|------|-------------|-----|-----|-----|------|------|
| | | A | B | C | D | | |
| Origin | A | 0 | 290 | 10 | 41 | 341 | |
| | B | 415 | 0 | 123 | 175 | 713 | |
| | C | 22 | 135 | 0 | 277 | 434 | |
| | D | 28 | 56 | 241 | 0 | 325 | |
| | Tot. | 465 | 481 | 374 | 493 | 1813 | |

Traffic Flow Groups Data

| Flow Group | Start Time | End Time | Duration | Formula |
|--|------------|----------|----------|---------|
| 1: '2013 Base + Gen AM (Sensitivity Test)' | 08:00 | 09:00 | 01:00 | |
| 2: '2013 Base + Gen PM (Sensitivity Test)' | 17:00 | 18:00 | 01:00 | |

Link Results

Scenario 1: '2013 Base + Gen AM (Sensitivity Test)'

Signal Plan 1: '2013 Base + Gen AM (Sensitivity Test)' Cycle Time (120s)

Flow Group 1: '2013 Base + Gen AM (Sensitivity Test)'

| Link Num | Link Desc | Link Type | Deg Sat (%) | Mean Max Queue (pcu) | Full Phase | Arrow Phase | Total Green (s) | Demand Flow (pcu) | Max Sat Flow (pcu/Hr) | Ave Sat Flow (pcu/Hr) | Capacity (pcu) | |
|------------------------------|---------------------------------|-----------|-------------|--|------------|-------------|-----------------|---------------------|-----------------------|-----------------------|----------------|--|
| 1/1 | B4030 (W/B) Left Ahead Right | U | 86.0 | 14.0 | D | | 26 | 351 | 1814 | 1814 | 408 | |
| 2/1 | B430 Ardley Road (S) Left Ahead | O | 52.6 | 9.9 | B | | 43 | 359 | 1860 | 1860 | 682 | |
| 2/2 | B430 Ardley Road (S) Right | O | 38.3 | 1.6 | B | | 43 | 59 | 1713 | 420 | 154 | |
| 3/1 | B4030 (E/B) Ahead Right Left | U | 86.8 | 18.5 | C | | 38 | 498 | 1766 | 1766 | 574 | |
| 4/1 | B430 Ardley Road (N) Left Ahead | O | 87.0 | 21.1 | A | | 41 | 579 | 1902 | 1902 | 666 | |
| 4/2 | B430 Ardley Road (N) Right | O | 6.9 | 0.3 | A | | 41 | 14 | 1713 | 583 | 204 | |
| PRC for Signalled Links (%): | | | 3.5 | Total Delay for Signalled Links (pcuHr): | | | 29.33 | | | | | |
| PRC Over All Links (%): | | | 3.5 | Total Delay Over All Links(pcuHr): | | | 29.43 | Cycle Time (s): 120 | | | | |

Scenario 2: '2013 Base + Gen PM (Sensitivity Test)'

Signal Plan 2: '2013 Base + Gen PM (Sensitivity Test)' Cycle Time (120s)

Flow Group 2: '2013 Base + Gen PM (Sensitivity Test)'

| Link Num | Link Desc | Link Type | Deg Sat (%) | Mean Max Queue (pcu) | Full Phase | Arrow Phase | Total Green (s) | Demand Flow (pcu) | Max Sat Flow (pcu/Hr) | Ave Sat Flow (pcu/Hr) | Capacity (pcu) |
|---|---------------------------------|-----------|--|----------------------|---------------------|-------------|-----------------|-------------------|-----------------------|-----------------------|----------------|
| 1/1 | B4030 (W/B) Left Ahead Right | U | 76.6 | 11.7 | D | | 27 | 325 | 1818 | 1818 | 424 |
| 2/1 | B430 Ardley Road (S) Left Ahead | O | 78.8 | 17.7 | B | | 43 | 538 | 1861 | 1861 | 682 |
| 2/2 | B430 Ardley Road (S) Right | O | 54.4 | 5.5 | B | | 43 | 175 | 1713 | 877 | 322 |
| 3/1 | B4030 (E/B) Ahead Right Left | U | 78.2 | 14.8 | C | | 37 | 434 | 1753 | 1753 | 555 |
| 4/1 | B430 Ardley Road (N) Left Ahead | O | 50.0 | 9.1 | A | | 41 | 331 | 1892 | 1892 | 662 |
| 4/2 | B430 Ardley Road (N) Right | O | 11.9 | 0.3 | A | | 41 | 10 | 1713 | 241 | 84 |
| PRC for Signalled Links (%): 14.2 PRC Over All Links (%): 14.2 | | | Total Delay for Signalled Links (pcuHr): 24.71 Total Delay Over All Links(pcuHr): 24.81 | | Cycle Time (s): 120 | | | | | | |