

notes

- The contractor is responsible for checking dimensions, tolerances and references. Any discrepancy to be verified with the Architect before proceeding with the works.
- Where an item is covered by drawings to different scales the larger scale drawing is to be worked to.

CDM Regulations 2007

ALL current drawings and specifications for the project must be read in conjunction with the Designer's Hazard and Environmental Assessment Record.

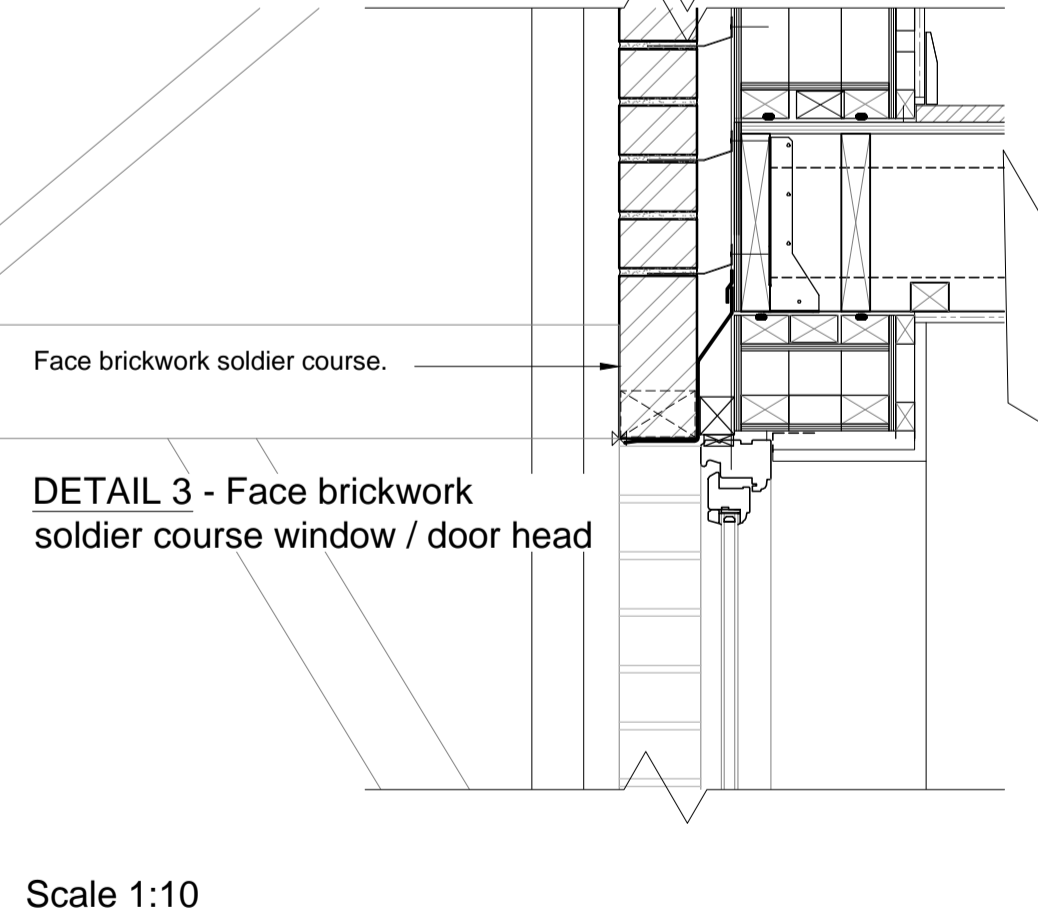
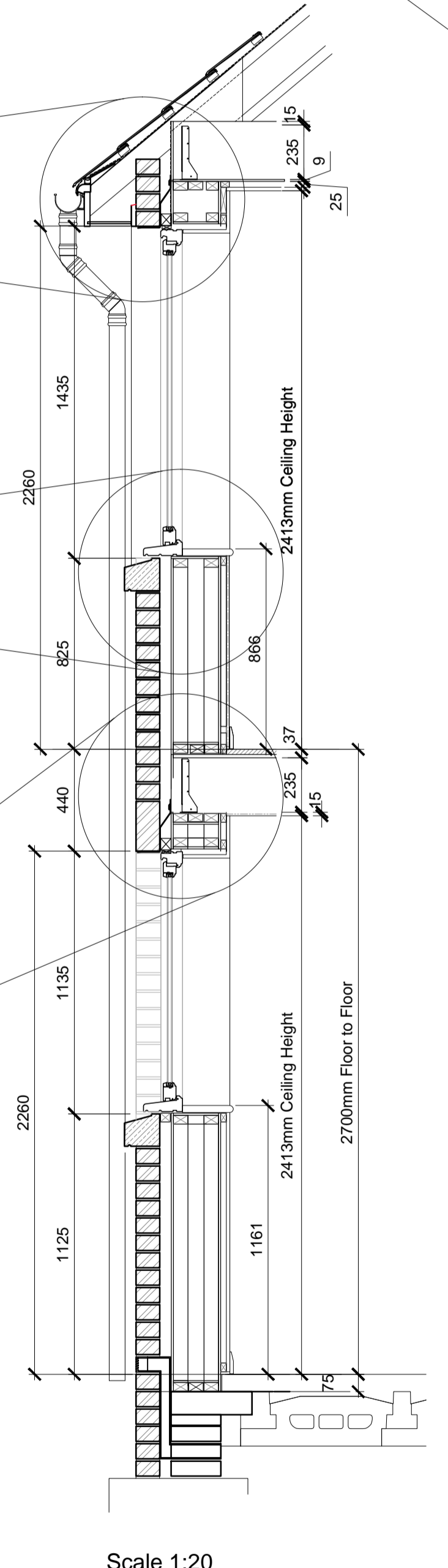
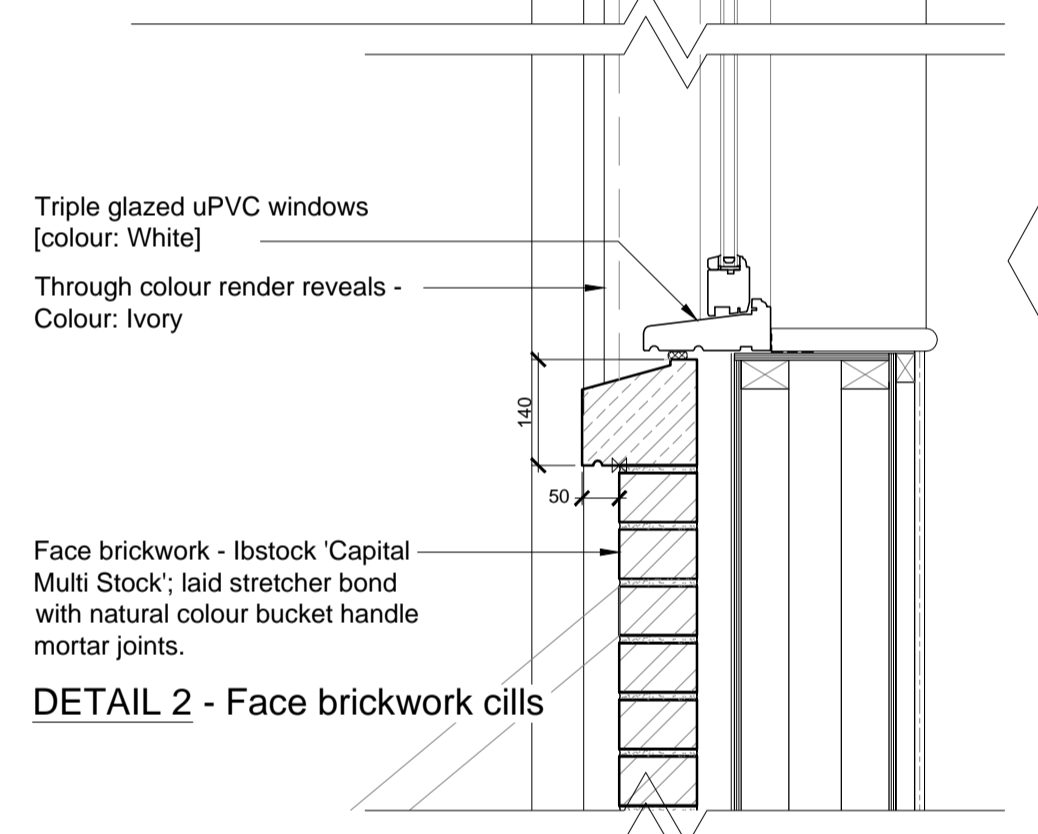
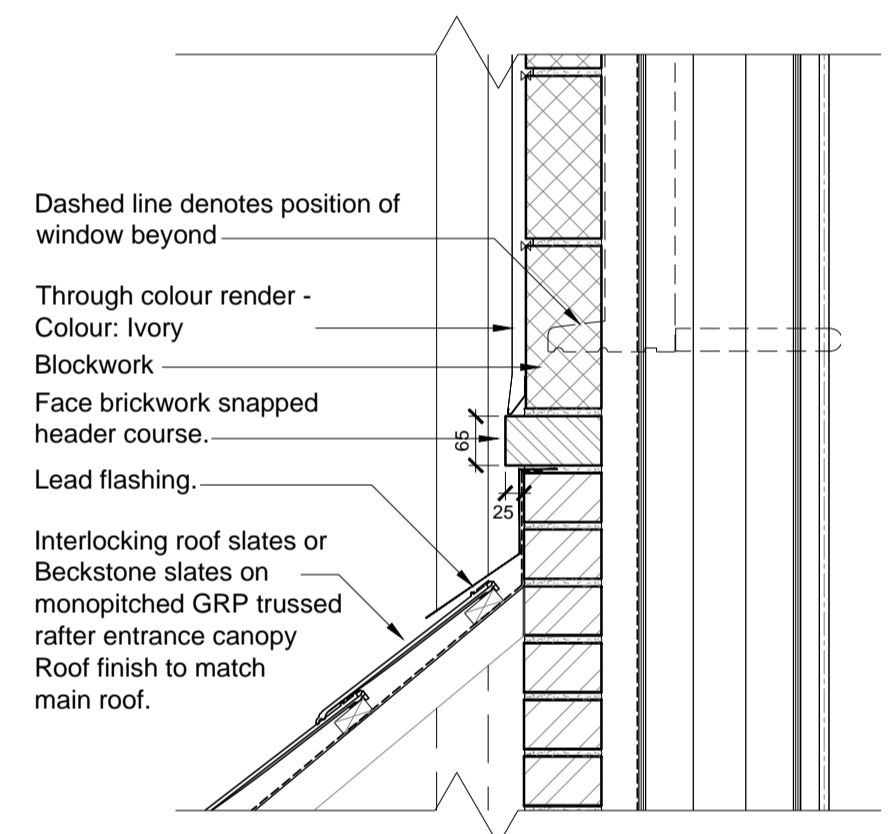
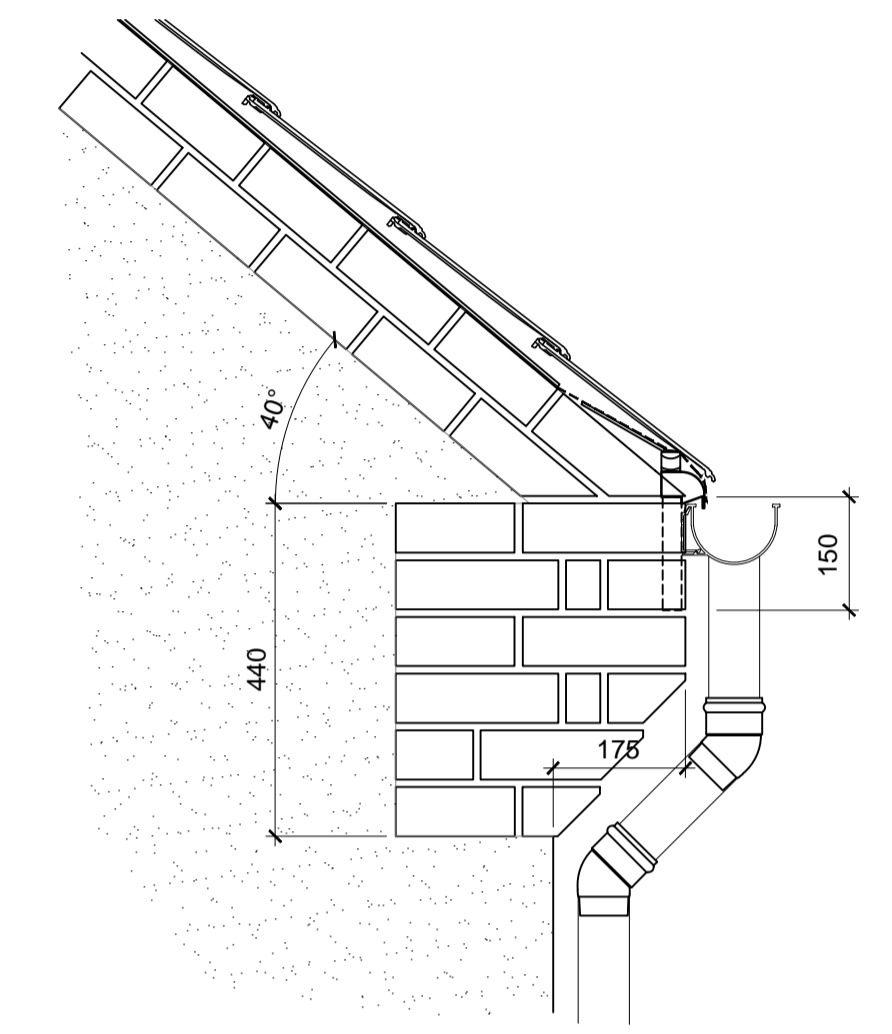
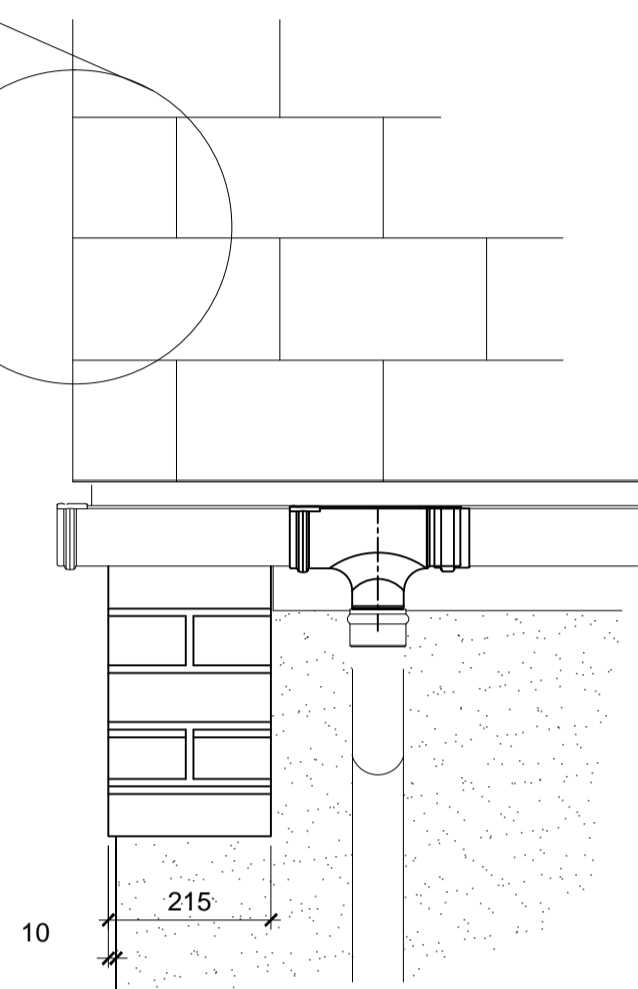
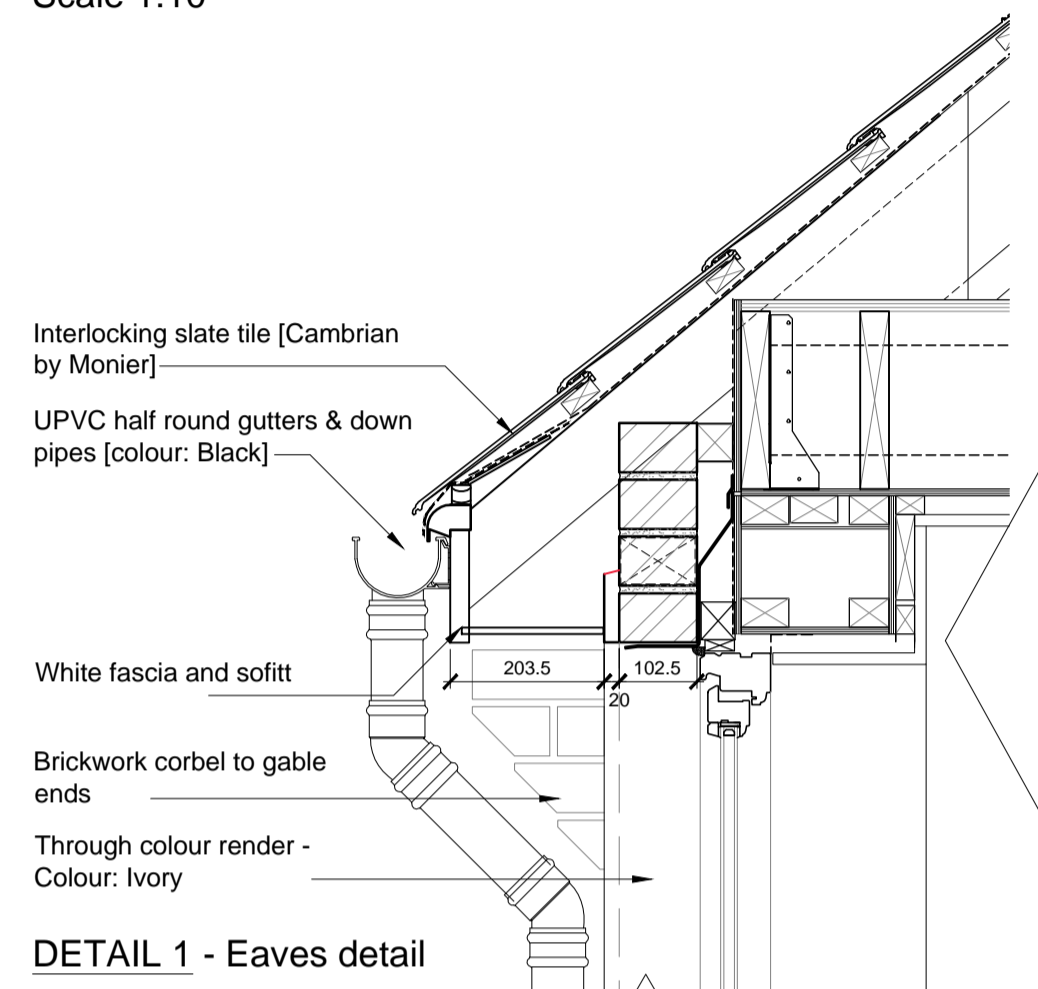

Scale 1:10

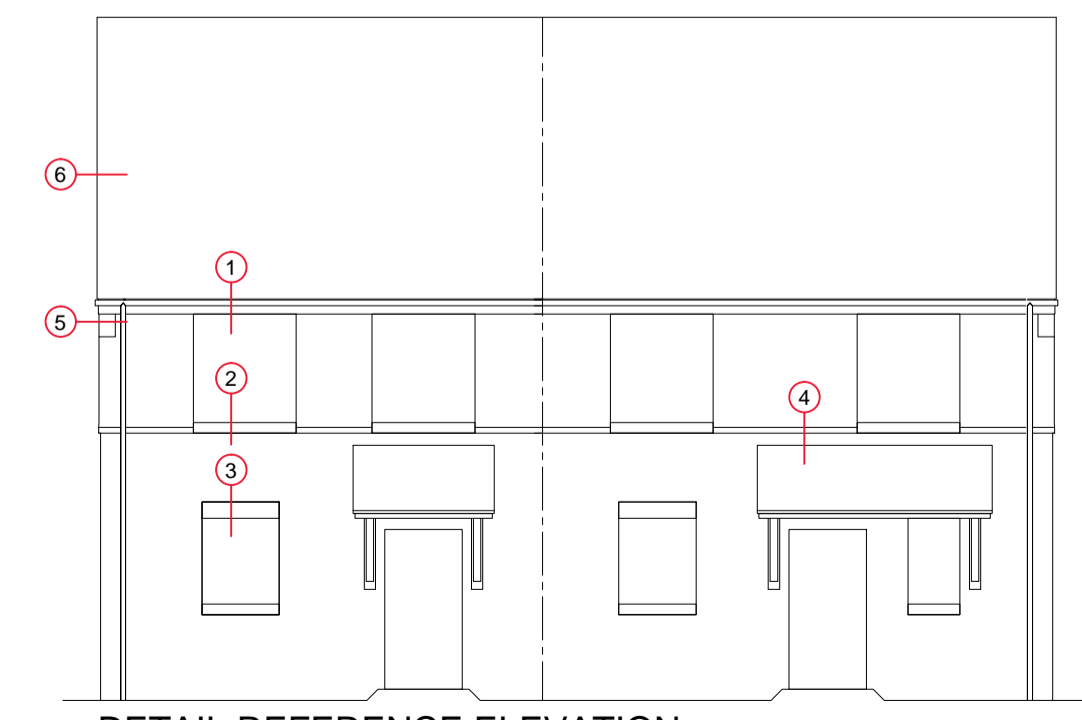

date	rev	revision/author/checker
purpose of issue PLANNING		
project BICESTER ECO TOWN EXEMPLAR SITE		
drawing PROPOSED DETAILS TYPE 1 DWELLINGS [Brickwork / Render]		
drawing no AA2699C/6.1/010	rev -	
drawn JW	checked MB	
scale @ A1 1:20 & 1:10	date JAN 2013	

PRP Architects ©
10 Lindsey Street
Smithfield
London
EC1A 9HP
T +44 (0)20 7653 1200
F +44 (0)20 7653 1201
lon.prp@prparchitects.co.uk

