

DETAIL 6 - Mortar Bedded Verge - Type 5 dwellings - (Brickwork)

Scale 1:10

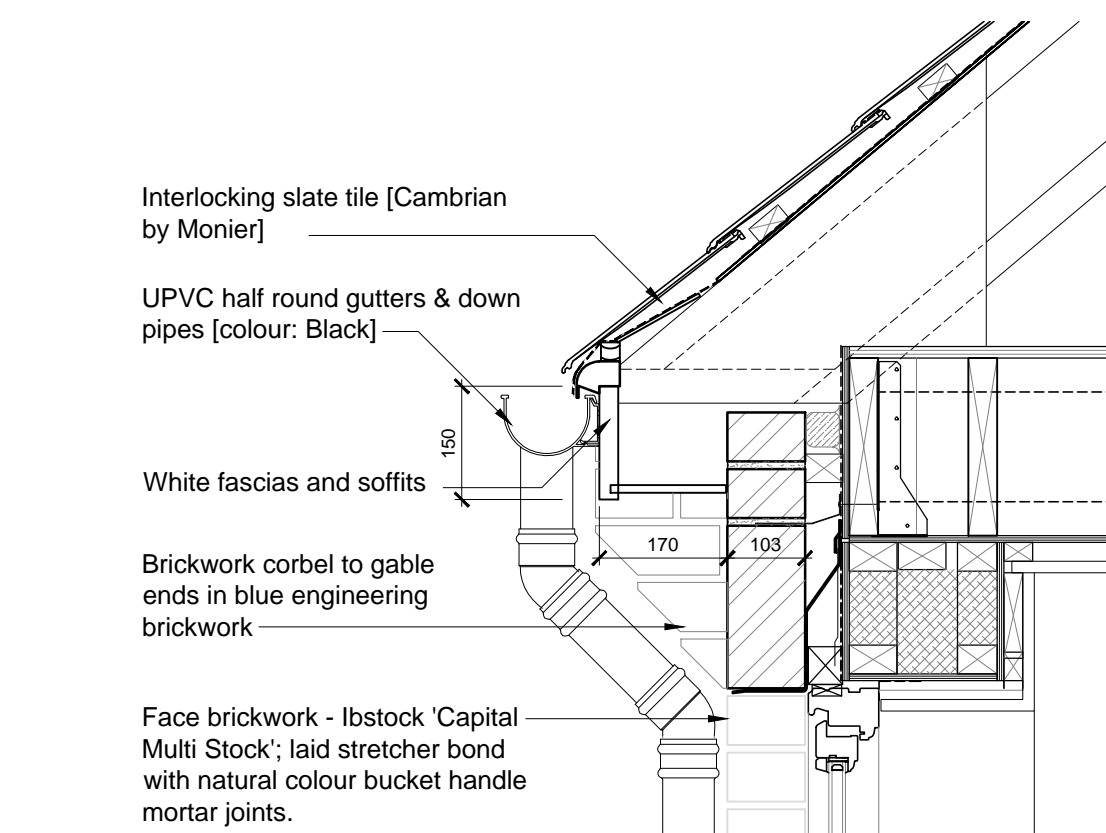

DETAIL 1 - Eaves

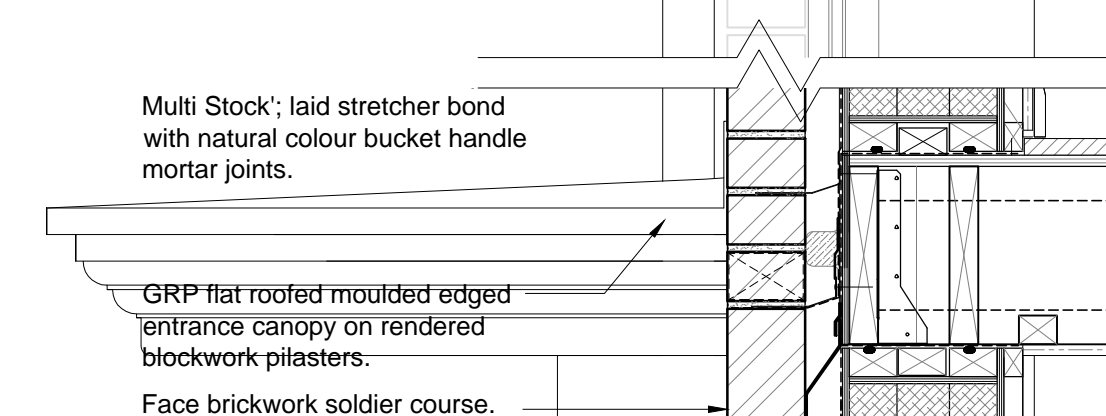

DETAIL 2 - Face Brickwork Window / Door Heads

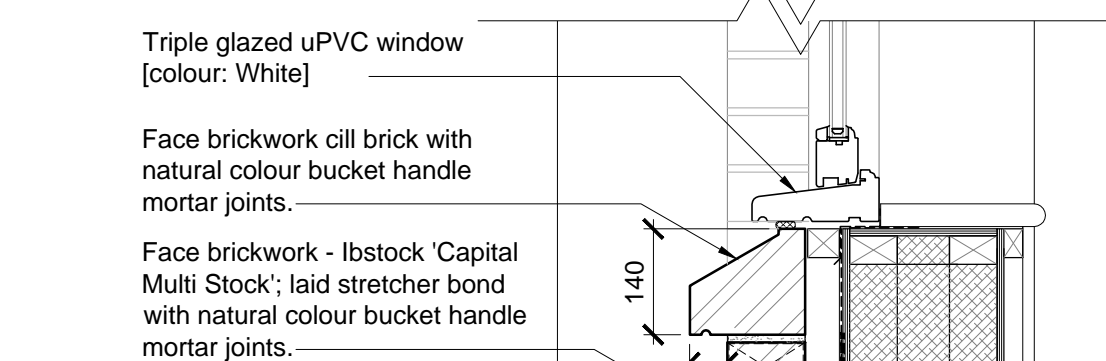

DETAIL 3 - Face brickwork soldier course windowcill

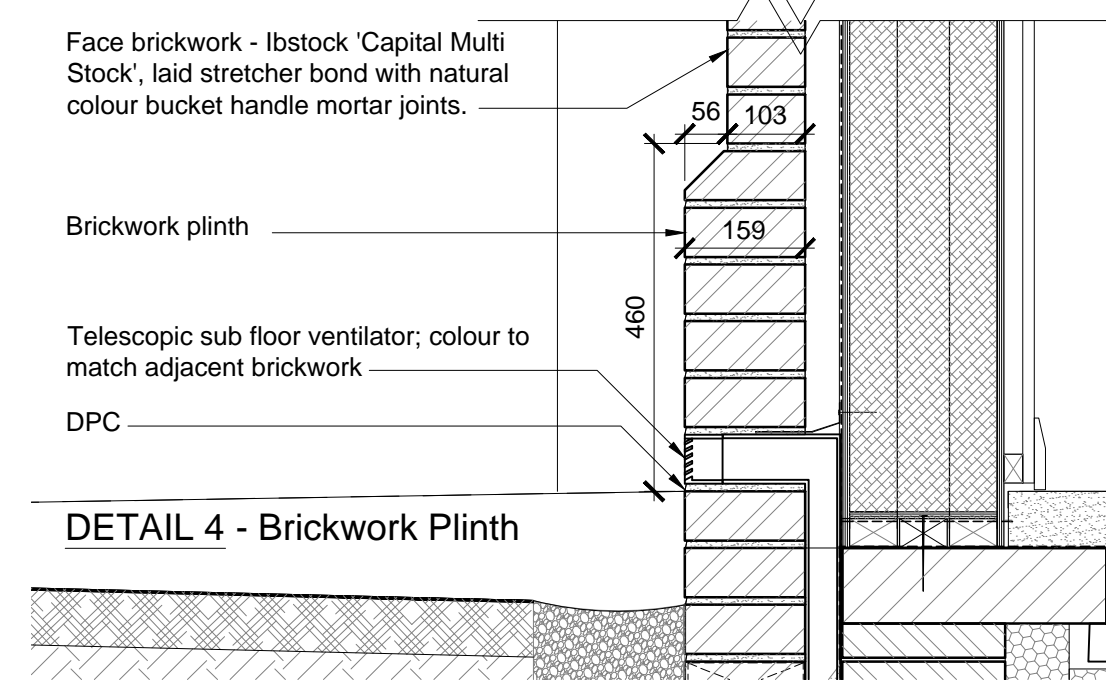

DETAIL 4 - Brickwork Plinth

Scale 1:10

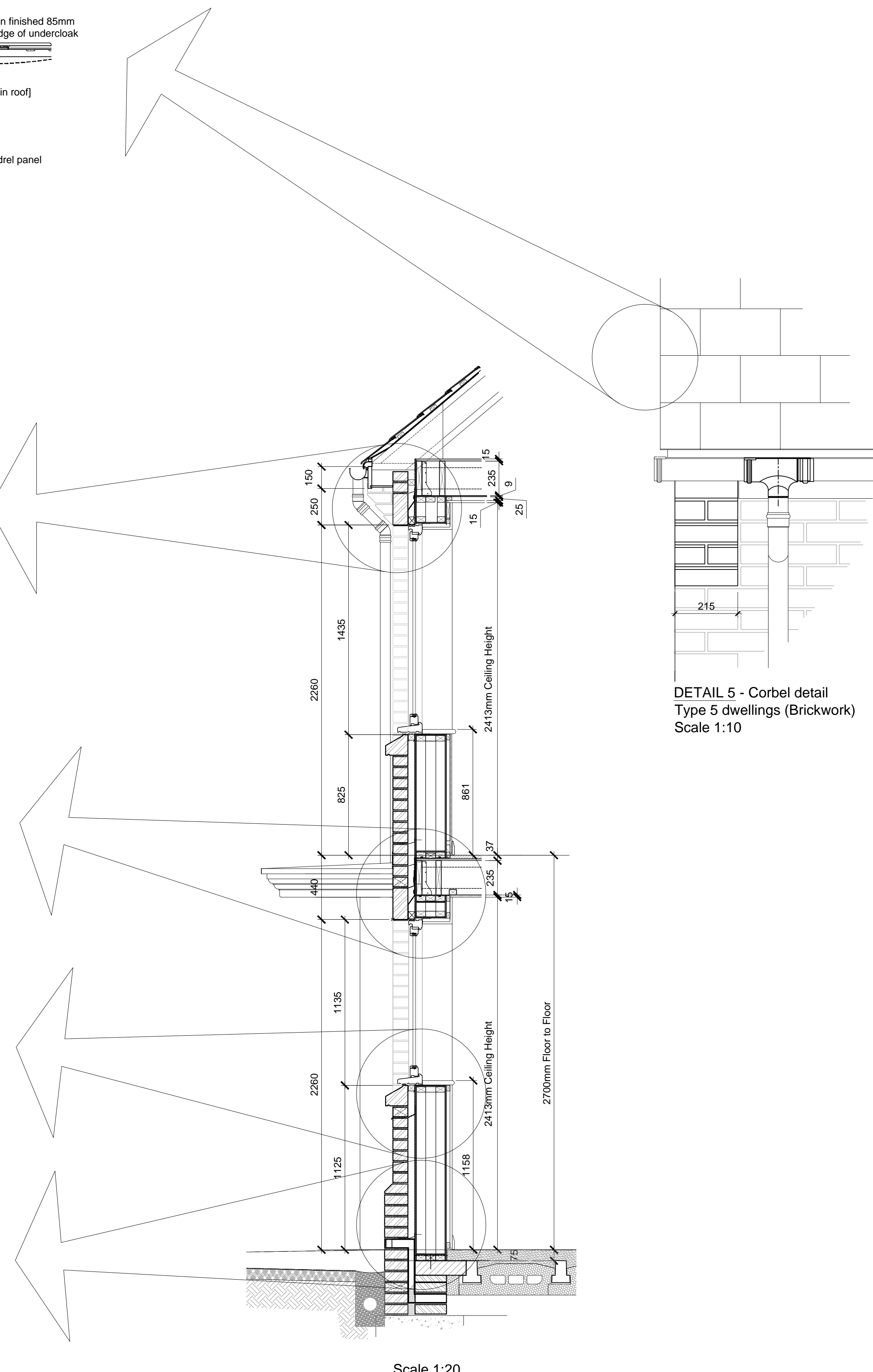

Scale 1:20

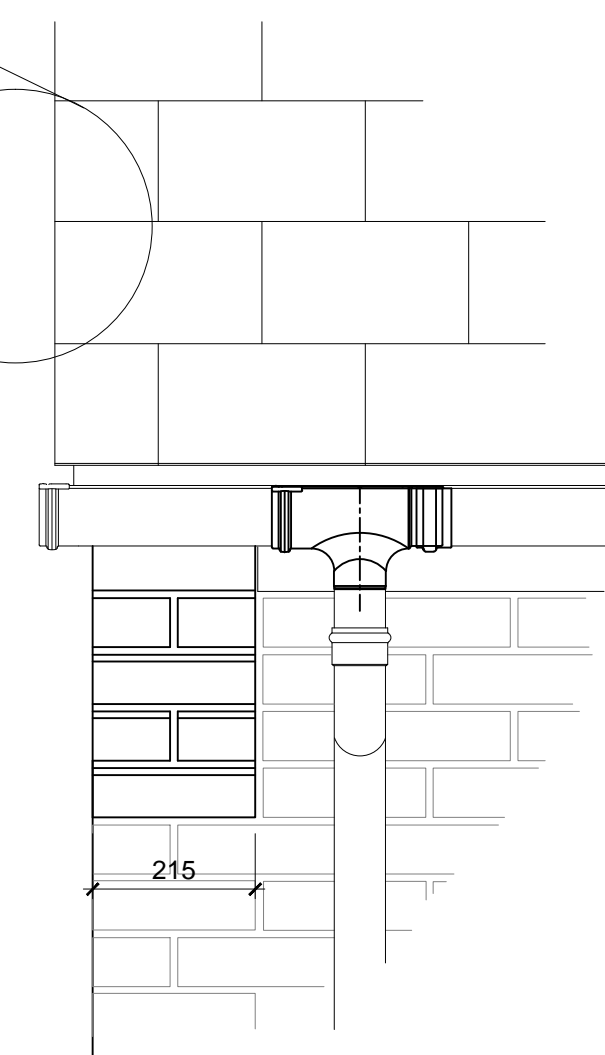

DETAIL 5 - Corbel detail Type 5 dwellings (Brickwork) Scale 1:10

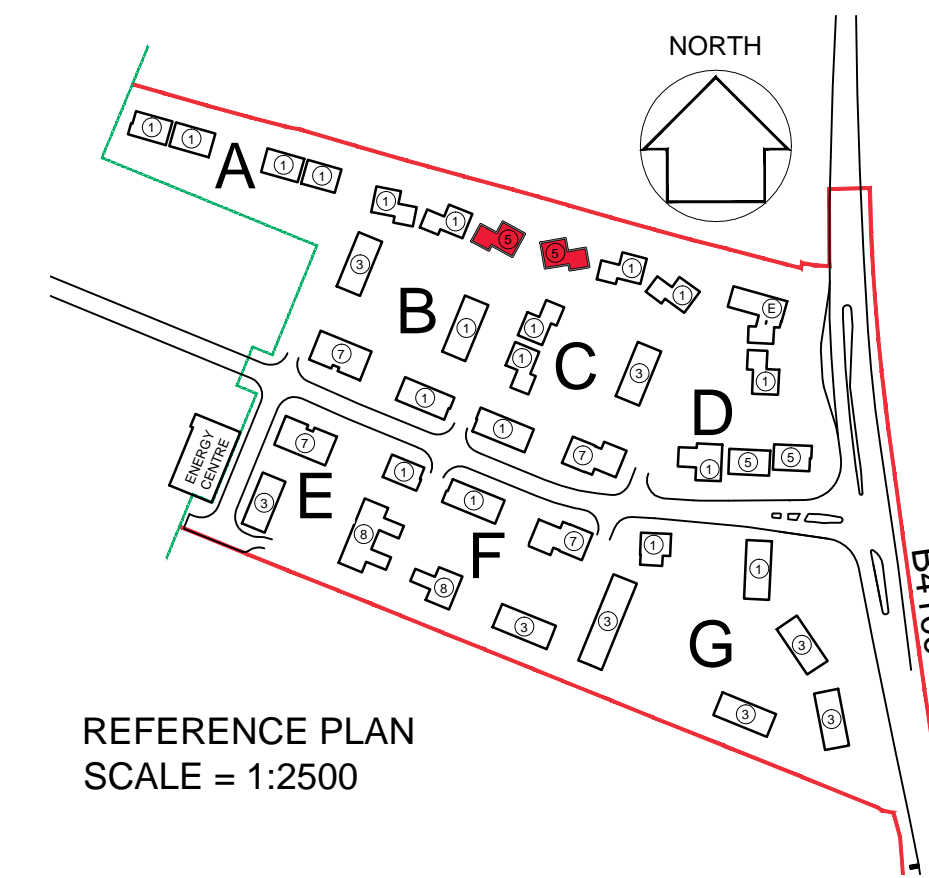

REFERENCE PLAN SCALE = 1:2500

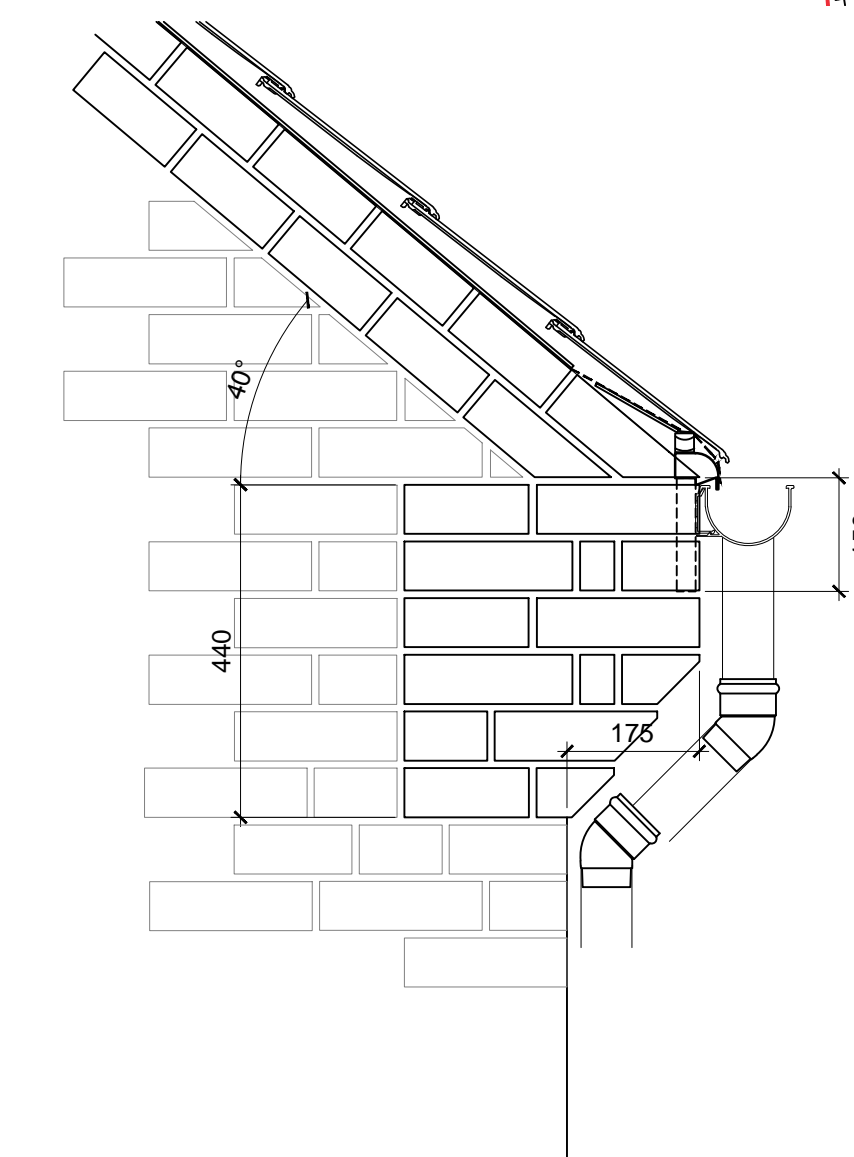

DETAIL REFERENCE ELEVATION TYPE - 5

notes

- The contractor is responsible for checking dimensions, tolerances and references. Any discrepancy to be verified with the Architect before proceeding with the works.
- Where an item is covered by drawings to different scales the larger scale drawing is to be worked to.

CDM Regulations 2007

ALL current drawings and specifications for the project must be read in conjunction with the Designer's Hazard and Environmental Assessment Record.

Notes:

date	rev	revision/author/checker
purpose of issue		
PLANNING		
project		
BICESTER ECO TOWN EXEMPLAR SITE		
drawing		
PROPOSED DETAILS TYPE 5 DWELLINGS [Brickwork]		
drawing no		rev
AA2699C/6.1/014		-
drawn	JW	checked MB
scale @ A1	1:20 & 1:10	date JAN 2013
PRP Architects © 10 Lindsey Street Smithfield London EC1A 9HP T +44 (0)20 7653 1200 F +44 (0)20 7653 1201 lon.prp@prparchitects.co.uk		