



Title: Howes Lane (A4095) / Bucknell Road / A4095 Junction

Technical Note 10 v9

Date: February 2023

1.0 Introduction

- 1.1.1 Jubb has been commissioned by Hallam Land Management Ltd (HLM) to provide highways and transportation advice in relation to a proposal for a residential-led mixed use development on land north-east of the railway line in North West Bicester 'Hawkwell Village'.
- 1.1.2 A planning application (Ref: 21/04275/OUT) was submitted in December 2021 for a residential led mixed use development for up to 3,100 dwellings.
- 1.1.3 The Site forms part of the allocated North West Bicester Eco-Town development. Historical traffic modelling of the allocation has shown a need for the implementation of the A4095 Strategic Link Road (SLR) to bypass the Howes Lane (A4095) / Bucknell Road / A4095 double junction.
- 1.1.4 The Howes Lane (A4095) / Bucknell Road / A4095 consists of a roundabout junction to the north of the railway line and a priority junction to the south of the railway line and currently operates over capacity and offers no meaningful active travel crossing facilities.
- 1.1.5 Oxfordshire County Council (OCC) received funding from Homes England and the Oxfordshire Housing and Growth Deal to implement infrastructure in order to enable proposed development to come forward. The funding allocated to the SLR has enabled the completion of the rail underbridge. Unfortunately, due to time limits on spending of the allocated fund, the remaining monies have been reallocated to other strategic highway schemes in Oxfordshire. Hallam are currently in discussion with OCC and Cherwell District Council (CDC) to investigate other potential funding mechanisms for the SLR.
- 1.1.6 The SLR is a large strategic piece of highway infrastructure and will cost a considerable sum of money. Hawkwell Village will need to deliver and release a significant quantum of dwellings in order to be able to financially contribute its share of the s106 requirements to fund the road.
- 1.1.7 Therefore, this Technical Note (TN) undertakes a review of the operation of the existing Howes Lane (A4095) / Bucknell Road / A4095 junctions and promotes an interim signalisation scheme to mitigate the effects of the early phases of the development, before the SLR is delivered. The scheme offers improved active travel crossing facilities. When the SLR has been delivered, traffic levels travelling through the Howes Lane (A4095) / Bucknell Road / A4095 junctions decreases and there will be an opportunity to deliver a 'final solution' scheme which concentrates on active travel movements through the junction.
- 1.1.8 Following the submission of Versions 6 and 8 of this TN to OCC and the return of initial comments from the Highway Officer, this version provides a redesign of the junction and subsequent remodelling to address the matters raised by OCC i.e. pedestrian route across Bucknell Road, proximity of junction to Network Rail land and existing properties, visibility to signal heads and future location of signs/street lights.
- 1.1.9 The Firethorn planning application (Ref: 21/01630/OUT) for 530 residential dwellings, with a recommendation by the planning officer for permission to be granted (subject to the expiry of the consultation period, conditions and subject to a s106 agreement), was considered by Councillors at the CDC Planning Committee held on 12th January 2023; the application was deferred due to the need of Councillors to consider the submission of late comments.

- 1.1.10 Following extensive discussions between the applicant’s transport consultants and OCC Highways regarding the effect of the development on the Howes Lane (A4095) / Bucknell Road / A4095 junctions, OCC have concluded **that a 50% increase in delay at the junction is not a ‘severe’ impact and that in “the context of an increasingly urban setting, drivers will become accustomed to congestion on all routes into and around Bicester by 2026”**. The accepted increase will increase delay for vehicles travelling through the junction from 6 minutes to 9 minutes.
- 1.1.11 It is therefore clear from this decision that OCC considered that the additional traffic associated with the 530 dwellings would not impact on the safety of pedestrian and cycle movements through the junction.
- 1.1.12 OCC have also given weight to the delivery of the SLR, stating “the most challenging element of the road scheme, the bridge under the railway, has already been delivered” and that “there are current development proposals on the land required for the scheme, which means the land can potentially be safeguarded”. **OCC Highways conclude that the impact of the development, given the future delivery of the SLR will be temporary and is not considered to be severe.**
- 1.1.13 OCC removed their Highways Objection and thus a precedent has been set, regardless of the result of the Planning Committee. This decision would enable a minimum of 530 dwellings in North West Bicester to be occupied with no mitigation at the Howes Lane (A4095)/Bucknell Road/A4095 junction.
- 1.1.14 It is understood that since the Firethorn application was deferred at committee the applicants have lodged a planning appeal.

2.0 Technical Background

- 2.1.1 OCC have specified that the recently revalidated Bicester Transport Model (BTM) is the preferred modelling tool to assess future development and mitigation options in Bicester. It is OCC’s model and the development trip generation used in this assessment is the model’s trip generation i.e. not the reduced ‘Vision’ trip generation which has been discussed with OCC. Therefore, it is understood that the traffic flow movements produced by the BTM and used for the purposes of this assessment, are in accordance with the requirements of OCC. The model’s trip generation is considered to offer an assessment that is a worst-case scenario and in reality, the trip generation of the development will be less.
- 2.1.2 Tetra Tech, custodians of the Bicester Transport Model (BTM), were commissioned by HLM to undertake SATURN model runs of the following scenarios:
- 2026 Reference Case – Base + Committed Traffic;
 - 2026 Hawkwell with Development 1a – 675 dwellings; and
 - 2026 Hawkwell with Development 2a – 1250 dwellings.
- 2.1.3 Tetra Tech provided turning movements for each scenario attached at **Appendix A**. From these turning movements, Traffic Flow Diagrams, attached at **Appendix B**, have been produced.
- 2.1.4 It should be noted that this version of the TN uses the revised turning movements provided by Tetra Tech (26th January 2023). It is understood that an issue was identified requiring the demand model to be altered which led to the 2026 and 2031 ‘with development’ scenarios to be rerun.

3.0 Review of the Design of the Existing Junctions

Pedestrian Infrastructure and Movements

- 3.1.1 The junction currently offers no controlled crossing facilities for pedestrians. The following facilities are currently available at the southern priority junction to enable pedestrian movements:
- Dropped kerb crossing on the A4095(W) arm crossing 3 lanes of traffic;

- Dropped kerb crossing on Bucknell Road in the vicinity immediately south of the railway bridge with limited visibility to vehicles turning left from the A4095(W) arm and requiring pedestrians to look behind; and
- No facilities on the Bucknell Road(S) arm.

3.1.2 **Figure 3.1** records the width of the existing footways in the vicinity of the southern junction.

3.1.3 The DfT report ‘Inclusive Mobility’ sets out a standard width of 2m for footways with a minimum width of 1.5m where there are physical restraints; it also states that the width can be reduced to an absolute minimum of 1m but that this can only occur over a maximum distance of 6m.

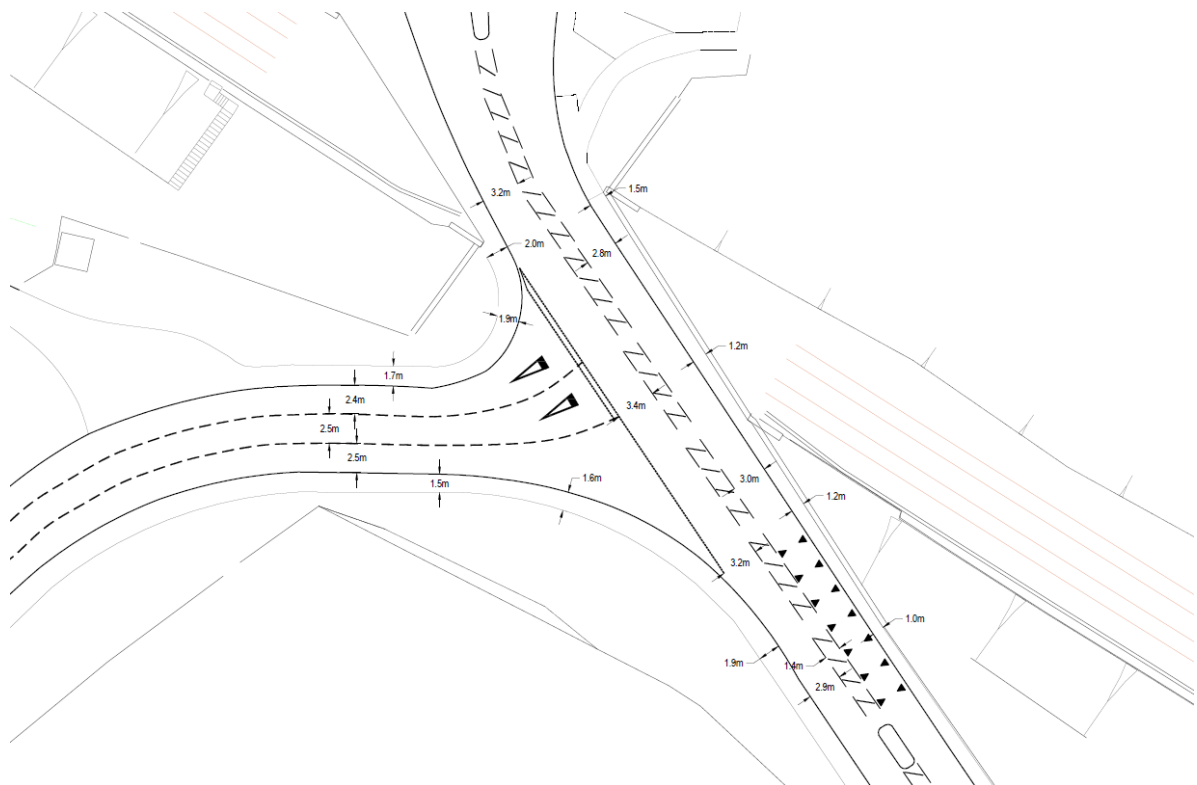

Figure 3.1 – Existing geometry at the Southern Priority Junction

- 3.1.4 It can be seen that the eastern footway is narrow and does not meet the minimum width and the remaining footways are of varying widths between 1.0 and 1.5m.
- 3.1.5 The southern footway varies in width between 1.5 and 1.9m and the northern footway varies in width between 1.7 – 2.0m.
- 3.1.6 A classified count of all movements through the two junctions was undertaken on Tuesday 8th February 2022 during the AM and PM peak periods.
- 3.1.7 The recorded pedestrian movements for the AM and PM peak hours are shown in **Figure 3.2**.

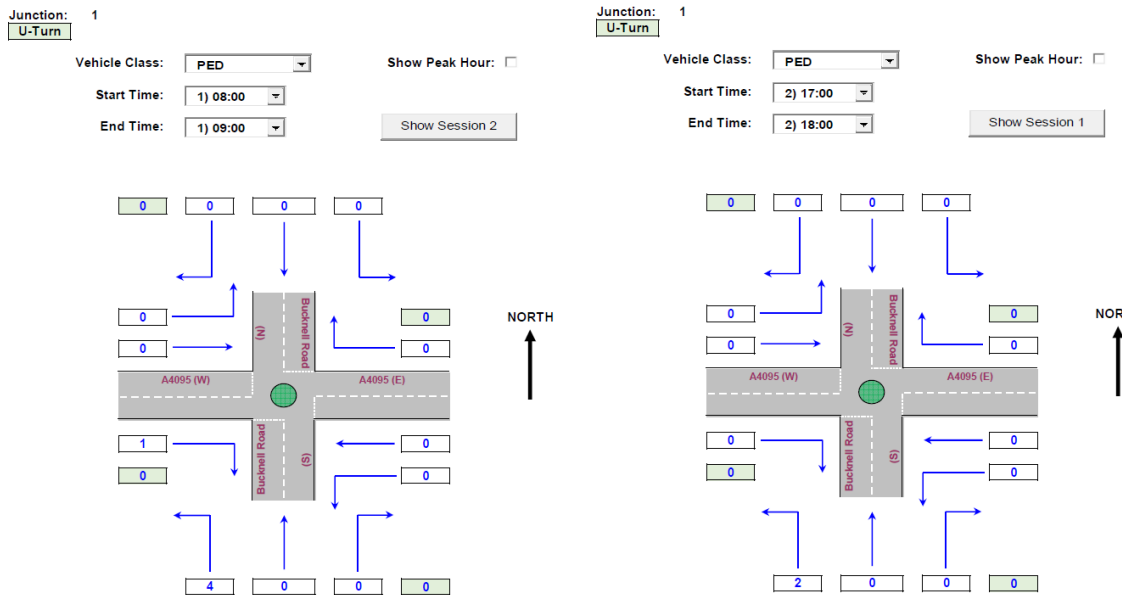

Figure 3.2 – 2022 Survey – Peak Hour Pedestrian Movements

3.1.8 The survey indicates that there were 5 and 2 pedestrian movements through the junction during the AM and PM peak hours respectively which consisted of:

- All AM movements were between the A4095(W) and the Bucknell Road (S) arms; no movements were recorded across Bucknell Road i.e. in the vicinity of the railway bridge; and
- Both PM movements were between the A4095(W) and the Bucknell Road(S) arms; no movements were recorded across Bucknell Road.

3.1.9 The results indicate that there is only a limited number of pedestrian movements through the junction during the peak hours and highlights that movements across Bucknell Road (immediately south of the railway bridge) will be very low. It is recognised by OCC that the main desire line for pedestrians from the Hawkwell Village development will be towards the town centre along the existing active travel route adjacent to the railway line and therefore, additional pedestrian movements across the junction arising from the proposed development will be limited.

Cyclist Movements

3.1.10 Cycle movements through the junction take place within the carriageway with cyclists/vehicles giving way in the normal manner at priority and roundabout junctions.

3.1.11 The recorded cyclist movements for the AM and PM peak hours are shown in **Figure 3.3**.

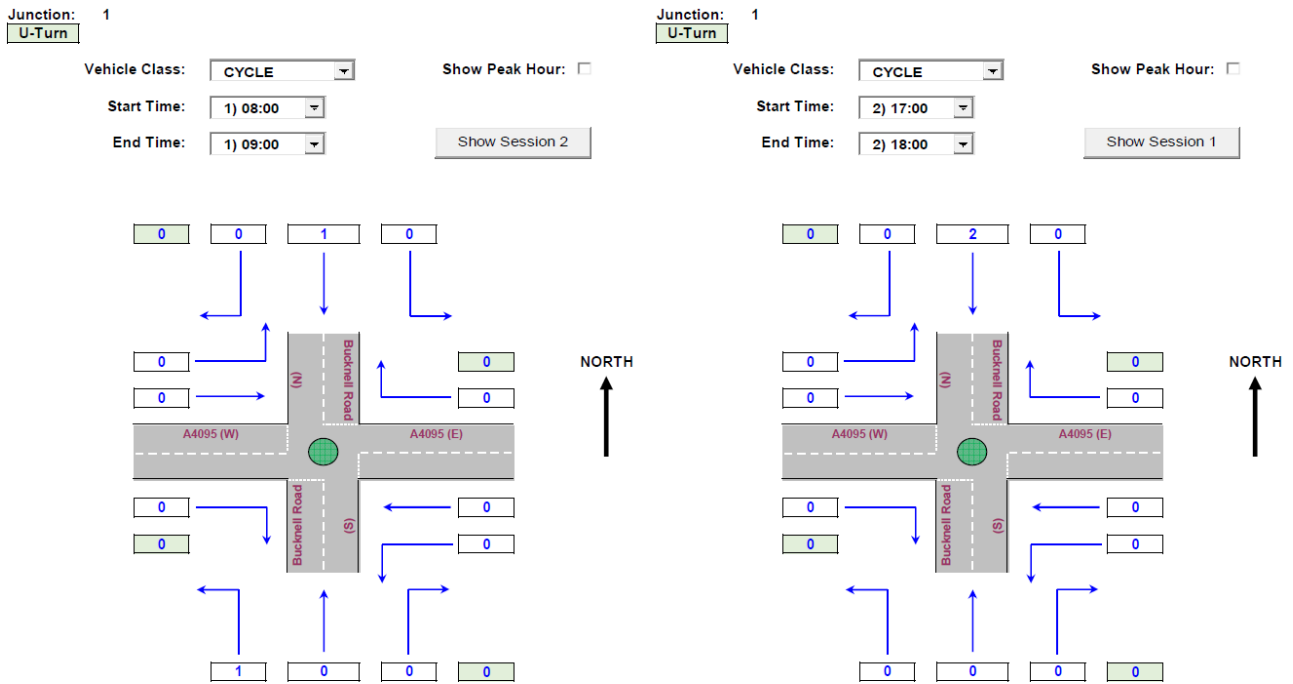

Figure 3.3 – 2022 Survey – Peak Hour Pedestrian Movements

3.1.12 The survey indicates that there were 2 cyclist movements through the junction during both the AM and PM peak hours and consisted of:

- 1 movement between the Bucknell Road(S) and the A4095(W) arms and 1 movement between the Bucknell Road (N) and the Bucknell Road (S) arms in the AM peak hour; and
- Both movements were between the Bucknell Road (N) and Bucknell Road(S) arms in the PM peak hour.

3.1.13 The results indicate that there is only a limited number of cyclist movements through the junction during the peak hours. It is recognised by OCC that the main desire line for cyclists from the Hawkwell Village development will be towards the town centre along the existing active travel route adjacent to the railway line and therefore, additional cycle movements through the junction arising from the proposed development will be limited.

Articulated Vehicle Movements

3.1.14 Tracking of articulated vehicles through the existing southern junction has been undertaken and is shown at **Appendix C** and reproduced in **Figure 3.4**.



Figure 3.4 – Existing Southern Junction Vehicle Tracking

- 3.1.15 The tracking clearly shows that a left-turning articulated vehicle approaching the junction on the A4095(W) arm requires the use of both approach lanes i.e. blocks right-turners, and is unable to carry out its manoeuvre without southbound vehicles on Bucknell Road (underneath the bridge) stopping as the articulated vehicle passes over the centre line of the carriageway. This articulated vehicle manoeuvre and the requirement for other vehicles to stop is shown clearly in Figure 2.4 of the Velocity Transport Planning (VTP) Technical Note 08 which is reproduced below in **Figure 3.5**.
- 3.1.16 Tracking of an articulated vehicle turning right into A4095(W) also indicates the requirement for the vehicle to use the southern approach lane on the A4095(W) arm i.e. vehicles turning right from the A4095(W) arm would either need to clear their move before the articulated vehicle movement or to wait a sufficient distance from the junction to enable the articulated vehicle to undertake its manoeuvre.
- 3.1.17 The tracking indicates that the east/west movement of articulated vehicles through the southern junction is currently unsuitable and gives rise to highway safety concerns; the movement of articulated vehicles relies on the ability of other vehicles to give-way in unexpected places whilst progressing through the junction i.e. where their movement has right of way / is free flowing and they are not expected to have to stop.



Figure 3.5 – Observed Articulated Vehicle Movement through Southern Junction

3.1.18 The recorded articulated vehicle movements for the AM and PM peak hours are shown in Figure 3.6.

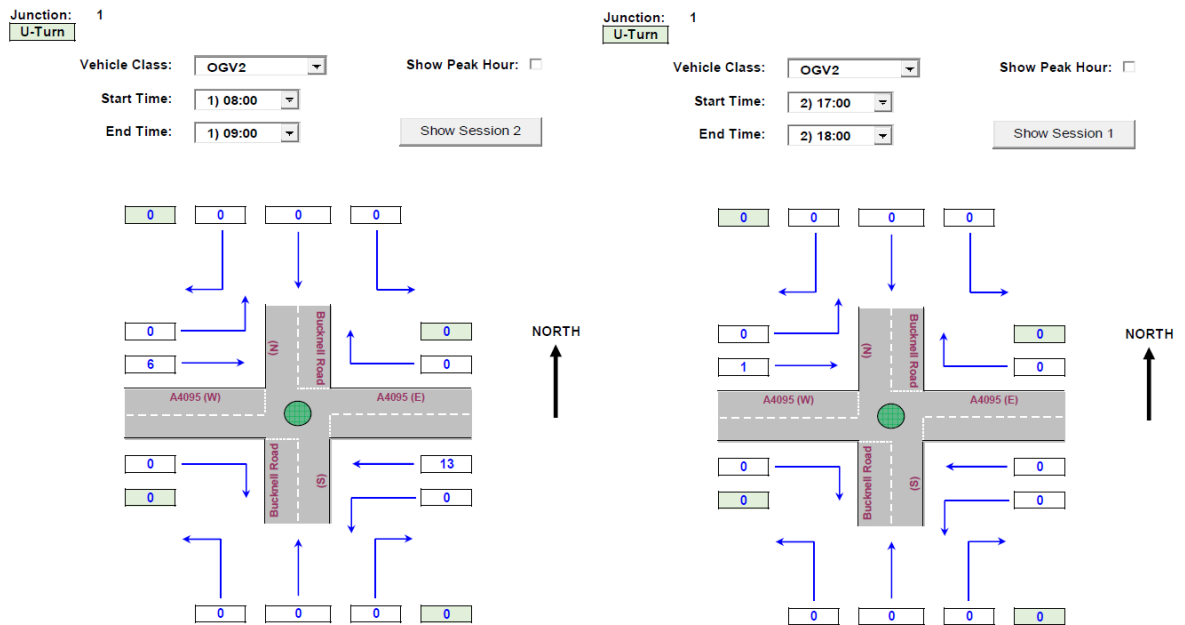

Figure 3.6 – 2022 Survey – Peak Hour Articulated Vehicle Movements

3.1.19 It can be seen that articulated vehicle movements only occur between the A4095 eastern and western arms.

3.1.20 In the AM peak hour there are 6 articulated vehicle movements from A4095(W) to A4095(E) and 13 articulated vehicle movements from A4095(E) to A4095(W). In the PM peak hour there is a single articulated vehicle movement from A4095(W) to A4095(E).

Junction Capacity Operation

3.1.21 Using the traffic flows provided by the BTM, the '2026 Reference Case' operation of the existing junctions has been undertaken using the JUNCTIONS 10 software. Due to the proximity of the two junctions and their operation being dependent on each other, the modelling has been undertaken using 'linked lane simulation'. A summary of the results is shown in **Table 3.1** with the output report attached at **Appendix D**.

3.1.22 The roundabout is modelled as Junction 1 and the priority junction as Junction 2.

Arm	AM			PM		
	Queue (PCU)	Delay (s)	Max LOS / RFC	Queue (PCU)	Delay (s)	Max LOS / RFC
J1 – Bucknell Road (North)	1.1	14.74	B	0.7	11.40	B
J1 – A4095 (East)	184.6	622.83	F	193.5	638.13	F
J1 – Bucknell Road (South)	1.2	4.68	A	1.2	4.50	A
J2 – Bucknell Road (South)	0.2	0.68	A	0.1	0.47	A
J2 – A4095 Howes Lane (West)	53.4	291.99	F	232.6	972.07	F
J2 – Bucknell Road (North)	3.1	16.51	C	3.0	14.67	B

Table 3.1 – Summary of Junction Results for Existing Junctions – Base + Committed Development

3.1.23 The 'linked lane simulation' results indicate that the existing junctions will operate over capacity in 2026 with committed traffic. The committed development traffic is generated by the following committed development that is included in the 2026 BTM: 8,085 dwellings, 15,642sqm retail use, 308,335sqm employment use and 1,899 jobs of other employment use.

3.1.24 Queues on the A4095 East arm of Junction 1 (roundabout) are predicted to be 185 pcus in the AM peak hour and 194 pcus in the PM peak hour. In the AM peak hour queues will extend to just before the A4095 / B4100 (Banbury Road) roundabout and in the PM peak hour the queue will extend across the A4095 / B4100 (Banbury Road) roundabout.

3.1.25 Queues on the A4095 West arm of Junction 2 (priority) are predicted to be 54 pcus in the AM peak hour and 233 pcus in the PM peak hour. These queues extend across the Avonbury Business Park and Thames Valley Police junctions in the AM peak hour and to just before the A4095/ B4030 / Middleton Stoney Road roundabout in the PM peak hour.

3.1.26 **Figure 3.7** shows a visual representation of the predicted traffic queues for the '2026 Reference Case' scenario.



Figure 3.7 – 2026 Reference Case – Predicted Vehicle Queue Lengths

- 3.1.27 It should be noted that the BTM predicts 2,105 AM vehicle movements and 2,342 PM vehicle movements through the junctions in the 2026 Reference Case Scenario. The 2022 surveys recorded 1,904 and 1,636 vehicle movements in the AM and PM peak hours respectively. The growth between the recorded 2022 and the BTM ‘2026 Reference Case’ is 11% in the AM peak hour and 43% in the PM peak hour. The 11% increase in the AM peak hour over a four year period is considered to be an acceptable increase but the increase of 43% in the PM peak hour is excessively high. This anomaly between the BTM model results and surveyed traffic flows in the PM peak hour is also highlighted in VTP’s TN 008 where a 61% difference was identified.
- 3.1.28 OCC have commented that the queues lengths reported by the ‘2026 Reference Case’ modelling appear to be longer than modelling undertaken for other developments. As requested, the modelling has been undertaken using the BTM traffic flows and as the model provides future year traffic flows only, it is not possible to undertake a validation exercise. In addition, the modelling undertaken for the Firethorn development has assessed and validated only the southern priority junction; due to the proximity of the two junctions and their obvious interaction and subsequent blocking of movements, it is considered that the presented modelling is a more accurate assessment of the junctions’ performance. Finally, as shown in this report, the mitigation scheme does not only mitigate the development traffic (i.e. the performance of the junction remains the same as the ‘2026 Reference Case’ scenario) but it mitigate all traffic (i.e. background + committed) and therefore, the performance relative to the existing design is not of relevance; it is sufficient to understand that the existing junctions are operating over capacity and the mitigation scheme provides a comprehensive solution.

4.0 Proposed Interim Mitigation Scheme

- 4.1.1 In order to improve safety, active travel facilities and reduce queues and delay, it is proposed to signalise the two junctions with the added benefit of providing controlled pedestrian / cycle crossing points. The preliminary design drawing is attached at **Appendix E** and reproduced below in **Figure 4.1**.

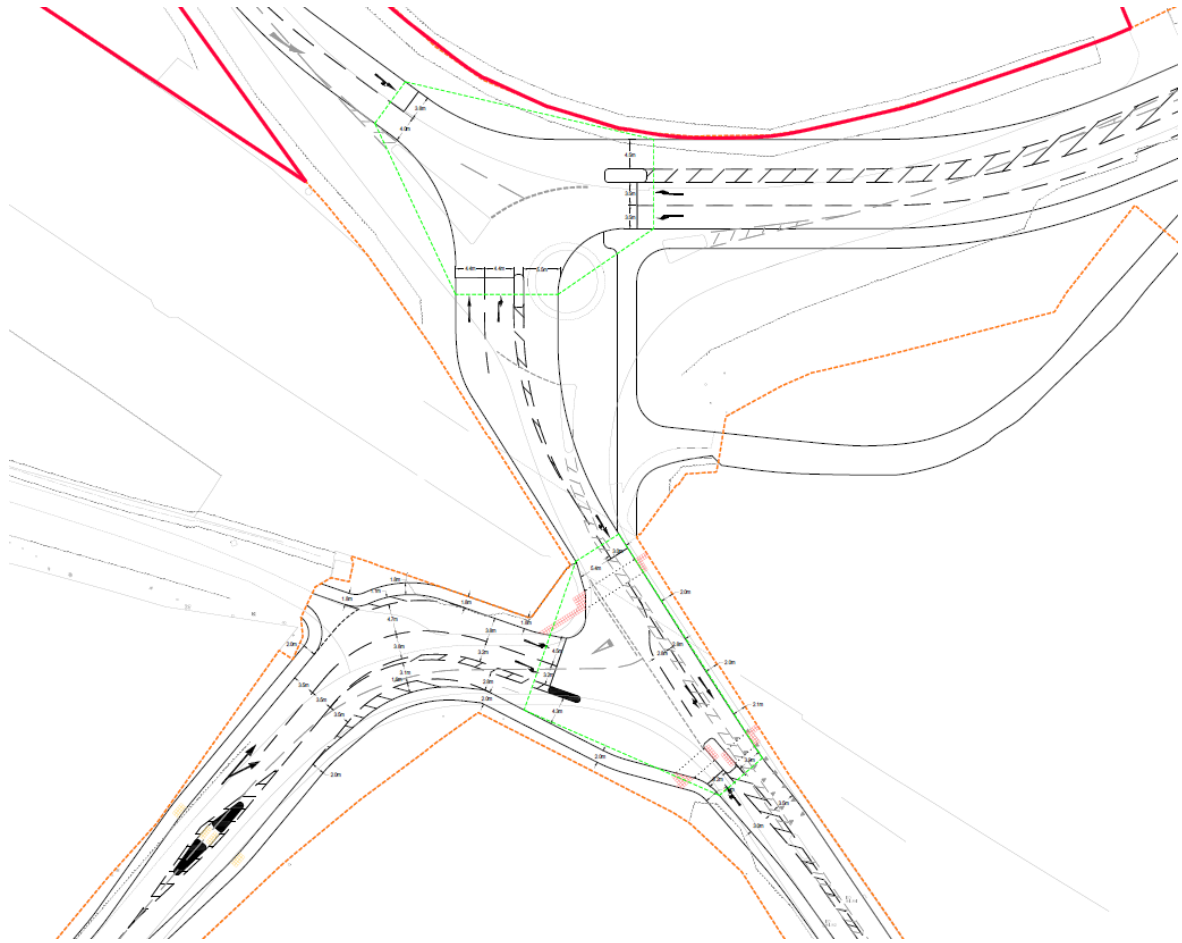

Figure 4.1 – Proposed Junction Layout

Pedestrian Improvements

- 4.1.2 The widths of the footways on the southern junction have been rationalised and improved. The footway alongside the eastern edge of Bucknell Road has been widened from 1.0-1.5m to a constant 2.0m. The footway from Bucknell Road(S) to A4095(W) has been widened from 1.5-1.9m to a constant 2.0m. The footway from A4095(W) to Bucknell Road (N) has been rationalised from between 1.7-1.9m to 1.8m; there is the opportunity to widen this footway to 2.0m but the widening would require a reduction in width between the southern footway and the Goldsmith Close fence; it is considered that as this is an interim scheme and the surveyed level of pedestrian movements is minimal /will remain minimal that a 1.8m footway is suitable.
- 4.1.3 In the proximity of the existing dropped kerb uncontrolled pedestrian crossing point on Bucknell Road (immediately south of the railway bridge) a controlled pedestrian crossing has been introduced providing a safer environment for east/west pedestrian movements.
- 4.1.4 An additional controlled pedestrian crossing has been introduced on the Bucknell Road(S) arm where currently there are no pedestrian crossing facilities and provides a safer environment for pedestrians.
- 4.1.5 An uncontrolled pedestrian crossing facility with a mid-crossing refuge has been introduced on the A4095(W) arm. The refuge enables pedestrians to cross the road in two stages meaning that only one lane of traffic needs to be crossed at a time and significantly improving the safety of pedestrians who currently have to cross three lanes of traffic in a single movement.

Cycling Improvements

- 4.1.6 Whilst the interim scheme does not provide particular cycle infrastructure, the introduction of signals will remove the number of conflicts with vehicles travelling through the junction as cyclists will be within a stream of traffic which will have a priority to undertake its manoeuvre.

Articulated Vehicle Improvements

- 4.1.7 Whilst articulated vehicle movements were only observed travelling from/to the A4095(W) and A4095(E) the junction has been designed to enable the safe movement of articulated vehicles from and to all arms.
- 4.1.8 The vehicle tracking attached at **Appendix F** shows significant improvements to the left-out and right-in articulated vehicle movements from/to the A4095(W) arm. Both of these articulated vehicle movements can now be undertaken without the use of the A4095(W) right-turn lane and without the use of the eastern carriageway of Bucknell Road under and immediately south of the railway bridge. All articulated vehicle movements can now be undertaken alongside all other vehicle movements through the junction and significantly improve highway safety and reduce delays through the junction.

Detailed Design Matters

- 4.1.9 The visibility to signal heads is provided at **Appendix G**. This indicates that all primary signal heads on the main approach arms of the junction have 90m of visibility with 43m of visibility achievable for the signal heads within the central area of the junction.
- 4.1.10 The location of existing signage and where required, its repositioning is shown on the drawing attached at **Appendix H**.
- 4.1.11 The location of existing street lighting and where required its repositioning, is shown on the drawing attached at **Appendix H**.
- 4.1.12 The positioning of the signal head on the eastern side of Bucknell Road (south of the railway bridge) will not affect the safe movement of pedestrians. The existing footway is 1.2m wide and supports a street light (with a shaft diameter of a minimum 140mm). The proposal will widen the footway to 2.0m; signal head poles have a diameter of 114mm). Therefore, the signal head pole diameter is less than the street light and an additional 800mm of footway is being provided. Signal heads are required to have a minimum height clearance of 2.1m where pedestrians are present.

Junction Capacity Operation

- 4.1.13 Junction capacity modelling has been undertaken using the LINSIG software. A summary of the results is shown in **Table 4.1** with the output report attached at **Appendix I**.
- 4.1.14 The results indicate that with 1,250 dwellings all arms of the junction operate with a Degree of Saturation below 100%. The modelling indicates that all queued vehicles will move through the junction using an optimised 180 second cycle time.
- 4.1.15 The latest design of the interim scheme has taken a slightly different approach, raising pedestrian movements and amenity for the Goldsmith Close properties above that of vehicle delay for the following reasons:
- Following the decision of OCC that the traffic associated with the Firethorn application (530 dwellings) did not have a 'severe' impact on delay at the junction and drivers will become accustomed to congestion on all routes into and around Bicester by 2026;
 - the impact of the development, given the future delivery of the SLR will be temporary;

- comments received from OCC on previous interim schemes requesting improved pedestrian movement and amenity.

4.1.16 Stage 1 and Stage 2 for Stream 1 at the northern junction have been altered to allow the opposed phase to run first.

Arm	Lane	AM			PM		
		DoS (%)	Queue (PCUs)	Delay s/PCU	DoS (%)	Queue (PCUs)	Delay s/PCU
2026 + Committed + 675 dwellings							
Bucknell Road (North)	-	38.2	9.2	52.6	52.3	10.7	68.7
A4095 (East)	Left	84.3	33.7	46.0	81.9	34.4	37.2
	Right	91.5	-	93.6	81.9	-	84.3
Bucknell Road (Internal Southbound)	-	97.4	12.1	27.7	97.3	7.5	14.3
Bucknell Road (South)	Left	96.6	38.3	105.8	82.5	27.6	67.6
A4095 (West)	Left	61.3	14.1	36.8	95.5	38.5	79.4
	Right	61.3	-	87.7	95.5	-	158.7
Bucknell Road (Internal Northbound)	Left	52.8	11.6	9.8	75.6	11.6	8.9
	Right	52.8	-	4.9	75.6	-	5.1
PRC (%)		-8.2			-8.1		
Cycle Time		180s					
2026 + Committed + 1250 dwellings							
Bucknell Road (North)	-	35.5	8.8	49.8	43.1	10.5	54.7
A4095 (East)	Left	88.5	37.7	53.8	84.1	35.8	42.0
	Right	96.6	-	98.8	90.0	-	95.9
Bucknell Road (Internal Southbound)	-	99.5	10.3	26.1	94.2	10.9	19.5
Bucknell Road (South)	Left	84.3	30.6	65.0	87.8	28.2	80.6
A4095 (West)	Left	65.5	14.2	41.6	87.4	31.5	52.1
	Right	65.5	-	100.0	87.4	-	133.6
Bucknell Road (Internal Northbound)	Left	52.6	11.6	9.1	73.5	11.4	8.0
	Right	52.6	-	3.9	73.5	-	3.5
PRC (%)		-10.5			-4.6		
Cycle Time		180s					

Table 4.1 – Summary of LINSIG Results for Signals Mitigation Scheme

4.1.17 The existing junction is known to be congested and, this congestion at a land constrained junction, is the main reason for the delivery of the SLR. The loss of the Homes England funding means that unless alternative funding is sourced, the cost of this expensive piece of infrastructure will have to be met by the developments that will increase traffic flows along the A4095. To enable the Hawkwell Village development to be able to fund its share of the SLR requires a period of house sales to be undertaken. The aim of this TN is to provide a mitigation solution that provides additional vehicle capacity until the developer is able to fund its share of the SLR; a positive of the design is that pedestrian safety can be improved through the provision of crossing facilities and the widening and ratification of existing footways.

- 4.1.18 OCC have commented that 180s cycle time is too long for pedestrian phases; this proposal is an interim scheme and OCC, as the highway network manager, is able to reduce the cycle time to improve pedestrian wait times at the expense of vehicle capacity. Additionally, the number of pedestrian movements through the junction is very low and the number of pedestrian movements that will use the crossing facilities is even lower; the Hawkwell Village acknowledged main pedestrian desire line will be along the active travel route adjacent to the railway line to the town centre and therefore, in practical terms there will not be a significant increase in pedestrian movements due to the development.
- 4.1.19 The queues on the A4095 eastern arm are significantly improved. With 1,250 dwellings there is a queue of 41 vehicles in the AM peak hour and 36 pcus in the PM peak hour both peak hours. Comparing the junction's operation in 2026 with development against the BTM '2026 Reference Case' there is a reduction in queues on this arm of 144 pcus in the AM peak hour and 158 pcus in the PM peak hour. Maximum delay reduces from 623s per pcu to 100s per pcu in the AM peak hour and from 638s per pcu to 86s per pcu in the PM peak hour, a saving of 8-9 minutes on travel times in the peak hours. These results indicate that the interim scheme will operate with a significantly lower level of delay than the 9 minutes deemed acceptable by OCC when considering the impact of traffic associated with the 530 Firethorn dwellings at the junctions.
- 4.1.20 The queues on the A4095 western arm also see a significant reduction generating a queue of 13 pcus in the AM peak hour and a queue of 39 pcus in the PM peak hour with the traffic generation of 1,250 dwellings and removes any knock-on impact on nearby junctions with the exception of the Avonbury Business Park junction in the PM peak hour. Comparing the junction's operation in 2026 with development against the 2026 Reference Case there is a reduction in queues on this arm of 40 pcus in the AM peak hour and 194 pcus in the PM peak hour. Maximum delay reduces from 292s per pcu to 88s per pcu in the AM peak hour and from 972s per pcu to 159s per pcu in the PM peak hour, a saving of 4 minutes in the AM peak hour and 13 minutes in the PM peak hour. These results indicate that the interim scheme will operate with a significantly lower level of delay than the 9 minutes deemed acceptable by OCC when considering the impact of traffic associated with the 530 Firethorn dwellings at the junctions.
- 4.1.21 The introduction of signals introduces a delay to the movements on Bucknell Road (i.e. north and south arms). However, the assessment of 1,250 dwellings, indicates a queue of 8 and 11 pcus on the Bucknell Road North arm in the AM and PM peak hours respectively and queues of 41 and 25 pcus on the Bucknell Road South arm in the AM and PM peak hours respectively. The predicted delay is considered within a normal range for a signalised junction in an urban environment and is below the 9 minutes deemed acceptable by OCC when considering the impact of traffic associated with the 530 Firethorn dwellings at the junctions.
- 4.1.22 The revised interim scheme differs from previous designs as it only provides a single lane approach on the Bucknell Road(S) arm in order to improve amenity for the Goldsmith Close properties and retain the existing trees; this change has meant that during the AM peak hour the vehicle queue will stretch across the Kingsley Road/Bucknell Road(S) junction and it is proposed to introduce 'Keep Clear' road markings.
- 4.1.23 **Figure 4.2** shows a visual representation of the predicted traffic queues for the '2026 Reference Case + 1250 dwellings' scenario.



Figure 4.2 – 2026 + 1250 Dwellings – Interim Scheme Predicted Vehicle Queue Lengths

5.0 Future Junction Design

- 5.1.1 From discussions with OCC it is apparent that the final scheme should provide significant active travel improvements and that a significantly different design to the interim scheme is considered to be required. As shown in previous versions of this TN, when the SLR is delivered there will be a significant reduction in vehicle movements through this junction and therefore, there will be an opportunity to design a scheme which reduces carriageway space and increases space for active travel routes.
- 5.1.2 A design for the future design of this junction is no longer included in this TN and will be provided at a later date following discussions with A2Dominion.
- 5.1.3 OCC have requested further detail in respect of the proposal to provide an all vehicle link road between the western Hawkwell Village site access and the Bucknell Road / A4095 existing roundabout junction i.e. to the south of the SLR. This all vehicle link road enables the removal of the previously proposed junction on the SLR to the east of the western site access and will reduce delay to vehicles on the SLR and delay/obstruction to the free flow of cycle movements on the southern side of the SLR.
- 5.1.4 The proposal is shown in the drawing attached at **Appendix J**; it should be noted that this drawing includes the previous ‘final solution’ scheme for the A405/Bucknell Road junctions which is now to be redesigned as mentioned above.
- 5.1.5 The proposal will be introduced alongside the proposed Bucknell Road traffic calming scheme that was introduced in Appendix B of TN05 and is reproduced at **Appendix K** of this report. The introduction of traffic calming measures has been designed to increase journey times along Bucknell Road and reduce the attractiveness of the route which is currently used to access the M40 Junction 10.

6.0 Summary and Conclusion

- 6.1.1 The existing Howes Lane (A4095) / Bucknell Road / A4095 junctions currently exceed capacity. Modelling of the two junctions for a ‘2026 + Committed Development’ scenario indicates that there will be significant queuing on the two A4095 arms and therefore, any further development would only increase the queues and journey times through the junction.

- 6.1.2 An interim mitigation scheme that signalises the two junctions and improves pedestrian severance is proposed to enable initial phases of the proposed Hawkwell Village development to come forward in order to enable funding of the A4095 Strategic Link Road. The scheme also improves articulated vehicle movement through the junction with HGVs accessing and egressing the Howes Lane arm no longer being reliant on the position of other vehicles within the junction.
- 6.1.3 Using traffic flows from the recently revalidated Bicester Transport Model and in accordance with the requirements of OCC, the junction modelling undertaken indicates that the proposed interim scheme will operate within capacity and offer a benefit to the existing configuration, to all road users in terms of queuing, journey times and crossing facilities for pedestrians, for at least 1,250 dwellings.
- 6.1.4 The reductions in terms of queues and delays at this junction would be extremely beneficial to the local transport network (both public and private modes) and the local economy and also enable the vital delivery of allocated housing at NW Bicester by enabling the occupation of dwellings from which the sale monies will enable funding of the SLR.
- 6.1.5 **Table 6.1** undertakes a comparison of the existing and proposed junction layouts and sets out the interim effects of the proposed scheme.

LOCATION	EXISTING JUNCTION	PROPOSED INTERIM JUNCTION 1250 DWELLINGS	EFFECT
PEDESTRIANS			
Crossing Facilities			
Bucknell Road (between the two existing junctions)	Uncontrolled crossing in close proximity of vehicles approaching from behind the line of vision	Controlled pedestrian crossing	Positive
Bucknell Road (S)	No crossing facilities	Controlled pedestrian crossing	Positive
A4095 (W)	Uncontrolled crossing across 3 lanes of traffic	Uncontrolled crossing with pedestrian refuge – 1 lane of traffic to be crossed on each movement	Positive
Footway Widths			
East of Bucknell Road	Varying width 1.0 – 1.5m	Widened to constant 2.0m	Positive
Bucknell Road(S) to A4095(W)	Varying width 1.5 – 1.9m	Widened to constant 2.0m	Positive
A4095(W) to Bucknell Road (immediately south of the railway bridge)	Varying width 1.7 – 2.0m	Constant 1.8m	Neutral The footway could be widened to 2.0m but this would narrow the

LOCATION	EXISTING JUNCTION	PROPOSED INTERIM JUNCTION 1250 DWELLINGS	EFFECT
			green area between the junction and Goldsmith Close properties by 200mm to 1.3m
CYCLISTS			
	No infrastructure. Cyclist/vehicles give-way to one another on the majority of movements through the junction.	No infrastructure. The provision of signals will reduce the number of give-way movements between vehicles and cyclists.	Neutral
ARTICULATED VEHICLES			
A4095(W) left-turn to Bucknell Road	Left-turning articulated vehicle have to use both lanes on approach. Articulated vehicles travel over the centre line of Bucknell Road requiring oncoming southbound vehicles to stop in an unexpected location.	Articulated vehicle manoeuvres take place entirely within the designated lane and do not cross the centre line into opposing traffic stream	Positive. There is an opportunity to increase the green area between the junction and Goldsmith Close by allowing left-turning articulated vehicles to use both lanes on the A4095(W) approach .
Bucknell road right-turn to A4095(W)	Articulated vehicles travel into the A4095(W) right turn approach lane.	Articulated vehicle manoeuvres take place entirely within the designated lane.	Positive
Whole Junction		Whilst articulated vehicles were only recorded travelling through the junction between the A4095(W) and A4095(E) arms, the design of the junction has been undertaken to enable or HGV movements to take place unopposed.	Positive

LOCATION	EXISTING JUNCTION	PROPOSED INTERIM JUNCTION 1250 DWELLINGS	EFFECT
JUNCTION OPERATION			
Delay			
A4095(W)	292/972s	88/159	Positive – Delay is 6 minutes less than the 9 minutes considered acceptable by OCC.
A4095(E)	623/638s	100/86	Positive – Delay is 7 minutes less than the 9 minutes considered acceptable by OCC
Bucknell Road(S)	1/1s	118/64	Positive – Delay is 7 minutes less than the 9 minutes considered acceptable by OCC.
Bucknell Road(N)	15/11s	44/61	Positive – Delay is 8 minutes less than the 9 minutes considered acceptable by OCC.
AMENITY – PROPERTIES ON GOLDSMITH CLOSE			
Goldsmith Close Properties		Approach has been narrowed to single lane on Bucknell Road (S) to retain existing distance between road and property boundaries. Junction geometry has been minimised to enable the retention of the existing trees and a 1.5m verge.	Neutral

- 6.1.6 The table indicates that the interim scheme would overall have a positive effect on the operation of the junction and the pedestrian environment.
- 6.1.7 The proposed interim mitigation scheme should be considered by OCC as an interim scheme to accommodate at least 1,250 dwellings at Hawkwell Village until the A4095 Strategic Road Link can be funded and delivered. Thereafter, given the future decrease in vehicle movements through the junction, a final solution scheme can be implemented which concentrates on active travel.

- 6.1.8 Whilst an interim mitigation scheme that offers reduced vehicle delay and active travel improvements for the junction has been presented within the TN, the decision of OCC Highways on the vehicle impact (i.e. temporary and not severe) of the Firethorn application for 530 dwellings is considered to be a material consideration on the need to mitigate for the vehicular impact of the Hawkwell Village development at the junction. Therefore, as well as a technical review of the proposed mitigation schemes, the position on the need to mitigate the temporary impact of the Hawkwell Village development traffic at the junction, is sought from OCC.

North West Bicester – Hawkwell Village

20300

Appendix A Bicester Traffic Model Outputs

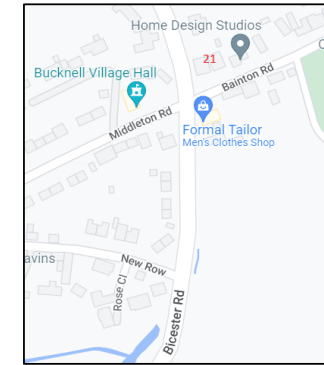
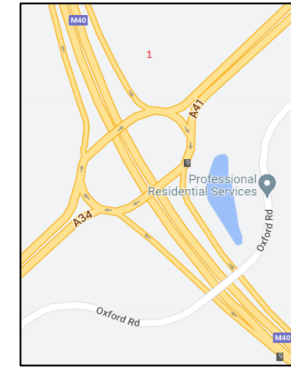
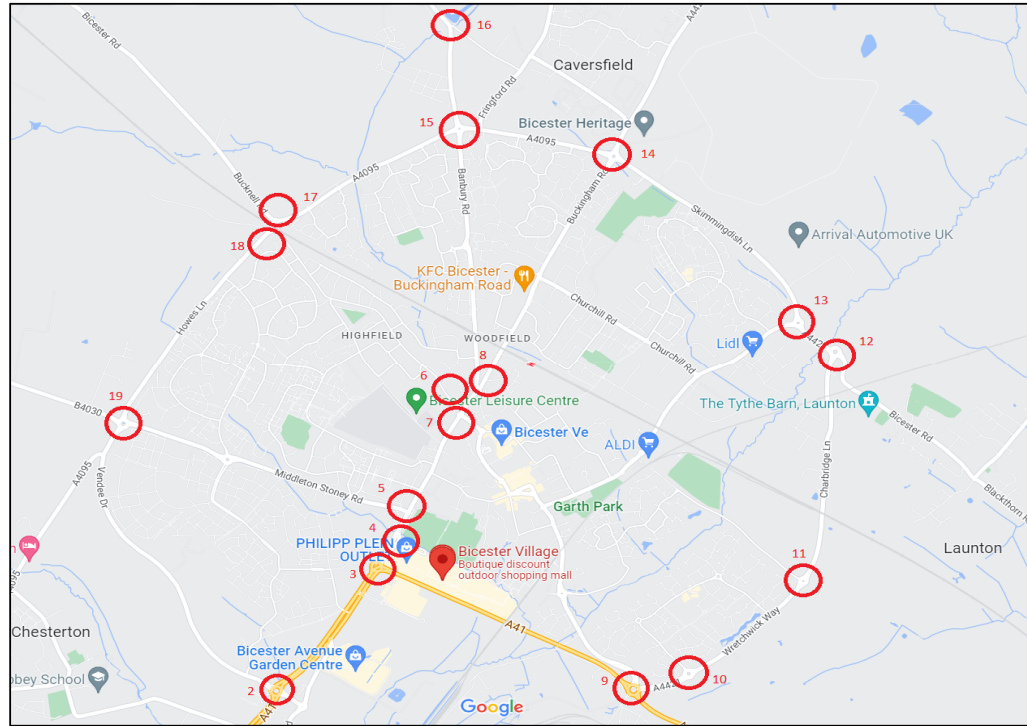

Ref No	Junction Name
1	M40 Junction 9
2	A41 / Vendee Drive roundabout
3	A41 / B4030 Oxford Road signalised roundabout
4	A41 Oxford Road / Pingle Drive signal junction
5	Middleton Stoney Road / Kings End mini roundabout
6	Field Street / Bucknell Road priority junction
7	Queens Avenue / St Johns Street mini roundabout
8	Banbury Road / Field Street mini roundabout
9	A41 / A4421 / B4100 / Gravenhill Road roundabout
10	A4421 / Peregrine Way roundabout
11	Wretchwick Way / Charbridge Lane / Gavray Dr roundabout
12	A4421 / Bicester Road roundabout

Ref No	Junction Name
13	A4421 / Launton Road / Skimmingish Lane roundabout
14	A4421 / Skimmingdish Lane / Buckingham Road / A4095 roundabout
15	B4100 Banbury Road / A4095 Lords Lane roundabout
16	B4100 / Caversfield priority junction
17	A4095 Lords Lane / Bucknell Road roundabout
18	Howes Lane / Bucknell Road priority junction
19	Howes Lane / Middleton Stoney Rd / Vendee Dr roundabout
20	M40 Junction 10
21	Middleton Road / Bainton Road priority junction
22	Site Access (Western)
23	Site Access (Eastern)

Turning Movement Data Junction Locations and References

Junction Reference	Junction Description	From Arm	To Arm	AM Peak							Inter Peak							PM Peak						
				Car	LGV	HGV (PCU)	HGV (Veh)	Bus (Veh)	Total Veh	Total PCUs	Car	LGV	HGV (PCU)	HGV (Veh)	Bus (Veh)	Total Veh	Total PCUs	Car	LGV	HGV (PCU)	HGV (Veh)	Bus (Veh)	Total Veh	Total PCUs
17	A4095 Lords Lane / Bucknell Road roundabout	Bucknell Road (N)	A4095 (E)	130	8	39	22	0	159	177	65	5	31	17	0	87	101	112	21	25	14	0	147	158
		Bucknell Road (N)	Bucknell Road (S)	23	19	23	13	0	55	65	40	15	20	11	0	66	75	26	30	5	3	0	59	61
		Bucknell Road (N)	Bucknell Road (N)	0	0	0	0	0	0	0	0	0	0	0	0	0	0	0	0	0	0	0	0	0
		A4095 (E)	Bucknell Road (S)	483	60	160	89	0	632	703	586	90	115	64	0	739	790	732	48	50	28	0	808	830
		A4095 (E)	Bucknell Road (N)	142	24	0	0	0	166	166	13	7	65	36	0	56	85	30	15	49	27	0	72	94
		A4095 (E)	A4095 (E)	0	0	0	0	0	0	0	0	0	0	0	0	0	0	0	0	0	0	0	0	0
		Bucknell Road (S)	Bucknell Road (N)	79	33	26	14	0	126	138	43	17	22	12	0	72	82	117	16	6	3	0	136	139
		Bucknell Road (S)	A4095 (E)	515	46	139	77	0	637	699	466	54	130	72	0	592	649	766	58	92	52	0	876	916
Bucknell Road (S)	Bucknell Road (S)	0	0	0	0	0	0	0	0	0	0	0	0	0	0	0	0	0	0	0	0	0		
18	Howes Lane / Bucknell Road priority junction	Bucknell Road (N)	Bucknell Road (S)	135	19	0	0	0	154	154	145	23	0	0	0	167	167	240	32	0	0	0	272	272
		Bucknell Road (N)	Howes Lane (W)	420	60	183	102	0	582	663	481	82	134	75	0	638	697	518	46	54	31	0	595	619
		Bucknell Road (S)	Howes Lane (W)	213	96	12	7	0	316	321	49	4	10	6	0	59	64	170	57	10	6	0	234	238
		Bucknell Road (S)	Bucknell Road (N)	278	32	2	1	0	312	313	145	14	2	1	0	160	161	296	20	2	1	0	317	318
		Howes Lane (W)	Bucknell Road (N)	316	46	162	90	0	452	524	365	56	150	83	0	505	571	586	55	96	54	0	695	737
		Howes Lane (W)	Bucknell Road (S)	12	1	0	0	0	14	14	18	1	0	0	0	19	19	8	0	3	2	0	10	11

Bicester Transport Model Junction Turning Movements (2026 Updated Reference Case Scenario)

Junction Reference	Junction Description	From Arm	To Arm	AM Peak							Inter Peak							PM Peak						
				Car	LGV	HGV (PCU)	HGV (Veh)	Bus (Veh)	Total Veh	Total PCUs	Car	LGV	HGV (PCU)	HGV (Veh)	Bus (Veh)	Total Veh	Total PCUs	Car	LGV	HGV (PCU)	HGV (Veh)	Bus (Veh)	Total Veh	Total PCUs
17	A4095 Lords Lane / Bucknell Road roundabout	Bucknell Road (N)	A4095 (E)	114	8	39	22	0	144	161	57	5	31	17	0	79	92	121	17	25	14	0	152	164
		Bucknell Road (N)	Bucknell Road (S)	23	19	23	13	0	55	65	49	15	20	11	0	76	84	56	30	7	4	0	89	92
		Bucknell Road (N)	Bucknell Road (N)	0	0	0	0	0	0	0	0	0	0	0	0	0	0	0	0	0	0	0	0	0
		A4095 (E)	Bucknell Road (S)	513	57	160	89	0	660	731	530	92	110	61	0	682	731	704	42	50	28	0	775	796
		A4095 (E)	Bucknell Road (N)	128	24	0	0	0	152	152	12	7	65	36	0	56	85	30	7	49	27	0	64	85
		A4095 (E)	A4095 (E)	0	0	0	0	0	0	0	0	0	0	0	0	0	0	0	0	0	0	0	0	0
		Bucknell Road (S)	Bucknell Road (N)	87	33	26	14	0	134	146	37	17	22	12	0	67	76	114	15	6	3	0	132	135
		Bucknell Road (S)	A4095 (E)	456	19	139	77	0	552	614	424	52	129	72	0	548	605	784	53	92	52	0	889	929
		Bucknell Road (S)	Bucknell Road (S)	0	0	0	0	0	0	0	0	0	0	0	0	0	0	0	0	0	0	0	0	
18	Howes Lane / Bucknell Road priority junction	Bucknell Road (N)	Bucknell Road (S)	153	19	0	0	0	172	172	147	21	0	0	0	168	168	249	32	0	0	0	281	281
		Bucknell Road (N)	Howes Lane (W)	430	57	183	102	0	589	670	432	86	130	72	0	590	647	511	40	56	32	0	583	608
		Bucknell Road (S)	Howes Lane (W)	218	96	12	7	0	321	326	45	0	10	6	0	51	56	119	63	10	6	0	188	192
		Bucknell Road (S)	Bucknell Road (N)	257	32	2	1	0	291	292	143	14	2	1	0	159	160	315	19	2	1	0	335	336
		Howes Lane (W)	Bucknell Road (N)	286	20	162	90	0	396	468	318	55	149	83	0	456	522	583	49	96	54	0	686	729
		Howes Lane (W)	Bucknell Road (S)	12	1	0	0	0	13	13	19	1	0	0	0	19	19	12	0	3	2	0	14	15

Bicester Transport Model Junction Turning Movements (2026 Hawkwell with Development 2a Scenario)

North West Bicester – Hawkwell Village

20300

Appendix B Traffic Flow Diagrams

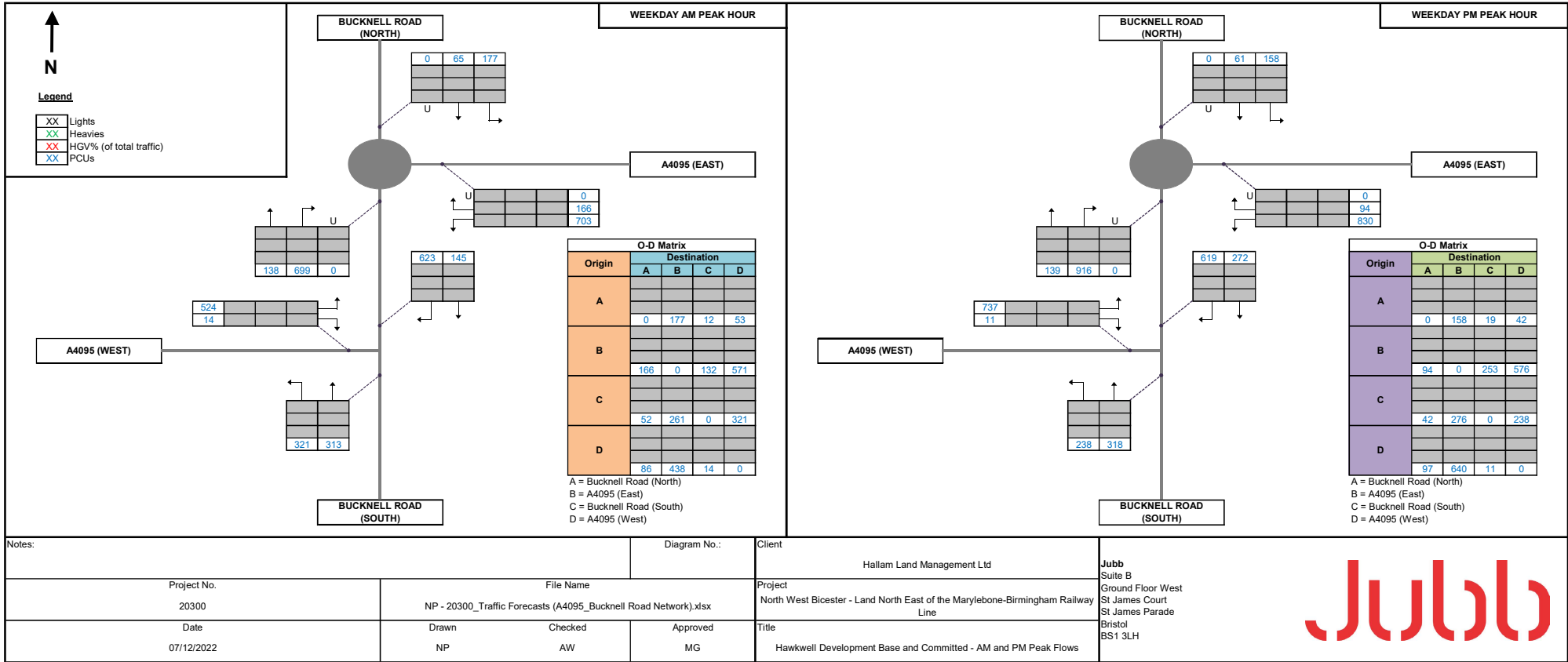

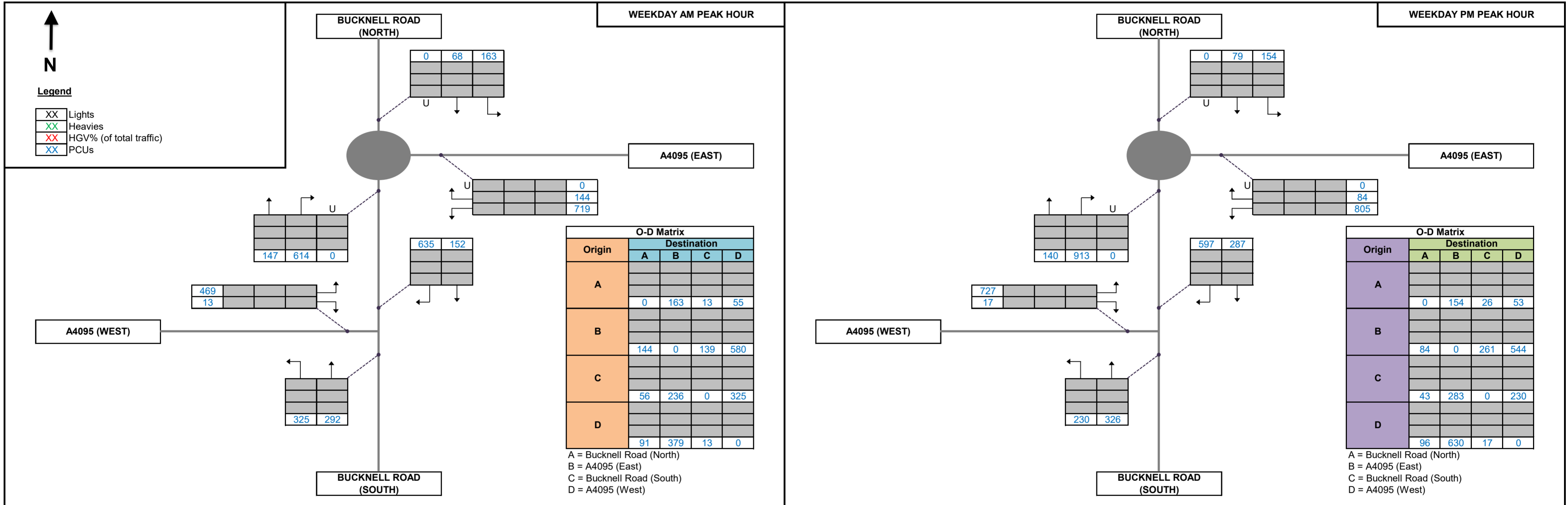

Notes:		Diagram No.:	Client	Jubb Suite B Ground Floor West St James Court St James Parade Bristol BS1 3LH
Project No.	File Name	Hallam Land Management Ltd		
20300	2026_Hawkwell_Dev1a_TurningMovements_and_LinkFlows_Values SR.xlsx	Project North West Bicester - Land North East of the Marylebone-Birmingham Railway Line		
Date	Drawn	Checked	Approved	
27/01/2023	NP	AW	MG	Title Year 2026 Hawkwell Development 1a - AM and PM Peak Flows



North West Bicester – Hawkwell Village

20300

Appendix C Existing Junction Vehicle Tracking



KEY

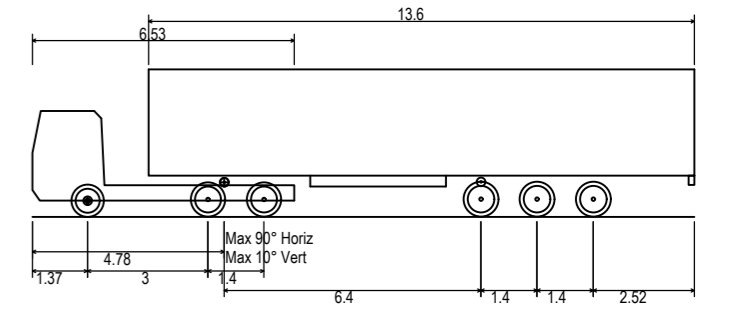

Max Legal Length (UK) Articulated Vehicle (16.5m) 16.500m
 Overall Length 2.550m
 Overall Width 3.681m
 Overall Body Height 0.411m
 Min Body Ground Clearance 2.500m
 Max Track Width 6.00s
 Lock to lock time 6.530m
 Kerb to Kerb Turning Radius

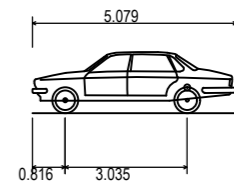

Large Car (2006) 5.079m
 Overall Length 1.872m
 Overall Width 1.525m
 Overall Body Height 0.310m
 Min Body Ground Clearance 1.831m
 Max Track Width 4.00s
 Lock to lock time 5.900m
 Kerb to Kerb Turning Radius

Rev	Date	Description	By	Apvd
P1	15.02.23	Preliminary issue	MK	AW

PROJECT:
Bicester

TITLE:
A4095 Priority Junction (Existing) Tracking

CLIENT:
Hallam Land Management

SCALE@A2:
1:500

PROJECT REF:
20300

DRAWING No: 041 **REV:** P1

Revision Referencing
P = Preliminary A = Approval T = Tender C = Construction



North West Bicester – Hawkwell Village

20300

Appendix D Junctions 10 Output Report – Existing Junctions

Junctions 10
ARCADY 10 - Roundabout Module PICADY 10 - Priority Intersection Module
Version: 10.0.4.1693 © Copyright TRL Software Limited, 2021
For sales and distribution information, program advice and maintenance, contact TRL Software: +44 (0)1344 379777 software@trl.co.uk trlsoftware.com
The users of this computer program for the solution of an engineering problem are in no way relieved of their responsibility for the correctness of the solution

Filename: A4095_Bucknell Road Junction Network (Existing)_Strategic Model Scenarios_2022.08.12 (Linked).j10
Path: S:\PROJECT FOLDER\20300 Bicester\Calculations\Transport\Junctions 10
Report generation date: 12/08/2022 10:25:34

- »Linked - Strategic Model Base + Committed, AM
- »Linked - Strategic Model Base + Committed, PM

Summary of junction performance

	AM			PM		
	Queue (PCU)	Delay (s)	RFC	Queue (PCU)	Delay (s)	RFC
Linked [Lane Simulation] - Strategic Model Base + Committed						
Junction 1 - Arm A	1.1	14.74		0.7	11.40	
Junction 1 - Arm B	184.6	622.83		193.5	638.13	
Junction 1 - Arm C	1.2	4.68		1.2	4.50	
Junction 2 - Arm A	0.2	0.68		0.1	0.47	
Junction 2 - Arm B	53.4	291.99		232.6	972.07	
Junction 2 - Arm C	3.1	16.51		3.0	14.67	

There are warnings associated with one or more model runs - see the 'Data Errors and Warnings' tables for each Analysis or Demand Set.

Values shown are the highest values encountered over all time segments. Delay is the maximum value of average delay per arriving vehicle. Arm and junction delays are averages for all movements, including movements with zero delay.

File summary

File Description

Title	A4095 / Bucknell Road Junction Network (Existing)
Location	Bicester, Oxfordshire
Site number	
Date	11/02/2022
Version	
Status	
Identifier	
Client	Hallam Land Management Ltd
Jobnumber	20300
Enumerator	JUBB\MattDavies
Description	

Units

Distance units	Speed units	Traffic units input	Traffic units results	Flow units	Average delay units	Total delay units	Rate of delay units
m	kph	PCU	PCU	perHour	s	-Min	perMin

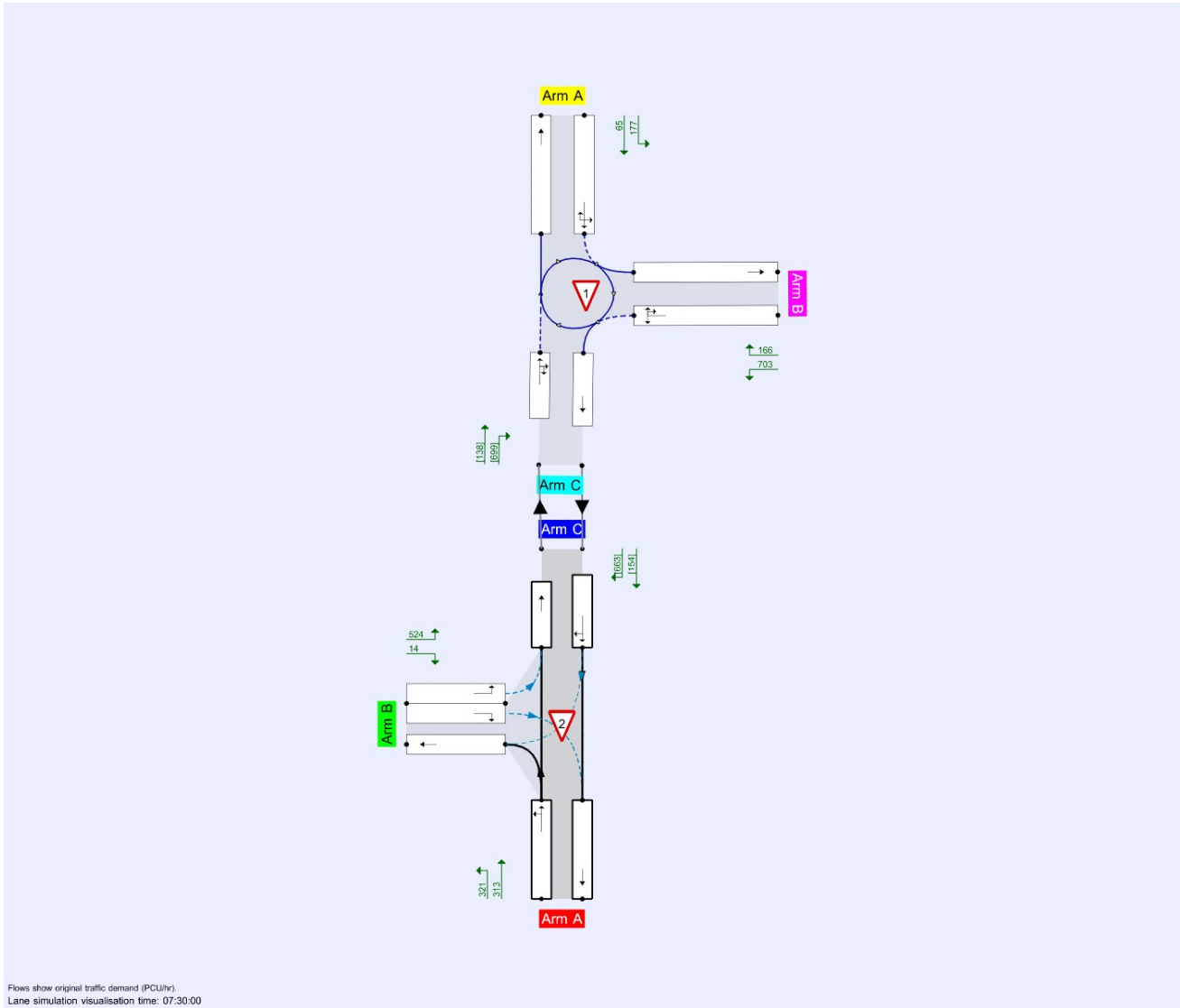

Flows show original traffic demand (PCU/hr). Lane simulation visualisation time: 07:30:00

The junction diagram reflects the last run of Junctions.

Analysis Options

Vehicle length (m)	Calculate Queue Percentiles	Calculate detailed queueing delay	Show lane queues in feet / metres	Show all PICADY stream intercepts	Calculate residual capacity	RFC Threshold	Average Delay threshold (s)	Queue threshold (PCU)	Use iterations with HCM roundabouts	Max number of iterations for roundabouts
5.75						0.85	36.00	20.00		500

Lane Simulation options

Criteria type	Stop criteria (%)	Stop criteria time (s)	Stop criteria number of trials	Random seed	Results refresh speed (s)	Individual vehicle animation number of trials	Average animation capture interval (s)	Use quick response	Do flow sampling	Suppress automatic lane creation	Last run random seed	Last run number of trials	Last run time taken (s)
Delay	1.00	100000	100000	-1	3	1	60	✓			1916309826	190	16.12

Demand Set Summary

ID	Scenario name	Time Period name	Traffic profile type	Start time (HH:mm)	Finish time (HH:mm)	Time period length (min)	Time segment length (min)	Run automatically
D1	Strategic Model Base + Committed	AM	FLAT	07:30	08:30	60	15	✓
D2	Strategic Model Base + Committed	PM	FLAT	16:15	17:15	60	15	✓

Analysis Set Details

ID	Name	Use Lane Simulation	Include in report	Network flow scaling factor (%)	Network capacity scaling factor (%)
A2	Linked	✓	✓	100.000	100.000

Linked - Strategic Model Base + Committed, AM

Data Errors and Warnings

Severity	Area	Item	Description
Last Run	Lane Simulation	Junction 2 - Arm B - Lane Simulation	Arm B: Queue at end of modelled period is greater than 10 PCU. Delay is likely to have been underestimated.
Last Run	Lane Simulation	Junction 1 - Arm B - Lane Simulation	Arm B: Queue at end of modelled period is greater than 10 PCU. Delay is likely to have been underestimated.
Info	Lane Simulation	A2 - Linked [Lane Simulation]	This analysis set uses Lane Simulation mode. For detailed information on this mode, please see the User Guide.

Junction Network

Junctions

Junction	Name	Junction type	Arm A Direction	Arm B Direction	Arm C Direction	Use circulating lanes	Arm order	Junction Delay (s)	Junction LOS
1	Bucknell Road / A4095 Roundabout	Standard Roundabout					A, B, C	288.72	F
2	Bucknell Road / A4095 Priority T-Junction	T-Junction	Two-way	Two-way	Two-way			93.00	F

Junction Network

Driving side	Lighting	Network delay (s)	Network LOS
Left	Normal/unknown	193.97	F

Arms

Arms

Junction	Arm	Name	Description	No give-way line	Arm type
1	A	Bucknell Road (North)			
	B	A4095 (East)			
	C	Bucknell Road (South)			
2	A	Bucknell Road (South)			Major
	B	A4095 Howes Lane (West)			Minor
	C	Bucknell Road (North)			Major

Roundabout Geometry

Junction	Arm	V - Approach road half-width (m)	E - Entry width (m)	I' - Effective flare length (m)	R - Entry radius (m)	D - Inscribed circle diameter (m)	PHI - Conflict (entry) angle (deg)	Entry only	Exit only
1	A	2.97	9.00	9.2	67.9	30.0	25.0		
	B	3.70	6.00	12.5	17.6	30.0	11.0		
	C	3.50	6.80	5.7	30.7	30.0	48.0		

Major Arm Geometry

Junction	Arm	Width of carriageway (m)	Has kerbed central reserve	Has right-turn storage	Visibility for right turn (m)	Blocks?	Blocking queue (PCU)	Vehicles causing blocking (%)
2	C	7.10			250.0	✓	0.00	100

Geometries for Arm C are measured opposite Arm B. Geometries for Arm A (if relevant) are measured opposite Arm D.

Minor Arm Geometry

Junction	Arm	Minor arm type	Lane Width (Left) (m)	Lane Width (Right) (m)	Visibility to left (m)	Visibility to right (m)
2	B	Two lanes	3.76	3.60	27	38

Slope / Intercept / Capacity

Roundabout Slope and Intercept used in model

Junction	Arm	Final slope	Final intercept (PCU/hr)
1	A	0.646	1565
	B	0.666	1652
	C	0.572	1347

The slope and intercept shown above include any corrections and adjustments.

Priority Intersection Slopes and Intercepts

Junction	Stream	Intercept (PCU/hr)	Slope for A-B	Slope for A-C	Slope for C-A	Slope for C-B
2	B-A	535	0.091	0.229	0.144	0.327
	B-C	697	0.104	0.263	-	-
	C-B	719	0.265	0.265	-	-

The slopes and intercepts shown above include custom intercept adjustments only.

Streams may be combined, in which case capacity will be adjusted.

Values are shown for the first time segment only; they may differ for subsequent time segments.

Lane Simulation: Arm options

Junction	Arm	Lane capacity source	Traffic considering secondary lanes (%)
1	A	Evenly split	10.00
	B	Evenly split	10.00
	C	Evenly split	10.00
2	A		10.00
	B		10.00
	C		10.00

Lanes

Junction	Arm	Side	Lane level	Lane	Destination arms	Has limited storage	Storage (PCU)	Has bottleneck	Has obstruction	Minimum capacity (PCU/hr)	Maximum capacity (PCU/hr)	Signalised	
1	A	Entry	1	1	A, B, C		Infinity			0	99999		
		Exit	1	1			Infinity						
	B	Entry	1	1	A, B, C		Infinity			0	99999		
		Exit	1	1			Infinity						
	C	Entry	1	1	A, B, C	✓	2.90				0	99999	
		Exit	1	1			✓	3.20					
2	A	Entry	1	1	B, C		Infinity			0	99999		
		Exit	1	1			Infinity						
	B	Entry	1	1	C		Infinity			0	99999		
		Exit	1	1	A		Infinity			0	99999		
	C	Entry	1	1	A, B	✓	3.20				0	99999	
		Exit	1	1			✓	2.90					

Entry Lane slope and intercept

Junction	Arm	Side	Lane level	Lane	Final slope	Final intercept (PCU/hr)
1	A	Entry	1	1	0.646	1565
	B	Entry	1	1	0.666	1652
	C	Entry	1	1	0.572	1347

Summary of Entry Lane allowed movements

Junction	Arm	Lane Level	Lane	Destination arm		
				A	B	C
2	A	1	1		✓	✓
	B	1	1			✓
			2	✓		
C	1	1	✓	✓		

Summary of Entry Lane allowed movements

Junction	Arm	Lane Level	Lane	Destination arm		
				A	B	C
1	A	1	1	✓	✓	✓
	B	1	1	✓	✓	✓
	C	1	1	✓	✓	✓

Traffic Demand

Demand Set Details

ID	Scenario name	Time Period name	Traffic profile type	Start time (HH:mm)	Finish time (HH:mm)	Time period length (min)	Time segment length (min)	Run automatically
D1	Strategic Model Base + Committed	AM	FLAT	07:30	08:30	60	15	✓

Vehicle mix varies over turn	Vehicle mix varies over entry	Vehicle mix source	PCU Factor for a HV (PCU)
✓	✓	HV Percentages	2.00

Linked Arm Data

Junction	Arm	Feeding Junction	Feeding Arm	Link Type	Flow source	Uniform flow (PCU/hr)	Flow multiplier (%)	Internal storage space (PCU)
1	C	2	C	Queue limited	Normal	0	100.00	10.00
2	C	1	C	Queue limited	Normal	0	100.00	10.00

Demand overview (Traffic)

Junction	Arm	Linked arm	Profile type	Use O-D data	Average Demand (PCU/hr)	Scaling Factor (%)
1	A		FLAT	✓	242	100.000
	B		FLAT	✓	869	100.000
	C	✓				
2	A		FLAT	✓	634	100.000
	B		FLAT	✓	538	100.000
	C	✓				

Origin-Destination Data

Demand (PCU/hr)

Junction 2

		To		
		A	B	C
From	A	0	321	313
	B	14	0	524
	C	154	663	0

Proportions

		To		
		A	B	C
From	A	0.00	0.51	0.49
	B	0.03	0.00	0.97
	C	0.19	0.81	0.00

Demand (PCU/hr)

Junction 1

		To		
		A	B	C
From	A	0	177	65
	B	166	0	703
	C	138	699	0

Proportions

		To		
		A	B	C
From	A	0.00	0.73	0.27
	B	0.19	0.00	0.81
	C	0.16	0.84	0.00

Vehicle Mix

Heavy Vehicle Percentages

Junction 2

		To		
		A	B	C
From	A	0	2	0
	B	0	0	20
	C	0	18	2

Average PCU Per Veh

		To		
		A	B	C
From	A	1.000	1.020	1.000
	B	1.000	1.000	1.200
	C	1.000	1.180	1.020

Heavy Vehicle Percentages

Junction 1

		To		
		A	B	C
From	A	0	10	5
	B	0	0	14
	C	11	12	0

Average PCU Per Veh

		To		
		A	B	C
From	A	1.000	1.100	1.050
	B	1.000	1.000	1.140
	C	1.110	1.120	1.000

Detailed Demand Data

Demand for each time segment

Time Segment	Junction	Arm	Demand (PCU/hr)	Demand in PCU (PCU/hr)
07:30-07:45	1	A	242	242
		B	869	869
		C	837	837
	2	A	634	634
		B	538	538
		C	817	817
07:45-08:00	1	A	242	242
		B	869	869
		C	837	837
	2	A	634	634
		B	538	538
		C	817	817
08:00-08:15	1	A	242	242
		B	869	869
		C	837	837
	2	A	634	634
		B	538	538
		C	817	817
08:15-08:30	1	A	242	242
		B	869	869
		C	837	837
	2	A	634	634
		B	538	538
		C	817	817

Results

Results Summary for whole modelled period

Junction	Arm	Max Delay (s)	Max Queue (PCU)	Max LOS	Average Demand (PCU/hr)	Total Junction Arrivals (PCU)
1	A	14.74	1.1	B	243	243
	B	622.83	184.6	F	875	875
	C	4.68	1.2	A	795	795
2	A	0.68	0.2	A	638	638
	B	291.99	53.4	F	535	535
	C	16.51	3.1	C	622	622

Main Results for each time segment

07:30 - 07:45

Junction	Arm	Total Demand (PCU/hr)	Junction Arrivals (PCU)	Circulating flow (PCU/hr)	Throughput (PCU/hr)	Average throughput (PCU/hr)	Throughput (exit side) (PCU/hr)	Start queue (PCU)	End queue (PCU)	Delay (s)	Unsignalised level of service
1	A	252	63	666	251	242	254	0.0	1.1	12.657	B
	B	876	219	66	686	682	850	0.0	47.1	131.186	F
	C	792	198	128	792	763	623	0.0	1.1	4.679	A
2	A	640	160		641	639	137	0.0	0.1	0.670	A
	B	533	133		480	461	832	0.0	19.6	95.782	F
	C	629	157		629	602	780	0.0	3.0	16.043	C

07:45 - 08:00

Junction	Arm	Total Demand (PCU/hr)	Junction Arrivals (PCU)	Circulating flow (PCU/hr)	Throughput (PCU/hr)	Average throughput (PCU/hr)	Throughput (exit side) (PCU/hr)	Start queue (PCU)	End queue (PCU)	Delay (s)	Unsignalised level of service
1	A	246	61	656	248	242	262	1.1	0.8	13.513	B
	B	877	219	63	679	693	841	47.1	89.8	358.179	F
	C	784	196	130	787	793	611	1.1	1.1	4.623	A
2	A	636	159		636	640	130	0.1	0.1	0.683	A
	B	531	133		478	482	822	19.6	32.3	199.576	F
	C	616	154		617	630	780	3.0	3.0	16.457	C

08:00 - 08:15

Junction	Arm	Total Demand (PCU/hr)	Junction Arrivals (PCU)	Circulating flow (PCU/hr)	Throughput (PCU/hr)	Average throughput (PCU/hr)	Throughput (exit side) (PCU/hr)	Start queue (PCU)	End queue (PCU)	Delay (s)	Unsignalised level of service
1	A	240	60	675	238	242	258	0.8	1.0	14.742	B
	B	872	218	63	666	682	849	89.8	136.9	603.275	F
	C	806	201	126	807	802	605	1.1	1.0	4.581	A
2	A	644	161		645	641	131	0.1	0.1	0.630	A
	B	539	135		502	496	832	32.3	44.0	281.870	F
	C	615	154		616	629	800	3.0	3.0	16.443	C

08:15 - 08:30

Junction	Arm	Total Demand (PCU/hr)	Junction Arrivals (PCU)	Circulating flow (PCU/hr)	Throughput (PCU/hr)	Average throughput (PCU/hr)	Throughput (exit side) (PCU/hr)	Start queue (PCU)	End queue (PCU)	Delay (s)	Unsignalised level of service
1	A	235	59	669	232	243	258	1.0	1.1	13.768	B
	B	877	219	59	689	681	842	136.9	184.6	622.829	F
	C	799	200	128	799	797	617	1.0	1.2	4.595	A
2	A	633	158		632	630	132	0.1	0.2	0.654	A
	B	538	134		494	497	827	44.0	53.4	291.991	F
	C	628	157		627	623	794	3.0	3.1	16.508	C

Lane Results

Lane Level notation: Lane Level 1 is always closest to the junction.

Lanes: Main Results for each time segment

07:30 - 07:45

Junction	Arm	Side	Lane level	Lane	Destination arms	Total Demand (PCU/hr)	Capacity (PCU/hr)	RFC	Throughput (PCU/hr)	Average throughput (PCU/hr)	Start queue (PCU)	End queue (PCU)	Delay (s)	Unsignalised level of service
1	A	Entry	1	1	A, B, C	252	1134	0.222	251	242	0.0	1.1	12.657	B
		Exit	1	1		254			254	251	0.0	0.0	0.000	A
	B	Entry	1	1	A, B, C	876	1608	0.545	686	682	0.0	47.1	131.186	F
		Exit	1	1		850			850	819	0.0	0.0	0.000	A
	C	Entry	1	1	A, B, C	792	1274	0.622	792	763	0.0	1.1	4.679	A
		Exit	1	1		624			623	608	0.0	2.3	12.158	B
2	A	Entry	1	1	B, C	640			641	639	0.0	0.1	0.670	A
		Exit	1	1		137			137	130	0.0	0.0	0.000	A
	B	Entry	1	1	C	519			466	447	0.0	19.6	98.394	F
		Exit	1	1	A	14			14	14	0.0	0.0	15.416	C
	C	Entry	1	1	A, B	629			629	602	0.0	3.0	16.043	C
		Exit	1	1		780			780	760	0.0	0.4	1.878	A

07:45 - 08:00

Junction	Arm	Side	Lane level	Lane	Destination arms	Total Demand (PCU/hr)	Capacity (PCU/hr)	RFC	Throughput (PCU/hr)	Average throughput (PCU/hr)	Start queue (PCU)	End queue (PCU)	Delay (s)	Unsignalised level of service
1	A	Entry	1	1	A, B, C	246	1141	0.216	248	242	1.1	0.8	13.513	B
		Exit	1	1		262			262	263	0.0	0.0	0.000	A
	B	Entry	1	1	A, B, C	877	1610	0.545	679	693	47.1	89.8	358.179	F
		Exit	1	1		841			841	841	0.0	0.0	0.000	A
	C	Entry	1	1	A, B, C	784	1273	0.616	787	793	1.1	1.1	4.623	A
		Exit	1	1		612			611	625	2.3	2.3	13.251	B
2	A	Entry	1	1	B, C	636			636	640	0.1	0.1	0.683	A
		Exit	1	1		130			130	134	0.0	0.0	0.000	A
	B	Entry	1	1	C	517			465	468	19.6	32.3	205.377	F
		Exit	1	1	A	14			14	14	0.0	0.1	17.428	C
	C	Entry	1	1	A, B	616			617	630	3.0	3.0	16.457	C
		Exit	1	1		779			780	788	0.4	0.4	1.901	A

08:00 - 08:15

Junction	Arm	Side	Lane level	Lane	Destination arms	Total Demand (PCU/hr)	Capacity (PCU/hr)	RFC	Throughput (PCU/hr)	Average throughput (PCU/hr)	Start queue (PCU)	End queue (PCU)	Delay (s)	Unsignalised level of service
1	A	Entry	1	1	A, B, C	240	1129	0.213	238	242	0.8	1.0	14.742	B
		Exit	1	1		258			258	262	0.0	0.0	0.000	A
	B	Entry	1	1	A, B, C	872	1610	0.541	666	682	89.8	136.9	603.275	F
		Exit	1	1		849			849	846	0.0	0.0	0.000	A
	C	Entry	1	1	A, B, C	806	1275	0.632	807	802	1.1	1.0	4.581	A
		Exit	1	1		603			605	619	2.3	2.2	13.557	B
2	A	Entry	1	1	B, C	644			645	641	0.1	0.1	0.630	A
		Exit	1	1		131			131	132	0.0	0.0	0.000	A
	B	Entry	1	1	C	525			487	482	32.3	43.9	290.399	F
		Exit	1	1		832			832	837	0.0	0.0	0.000	A
	C	Entry	1	1	A, B	615			616	629	3.0	3.0	16.443	C
		Exit	1	1		800			800	796	0.4	0.3	1.854	A

08:15 - 08:30

Junction	Arm	Side	Lane level	Lane	Destination arms	Total Demand (PCU/hr)	Capacity (PCU/hr)	RFC	Throughput (PCU/hr)	Average throughput (PCU/hr)	Start queue (PCU)	End queue (PCU)	Delay (s)	Unsignalised level of service
1	A	Entry	1	1	A, B, C	235	1132	0.207	232	243	1.0	1.1	13.768	B
		Exit	1	1		258			258	258	0.0	0.0	0.000	A
	B	Entry	1	1	A, B, C	877	1612	0.544	689	681	136.9	184.6	622.829	F
		Exit	1	1		842			842	847	0.0	0.0	0.000	A
	C	Entry	1	1	A, B, C	799	1274	0.627	799	797	1.0	1.2	4.595	A
		Exit	1	1		620			617	614	2.2	2.5	13.479	B
2	A	Entry	1	1	B, C	633			632	630	0.1	0.2	0.654	A
		Exit	1	1		132			132	130	0.0	0.0	0.000	A
	B	Entry	1	1	C	523			479	484	43.9	53.4	303.872	F
		Exit	1	1		827			827	825	0.0	0.0	0.000	A
	C	Entry	1	1	A, B	628			627	623	3.0	3.1	16.508	C
		Exit	1	1		795			794	795	0.3	0.5	1.825	A

Lane movements: Main Results for each time segment

07:30 - 07:45

Junction	Arm	Side	Lane level	Lane	To Arm	Total Demand (PCU/hr)	Junction Arrivals (PCU)	Simulation max flow (PCU/hr)	Capacity (PCU/hr)	RFC	Throughput (PCU/hr)	Average throughput (PCU/hr)	Start queue (PCU)	End queue (PCU)	Delay (s)	Unsignalised level of service
1	A	Entry	1	1	A	0	0	0	0	0.000	0	0	0.0	0.0	0.000	A
					B	185	46	1565	1137	0.162	184	177	0.0	0.6	9.912	A
					C	67	17	1565	1136	0.059	66	65	0.0	0.5	19.742	C
	B	Entry	1	1	A	161	40	1652	1607	0.100	128	129	0.0	8.6	127.488	F
					B	0	0	0	0	0.000	0	0	0.0	0.0	0.000	A
					C	715	179	1652	1607	0.445	558	553	0.0	38.5	132.164	F
	C	Entry	1	1	A	127	32	1347	1274	0.100	126	121	0.0	0.3	4.704	A
					B	665	166	1347	1274	0.522	666	642	0.0	0.8	4.674	A
					C	0	0	0	0	0.000	0	0	0.0	0.0	0.000	A
2	A	Entry	1	1	A	0	0	0	0	0.000	0	0	0.0	0.0	0.000	
					B	326	81	-	-	-	326	324	0.0	0.0	0.472	A
					C	315	79	-	-	-	315	315	0.0	0.1	0.868	A
	B	Entry	1	1	A	0	0	0	0	0.000	0	0	0.0	0.0	0.000	A
					B	0	0	0	0	0.000	0	0	0.0	0.0	0.000	
					C	519	130	697	574	0.904	466	447	0.0	19.6	98.394	F
				2	A	14	4	527	246	0.058	14	14	0.0	0.0	15.416	C
					B	0	0	0	0	0.000	0	0	0.0	0.0	0.000	
					C	0	0	0	0	0.000	0	0	0.0	0.0	0.000	A
C	Entry	1	1	A	122	30	-	-	-	122	116	0.0	0.3	11.252	B	
				B	508	127	719	548	0.926	506	486	0.0	2.7	17.381	C	
				C	0	0	0	0	0.000	0	0	0.0	0.0	0.000		

07:45 - 08:00

Junction	Arm	Side	Lane level	Lane	To Arm	Total Demand (PCU/hr)	Junction Arrivals (PCU)	Simulation max flow (PCU/hr)	Capacity (PCU/hr)	RFC	Throughput (PCU/hr)	Average throughput (PCU/hr)	Start queue (PCU)	End queue (PCU)	Delay (s)	Unsignalised level of service
1	A	Entry	1	1	A	0	0	0	0	0.000	0	0	0.0	0.0	0.000	A
					B	183	46	1565	1142	0.160	185	179	0.6	0.5	10.883	B
					C	63	16	1565	1144	0.055	63	63	0.5	0.3	20.628	C
	B	Entry	1	1	A	163	41	1652	1610	0.101	130	132	8.6	16.5	356.293	F
					B	0	0	0	0	0.000	0	0	0.0	0.0	0.000	A
					C	714	179	1652	1610	0.444	549	562	38.5	73.3	358.678	F
	C	Entry	1	1	A	131	33	1347	1273	0.103	131	132	0.3	0.2	4.534	A
					B	653	163	1347	1273	0.513	656	662	0.8	0.9	4.640	A
					C	0	0	0	0	0.000	0	0	0.0	0.0	0.000	A
2	A	Entry	1	1	A	0	0	0	0	0.000	0	0	0.0	0.0	0.000	
					B	322	80	-	-	-	321	321	0.0	0.1	0.454	A
					C	315	79	-	-	-	315	319	0.1	0.1	0.909	A
	B	Entry	1	1	A	0	0	0	0	0.000	0	0	0.0	0.0	0.000	A
					B	0	0	0	0	0.000	0	0	0.0	0.0	0.000	
					C	517	129	697	575	0.900	465	468	19.6	32.3	205.377	F
				2	A	14	3	524	241	0.057	14	14	0.0	0.1	17.428	C
					B	0	0	0	0	0.000	0	0	0.0	0.0	0.000	
					C	0	0	0	0	0.000	0	0	0.0	0.0	0.000	A
C	Entry	1	1	A	116	29	-	-	-	116	120	0.3	0.5	12.017	B	
				B	500	125	719	550	0.910	501	509	2.7	2.5	17.697	C	
				C	0	0	0	0	0.000	0	0	0.0	0.0	0.000		

08:00 - 08:15

Junction	Arm	Side	Lane level	Lane	To Arm	Total Demand (PCU/hr)	Junction Arrivals (PCU)	Simulation max flow (PCU/hr)	Capacity (PCU/hr)	RFC	Throughput (PCU/hr)	Average throughput (PCU/hr)	Start queue (PCU)	End queue (PCU)	Delay (s)	Unsignalised level of service
1	A	Entry	1	1	A	0	0	0	0	0.000	0	0	0.0	0.0	0.000	A
					B	175	44	1565	1129	0.155	174	178	0.5	0.5	11.691	B
					C	65	16	1565	1129	0.057	63	64	0.3	0.4	22.689	C
	B	Entry	1	1	A	165	41	1652	1611	0.102	126	128	16.5	25.8	599.790	F
					B	0	0	0	0	0.000	0	0	0.0	0.0	0.000	A
					C	707	177	1652	1610	0.439	540	554	73.3	111.1	604.204	F
	C	Entry	1	1	A	131	33	1347	1276	0.103	132	135	0.2	0.1	4.526	A
					B	674	169	1347	1275	0.529	675	668	0.9	0.9	4.592	A
					C	0	0	0	0	0.000	0	0	0.0	0.0	0.000	A
2	A	Entry	1	1	A	0	0	0	0	0.000	0	0	0.0	0.0	0.000	
					B	331	83	-	-	-	332	327	0.1	0.0	0.428	A
					C	313	78	-	-	-	313	314	0.1	0.1	0.836	A
	B	Entry	1	1	A	0	0	0	0	0.000	0	0	0.0	0.0	0.000	A
					B	0	0	0	0	0.000	0	0	0.0	0.0	0.000	
					C	525	131	697	575	0.912	487	482	32.3	43.9	290.399	F
				2	A	15	4	530	244	0.061	15	14	0.1	0.0	15.048	C
					B	0	0	0	0	0.000	0	0	0.0	0.0	0.000	
					C	0	0	0	0	0.000	0	0	0.0	0.0	0.000	A
C	Entry	1	1	A	116	29	-	-	-	116	118	0.5	0.3	11.824	B	
				B	499	125	719	547	0.912	500	511	2.5	2.6	17.705	C	
				C	0	0	0	0	0.000	0	0	0.0	0.0	0.000		

08:15 - 08:30

Junction	Arm	Side	Lane level	Lane	To Arm	Total Demand (PCU/hr)	Junction Arrivals (PCU)	Simulation max flow (PCU/hr)	Capacity (PCU/hr)	RFC	Throughput (PCU/hr)	Average throughput (PCU/hr)	Start queue (PCU)	End queue (PCU)	Delay (s)	Unsignalised level of service
1	A	Entry	1	1	A	0	0	0	0	0.000	0	0	0.0	0.0	0.000	A
					B	175	44	1565	1130	0.155	172	180	0.5	0.6	10.992	B
					C	60	15	1565	1131	0.053	59	62	0.4	0.5	21.421	C
	B	Entry	1	1	A	168	42	1652	1611	0.104	128	129	25.8	35.1	619.130	F
					B	0	0	0	0	0.000	0	0	0.0	0.0	0.000	A
					C	709	177	1652	1612	0.440	560	553	111.1	149.5	623.784	F
	C	Entry	1	1	A	130	32	1347	1275	0.102	129	129	0.1	0.2	4.622	A
					B	669	167	1347	1274	0.525	669	667	0.9	1.0	4.590	A
					C	0	0	0	0	0.000	0	0	0.0	0.0	0.000	A
2	A	Entry	1	1	A	0	0	0	0	0.000	0	0	0.0	0.0	0.000	
					B	317	79	-	-	-	317	318	0.0	0.1	0.442	A
					C	316	79	-	-	-	316	312	0.1	0.1	0.865	A
	B	Entry	1	1	A	0	0	0	0	0.000	0	0	0.0	0.0	0.000	A
					B	0	0	0	0	0.000	0	0	0.0	0.0	0.000	
					C	523	131	697	572	0.915	479	484	43.9	53.4	303.872	F
				2	A	15	4	515	241	0.062	15	14	0.0	0.1	15.713	C
					B	0	0	0	0	0.000	0	0	0.0	0.0	0.000	
					C	0	0	0	0	0.000	0	0	0.0	0.0	0.000	A
C	Entry	1	1	A	117	29	-	-	-	117	116	0.3	0.4	11.955	B	
				B	511	128	719	551	0.929	510	506	2.6	2.7	17.754	C	
				C	0	0	0	0	0.000	0	0	0.0	0.0	0.000		

Linked - Strategic Model Base + Committed, PM

Data Errors and Warnings

Severity	Area	Item	Description
Last Run	Lane Simulation	Junction 2 - Arm B - Lane Simulation	Arm B: Queue at end of modelled period is greater than 10 PCU. Delay is likely to have been underestimated.
Last Run	Lane Simulation	Junction 1 - Arm B - Lane Simulation	Arm B: Queue at end of modelled period is greater than 10 PCU. Delay is likely to have been underestimated.
Info	Lane Simulation	A2 - Linked [Lane Simulation]	This analysis set uses Lane Simulation mode. For detailed information on this mode, please see the User Guide.

Junction Network

Junctions

Junction	Name	Junction type	Arm A Direction	Arm B Direction	Arm C Direction	Use circulating lanes	Arm order	Junction Delay (s)	Junction LOS
1	Bucknell Road / A4095 Roundabout	Standard Roundabout					A, B, C	301.44	F
2	Bucknell Road / A4095 Priority T-Junction	T-Junction	Two-way	Two-way	Two-way			363.58	F

Junction Network

Driving side	Lighting	Network delay (s)	Network LOS
Left	Normal/unknown	332.77	F

Traffic Demand

Demand Set Details

ID	Scenario name	Time Period name	Traffic profile type	Start time (HH:mm)	Finish time (HH:mm)	Time period length (min)	Time segment length (min)	Run automatically
D2	Strategic Model Base + Committed	PM	FLAT	16:15	17:15	60	15	✓

Vehicle mix varies over turn	Vehicle mix varies over entry	Vehicle mix source	PCU Factor for a HV (PCU)
✓	✓	HV Percentages	2.00

Linked Arm Data

Junction	Arm	Feeding Junction	Feeding Arm	Link Type	Flow source	Uniform flow (PCU/hr)	Flow multiplier (%)	Internal storage space (PCU)
1	C	2	C	Queue limited	Normal	0	100.00	10.00
2	C	1	C	Queue limited	Normal	0	100.00	10.00

Demand overview (Traffic)

Junction	Arm	Linked arm	Profile type	Use O-D data	Average Demand (PCU/hr)	Scaling Factor (%)
1	A		FLAT	✓	219	100.000
	B		FLAT	✓	924	100.000
	C	✓				
2	A		FLAT	✓	556	100.000
	B		FLAT	✓	748	100.000
	C	✓				

Origin-Destination Data

Junction 2

Demand (PCU/hr)

		To		
		A	B	C
From	A	0	238	318
	B	11	0	737
	C	272	619	0

Proportions

		To		
		A	B	C
From	A	0.00	0.43	0.57
	B	0.01	0.00	0.99
	C	0.31	0.69	0.00

Junction 1

Demand (PCU/hr)

		To		
		A	B	C
From	A	0	158	61
	B	94	0	830
	C	139	916	0

Proportions

		To		
		A	B	C
From	A	0.00	0.72	0.28
	B	0.10	0.00	0.90
	C	0.13	0.87	0.00

Vehicle Mix

Junction 2

Heavy Vehicle Percentages

		To		
		A	B	C
From	A	0	2	0
	B	17	0	8
	C	0	5	0

Average PCU Per Veh

		To		
		A	B	C
From	A	1.000	1.020	1.000
	B	1.170	1.000	1.080
	C	1.000	1.050	1.000

Junction 1

Heavy Vehicle Percentages

		To		
		A	B	C
From	A	0	10	5
	B	38	0	3
	C	3	6	0

Average PCU Per Veh

		To		
		A	B	C
From	A	1.000	1.100	1.050
	B	1.380	1.000	1.030
	C	1.030	1.060	1.000

Detailed Demand Data

Demand for each time segment

Time Segment	Junction	Arm	Demand (PCU/hr)	Demand in PCU (PCU/hr)
16:15-16:30	1	A	219	219
		B	924	924
		C	1055	1055
	2	A	556	556
		B	748	748
		C	891	891
16:30-16:45	1	A	219	219
		B	924	924
		C	1055	1055
	2	A	556	556
		B	748	748
		C	891	891
16:45-17:00	1	A	219	219
		B	924	924
		C	1055	1055
	2	A	556	556
		B	748	748
		C	891	891
17:00-17:15	1	A	219	219
		B	924	924
		C	1055	1055
	2	A	556	556
		B	748	748
		C	891	891

Results

Results Summary for whole modelled period

Junction	Arm	Max Delay (s)	Max Queue (PCU)	Max LOS	Average Demand (PCU/hr)	Total Junction Arrivals (PCU)
1	A	11.40	0.7	B	221	221
	B	638.13	193.5	F	926	926
	C	4.50	1.2	A	834	834
2	A	0.47	0.1	A	557	557
	B	972.07	232.6	F	742	742
	C	14.67	3.0	B	715	715

Main Results for each time segment

16:15 - 16:30

Junction	Arm	Total Demand (PCU/hr)	Junction Arrivals (PCU)	Circulating flow (PCU/hr)	Throughput (PCU/hr)	Average throughput (PCU/hr)	Throughput (exit side) (PCU/hr)	Start queue (PCU)	End queue (PCU)	Delay (s)	Unsignalised level of service
1	A	217	54	723	216	214	183	0.0	0.7	9.687	A
	B	917	229	55	735	723	884	0.0	47.9	125.793	F
	C	833	208	72	834	821	713	0.0	1.0	4.472	A
2	A	563	141		564	563	223	0.0	0.0	0.397	A
	B	738	185		515	504	744	0.0	59.6	226.125	F
	C	714	179		712	687	823	0.0	3.0	14.255	B

16:30 - 16:45

Junction	Arm	Total Demand (PCU/hr)	Junction Arrivals (PCU)	Circulating flow (PCU/hr)	Throughput (PCU/hr)	Average throughput (PCU/hr)	Throughput (exit side) (PCU/hr)	Start queue (PCU)	End queue (PCU)	Delay (s)	Unsignalised level of service
1	A	227	57	720	226	222	180	0.7	0.7	11.308	B
	B	908	227	62	714	723	884	47.9	96.4	362.649	F
	C	830	208	71	829	829	707	1.0	1.2	4.501	A
2	A	559	140		559	559	229	0.0	0.0	0.472	A
	B	741	185		512	517	727	59.6	118.9	637.069	F
	C	708	177		709	711	824	3.0	2.9	14.675	B

16:45 - 17:00

Junction	Arm	Total Demand (PCU/hr)	Junction Arrivals (PCU)	Circulating flow (PCU/hr)	Throughput (PCU/hr)	Average throughput (PCU/hr)	Throughput (exit side) (PCU/hr)	Start queue (PCU)	End queue (PCU)	Delay (s)	Unsignalised level of service
1	A	228	57	730	227	222	183	0.7	0.6	11.404	B
	B	932	233	63	720	724	894	96.4	145.8	609.247	F
	C	838	209	77	836	825	709	1.2	1.0	4.472	A
2	A	556	139		557	547	231	0.0	0.0	0.431	A
	B	740	185		527	518	732	118.9	175.1	972.073	F
	C	713	178		714	717	835	2.9	2.9	14.483	B

17:00 - 17:15

Junction	Arm	Total Demand (PCU/hr)	Junction Arrivals (PCU)	Circulating flow (PCU/hr)	Throughput (PCU/hr)	Average throughput (PCU/hr)	Throughput (exit side) (PCU/hr)	Start queue (PCU)	End queue (PCU)	Delay (s)	Unsignalised level of service
1	A	211	53	721	213	220	191	0.6	0.6	10.823	B
	B	946	236	61	742	727	873	145.8	193.5	638.128	F
	C	835	209	78	834	838	726	1.0	1.1	4.382	A
2	A	550	137		549	553	233	0.0	0.1	0.452	A
	B	749	187		528	522	742	175.1	232.6	760.308	F
	C	724	181		723	714	824	2.9	3.0	14.500	B

Lane Results

Lane Level notation: Lane Level 1 is always closest to the junction.

Lanes: Main Results for each time segment

16:15 - 16:30

Junction	Arm	Side	Lane level	Lane	Destination arms	Total Demand (PCU/hr)	Capacity (PCU/hr)	RFC	Throughput (PCU/hr)	Average throughput (PCU/hr)	Start queue (PCU)	End queue (PCU)	Delay (s)	Unsignalised level of service
1	A	Entry	1	1	A, B, C	217	1098	0.198	216	214	0.0	0.7	9.687	A
		Exit	1	1		183			183	181	0.0	0.0	0.000	A
	B	Entry	1	1	A, B, C	917	1616	0.568	735	723	0.0	47.9	125.793	F
		Exit	1	1		884			884	870	0.0	0.0	0.000	A
	C	Entry	1	1	A, B, C	833	1306	0.638	834	821	0.0	1.0	4.472	A
		Exit	1	1		717			713	698	0.0	2.3	10.296	B
2	A	Entry	1	1	B, C	563			564	563	0.0	0.0	0.397	A
		Exit	1	1		223			223	219	0.0	0.0	0.000	A
	B	Entry	1	1	C	727			504	493	0.0	59.5	228.933	F
		Exit	1	1	A	11			11	10	0.0	0.1	17.779	C
	C	Entry	1	1	A, B	714			712	687	0.0	3.0	14.255	B
		Exit	1	1		822			823	815	0.0	0.2	1.554	A

16:30 - 16:45

Junction	Arm	Side	Lane level	Lane	Destination arms	Total Demand (PCU/hr)	Capacity (PCU/hr)	RFC	Throughput (PCU/hr)	Average throughput (PCU/hr)	Start queue (PCU)	End queue (PCU)	Delay (s)	Unsignalised level of service
1	A	Entry	1	1	A, B, C	227	1100	0.206	226	222	0.7	0.7	11.308	B
		Exit	1	1		180			180	183	0.0	0.0	0.000	A
	B	Entry	1	1	A, B, C	908	1610	0.564	714	723	47.9	96.4	362.649	F
		Exit	1	1		884			884	880	0.0	0.0	0.000	A
	C	Entry	1	1	A, B, C	830	1307	0.635	829	829	1.0	1.2	4.501	A
		Exit	1	1		705			707	710	2.3	2.2	11.428	B
2	A	Entry	1	1	B, C	559			559	559	0.0	0.0	0.472	A
		Exit	1	1		229			229	226	0.0	0.0	0.000	A
	B	Entry	1	1	C	729			500	506	59.5	118.8	645.701	F
		Exit	1	1	A	12			11	11	0.1	0.1	17.132	C
	B	Entry	1	2		727			727	737	0.0	0.0	0.000	A
		Exit	1	1		727			727	737	0.0	0.0	0.000	A
	C	Entry	1	1	A, B	708			709	711	3.0	2.9	14.675	B
		Exit	1	1		824			824	824	0.2	0.4	1.637	A

16:45 - 17:00

Junction	Arm	Side	Lane level	Lane	Destination arms	Total Demand (PCU/hr)	Capacity (PCU/hr)	RFC	Throughput (PCU/hr)	Average throughput (PCU/hr)	Start queue (PCU)	End queue (PCU)	Delay (s)	Unsignalised level of service
1	A	Entry	1	1	A, B, C	228	1093	0.209	227	222	0.7	0.6	11.404	B
		Exit	1	1		183			183	176	0.0	0.0	0.000	A
	B	Entry	1	1	A, B, C	932	1610	0.579	720	724	96.4	145.8	609.247	F
		Exit	1	1		894			894	881	0.0	0.0	0.000	A
	C	Entry	1	1	A, B, C	838	1304	0.643	836	825	1.2	1.0	4.472	A
		Exit	1	1		707			709	715	2.2	2.0	11.419	B
2	A	Entry	1	1	B, C	556			557	547	0.0	0.0	0.431	A
		Exit	1	1		231			231	232	0.0	0.0	0.000	A
	B	Entry	1	1	C	730			518	507	118.8	175.0	987.008	F
		Exit	1	1	A	10			10	12	0.1	0.1	21.300	C
	B	Entry	1	2		732			732	730	0.0	0.0	0.000	A
		Exit	1	1		732			732	730	0.0	0.0	0.000	A
	C	Entry	1	1	A, B	713			714	717	2.9	2.9	14.483	B
		Exit	1	1		835			835	821	0.4	0.3	1.619	A

17:00 - 17:15

Junction	Arm	Side	Lane level	Lane	Destination arms	Total Demand (PCU/hr)	Capacity (PCU/hr)	RFC	Throughput (PCU/hr)	Average throughput (PCU/hr)	Start queue (PCU)	End queue (PCU)	Delay (s)	Unsignalised level of service
1	A	Entry	1	1	A, B, C	211	1099	0.192	213	220	0.6	0.6	10.823	B
		Exit	1	1		191			191	184	0.0	0.0	0.000	A
	B	Entry	1	1	A, B, C	946	1612	0.587	742	727	145.8	193.5	638.128	F
		Exit	1	1		873			873	887	0.0	0.0	0.000	A
	C	Entry	1	1	A, B, C	835	1303	0.641	834	838	1.0	1.1	4.382	A
		Exit	1	1		724			726	713	2.0	2.2	11.239	B
2	A	Entry	1	1	B, C	550			549	553	0.0	0.1	0.452	A
		Exit	1	1		233			233	229	0.0	0.0	0.000	A
	B	Entry	1	1	C	739			516	511	175.0	232.6	847.459	F
		Exit	1	1	A	11			11	11	0.1	0.0	15.715	C
	B	Entry	1	2		742			742	733	0.0	0.0	0.000	A
		Exit	1	1		742			742	733	0.0	0.0	0.000	A
	C	Entry	1	1	A, B	724			723	714	2.9	3.0	14.500	B
		Exit	1	1		824			824	827	0.3	0.3	1.557	A

Lane movements: Main Results for each time segment

16:15 - 16:30

Junction	Arm	Side	Lane level	Lane	To Arm	Total Demand (PCU/hr)	Junction Arrivals (PCU)	Simulation max flow (PCU/hr)	Capacity (PCU/hr)	RFC	Throughput (PCU/hr)	Average throughput (PCU/hr)	Start queue (PCU)	End queue (PCU)	Delay (s)	Unsignalised level of service
1	A	Entry	1	1	A	0	0	0	0	0.000	0	0	0.0	0.0	0.000	A
					B	161	40	1565	1096	0.147	161	159	0.0	0.3	7.622	A
					C	56	14	1565	1092	0.051	55	56	0.0	0.3	15.194	C
	B	Entry	1	1	A	92	23	1652	1614	0.057	72	71	0.0	4.7	121.911	F
					B	0	0	0	0	0.000	0	0	0.0	0.0	0.000	A
					C	825	206	1652	1615	0.510	662	652	0.0	43.2	126.113	F
	C	Entry	1	1	A	110	28	1347	1307	0.084	111	110	0.0	0.1	4.403	A
					B	722	181	1347	1306	0.553	723	711	0.0	0.8	4.483	A
					C	0	0	0	0	0.000	0	0	0.0	0.0	0.000	A
2	A	Entry	1	1	A	0	0	0	0	0.000	0	0	0.0	0.0	0.000	
					B	245	61	-	-	-	245	240	0.0	0.0	0.240	A
					C	318	80	-	-	-	319	323	0.0	0.0	0.512	A
	B	Entry	1	1	A	0	0	0	0	0.000	0	0	0.0	0.0	0.000	A
					B	0	0	0	0	0.000	0	0	0.0	0.0	0.000	
					C	727	182	697	579	1.256	504	493	0.0	59.5	228.933	F
				2	A	11	3	472	224	0.049	11	10	0.0	0.1	17.779	C
					B	0	0	0	0	0.000	0	0	0.0	0.0	0.000	
					C	0	0	0	0	0.000	0	0	0.0	0.0	0.000	A
C	Entry	1	1	A	212	53	-	-	-	213	208	0.0	0.7	10.817	B	
				B	502	125	719	569	0.882	499	479	0.0	2.3	15.815	C	
				C	0	0	0	0	0.000	0	0	0.0	0.0	0.000		

16:30 - 16:45

Junction	Arm	Side	Lane level	Lane	To Arm	Total Demand (PCU/hr)	Junction Arrivals (PCU)	Simulation max flow (PCU/hr)	Capacity (PCU/hr)	RFC	Throughput (PCU/hr)	Average throughput (PCU/hr)	Start queue (PCU)	End queue (PCU)	Delay (s)	Unsignalised level of service
1	A	Entry	1	1	A	0	0	0	0	0.000	0	0	0.0	0.0	0.000	A
					B	166	41	1565	1103	0.150	164	161	0.3	0.5	8.925	A
					C	61	15	1565	1103	0.056	62	61	0.3	0.2	17.395	C
	B	Entry	1	1	A	83	21	1652	1611	0.052	71	74	4.7	9.1	350.243	F
					B	0	0	0	0	0.000	0	0	0.0	0.0	0.000	A
					C	825	206	1652	1610	0.512	643	649	43.2	87.3	363.701	F
	C	Entry	1	1	A	109	27	1347	1304	0.083	109	110	0.1	0.1	4.520	A
					B	722	181	1347	1307	0.553	720	719	0.8	1.1	4.498	A
					C	0	0	0	0	0.000	0	0	0.0	0.0	0.000	A
2	A	Entry	1	1	A	0	0	0	0	0.000	0	0	0.0	0.0	0.000	
					B	235	59	-	-	-	235	241	0.0	0.0	0.314	A
					C	324	81	-	-	-	324	319	0.0	0.0	0.590	A
	B	Entry	1	1	A	0	0	0	0	0.000	0	0	0.0	0.0	0.000	A
					B	0	0	0	0	0.000	0	0	0.0	0.0	0.000	
					C	729	182	697	580	1.257	500	506	59.5	118.8	645.701	F
				2	A	12	3	493	220	0.054	11	11	0.1	0.1	17.132	C
					B	0	0	0	0	0.000	0	0	0.0	0.0	0.000	
					C	0	0	0	0	0.000	0	0	0.0	0.0	0.000	A
C	Entry	1	1	A	217	54	-	-	-	218	215	0.7	0.6	11.567	B	
				B	491	123	719	570	0.860	491	496	2.3	2.3	16.082	C	
				C	0	0	0	0	0.000	0	0	0.0	0.0	0.000		

16:45 - 17:00

Junction	Arm	Side	Lane level	Lane	To Arm	Total Demand (PCU/hr)	Junction Arrivals (PCU)	Simulation max flow (PCU/hr)	Capacity (PCU/hr)	RFC	Throughput (PCU/hr)	Average throughput (PCU/hr)	Start queue (PCU)	End queue (PCU)	Delay (s)	Unsignalised level of service
1	A	Entry	1	1	A	0	0	0	0	0.000	0	0	0.0	0.0	0.000	A
					B	166	41	1565	1093	0.151	164	160	0.5	0.4	8.622	A
					C	63	16	1565	1095	0.058	63	62	0.2	0.2	18.233	C
	B	Entry	1	1	A	99	25	1652	1609	0.061	77	72	9.1	14.9	612.775	F
					B	0	0	0	0	0.000	0	0	0.0	0.0	0.000	A
					C	833	208	1652	1610	0.517	644	653	87.3	130.9	608.946	F
	C	Entry	1	1	A	107	27	1347	1303	0.082	107	104	0.1	0.2	4.304	A
					B	731	183	1347	1304	0.560	730	721	1.1	0.9	4.497	A
					C	0	0	0	0	0.000	0	0	0.0	0.0	0.000	A
2	A	Entry	1	1	A	0	0	0	0	0.000	0	0	0.0	0.0	0.000	
					B	240	60	-	-	-	240	233	0.0	0.0	0.220	A
					C	317	79	-	-	-	317	314	0.0	0.0	0.583	A
	B	Entry	1	1	A	0	0	0	0	0.000	0	0	0.0	0.0	0.000	A
					B	0	0	0	0	0.000	0	0	0.0	0.0	0.000	
					C	730	182	697	577	1.264	518	507	118.8	175.0	987.008	F
				2	A	10	3	472	218	0.047	10	12	0.1	0.1	21.300	C
					B	0	0	0	0	0.000	0	0	0.0	0.0	0.000	
					C	0	0	0	0	0.000	0	0	0.0	0.0	0.000	A
C	Entry	1	1	A	221	55	-	-	-	222	220	0.6	0.7	11.318	B	
				B	492	123	719	571	0.861	492	497	2.3	2.3	15.960	C	
				C	0	0	0	0	0.000	0	0	0.0	0.0	0.000		

17:00 - 17:15

Junction	Arm	Side	Lane level	Lane	To Arm	Total Demand (PCU/hr)	Junction Arrivals (PCU)	Simulation max flow (PCU/hr)	Capacity (PCU/hr)	RFC	Throughput (PCU/hr)	Average throughput (PCU/hr)	Start queue (PCU)	End queue (PCU)	Delay (s)	Unsignalised level of service
1	A	Entry	1	1	A	0	0	0	0	0.000	0	0	0.0	0.0	0.000	A
					B	152	38	1565	1098	0.139	152	159	0.4	0.4	8.413	A
					C	59	15	1565	1099	0.054	61	60	0.2	0.2	16.920	C
	B	Entry	1	1	A	95	24	1652	1611	0.059	78	74	14.9	18.9	633.211	F
					B	0	0	0	0	0.000	0	0	0.0	0.0	0.000	A
					C	851	213	1652	1611	0.528	664	653	130.9	174.7	638.517	F
	C	Entry	1	1	A	112	28	1347	1304	0.086	112	110	0.2	0.1	4.369	A
					B	723	181	1347	1303	0.555	721	728	0.9	0.9	4.384	A
					C	0	0	0	0	0.000	0	0	0.0	0.0	0.000	A
2	A	Entry	1	1	A	0	0	0	0	0.000	0	0	0.0	0.0	0.000	
					B	241	60	-	-	-	241	237	0.0	0.0	0.256	A
					C	308	77	-	-	-	308	316	0.0	0.0	0.596	A
	B	Entry	1	1	A	0	0	0	0	0.000	0	0	0.0	0.0	0.000	A
					B	0	0	0	0	0.000	0	0	0.0	0.0	0.000	
					C	739	185	697	588	1.256	516	511	175.0	232.6	847.459	F
				2	A	11	3	498	235	0.046	11	11	0.1	0.0	15.715	C
					B	0	0	0	0	0.000	0	0	0.0	0.0	0.000	
					C	0	0	0	0	0.000	0	0	0.0	0.0	0.000	A
C	Entry	1	1	A	222	55	-	-	-	221	218	0.7	0.6	11.393	B	
				B	502	126	719	573	0.876	502	496	2.3	2.4	15.941	C	
				C	0	0	0	0	0.000	0	0	0.0	0.0	0.000		



North West Bicester – Hawkwell Village

20300

Appendix E Proposed Signalisation Interim Mitigation Scheme

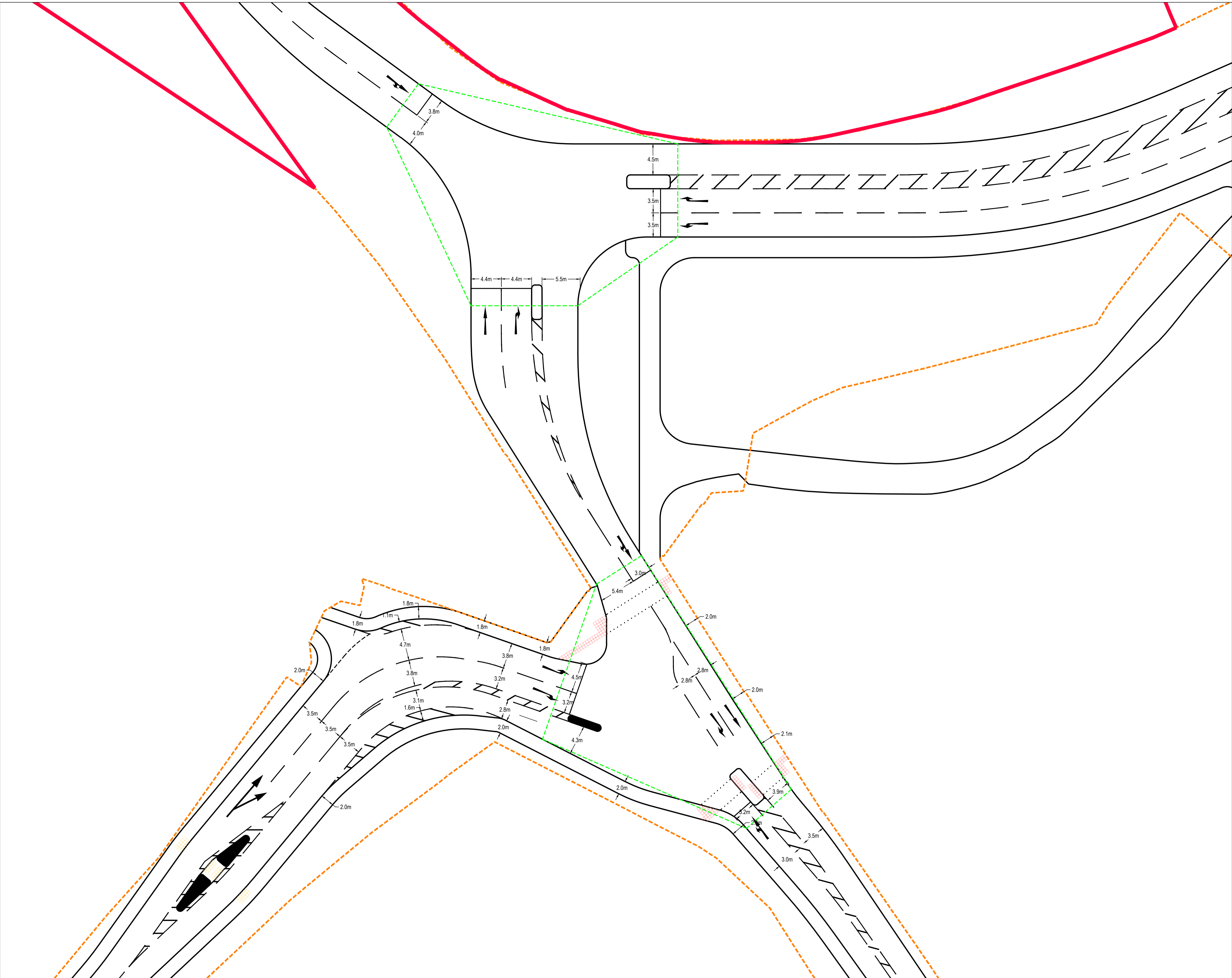

KEY

- Site Boundary
- Highway Boundary
- Intervisibility

P2	16.02.23	Junction Amended	MK	AW
P1	20.12.22	Preliminary issue	MK	AW
<i>Rev</i>	<i>Date</i>	<i>Description</i>	<i>By</i>	<i>Apvd</i>

PROJECT:
BICESTER

TITLE:
BUCKNELL ROAD -
A4095 SIGNALIZED JUNCTION

CLIENT:
HALLAM LAND MANAGEMENT

SCALE@A1:
1:250

PROJECT REF:
20300
DRAWING No: 031
REV: P3

Revision Referencing
P = Preliminary A = Approval T = Tender C = Construction



North West Bicester – Hawkwell Village

20300

Appendix F Proposed Signalisation Interim Mitigation Scheme Vehicle Tracking

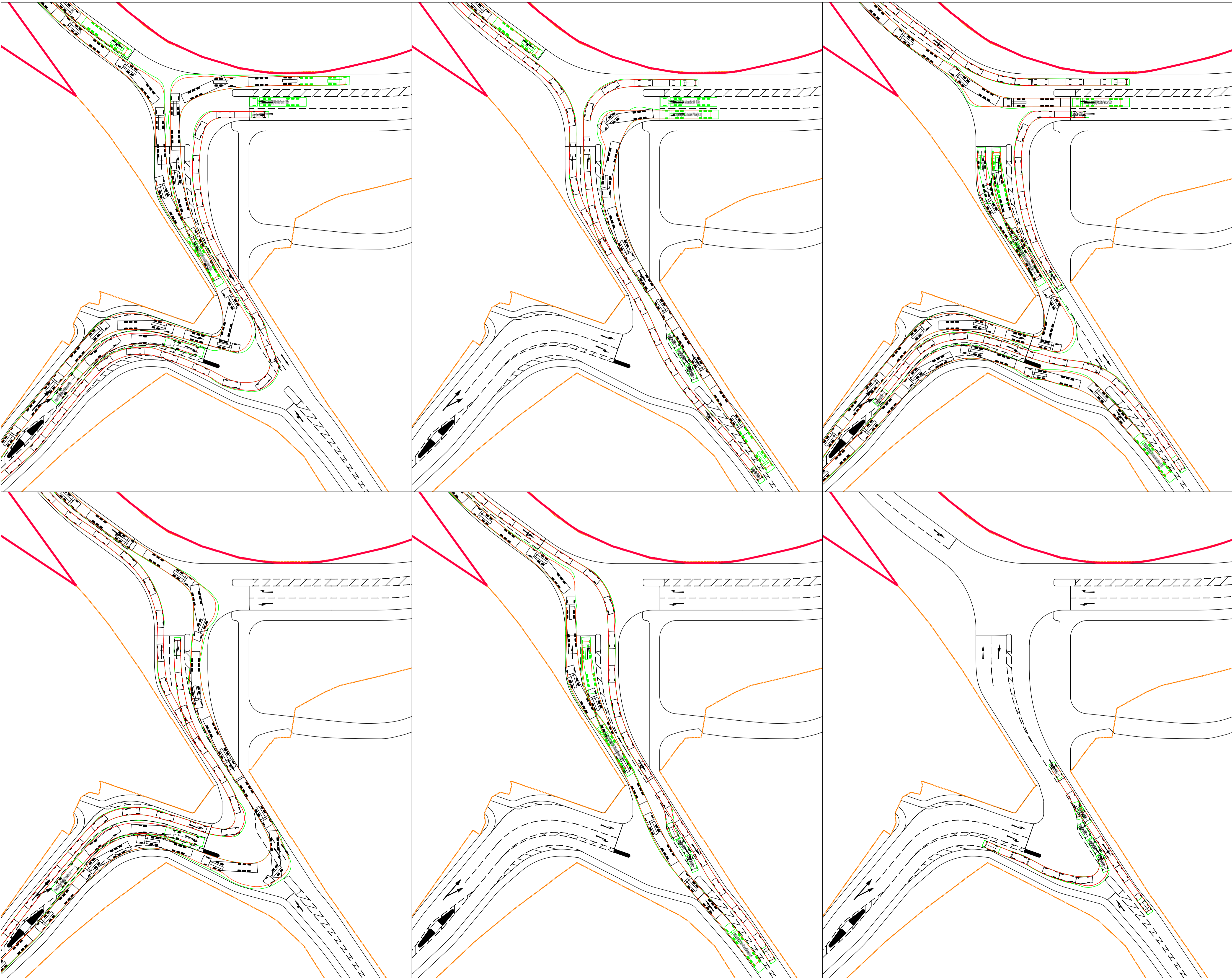

KEY

- Site Boundary
- Highway Boundary

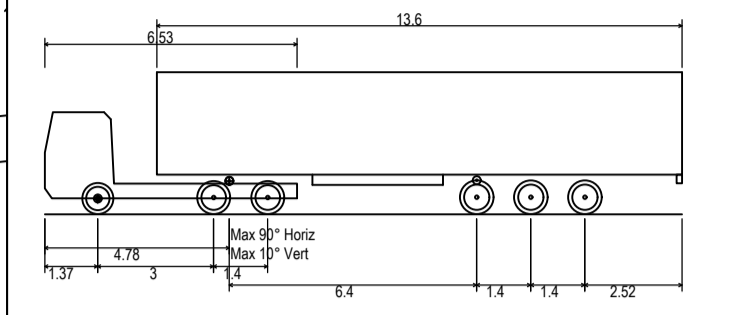

Max Legal Length (UK) Articulated Vehicle (16.5m)
 Overall Length 16.500m
 Overall Width 2.550m
 Overall Body Height 3.681m
 Min Body Ground Clearance 0.411m
 Max Track Width 2.500m
 Lock to lock time 6.00s
 Kerb to Kerb Turning Radius 6.530m

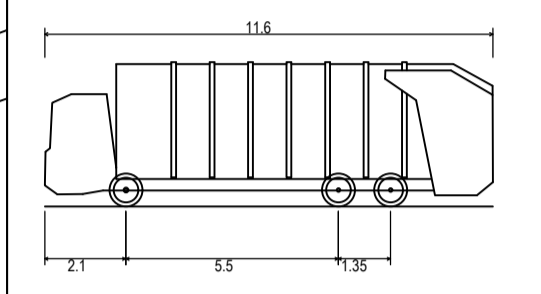

Phoenix 2-17N (with Elite 2 6x2 RS chassis) 11.6m
 Overall Length 11.600m
 Overall Width 2.550m
 Overall Body Height 3.742m
 Min Body Ground Clearance 0.295m
 Track Width 2.450m
 Lock to lock time 4.00s
 Kerb to Kerb Turning Radius 7.900m

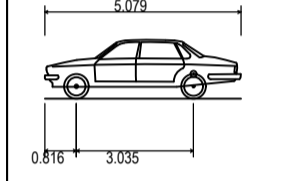

Large Car (2006)
 Overall Length 5.079m
 Overall Width 1.872m
 Overall Body Height 1.526m
 Min Body Ground Clearance 0.310m
 Max Track Width 1.831m
 Lock to lock time 4.00s
 Kerb to Kerb Turning Radius 5.900m

Rev	Date	Description	By	Apvd
P2	17.02.23	Junction Amended	MK	AW
P1	06.01.23	Preliminary issue	MK	AW

PROJECT:
 BICESTER

TITLE:
 BUCKNELL ROAD - A4095 SIGNALISED JUNCTION TRACKING

CLIENT:
 HALLAM LAND MANAGEMENT

SCALE@A1:
 1:500

PROJECT REF:
 20300
DRAWING No: 032 **REV:** P2

Revision Referencing
 P = Preliminary A = Approval T = Tender C = Construction





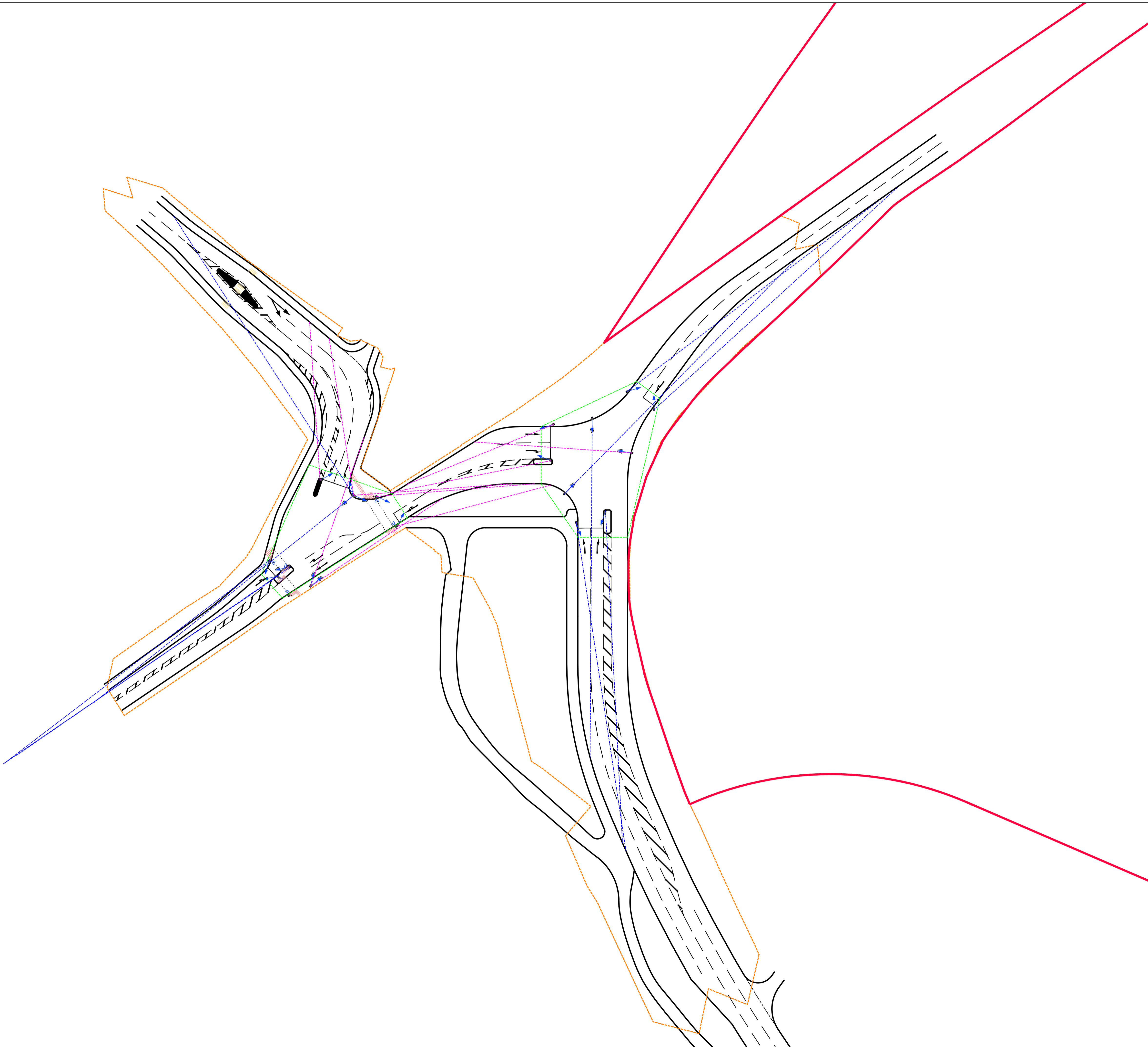
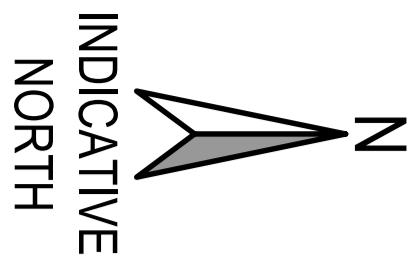

North West Bicester – Hawkwell Village

20300

Appendix G Proposed Signalisation Interim Mitigation Scheme Visibility to Signal Heads



KEY

-  Site Boundary
-  Highway Boundary
-  Forward Visibility (90m)
-  Forward Visibility (43m)

Rev	Date	Description	By	Apvd
P3	24.02.23	Signal Head Amended	JF	AW
P2	17.02.23	Junction Amended	MK	AW
P1	13.02.23	Preliminary issue	MK	AW

Rev Date Description By Apvd

PROJECT:
Bicester

TITLE:
A4095 Signalised Junction Future Scenario Forward Visibility

CLIENT:
Hallam Land Management

SCALE@A1:
1:500

PROJECT REF:
20300

DRAWING No: 040 **REV:** P3

Revision Referencing
P = Preliminary A = Approval T = Tender C = Construction



North West Bicester – Hawkwell Village

20300

Appendix H Proposed Signalisation Interim Mitigation Scheme Signing and Street Lighting Positions

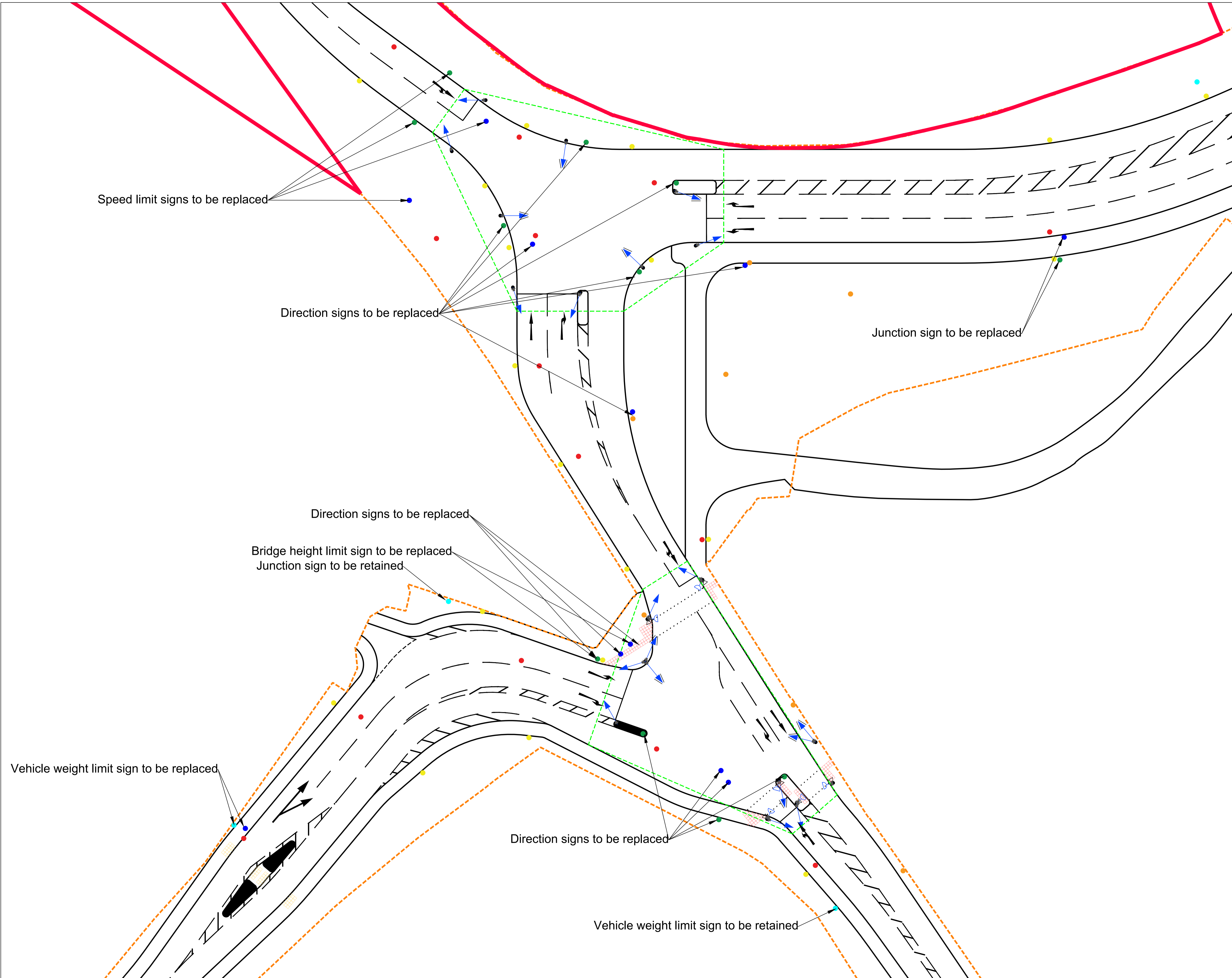

KEY

- Site Boundary
- Highway Boundary
- Removed Lamp Post
- Retained Lamp Post
- Proposed Lamp Post
- Removed Sign Post
- Retained Sign Post
- Proposed Sign Post

Rev	Date	Description	By	Apvd
P3	24.02.23	Amendments	JF	AW
P2	17.02.23	Amendments	MK	AW
P1	13.01.23	Preliminary issue	MK	AW

PROJECT:
BICESTER

TITLE:
A4095 INTERIM SIGNALISED JUNCTION
SIGNING AND LIGHTING

CLIENT:
HALLAM LAND MANAGEMENT

SCALE@A1:
1:250

PROJECT REF:
20300
DRAWING No: 042
REV: P3

Revision Referencing
P = Preliminary A = Approval T = Tender C = Construction



North West Bicester – Hawkwell Village

20300

Appendix I LINSIG Output Report – Proposed Interim Junction 2026

Project and User Details

Project:	North West Bicester - Land North East of the Marylebone-Birmingham Railway Line
Title:	A4095 / Bucknell Road
Location:	Bicester, Oxfordshire
Client:	Hallam Land Management Ltd
Additional detail:	Based on Drawing No. 20300-031-P1.
File name:	A4095_Bucknell Road Junction Network (Pre-Link Road Layout)_2023.02.23 LHA Comments.lsg3x
Author:	MD / SR
Company:	Jubb
Address:	Suite B, Ground Floor West, St James Court, St James Parade, Bristol, BS1 3LH
Linsig Version:	3, 2, 40, 0

Network Layout Diagram

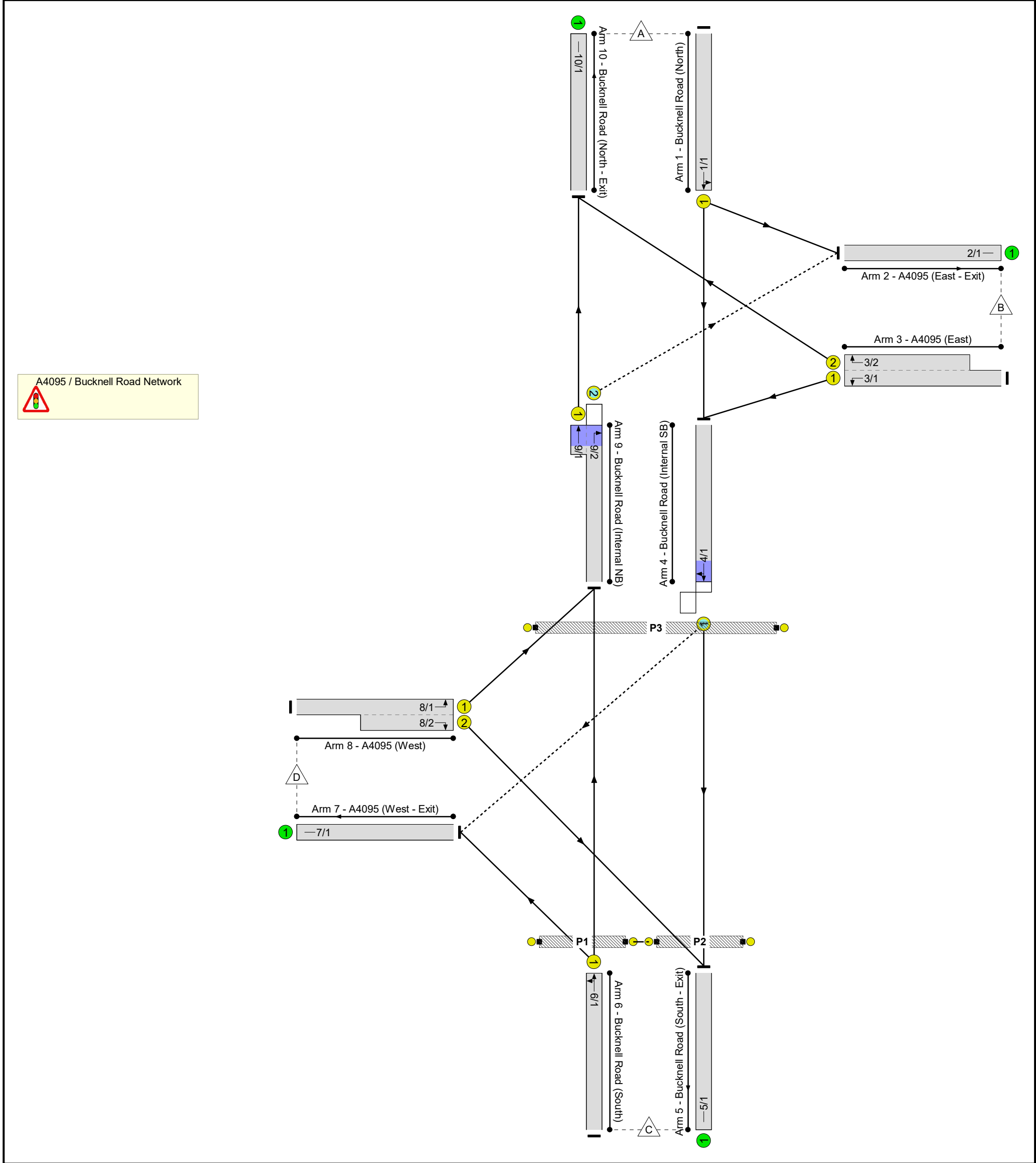

Phase Input Data

Phase Name	Phase Type	Stage Stream	Assoc. Phase	Street Min	Cont Min
A	Traffic	1		7	7
B	Traffic	1		7	7
C	Traffic	1		7	7
D	Traffic	2		7	7
E	Traffic	2		7	7
F	Traffic	2		7	7
G	Traffic	2		7	7
H	Traffic	1		7	7
I	Traffic	1		7	7
J	Pedestrian	2		5	5
K	Pedestrian	2		5	5
L	Pedestrian	2		5	5

Phase Diagram

A



B



C

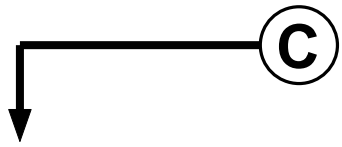

H



I



D

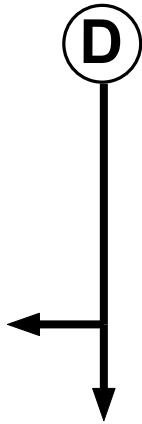

L



F



G

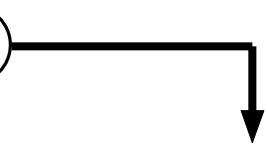

Phase Intergrens Matrix

		Starting Phase											
		A	B	C	D	E	F	G	H	I	J	K	L
Terminating Phase	A		5	6	-	-	-	-	-	-	-	-	-
	B	5		-	-	-	-	-	5	5	-	-	-
	C	5	-		-	-	-	-	-	-	-	-	-
	D	-	-	-		-	-	5	-	-	8	-	5
	E	-	-	-	-		5	5	-	-	-	5	8
	F	-	-	-	-	6		-	-	-	-	-	7
	G	-	-	-	5	7	-		-	-	8	-	-
	H	-	5	-	-	-	-	-		-	-	-	-
	I	-	5	-	-	-	-	-	-		-	-	-
	J	-	-	-	6	-	-	6	-	-		-	-
	K	-	-	-	-	6	-	-	-	-	-		-
	L	-	-	-	10	10	10	-	-	-	-	-	

Phase Delays

Stage Stream: 1

Term. Stage	Start Stage	Phase	Type	Value	Cont value
There are no Phase Delays defined					

Stage Stream: 2

Term. Stage	Start Stage	Phase	Type	Value	Cont value
There are no Phase Delays defined					

Phases in Stage

Stream	Stage No.	Phases in Stage
1	1	C H I
1	2	A H I
1	3	H I
1	4	B
2	1	D F
2	2	D E
2	3	G K L
2	4	F J

Stage Diagram

Stage Stream: 1

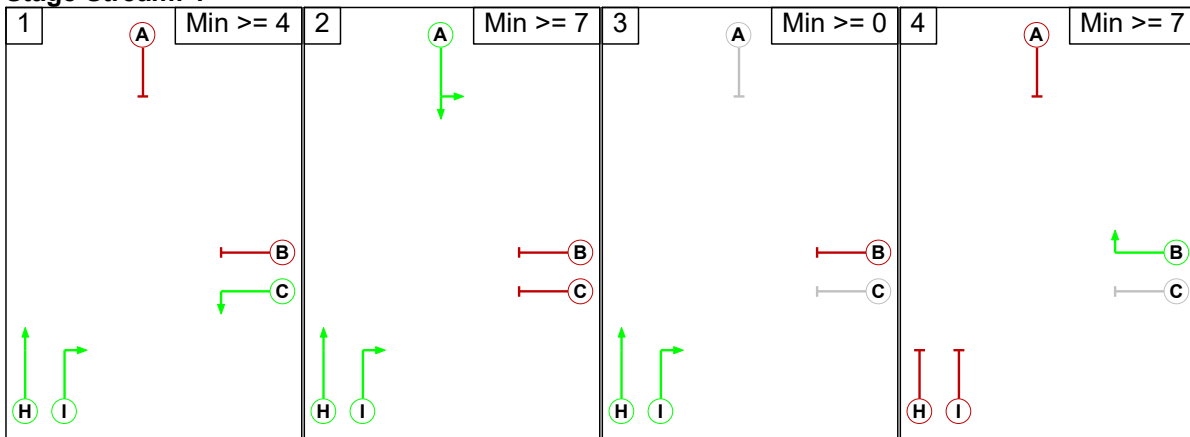

Stage Stream: 2

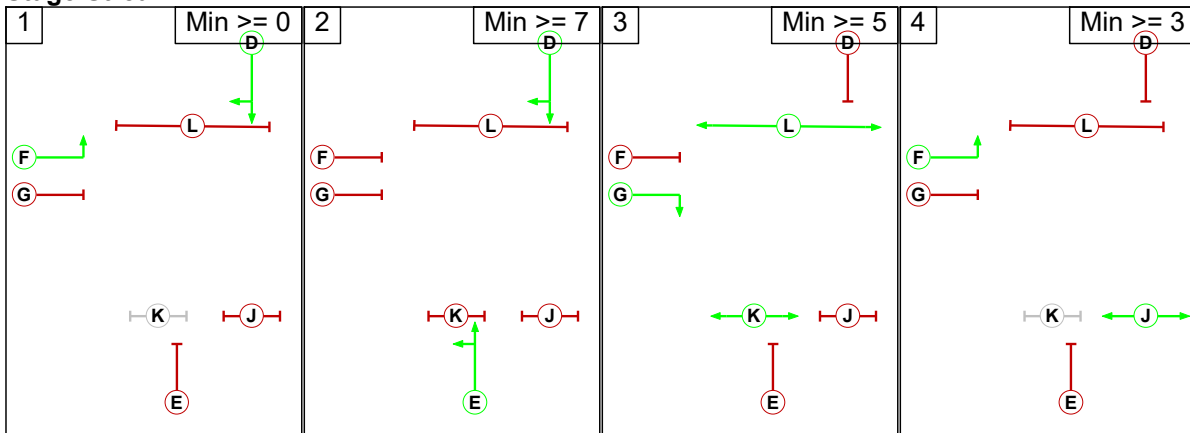

Lane Input Data

Junction: A4095 / Bucknell Road Network												
Lane	Lane Type	Phases	Start Disp.	End Disp.	Physical Length (PCU)	Sat Flow Type	Def User Saturation Flow (PCU/Hr)	Lane Width (m)	Gradient	Nearside Lane	Turns	Turning Radius (m)
1/1 (Bucknell Road (North))	U	A	2	3	60.0	Geom	-	3.80	0.00	Y	Arm 2 Left	35.00
											Arm 4 Ahead	29.00
2/1 (A4095 (East - Exit))	U		2	3	60.0	Inf	-	-	-	-	-	-
3/1 (A4095 (East))	U	C	2	3	60.0	Geom	-	3.50	0.00	Y	Arm 4 Left	12.00
3/2 (A4095 (East))	U	B	2	3	22.3	Geom	-	3.50	0.00	Y	Arm 10 Right	37.00
4/1 (Bucknell Road (Internal SB))	O	D	2	3	8.0	Geom	-	3.00	0.00	Y	Arm 5 Ahead	Inf
											Arm 7 Right	10.00
5/1 (Bucknell Road (South - Exit))	U		2	3	60.0	Inf	-	-	-	-	-	-
6/1 (Bucknell Road (South))	U	E	2	3	60.0	Geom	-	3.20	0.00	Y	Arm 7 Left	30.00
											Arm 9 Ahead	Inf
7/1 (A4095 (West - Exit))	U		2	3	60.0	Inf	-	-	-	-	-	-
8/1 (A4095 (West))	U	F	2	3	60.0	Geom	-	3.75	0.00	Y	Arm 9 Left	7.00
8/2 (A4095 (West))	U	G	2	3	8.9	Geom	-	3.20	0.00	Y	Arm 5 Right	25.00
9/1 (Bucknell Road (Internal NB))	U	H	2	3	2.8	Geom	-	4.40	0.00	Y	Arm 10 Ahead	27.00
9/2 (Bucknell Road (Internal NB))	O	I	2	3	8.2	Geom	-	4.40	0.00	Y	Arm 2 Right	14.00
10/1 (Bucknell Road (North - Exit))	U		2	3	60.0	Inf	-	-	-	-	-	-

Give-Way Lane Input Data

Junction: A4095 / Bucknell Road Network												
Lane	Movement	Max Flow when Giving Way (PCU/Hr)	Min Flow when Giving Way (PCU/Hr)	Opposing Lane	Opp. Lane Coeff.	Opp. Mvmnts.	Right Turn Storage (PCU)	Non-Blocking Storage (PCU)	RTF	Right Turn Move up (s)	Max Turns in Intergreen (PCU)	
4/1 (Bucknell Road (Internal SB))	7/1 (Right)	1439	0	6/1	1.09	All	3.00	2.00	0.50	3	3.00	
9/2 (Bucknell Road (Internal NB))	2/1 (Right)	1439	0	1/1	1.09	All	2.00	-	0.50	2	2.00	

Traffic Flow Groups

Flow Group	Start Time	End Time	Duration	Formula
1: 'Strategic Model Hawkfield 2026 Development 1a - AM'	08:00	09:00	01:00	
2: 'Strategic Model Hawkfield 2026 Development 1a - PM'	17:00	18:00	01:00	
3: 'Strategic Model Hawkfield 2026 Development 2a - AM'	08:00	09:00	01:00	
4: 'Strategic Model Hawkfield 2026 Development 2a - PM'	17:00	18:00	01:00	

Traffic Flows, Desired

FG1: 'Strategic Model Hawkfield 2026 Development 1a - AM'

Desired Flow :

Origin	Destination					Tot.
	A	B	C	D		
A	0	163	13	55	231	
B	144	0	139	580	863	
C	56	236	0	325	617	
D	91	379	13	0	483	
Tot.	291	778	165	960	2194	

FG2: 'Strategic Model Hawkfield 2026 Development 1a - PM'

Desired Flow :

		Destination					Tot.
		A	B	C	D		
Origin	A	0	154	26	53	233	
	B	84	0	261	544	889	
	C	43	283	0	230	556	
	D	96	630	17	0	743	
	Tot.	223	1067	304	827	2421	

FG3: 'Strategic Model Hawkfield 2026 Development 2a - AM'

Desired Flow :

		Destination					Tot.
		A	B	C	D		
Origin	A	0	161	13	52	226	
	B	152	0	149	582	883	
	C	56	236	0	326	618	
	D	90	378	13	0	481	
	Tot.	298	775	175	960	2208	

FG4: 'Strategic Model Hawkfield 2026 Development 2a - PM'

Desired Flow :

		Destination					Tot.
		A	B	C	D		
Origin	A	0	164	29	63	256	
	B	85	0	252	544	881	
	C	43	293	0	192	528	
	D	92	636	15	0	743	
	Tot.	220	1093	296	799	2408	

Scenario 1: 'Strategic Model Hawkfield Development 1a - AM' (FG1: 'Strategic Model Hawkfield 2026 Development 1a - AM', Plan 1: 'Network Control Plan 1')

Signal Timings Diagram

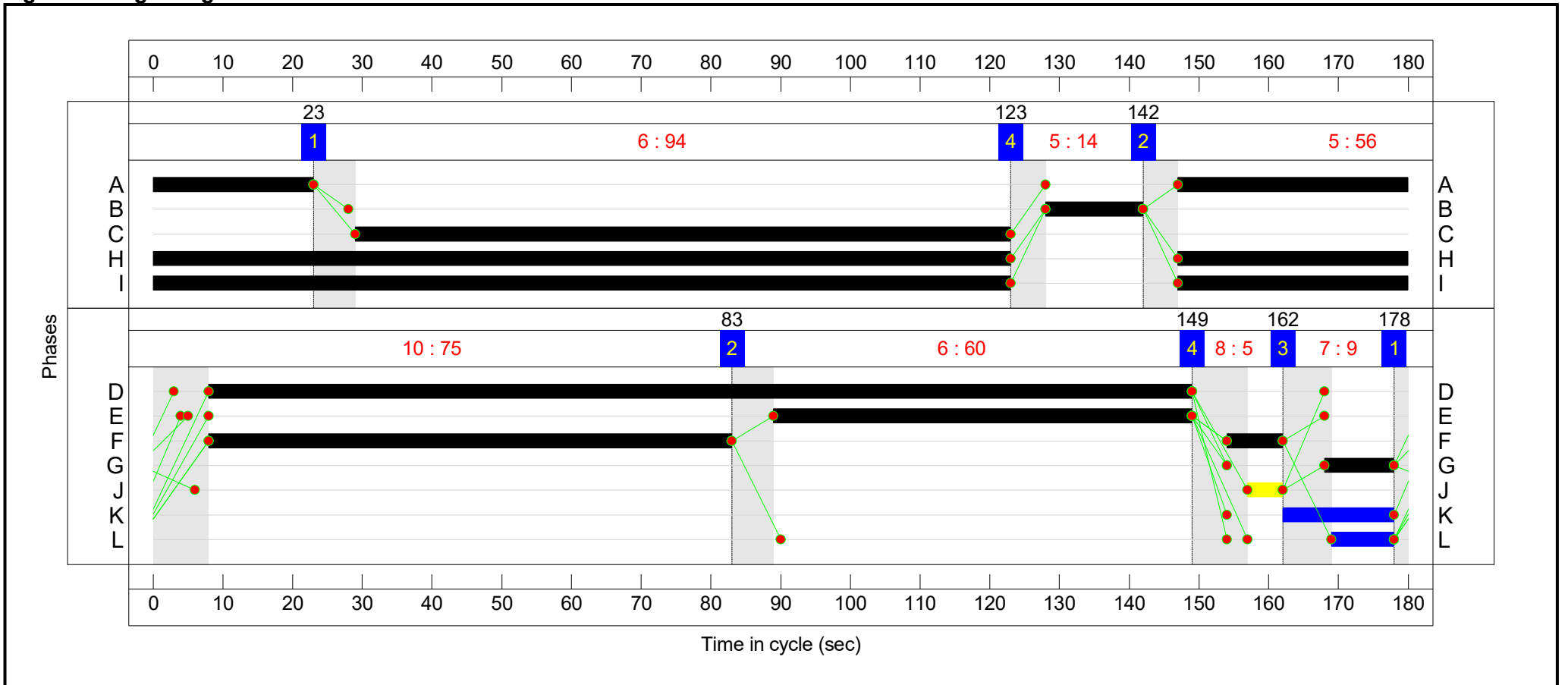

Network Results

Item	Lane Description	Lane Type	Full Phase	Arrow Phase	Demand Flow (pcu)	Sat Flow (pcu/Hr)	Deg Sat (%)	Av. Delay Per PCU (s/pcu)	Mean Max Queue (pcu)	Item
Network: A4095 / Bucknell Road	-	-	-		-	-	97.4%	-	-	Network: A4095 / Bucknell Road
A4095 / Bucknell Road Network	-	-	-		-	-	97.4%	-	-	A4095 / Bucknell Road Network
1/1	Bucknell Road (North) Left Ahead	U	A		231	1908	38.2%	52.6	9.2	1/1
2/1	A4095 (East - Exit)	U	-		778	Inf	0.0%	0.0	0.0	2/1
3/1+3/2	A4095 (East) Left Right	U	C B		863	1747:1888	84.3 : 91.5%	53.9 (46.0:93.6)	33.7	3/1+3/2
4/1	Bucknell Road (Internal SB) Ahead Right	O	D		787	1708	97.4%	27.7	12.1	4/1
5/1	Bucknell Road (South - Exit)	U	-		165	Inf	0.0%	0.0	0.0	5/1
6/1	Bucknell Road (South) Left Ahead	U	E		617	1885	96.6%	105.8	38.3	6/1
7/1	A4095 (West - Exit)	U	-		960	Inf	0.0%	0.0	0.0	7/1
8/1+8/2	A4095 (West) Right Left	U	F G		483	1639:1825	61.3 : 61.3%	38.0 (36.7:87.7)	14.1	8/1+8/2
9/2+9/1	Bucknell Road (Internal NB) Right Ahead	O+U	I H		762	1856:1947	52.8 : 52.8%	8.8 (9.8:4.9)	11.6	9/2+9/1
10/1	Bucknell Road (North - Exit)	U	-		291	Inf	0.0%	0.0	0.0	10/1
Ped Link: P1	Pedestrians Crossing Bucknell Road Northbound	-	K		0	-	0.0%	-	-	Ped Link: P1
Ped Link: P2	Pedestrians Crossing Bucknell Road Southbound	-	J		0	-	0.0%	-	-	Ped Link: P2
Ped Link: P3	Unnamed Ped Link	-	L		0	-	0.0%	-	-	Ped Link: P3
C1 Stream: 1 PRC for Signalled Lanes (%):		-1.7	Total Delay for Signalled Lanes (pcuHr):		18.18	Cycle Time (s):		180		
C1 Stream: 2 PRC for Signalled Lanes (%):		-8.2	Total Delay for Signalled Lanes (pcuHr):		29.28	Cycle Time (s):		180		
PRC Over All Lanes (%):		-8.2	Total Delay Over All Lanes(pcuHr):		47.46					

Scenario 2: 'Strategic Model Hawkfield Development 1a - PM' (FG2: 'Strategic Model Hawkfield 2026 Development 1a - PM', Plan 1: 'Network Control Plan 1')

Signal Timings Diagram

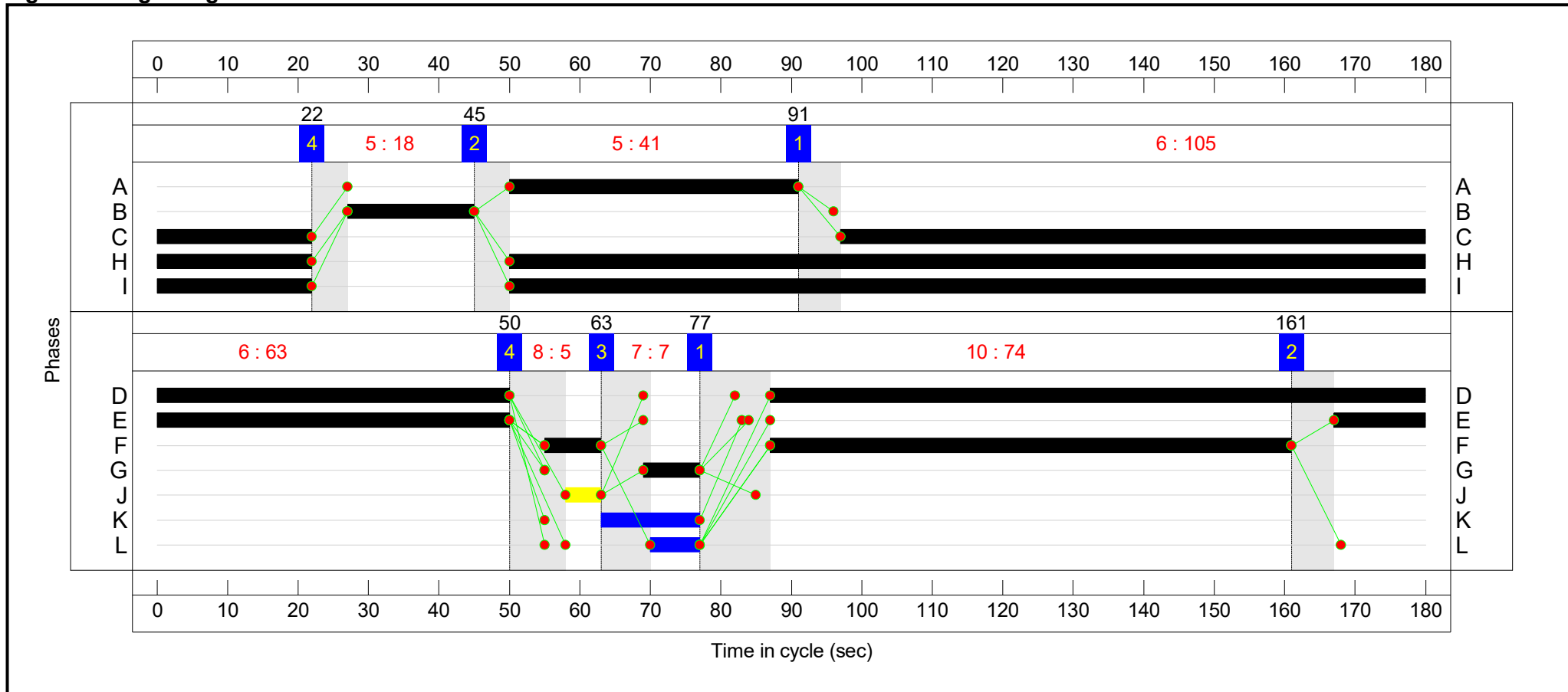

Network Results

Item	Lane Description	Lane Type	Full Phase	Arrow Phase	Demand Flow (pcu)	Sat Flow (pcu/Hr)	Deg Sat (%)	Av. Delay Per PCU (s/pcu)	Mean Max Queue (pcu)	Item
Network: A4095 / Bucknell Road	-	-	-		-	-	97.3%	-	-	Network: A4095 / Bucknell Road
A4095 / Bucknell Road Network	-	-	-		-	-	97.3%	-	-	A4095 / Bucknell Road Network
1/1	Bucknell Road (North) Left Ahead	U	A		233	1908	52.3%	68.7	10.7	1/1
2/1	A4095 (East - Exit)	U	-		1067	Inf	0.0%	0.0	0.0	2/1
3/1+3/2	A4095 (East) Left Right	U	C B		889	1747:1888	81.9 : 81.9%	41.7 (37.2:84.3)	34.4	3/1+3/2
4/1	Bucknell Road (Internal SB) Ahead Right	O	D		884	1739	97.3%	14.3	7.5	4/1
5/1	Bucknell Road (South - Exit)	U	-		304	Inf	0.0%	0.0	0.0	5/1
6/1	Bucknell Road (South) Left Ahead	U	E		556	1896	82.5%	67.6	27.6	6/1
7/1	A4095 (West - Exit)	U	-		827	Inf	0.0%	0.0	0.0	7/1
8/1+8/2	A4095 (West) Right Left	U	F G		743	1639:1825	95.5 : 95.5%	81.3 (79.4:158.7)	38.5	8/1+8/2
9/2+9/1	Bucknell Road (Internal NB) Right Ahead	O+U	I H		1052	1856:1947	75.6 : 75.6%	8.4 (8.9:5.1)	11.6	9/2+9/1
10/1	Bucknell Road (North - Exit)	U	-		223	Inf	0.0%	0.0	0.0	10/1
Ped Link: P1	Pedestrians Crossing Bucknell Road Northbound	-	K		0	-	0.0%	-	-	Ped Link: P1
Ped Link: P2	Pedestrians Crossing Bucknell Road Southbound	-	J		0	-	0.0%	-	-	Ped Link: P2
Ped Link: P3	Unnamed Ped Link	-	L		0	-	0.0%	-	-	Ped Link: P3
C1 Stream: 1 PRC for Signalled Lanes (%):		9.9	Total Delay for Signalled Lanes (pcuHr):		17.20	Cycle Time (s):		180		
C1 Stream: 2 PRC for Signalled Lanes (%):		-8.1	Total Delay for Signalled Lanes (pcuHr):		30.72	Cycle Time (s):		180		
PRC Over All Lanes (%):		-8.1	Total Delay Over All Lanes(pcuHr):		47.91					

Scenario 3: 'Strategic Model Hawkfield Development 2a - AM' (FG3: 'Strategic Model Hawkfield 2026 Development 2a - AM', Plan 1: 'Network Control Plan 1')

Signal Timings Diagram

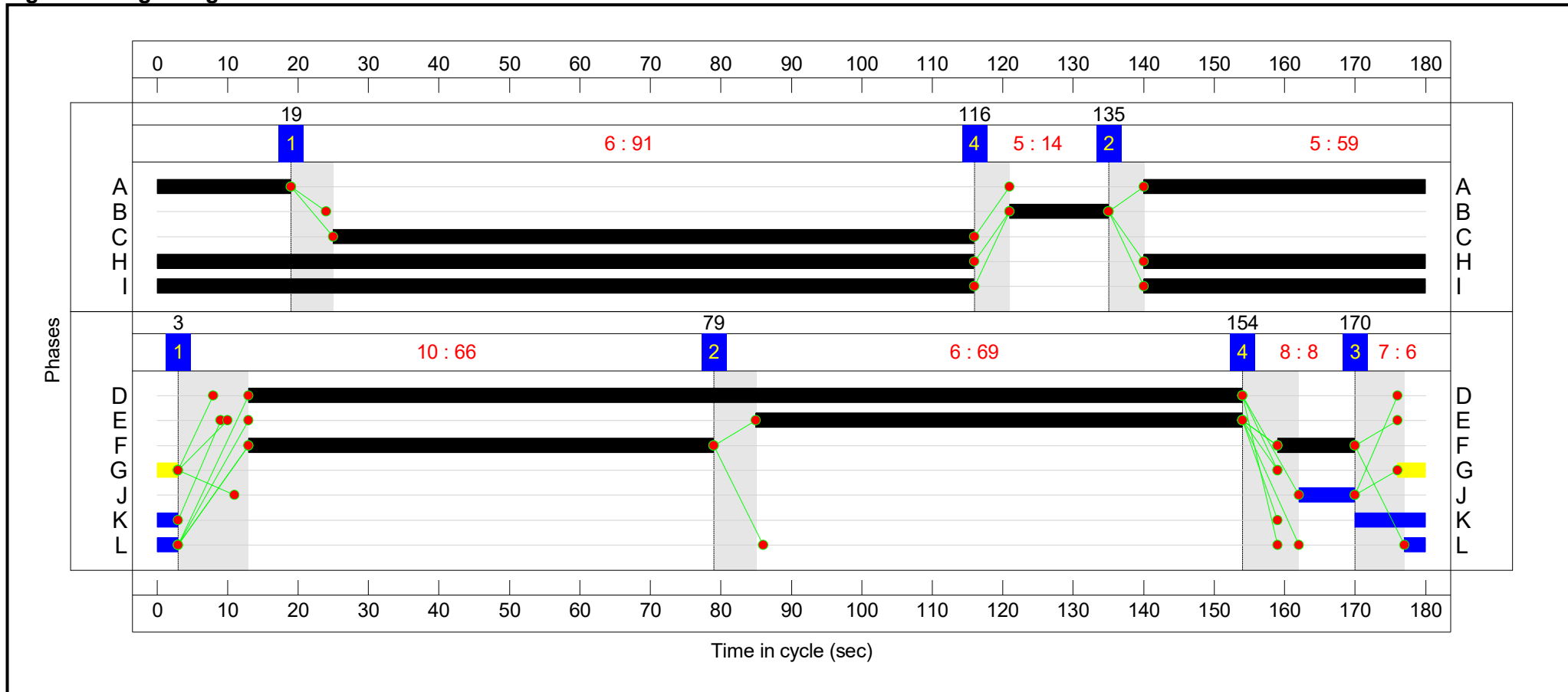

Network Results

Item	Lane Description	Lane Type	Full Phase	Arrow Phase	Demand Flow (pcu)	Sat Flow (pcu/Hr)	Deg Sat (%)	Av. Delay Per PCU (s/pcu)	Mean Max Queue (pcu)	Item
Network: A4095 / Bucknell Road	-	-	-		-	-	99.5%	-	-	Network: A4095 / Bucknell Road
A4095 / Bucknell Road Network	-	-	-		-	-	99.5%	-	-	A4095 / Bucknell Road Network
1/1	Bucknell Road (North) Left Ahead	U	A		226	1908	35.5%	49.8	8.8	1/1
2/1	A4095 (East - Exit)	U	-		775	Inf	0.0%	0.0	0.0	2/1
3/1+3/2	A4095 (East) Left Right	U	C B		883	1747:1888	88.5 : 96.6%	61.6 (53.8:98.8)	37.7	3/1+3/2
4/1	Bucknell Road (Internal SB) Ahead Right	O	D		796	1711	99.5%	26.1	10.3	4/1
5/1	Bucknell Road (South - Exit)	U	-		175	Inf	0.0%	0.0	0.0	5/1
6/1	Bucknell Road (South) Left Ahead	U	E		618	1885	84.3%	65.0	30.6	6/1
7/1	A4095 (West - Exit)	U	-		960	Inf	0.0%	0.0	0.0	7/1
8/1+8/2	A4095 (West) Right Left	U	F G		481	1639:1825	65.5 : 65.5%	43.2 (41.6:100.0)	14.2	8/1+8/2
9/2+9/1	Bucknell Road (Internal NB) Right Ahead	O+U	I H		760	1856:1947	52.6 : 52.6%	8.1 (9.1:3.9)	11.6	9/2+9/1
10/1	Bucknell Road (North - Exit)	U	-		298	Inf	0.0%	0.0	0.0	10/1
Ped Link: P1	Pedestrians Crossing Bucknell Road Northbound	-	K		0	-	0.0%	-	-	Ped Link: P1
Ped Link: P2	Pedestrians Crossing Bucknell Road Southbound	-	J		0	-	0.0%	-	-	Ped Link: P2
Ped Link: P3	Unnamed Ped Link	-	L		0	-	0.0%	-	-	Ped Link: P3
C1 Stream: 1 PRC for Signalled Lanes (%):		-7.3	Total Delay for Signalled Lanes (pcuHr):		19.94	Cycle Time (s):		180		
C1 Stream: 2 PRC for Signalled Lanes (%):		-10.5	Total Delay for Signalled Lanes (pcuHr):		22.70	Cycle Time (s):		180		
PRC Over All Lanes (%):		-10.5	Total Delay Over All Lanes(pcuHr):		42.63					

Scenario 4: 'Strategic Model Hawkfield Development 2a - PM' (FG4: 'Strategic Model Hawkfield 2026 Development 2a - PM', Plan 1: 'Network Control Plan 1')

Signal Timings Diagram

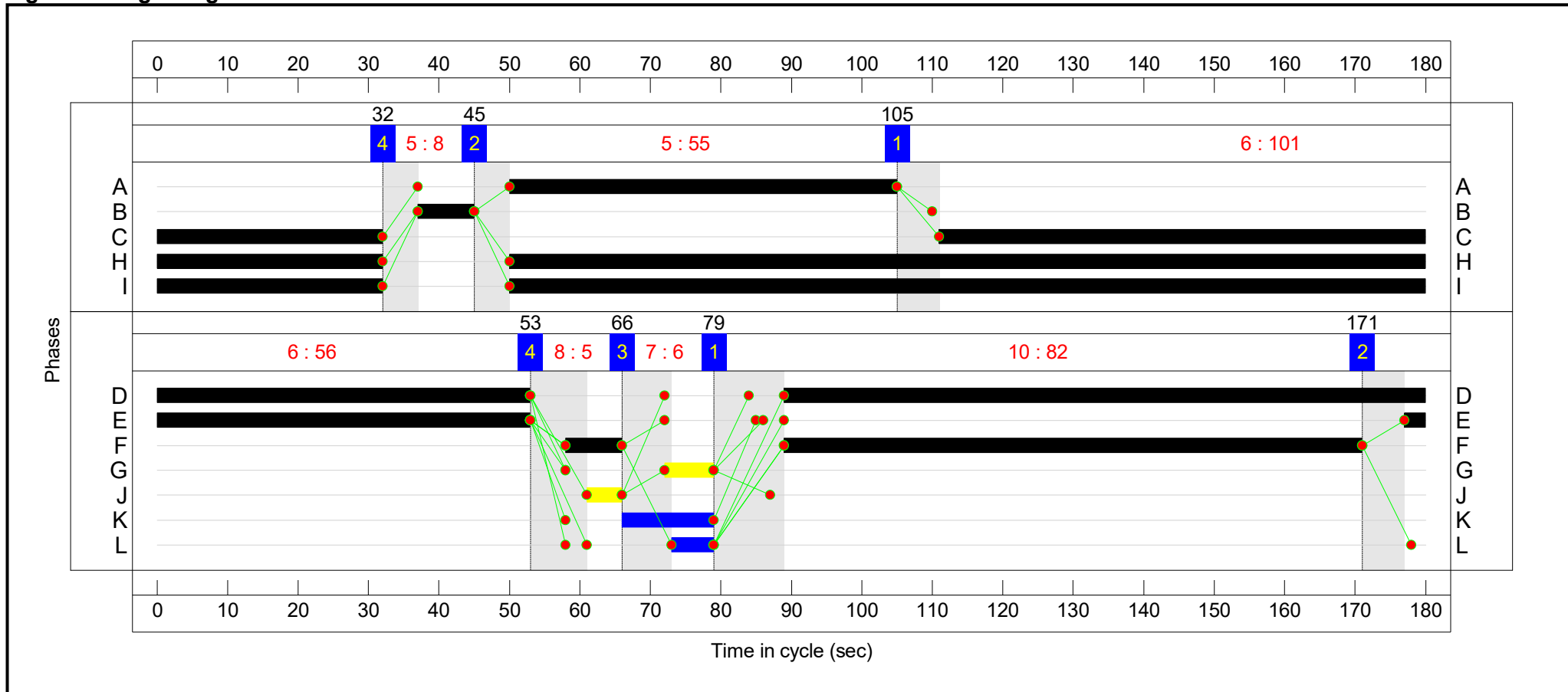

Network Results

Item	Lane Description	Lane Type	Full Phase	Arrow Phase	Demand Flow (pcu)	Sat Flow (pcu/Hr)	Deg Sat (%)	Av. Delay Per PCU (s/pcu)	Mean Max Queue (pcu)	Item
Network: A4095 / Bucknell Road	-	-	-		-	-	94.2%	-	-	Network: A4095 / Bucknell Road
A4095 / Bucknell Road Network	-	-	-		-	-	94.2%	-	-	A4095 / Bucknell Road Network
1/1	Bucknell Road (North) Left Ahead	U	A		256	1907	43.1%	54.7	10.5	1/1
2/1	A4095 (East - Exit)	U	-		1093	Inf	0.0%	0.0	0.0	2/1
3/1+3/2	A4095 (East) Left Right	U	C B		881	1747:1888	84.1 : 90.0%	47.2 (42.0:95.9)	35.8	3/1+3/2
4/1	Bucknell Road (Internal SB) Ahead Right	O	D		888	1737	94.2%	19.5	10.9	4/1
5/1	Bucknell Road (South - Exit)	U	-		296	Inf	0.0%	0.0	0.0	5/1
6/1	Bucknell Road (South) Left Ahead	U	E		528	1900	87.8%	80.6	28.2	6/1
7/1	A4095 (West - Exit)	U	-		799	Inf	0.0%	0.0	0.0	7/1
8/1+8/2	A4095 (West) Right Left	U	F G		743	1639:1825	87.4 : 87.4%	53.7 (52.1:133.6)	31.5	8/1+8/2
9/2+9/1	Bucknell Road (Internal NB) Right Ahead	O+U	I H		1064	1856:1947	73.5 : 73.5%	7.4 (8.0:3.5)	11.4	9/2+9/1
10/1	Bucknell Road (North - Exit)	U	-		220	Inf	0.0%	0.0	0.0	10/1
Ped Link: P1	Pedestrians Crossing Bucknell Road Northbound	-	K		0	-	0.0%	-	-	Ped Link: P1
Ped Link: P2	Pedestrians Crossing Bucknell Road Southbound	-	J		0	-	0.0%	-	-	Ped Link: P2
Ped Link: P3	Unnamed Ped Link	-	L		0	-	0.0%	-	-	Ped Link: P3
C1 Stream: 1 PRC for Signalled Lanes (%):		-0.0	Total Delay for Signalled Lanes (pcuHr):		17.64	Cycle Time (s):		180		
C1 Stream: 2 PRC for Signalled Lanes (%):		-4.6	Total Delay for Signalled Lanes (pcuHr):		27.73	Cycle Time (s):		180		
PRC Over All Lanes (%):		-4.6	Total Delay Over All Lanes(pcuHr):		45.37					

North West Bicester – Hawkwell Village

20300

Appendix J Strategic Link Road (East of the Railway Line) Proposed Scheme

Viewport 1 - Link Road Overview (1:2000)

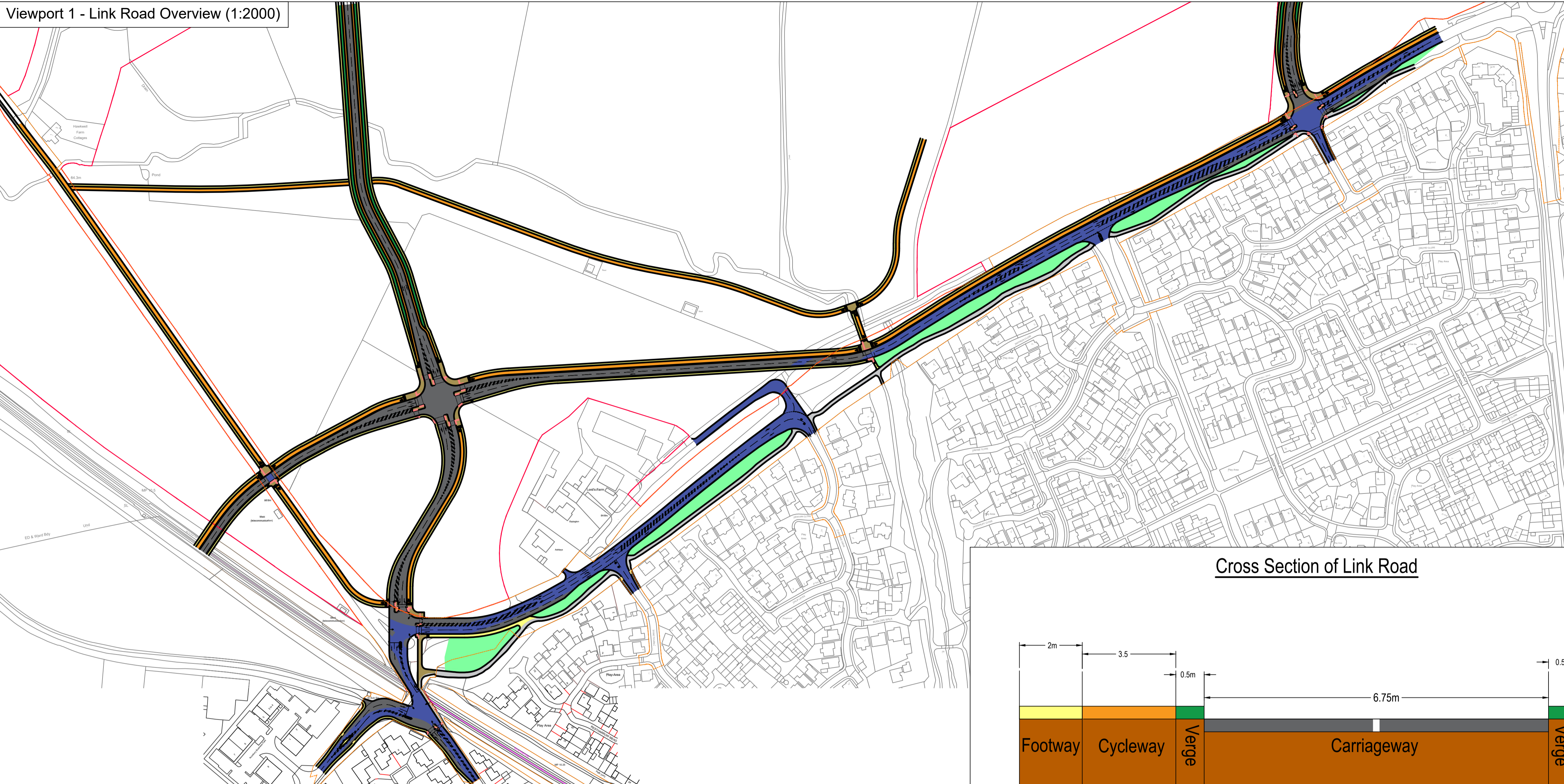

- ### KEY
- Site Boundary
 - Highway Boundary
 - Proposed Carriageway
 - Existing Carriageway
 - Proposed Footpath
 - Proposed Footpath
 - Proposed Verge
 - Existing Verge
 - Proposed Cycle Path
 - Proposed Shared Cycle / Pedestrian Path

Cross Section of Link Road

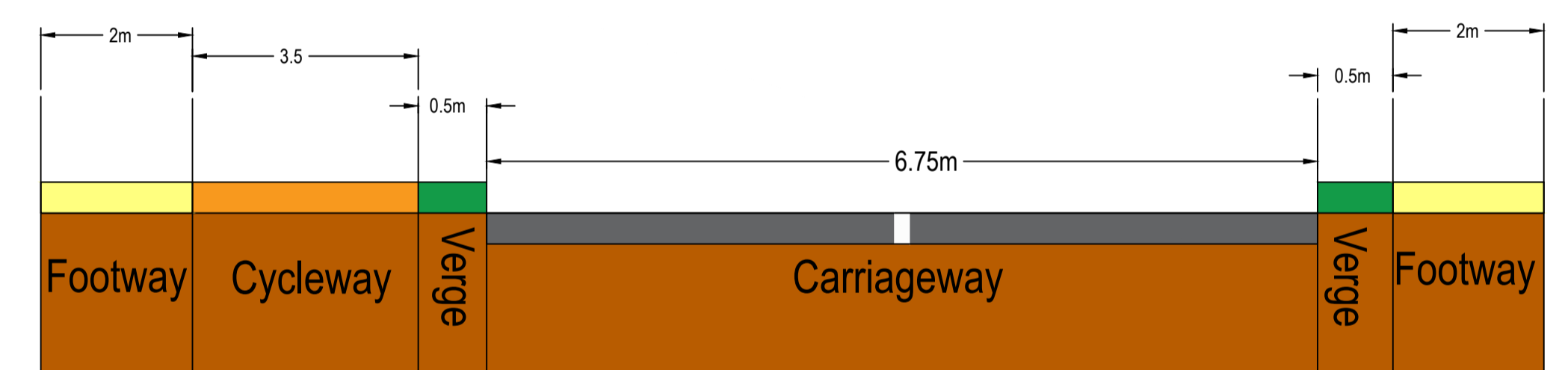

Viewport 2 - Proposed Site Access / Link Road Signalized Junction (1:500)

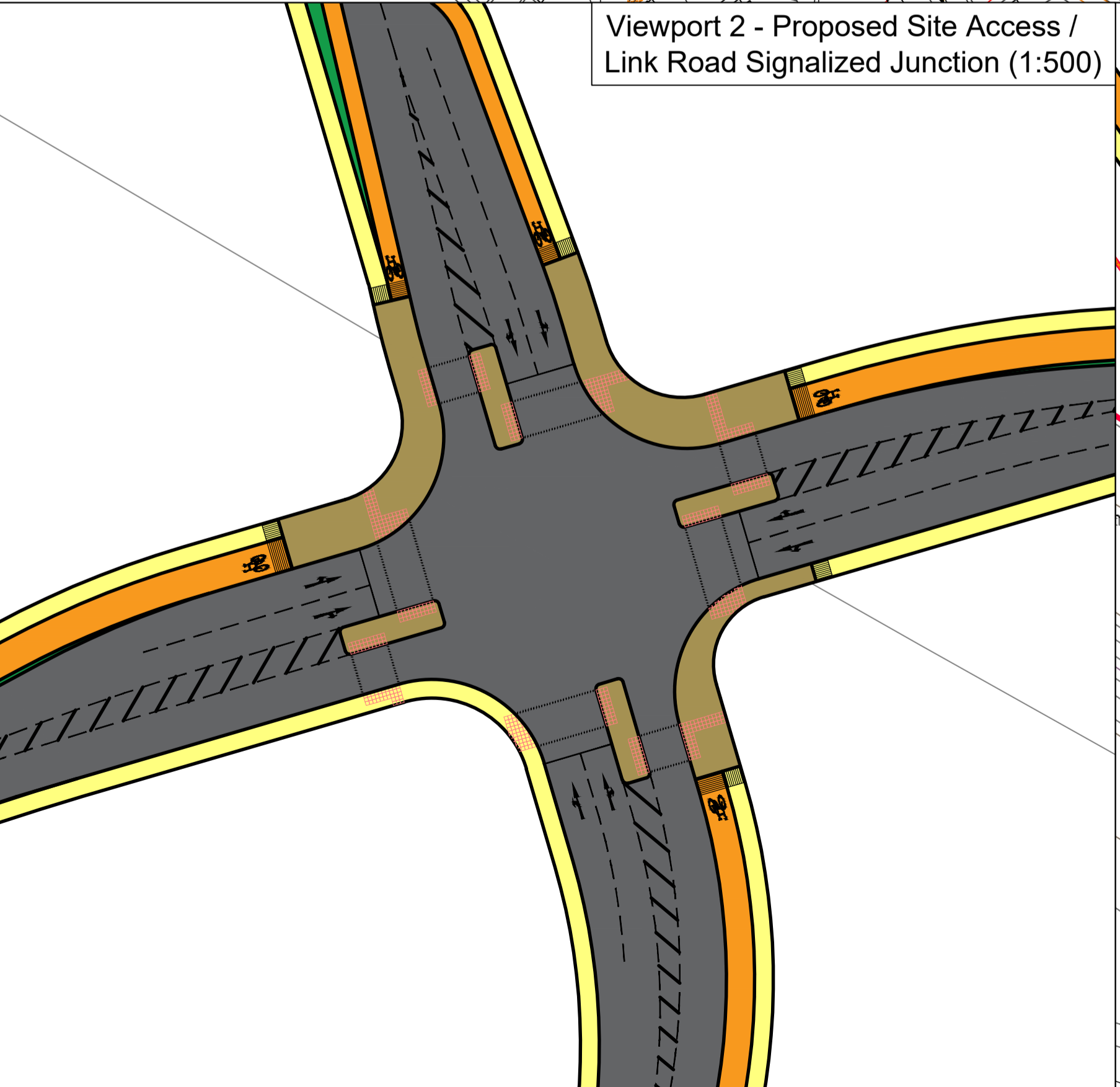

Viewport 2 - Bucknell Road / A0495 Signalized Junction (1:500)

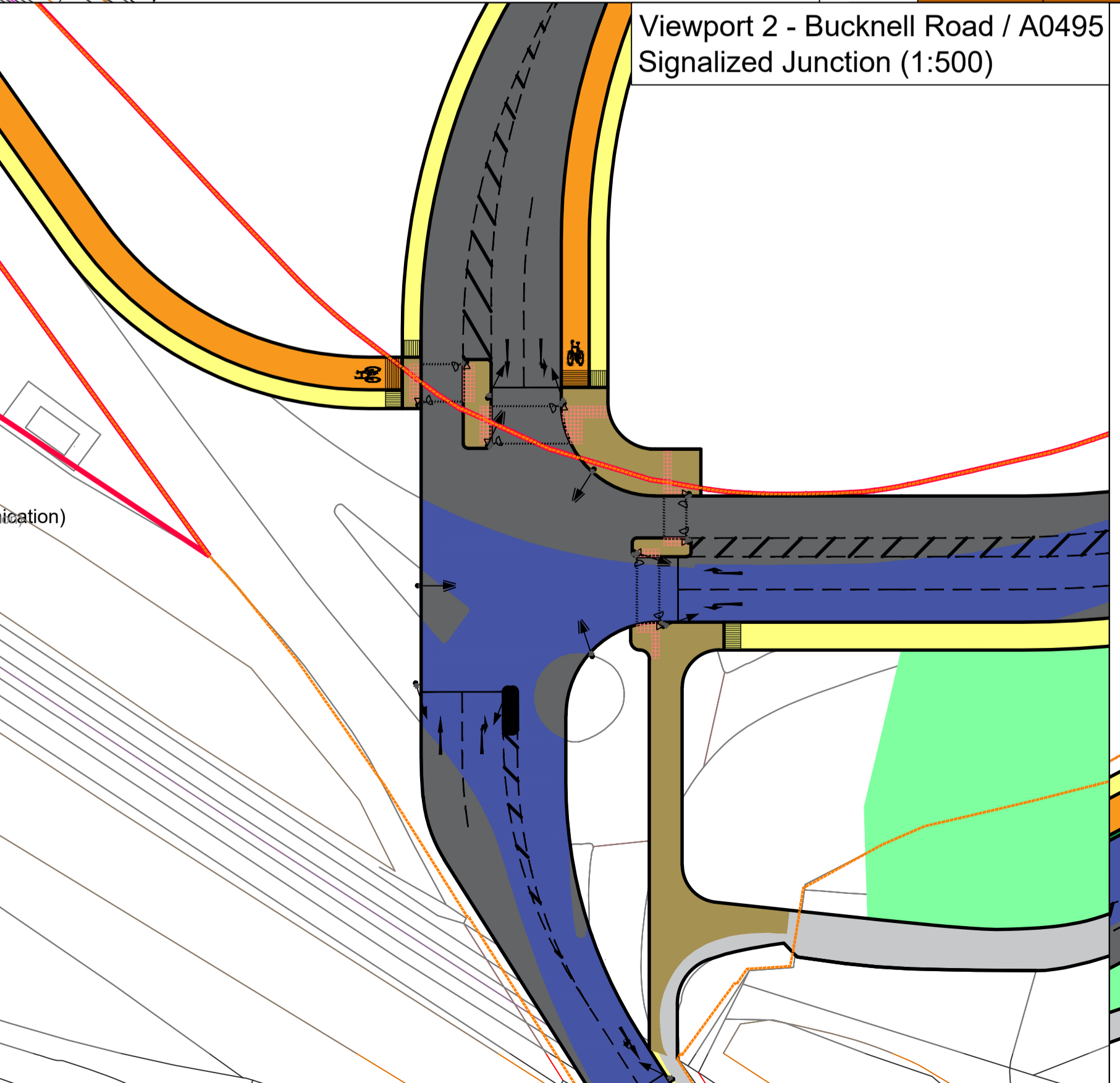

Viewport 3 - Proposed Site Access / Germander Way / A4095 Signalized Junction (1:500)

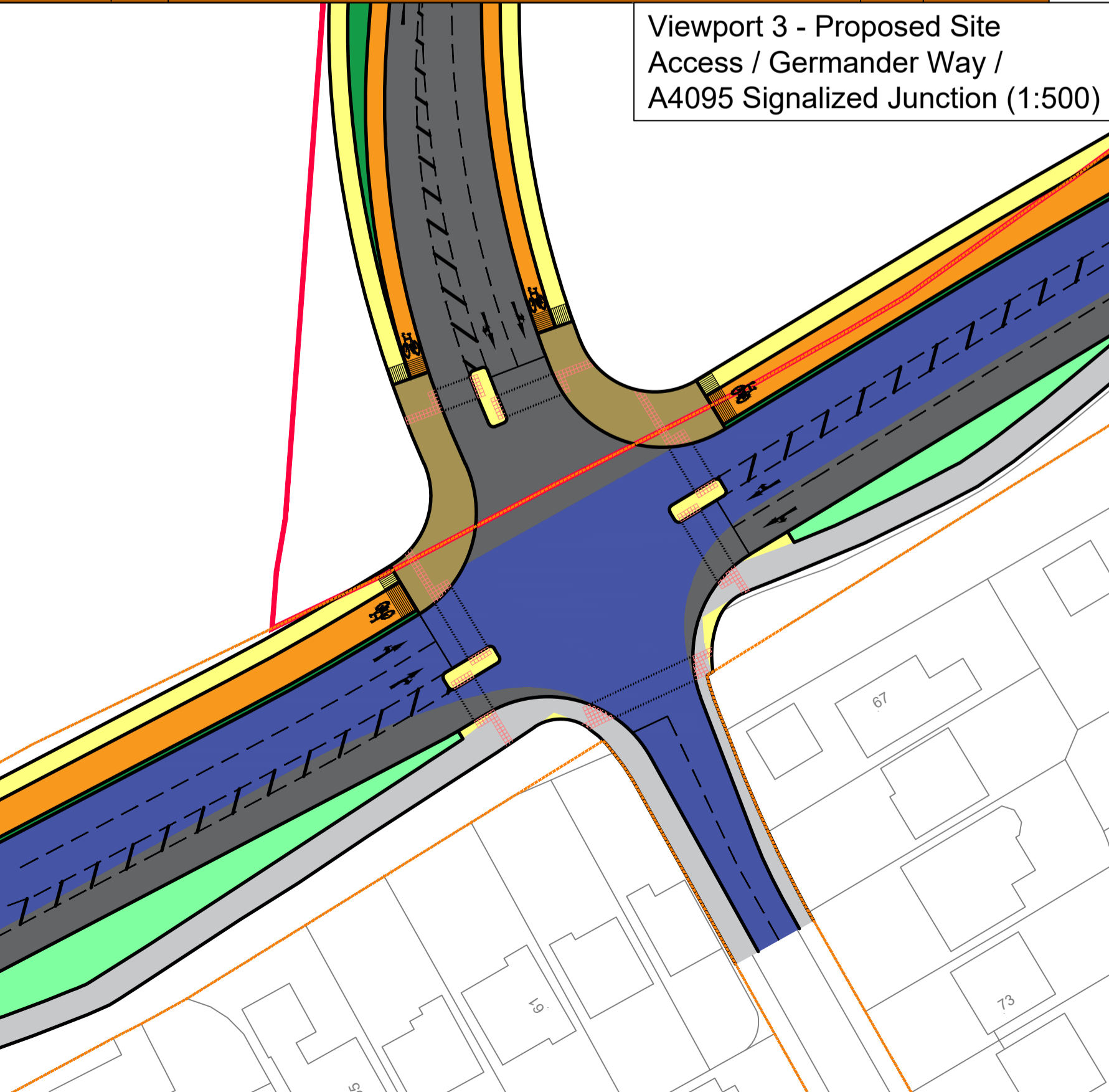

P1	11.01.23	Preliminary issue	MK	AW
Rev	Date	Description	By	Apvd

PROJECT:
BICESTER

TITLE:
EAST SECTION OF THE LINK ROAD

CLIENT:
HALLAM LAND MANAGEMENT

SCALE@A1:
1:2000 / 1:500

PROJECT REF:
20300
DRAWING No: 035
REV: P1

Revision Referencing
P = Preliminary A = Approval T = Tender C = Construction



North West Bicester – Hawkwell Village

20300

Appendix K – Bucknell Road Proposed Traffic Calming Scheme

Indicative location for vehicular access and raised table to cemetery and allotments

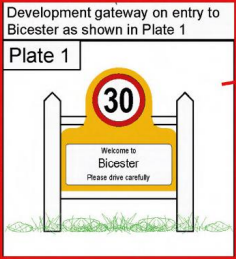

Proposed pedestrian crossing

Speed cushions / priority narrowing @ 90m intervals



Indicative location for vehicular access and raised table to access new housing

Proposed pedestrian crossing

New pedestrian bridge under railway

Access to employment



New road bridge under railway

Toucan crossing



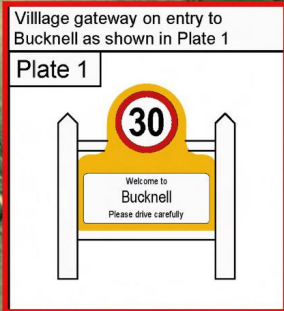

Existing priority road narrowing

Proposed raised table traffic calming

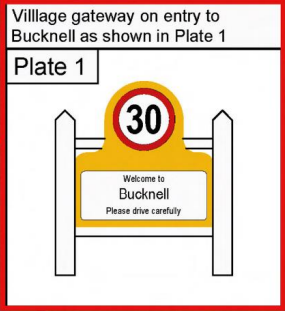

Existing road humps to be resurfaced and repainted.

Existing priority road narrowing

Priority speed cushions / priority narrowing @ 90m intervals

