



Road Layout
Design

CD 123

Geometric design of at-grade priority and signal-controlled junctions

(formerly TD 41/95, TD 42/95, TD 40/94, and those parts of TD 50/04 and TD 70/08 relating to priority and signal-controlled junctions.)

Version 2.1.0

Summary

This document provides requirements for the geometric design of at-grade priority and signal-controlled junctions.

Application by Overseeing Organisations

Any specific requirements for Overseeing Organisations alternative or supplementary to those given in this document are given in National Application Annexes to this document.

Feedback and Enquiries

Users of this document are encouraged to raise any enquiries and/or provide feedback on the content and usage of this document to the dedicated National Highways team. The email address for all enquiries and feedback is: Standards_Enquiries@highwaysengland.co.uk

This is a controlled document.

Contents

Release notes	3
Foreword	4
Publishing information	4
Contractual and legal considerations	4
Introduction	5
Background	5
Assumptions made in the preparation of this document	5
Abbreviations	6
Terms and definitions	7
1. Scope	10
Aspects covered	10
Implementation	10
Use of GG 101	10
2. Junction selection	11
Priority junction selection	11
WS2+1 roads	12
Dual carriageway roads	14
Major road central treatment selection	15
Ghost island central treatment	15
Single lane dualling (SLD) central treatment	16
Permitted movements at SLD and dual-carriageway priority junctions	16
Crossroads and staggered junctions	17
Signal-controlled junctions	19
Direct accesses	19
3. Visibility	20
Minor road approach visibility	20
Priority junctions	20
Direct accesses	21
Junction visibility	22
Measurement of visibility at minor roads and direct accesses	22
Measurement of visibility in the central reserve	25
4. Geometric design of direct accesses	27
5. Geometric design of priority junctions	29
General	29
Corner radii and corner radii tapers	29
Carriageway widths	31
Minor road traffic islands	33
Diverge tapers and auxiliary lanes	34
General	34
Diverge taper and auxiliary lane widths and lengths	35
Merging tapers	36
General	36
Merging tapers widths and length	36

6. Geometric design of major road central treatments	38
General	38
Major road central treatment formation excluding on WS2+1 roads	38
Major road central treatment formation on WS2+1 roads	38
Major road central treatment right turning lane length	40
Ghost islands	43
Through lane widths	43
Island and right turning lane widths on WS2+1 roads	44
Island and right turning lane widths on all roads except WS2+1	44
SLD and dual carriageway	45
Through lane widths	45
Island and right turning lane dimensions	45
Physical central reserve layout on WS2+1	48
Through lane widths	48
Central island layout	48
Passing bays	49
7. Geometric design of signal-controlled junctions	51
Junction intersection	51
Visibility at signal-controlled junctions	51
Visibility of signals	51
Junction intervisibility zone	53
Entry lanes, exit lanes and storage capacity	54
Lane widths	54
Storage length	55
Exit lane continuity	55
Other geometrical elements of signal-controlled junctions	56
Swept path and corner radii	56
Traffic islands (including at left-turn slips)	57
Right-turning traffic movements	58
Location of controller cabinets	60
8. Normative references	61
9. Informative references	62
Appendix A. Examples of signal-controlled junction layouts and impact on signal operation	63
A1 Opposing right turns at signal-controlled junctions	63
A2 Signal-controlled T-junctions	63
A2.1 Small urban signal controlled T-junction	63
A2.2 Large urban or larger rural signal-controlled T-junction	63
A3 Signal-controlled crossroads	64
A3.1 Urban signal-controlled crossroads	64
A3.2 Complex urban / rural signal-controlled crossroads	65
A4 Signal-controlled staggered junctions	66
A4.1 Operation of signal-controlled staggered junctions	66
A4.2 Left/right staggers	67
A4.3 Right/left staggers	68
A5 Signal-controlled skew junctions	70
A6 Signal-controlled junctions on one-way roads	71
A7 Signal-controlled junctions with more than four arms	72

Latest release notes

Document code	Version number	Date of publication of relevant change	Changes made to	Type of change
CD 123	2.1.0	November 2021	Core document	Incremental change to requirements

Revision 2.1.0 – the scope of use for direct accesses has been expanded to include single use public utilities site and single use highway maintenance site; the definition of a through-route now includes 'for public use'; new geometrical parameters for such junctions where right turns out of the minor road are prevented have been included; the minimum spacing distance between the end of dual carriageway to a priority junction has been reduced from 1km to 500 metres (para 2.11); the way that traditional relaxation clauses are presented has been updated to be clearer; plus various wording improvement/corrections.

Previous versions

Document code	Version number	Date of publication of relevant change	Changes made to	Type of change
CD 123	2	August 2020		
CD 123	1	June 2020		
CD 123	1	January 2020		
CD 123	0	August 2019		

Foreword

Publishing information

This document is published by National Highways.

This document supersedes TD 41/95 and TD 42/95. In combination with CD 122 [Ref 4.N], this document supersedes TD 40/94. In combination with CD 116 [Ref 1.I], this document supersedes TD 50/04. This document also supersedes elements of TD 70/08 that relate to priority and signal-controlled junctions.

Contractual and legal considerations

This document forms part of the works specification. It does not purport to include all the necessary provisions of a contract. Users are responsible for applying all appropriate documents applicable to their contract.

Introduction

Background

This document provides requirements and advice on the geometrical design of at-grade priority and signal-controlled junctions.

In addition to signal controlled junctions, this document provides a single point of reference for the geometric design of at-grade priority junctions that has been historically split across a number of documents. It merges and rationalises the content of TD 41/95 and TD 42/95 and incorporates the priority junction elements of compact grade separated junctions and wide single 2+1 lanes, which were previously covered by TD 40/94 and TD 70/08 respectively.

In order to remove duplication across the various types of priority junctions defined by the previous documents, priority junctions are now formed of two key elements. These two elements are the priority junction (the layout of the minor road arm) and the major road central treatment (the layout of the major road aspect of the junction, e.g. a ghost island arrangement). This approach allows for flexibility of varying the form of the layout of the minor road and/or major road while removing the repetition and ambiguity resulting from the entire junction being treated as a single component in the previous documents.

In order to rationalise and remove duplication between direct access layouts, the definition of a direct access is now only used for a single field, single dwelling, single-use public utilities site or single-use highway maintenance site. A priority junction is for anything greater; however, the requirements/advice for a priority junction differ depending on whether the road provides a through route or not (i.e. an entrance to a business park or development). (i.e. an entrance to a business park or development).

Other notable changes/additions from the previous documents listed above include:

- 1) advice on permitting particular movements at single lane dualling and dual carriageway priority junctions (predominantly relating to the right turns out of the minor road), along with new geometrical parameters for such junctions where right turns out of the minor road are prevented;
- 2) expanded advice on the use of nearside passing bays, including recommended dimensions; and,
- 3) improvements made to the way visibility splays are defined at priority junctions to ensure that a full splay is provided rather than just a line of visibility from the minor road set back point.

Assumptions made in the preparation of this document

The assumptions made in GG 101 [Ref 6.N] apply to this document.

Abbreviations

Abbreviations

Abbreviation	Definition
AADT	Annual average daily traffic
ASL	Advance stop-line
HGV	Heavy goods vehicle
SLD	Single lane dualling
SSD	Stopping sight distance
S2	Single carriageway cross-section, 1 lane each direction (see CD 127 [Ref 1.N])
WS2	Wide single-carriageway cross-section, 1 lane each direction (see CD 127 [Ref 1.N])
WS2+1	Wide single 2+1 carriageway cross-section, 2 lanes one direction, 1 lane opposing direction (see CD 127 [Ref 1.N])

Terms and definitions

Terms

Term	Definition
Auxiliary lane	An additional lane provided on the nearside of the major road carriageway at junctions to increase merge or diverge opportunity and/or provide additional space for weaving traffic.
Changeover	A carriageway layout which effects a change in the designated use of the middle lane of a WS2+1 road from one direction of traffic to the opposite direction.
Collector road	A road separate to the junction which collects other local roads and accesses into a link that connects to the minor road in advance of the junction.
Compact grade separated junction	A grade separated junction designed with a two-way unsegregated connector road between the major and minor road. The connector road joins the major road via a priority junction designed to this document.
Corner taper	A short taper following the corner radius provided to accommodate the swept path of larger vehicles.
Crossroads	For the purpose of this document, crossroad junctions are where the centre line of a minor road, when extended across the major road, fits within the carriageway of an opposing priority junction.
Design vehicle	The design vehicle for at-grade priority and signal controlled junctions is a 16.5 metres long articulated heavy goods vehicle (HGV).
Desirable minimum stopping sight distance	Desirable minimum stopping sight distance (SSD) is as defined in CD 109 [Ref 5.N].
Direct access	A connection to an all-purpose trunk road providing access to only one of the following, which does not provide a through route: 1) a single dwelling; 2) a single field; 3) a single-use public utilities site (such as an electric substation) where access is needed for maintenance of that specific site only; or, 4) a single-use highway maintenance site (such as an attenuation pond) where access is needed for maintenance of that specific site only.
Duplicate primary signal(s)	Where there is more than one primary signal, additional signals erected to the offside are duplicate primary signal(s).
Ghost island	A major road central treatment that uses road markings to create an additional lane to allow traffic waiting to turn right from the major road into the minor road to do so without impeding through traffic movement.

Terms (continued)

Term	Definition
Hatched area	An area of road marking hatching used to discourage and/or channel vehicle movements.
Intervisibility zone	The area within a signal-controlled junction that ensures road users can see other road users (including pedestrians) between each stop line.
Major road central treatment	A collective term for the central treatments associated with ghost island, single lane dualling or dual carriageway junctions.
Major road	A road on which traffic has priority of movement over adjoining roads.
Minor road	A road on which traffic concedes priority to traffic on the major road.
Overtaking sections	Sections of two-lane single carriageway where the combination of horizontal and vertical alignment, visibility and or width is such that there are clear opportunities for overtaking using the opposing lane, as described in CD 109 [Ref 5.N].
Phase	The sequence of conditions applied to one or more streams of vehicular traffic or pedestrian traffic which always receive identical light signal indications.
Primary signal	A light signal erected near the stop line. NOTE: Where there is more than one signal located near a stop line, the signal on the nearside is the primary signal.
Priority junction	A junction controlled by a 'Give Way' or 'Stop' arrangement. NOTE 1: Stop arrangements are only used where there are severe visibility restrictions. NOTE 2: Direct accesses can operate in a similar manner but are not classed as priority junctions. NOTE 3: A priority junction can include a merge taper where the formal 'Give Way' road marking is replaced by an edge of carriageway road marking.
Reservoir length	The length required for queuing between the opposing arms of a staggered junction.
Rural roads	Rural roads are as defined in CD 109 [Ref 5.N].
Secondary signal	Traffic signals located beyond the primary signal, facing the same direction of traffic flow. NOTE: The information given by a secondary signal is the same as that given by the primary signal with which it is associated, but additional information compatible with that of the primary can also be given.
Signal-controlled junction	A junction that has full or part-time signals on one or more of its arms.

Terms (continued)

Term	Definition
Simple priority junction	A form of priority junction where there is no major road central treatment, such as a ghost island or single lane dualling, and no merging/diverging tapers or auxiliary lanes.
Single lane dualling	A single carriageway major road central treatment that uses physical traffic islands to provide space for right turning movements in and/or out of the minor road in order to not impede through traffic movement.
Stagger distance	The distance along the major road between the centre lines of the two minor roads at a staggered junction.
Staggered junction	A junction arrangement where the major road is continuous through the junction and two opposing minor roads form priority junctions that are offset from one another. NOTE: Two opposing priority junctions are not staggered when the layout of any central treatments do not overlap or the junction spacing is greater than the major road SSD.
Storage length	Storage length is the length over which vehicles can queue without causing obstruction to, or being obstructed by, vehicles in the adjacent lane.
Swept path	The swept path of a vehicle is the movement and path of different parts of a vehicle when that vehicle is undertaking a turning manoeuvre. It is the envelope swept out by the sides of the vehicle body, or any other part of the structure of the vehicle.
Taper merge / diverge	An area of additional carriageway that is tapered to/from the major road, which is provided on the nearside of the major road carriageway at junctions to increase merge or diverge opportunity.
Through route	A road that is for public use, which provides a connection to the wider road network. NOTE: A road that does not form part of a through route requires a road user to access and leave a site through the same junction.
Traffic island	A traffic island is a raised (kerbed) or marked-off area on the road. NOTE: A traffic island can be used to accommodate pedestrian refuges and traffic signals, and as a means of separating lanes of traffic or opposing traffic flows.
Urban roads	Urban roads are as defined in CD 109 [Ref 5.N].
WS2+1 roads	A wide single carriageway road with two lanes of travel in one direction and a single lane in the opposite direction, with a 1 metre hatch separating opposing traffic flows.

1. Scope

Aspects covered

- 1.1 This document shall be used for the geometric design of at-grade priority junctions and signal-controlled junctions.

NOTE 1 This document is applicable to both new and improved junctions.

NOTE 2 This document does not cover the general provision of walking, cycling and horse riding facilities at at-grade priority junctions. Requirements and advice relating to this are provided in CD 143 [Ref 3.N] and CD 195 [Ref 2.N].

- 1.2 This document shall be used for the geometric design of the priority junction element of a compact grade separated junction.

NOTE Requirements for the link road element of a compact grade separated junction are provided in CD 122 [Ref 4.N].

Implementation

- 1.3 This document shall be implemented forthwith on all schemes involving the geometric design of at-grade priority and/or signal controlled junctions on the Overseeing Organisations' all-purpose trunk roads according to the implementation requirements of GG 101 [Ref 6.N].

Use of GG 101

- 1.4 The requirements contained in GG 101 [Ref 6.N] shall be followed in respect of activities covered by this document.

2. Junction selection

Priority junction selection

2.1 Priority junctions shall not be used on motorways or all-purpose dual three-lane carriageways.

2.1.1 Priority junctions should not be located on a sharp curve on a major road.

NOTE 1 *The placement of a priority junction on the inside of a sharp curve is particularly hazardous as this can restrict visibility to a much greater degree than on the outside of a curve, and is likely to create blind spots.*

NOTE 2 *The placement of a priority junction on the outside of a sharp curve can result in drivers on the major road misinterpreting the minor road as the ahead direction. Equally drivers on the minor road could misinterpret the layout as drivers on the mainline as having to give way.*

2.1.2 Priority junctions should only be located on level ground or where any approach that is on a downhill gradient does not exceed 2% over the applicable desirable minimum stopping sight distance (SSD).

2.1.3 The number of priority junctions providing access to the all-purpose trunk roads should be minimised.

NOTE *Minimising the number of junctions on a road can be achieved by connecting side roads and accesses to a collector road running parallel to the main road.*

2.2 Priority junctions that do not form a through route shall not be provided on overtaking sections.

2.3 Simple priority junctions shall only be used on single-carriageway roads without a climbing lane.

2.3.1 The selection of priority junction and major road central treatment for single carriageway roads should be determined based on the standard of major road and traffic flows on both the major and minor roads. Figure 2.3.1 illustrates approximate levels of provision for varying traffic flows.

Figure 2.3.1 Approximate priority junction provision on single carriageway roads based on flows only

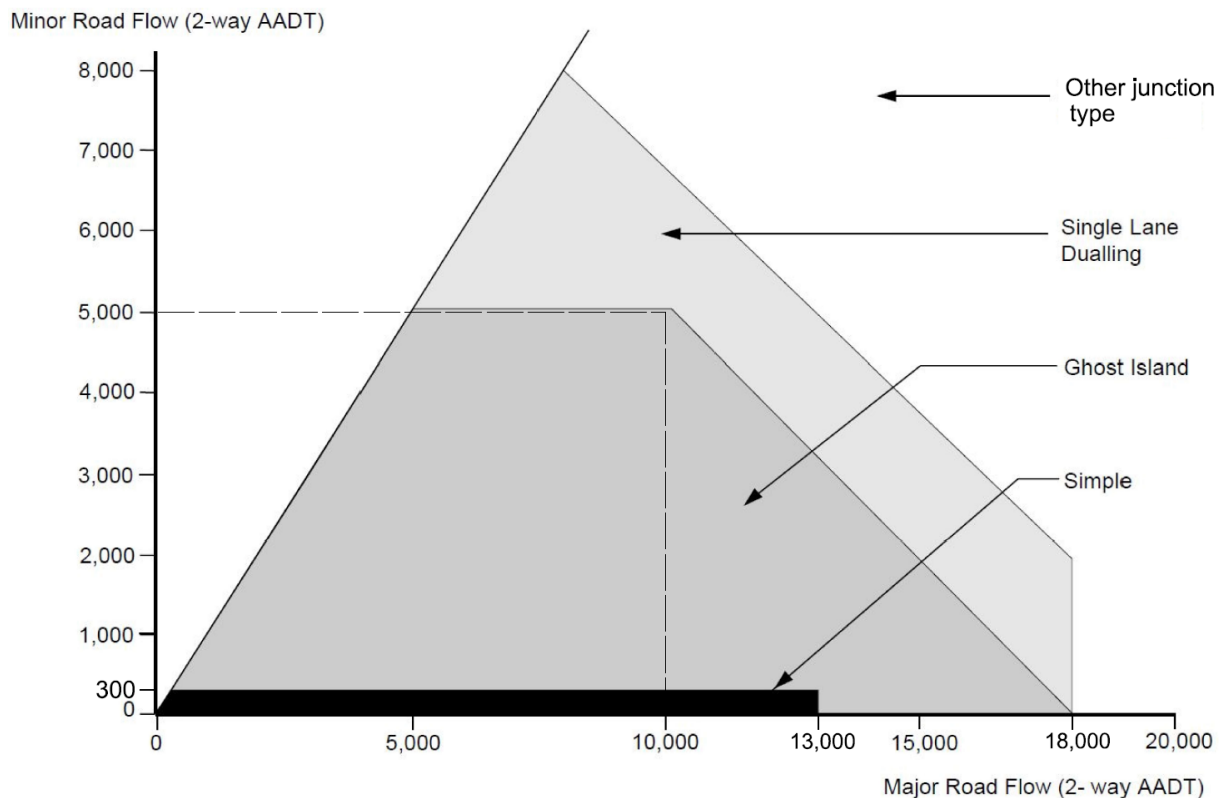

NOTE The 2-way AADT design year flows are used to determine the approximate level of junction provision prior to more detailed traffic modelling to check capacity.

2.3.2 At junctions where there are high seasonal variations, or short intense peaks in the traffic flows, then the appropriate seasonal or peak flows should be used.

NOTE 1 Figure 2.3.1 takes into account traffic delays, entry and turning traffic flows and collision costs.

NOTE 2 Seasonal or peak flows need to be extrapolated to determine revised 2-way AADT flows for use in Figure 2.3.1.

2.4 New priority junctions shall not be sited where they encroach on the visibility requirements of adjacent priority junctions on major roads with:

- 1) a speed limit of greater than 40 mph; or,
- 2) a speed limit of 40 mph or less, where the minor road forms part of a through route.

NOTE 1 In England and Wales, on major roads with a speed limit of 40 mph or less, decisions on priority junctions where the minor road does not form part of a through route, and direct accesses, are first dealt with by the local planning authority.

NOTE 2 The placement of priority junctions in relation to lay-bys is covered in CD 169 [Ref 3.].

WS2+1 roads

2.5 On WS2+1 roads, priority junctions shall only be;

- 1) located at changeovers;
- 2) located at WS2+1 to S2 interfaces; or,
- 3) on the adjoining S2 road, at least 500 metres from the point where the road cross-section changes from a WS2+1 cross section.

NOTE 1 Priority junctions can be used to facilitate a changeover of overtaking lanes on WS2+1 roads. This is shown diagrammatically in Figures 2.5N1a to 2.5N1d.

Figure 2.5N1a Priority junction layouts at changeovers - conflicting layout

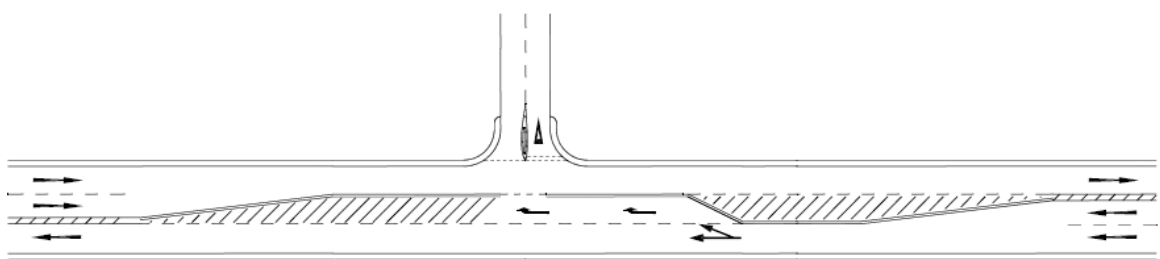

Figure 2.5N1b Priority junction layouts at changeovers - non-conflicting layout

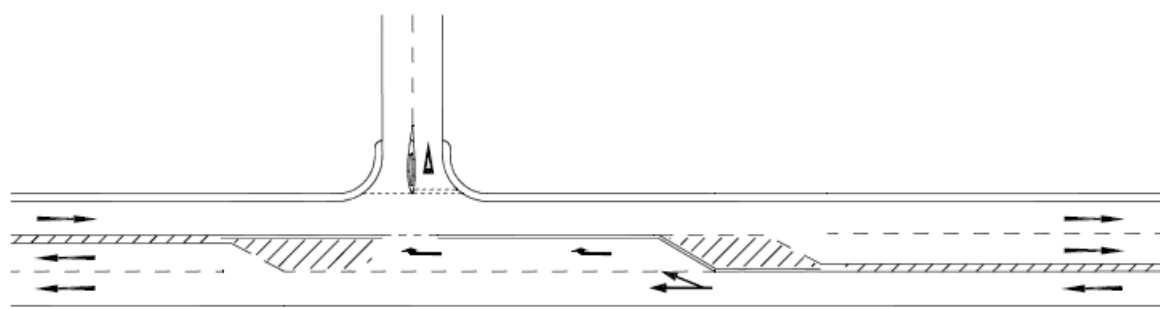

Figure 2.5N1c Staggered junction layouts at changeovers - conflicting layout

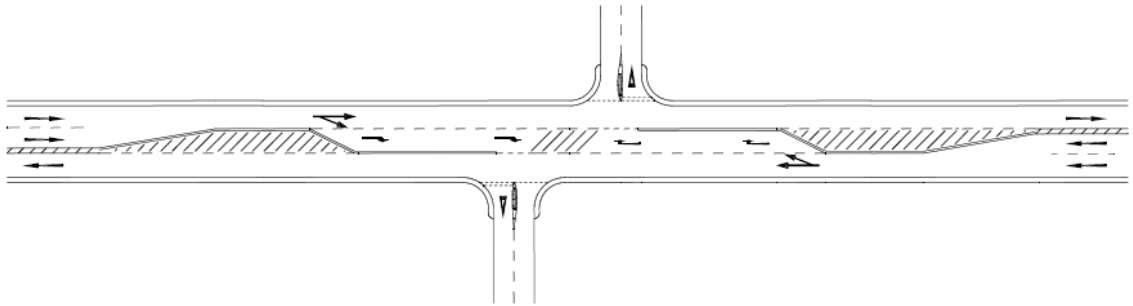
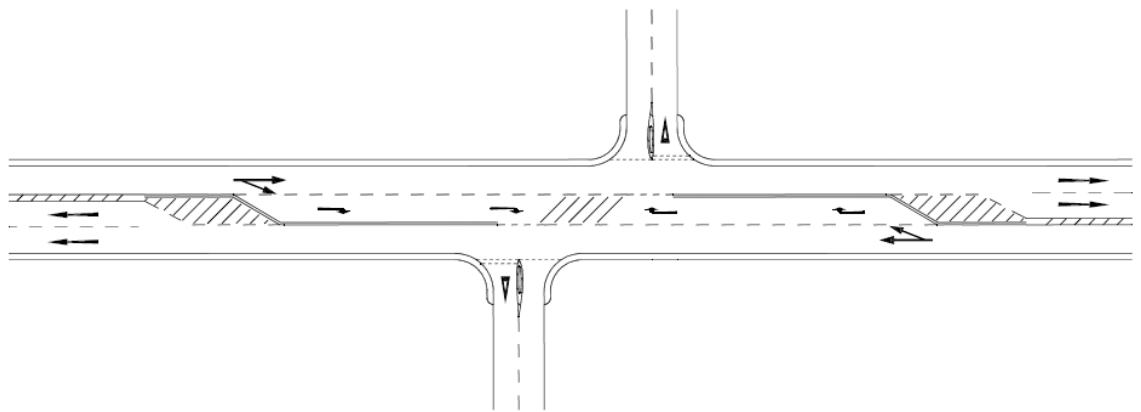

Figure 2.5N1d Staggered junction layouts at changeovers - non-conflicting layout



NOTE 2 Priority junctions can be used at the interface between WS2+1 roads and S2 single carriageway roads. This is shown diagrammatically in Figures 2.5N2a to 2.5N2e.

Figure 2.5N2a Right-turn at end of single lane section

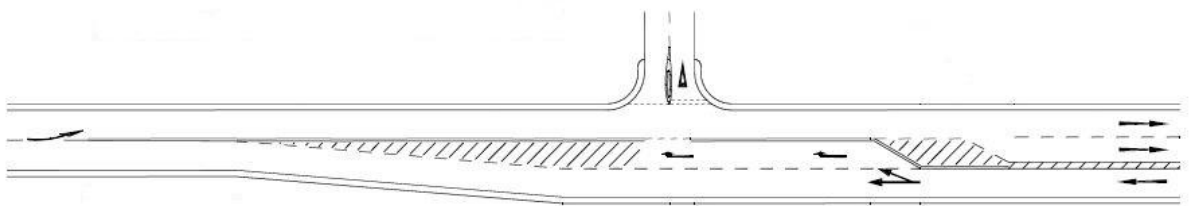

Figure 2.5N2b Right-turn at end of overtaking lane section

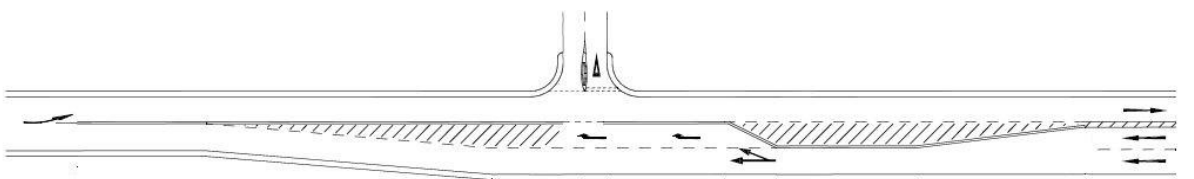

Figure 2.5N2c Right-turn at start of single lane section

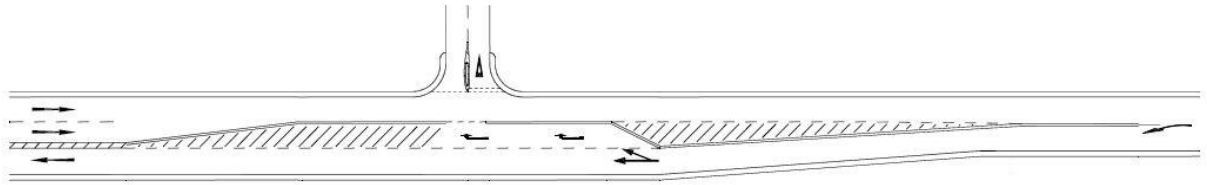

Figure 2.5N2d Right-turn at start of overtaking lane section

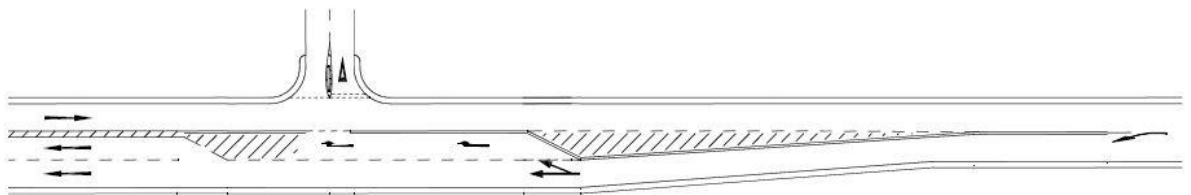
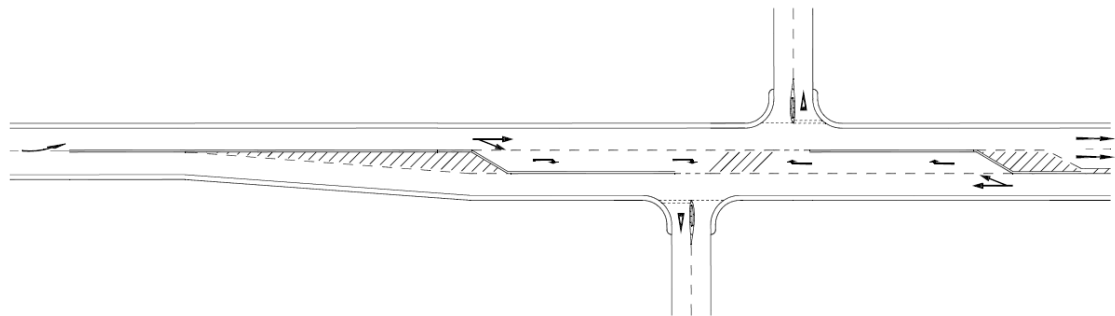

Figure 2.5N2e Staggered junction layouts at WS2+1 interface



2.6 Priority junctions on WS2+1 roads shall include either;

- 1) a ghost island central treatment; or,
- 2) a physical central reserve to prevent right turn movements.

NOTE At priority junctions the middle lane is dedicated to right-turning traffic, with a single lane provided in each direction through the junction.

2.7 Left-in/left-out priority junctions shall only be provided on WS2+1 roads where they are included as part of a compact grade separated junction, with a physical central reserve instead of the middle lane.

2.8 Where there is a physical central reserve on WS2+1 carriageways, u-turns shall be prohibited at both ends of the central island.

2.9 An additional fourth lane for right turning vehicles shall not be provided on WS2+1 roads.

Dual carriageway roads

2.10 At priority junctions on dual carriageways, where right turns in and/or out of the minor road are to be accommodated, the central reserve shall be widened to provide waiting space for vehicles turning right (as illustrated in Figure 2.10).

Figure 2.10 Example of dual carriageway central reserve widening for a priority junction

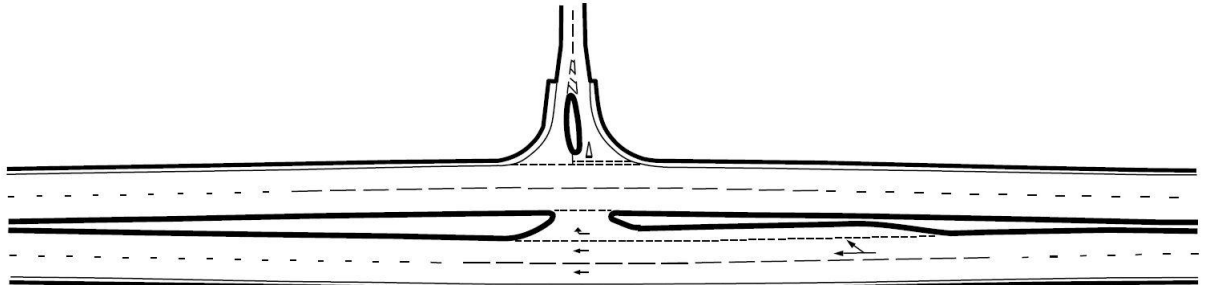

NOTE *Provision of turning facilities allows vehicles of nearly all lengths turning right from the minor road into the major road to carry out the manoeuvre in two stages.*

2.10.1 Priority junctions should not be provided on rural dual carriageway roads where the minor road flows exceed 3,000 vehicles AADT 2-way.

2.11 Priority junctions shall be located a minimum of 500 metres in both directions from the end of the physical central reserve where the carriageway changes from a single carriageway to a dual carriageway.

NOTE *Priority junctions at changes in carriageway cross section can lead to an increase in accident potential because of the merging manoeuvres that will be occurring on the major road at this point.*

Major road central treatment selection

2.12 Priority junctions shall include a major road central treatment when the minor road flow exceeds 300 vehicles 2-way annual average daily traffic (AADT), or the major road flow exceeds 13,000 vehicles 2-way AADT.

NOTE 1 *Priority junctions can be designed as all movement junctions or restricted movement junctions (with individual movements deterred or prevented).*

NOTE 2 *Priority junctions can be used in combination with a major road central treatment and as part of a compact grade separated junction.*

NOTE 3 *Priority junctions with no major road central treatment are simple priority junctions.*

Ghost island central treatment

2.13 Ghost islands shall not be used where overtaking opportunities on adjacent links are restricted.

2.13.1 On new single carriageways where overtaking opportunity is limited, ghost island junctions should be sited on non-overtaking sections.

2.14 Ghost islands shall only be used where major road traffic flows allow traffic turning right out of the minor road to do so in one manoeuvre.

2.14.1 On urban roads with a speed limit of 30 mph or less, where a ghost island cannot be accommodated, a passing bay as illustrated in Figure 2.14.1 may be used.

Figure 2.14.1 Illustrative example of a passing bay

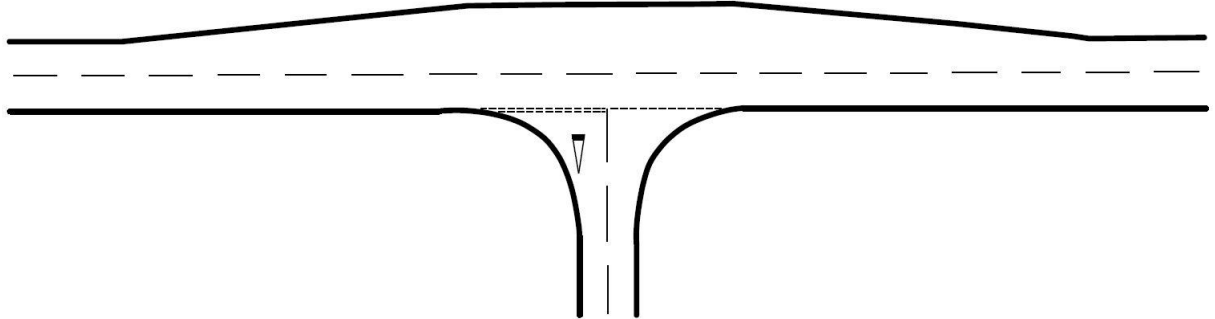

NOTE *A passing bay provides space for through vehicles to pass vehicles waiting to turn right into the minor road but only at low speed.*

Single lane dualling (SLD) central treatment

- 2.15 SLD shall not be used within 3 km of the tip of taper to a dual carriageway.
- 2.16 SLD shall not be used on WS2+1 or where there is a climbing lane in one direction through the junction.
- 2.17 SLD layouts shall only be used on roads with hard strips.
- 2.18 SLD shall be formed by widening the major road to provide a central reservation that includes waiting space for vehicles turning right.
- 2.18.1 SLD should be used in preference to ghost islands where overtaking opportunities on adjacent links are restricted, and/or where traffic turning right out of the minor road would need to make this manoeuvre in two stages.
- 2.18.2 On new single carriageways where overtaking opportunity is limited, SLD junctions should be sited on non-overtaking sections.

NOTE *The improved carriageway cross section can result in a tendency for drivers to speed up through the junction where slow moving vehicles can be crossing or turning.*

Permitted movements at SLD and dual-carriageway priority junctions

- 2.19 Where right turns in or out of a minor road at SLD junctions are restricted by traffic islands, u-turns shall be prohibited at both ends of the central island.
- 2.19.1 Right turning movements out of the minor road at SLD and dual-carriageway junctions should be restricted by traffic islands where these movements can be accommodated at a subsequent junction, such as a roundabout.

NOTE 1 *Restricting right turn movements out of the minor road at SLD and dual-carriageway junctions can reduce collision risk by:*

- 1) *removing interaction between vehicles turning right into the minor road and out of the minor road, which can cause confusion as to who has priority; and,*
- 2) *eliminating the need for larger vehicles that cannot be fully sheltered in the central gap having to undertake the right turn out in one stage or overhanging the through lanes if they decide to undertake the movement in two stages.*

NOTE 2 *A round trip of approximately 2 km can be considered an acceptable diversion to eliminate right turn movements out of the minor road for private accesses, developments and little used minor or unclassified roads at SLD and dual-carriageways junctions.*

NOTE 3 *Illustrative examples of SLD and dual carriageway priority junctions with restricted movements are shown in Figures 2.19.1N3a and 2.19.1N3b.*

Figure 2.19.1N3a Example of a SLD junction with the right turn out of the minor road prevented

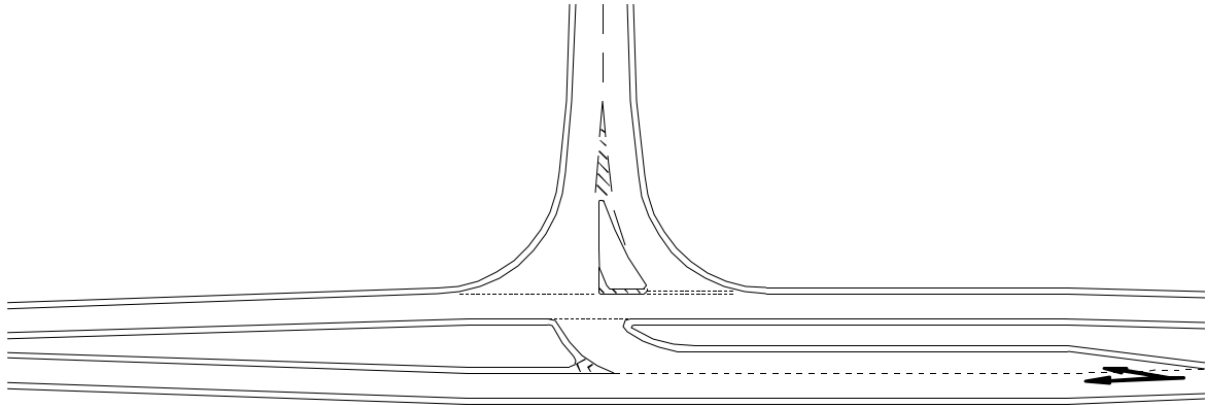
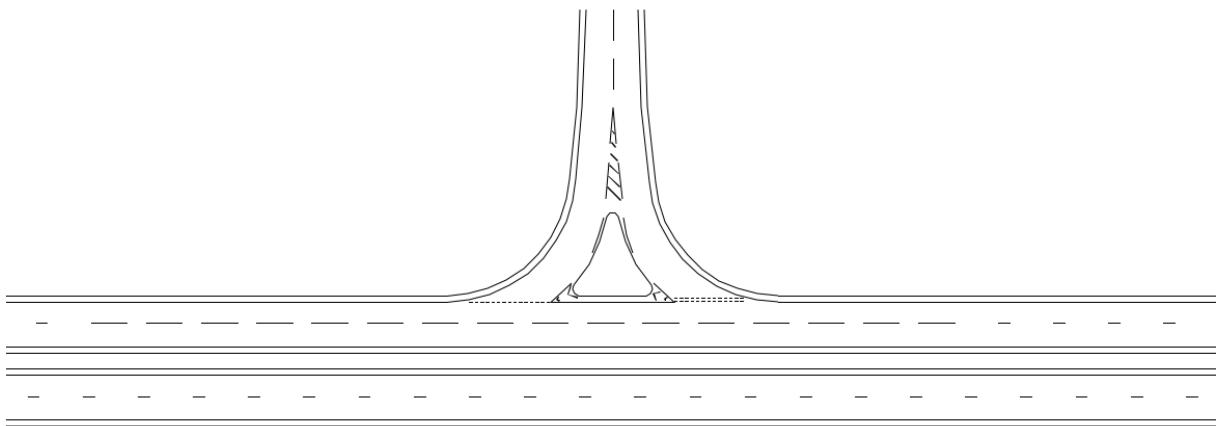

Figure 2.19.1N3b Example of a dual carriageway priority junction with right turns into and out of the minor road prevented



Crossroads and staggered junctions

2.20

Where the centre line of a minor road, when extended across the major road, fits within an opposite priority junction carriageway (as illustrated on Figure 2.20) the junction shall be designed as a crossroads and not a staggered junction.

Figure 2.20 Crossroad layout

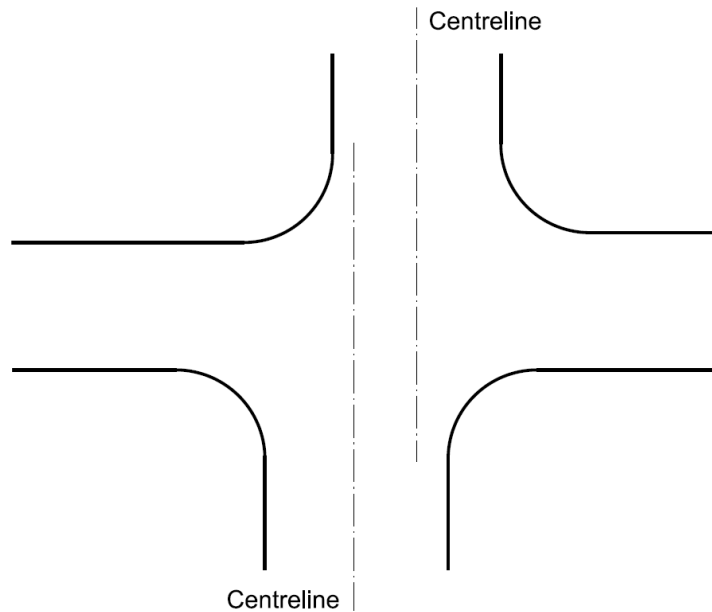

- 2.21 Crossroads shall only comprise two opposing simple priority junctions.
- NOTE 1* As simple priority junctions are not permitted on dual carriageway roads, crossroads can only be used on single carriageway roads.
- NOTE 2* Staggered junctions are safer than crossroads where a significant proportion of the flow on the minor roads is a crossing movement.
- 2.22 The stagger distance of a junction shall be measured as the distance along the major road between the centre lines of the two minor roads.
- 2.22.1 Where staggered junctions are provided they should be right/left staggers (where minor road traffic crossing the major road first turns right, proceeds along the major road and then turns left).
- NOTE* Right/left staggers are preferred to left/right staggers because traffic turning between the minor roads is less likely to have to wait in the centre of the major road.
- 2.23 The minimum right/left stagger distance shall be:
 - 1) 50 metres for priority junctions with no major road central treatment;
 - 2) 50 metres for a ghost island junction;
 - 3) 40 metres for a SLD junction; and,
 - 4) 60 metres for a dual carriageway junction.
- 2.24 The minimum left/right stagger distance for a priority junction with no major road central treatment shall be 50 metres.
- 2.25 The minimum left/right stagger distance for a priority junction with no major road central treatments shall be as given in Table 2.25.

Table 2.25 Minimum stagger distances for left/right staggered junctions

Design speed (kph)	Stagger distance (metres)		
	Ghost island	Single lane dualling	Dual carriageway
50	50	--	60
60	50	--	60
70	60	--	60
85	75	75	75
100	100	100	100
120	--	--	130

NOTE For higher design speeds, the distance is based on the sum of the two deceleration lengths lying side by side plus the turning lengths (and queuing lengths, if appropriate) at each end, otherwise it is based on the manoeuvring requirements of the design vehicle.

2.26 Staggered junctions shall not be used on climbing lane sections.

Signal-controlled junctions

2.27 Where the 85th percentile speed on the approach roads is greater than or equal to 104 kph (65 mph), a signal-controlled junction shall not be provided.

Direct accesses

2.28 Direct accesses shall not be used on motorways, all-purpose dual three-lane carriageways and on WS2+1 roads.

2.29 Direct accesses shall not be provided on overtaking sections.

2.29.1 Direct accesses should be avoided where possible.

NOTE 1 The primary purpose of the trunk road network is to provide for the safe and expeditious movement of long distance through traffic. That means strictly limiting the number of direct accesses to trunk roads.

NOTE 2 Direct accesses can be joined together with a link or service road before they join the main carriageway of the trunk road.

2.29.2 Direct accesses on single carriageway roads should not be positioned facing each other.

2.30 On dual carriageways, gaps in the central reserve to accommodate right turns in and out of a direct access shall not be provided.

2.31 Direct accesses shall not be provided at locations where the major road gradient is greater than 4%.

3. Visibility

Minor road approach visibility

Priority junctions

- 3.1 On a minor road approach to a priority junction, there shall be unobstructed visibility of the junction from a distance corresponding to the desirable minimum SSD for the design speed of the minor road, including the 'give way' sign where present, as illustrated in Figure 3.1.

Figure 3.1 Priority junction approach SSD visibility

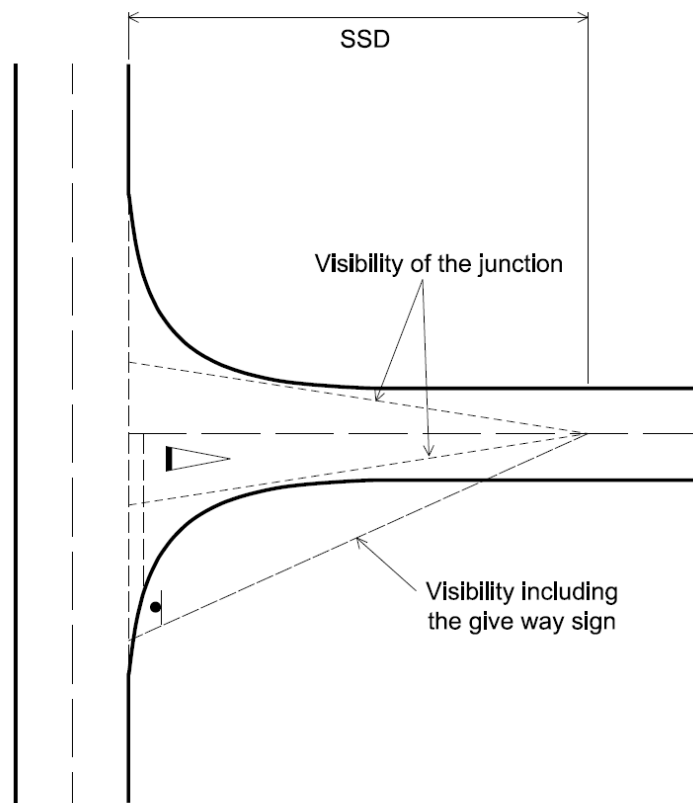

NOTE SSD is measured from the eye heights and to the object heights given in CD 109 [Ref 5.N].

- 3.2 An approaching road user shall be able to clearly see the junction form from a minimum distance of 15 metres back along the centreline of the minor road, measured from the continuation of the line of the nearside edge of the running carriageway of the major road (as illustrated in Figure 3.2a and 3.2b).

Figure 3.2a Priority junction approach visibility

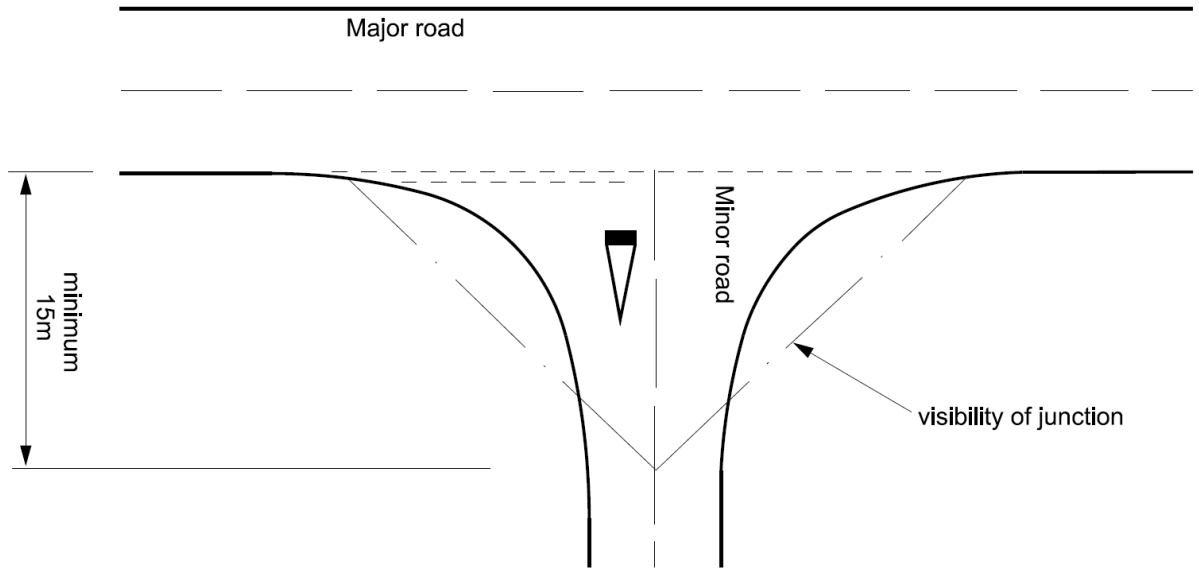
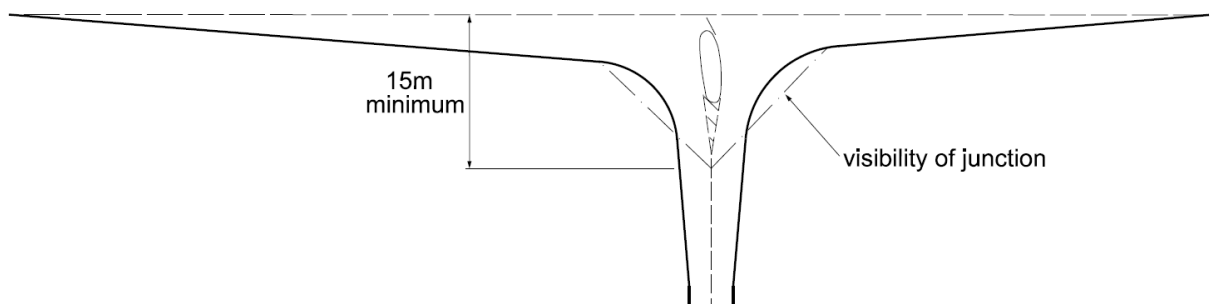

Figure 3.2b Priority junction approach visibility (incorporating tapers on the mainline and traffic island on the minor road)



NOTE 1 The 15 metre measurement is from the continuation of the line of the nearside edge of the running carriageway not the continuation of the back of the major road hard strip if present.

NOTE 2 Visibility is measured from the eye heights and to the object heights using the envelope of visibility in CD 109 [Ref 5.N].

Direct accesses

3.3 Where a direct access crosses a footway, a visibility splay shall be provided in accordance with Figure 3.3.

Figure 3.3 Visibility at the back of footway crossing

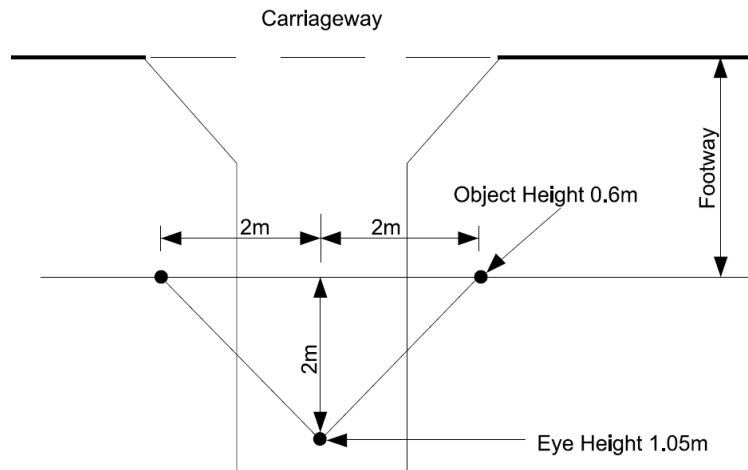

Junction visibility

Measurement of visibility at minor roads and direct accesses

3.4 Unobstructed visibility shall be provided at all priority junctions and direct accesses by a visibility splay formed between the following three points, as illustrated in Figure 3.4:

- 1) a point W corresponding to the intersection point between the minor road centreline and the major road edge of carriageway;
- 2) a point X setback along the minor road centreline measured from the continuation of the line of the nearside edge of the running carriageway of the major road; and,
- 3) a point Y on the major road nearside edge of carriageway, corresponding to the desirable minimum SSD for the speed of the major road measured along the edge of the major road carriageway from point W.

Figure 3.4 Priority junction visibility splays

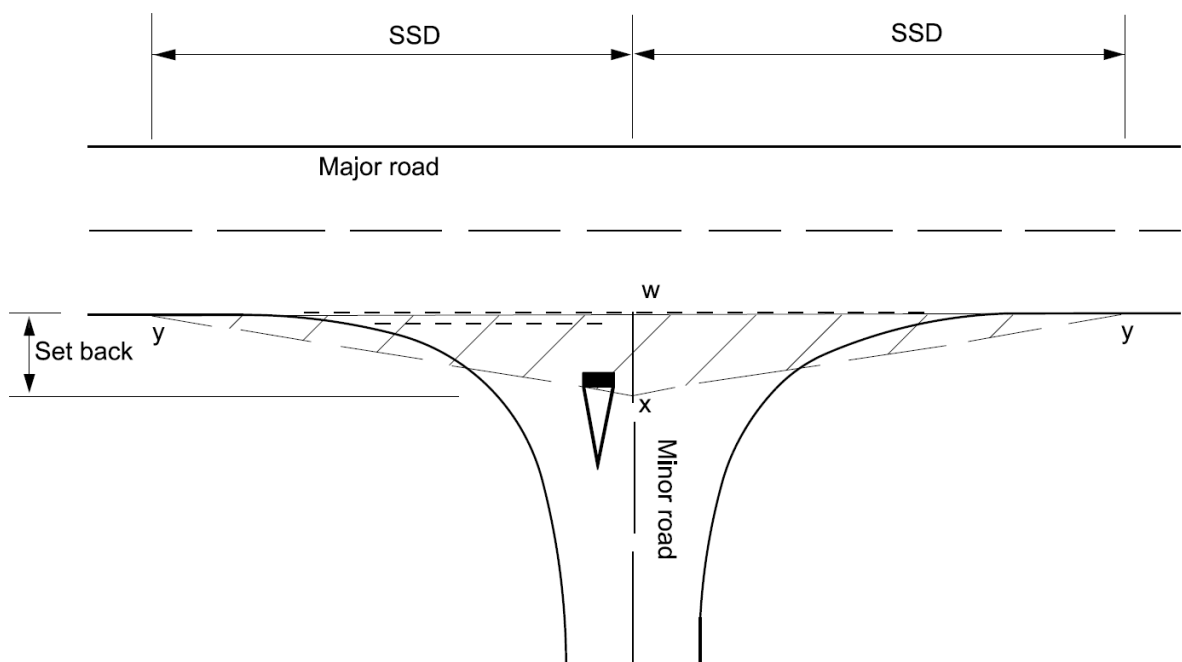

- NOTE 1* Visibility is measured from the eye heights and to the object heights given in CD 109 [Ref 5.N].
- NOTE 2* The visibility splays shown are for a junction where left and right splays are required.
- NOTE 3* Where there are hard strips on the major road, point X is measured from the continuation of the line of the nearside edge of the running carriageway of the major road.
- NOTE 4* Inappropriate positioning of lay-bys, bus stops, traffic signs and other street furniture can result in obstruction to visibility splay.
- NOTE 5* Parked vehicles can obstruct visibility splays and where necessary restrictions can be introduced to mitigate this risk.
- 3.5 The speed of the major road for determining point Y in the visibility splay shall be based on:
- 1) design speed only for direct accesses and priority junctions on new major roads;
 - 2) design speed only for priority junctions that form part of a through route on existing major roads; and
 - 3) design speed or speed measurement for direct accesses and priority junctions that do not form part of a through route on existing major roads.
- NOTE* Speed measurement of an existing major road involves calculating the 85th percentile speed of traffic.
- 3.6 A visibility splay to the right on the minor road shall be provided:
- 1) at all priority junctions and direct accesses where minor road traffic can join a 2-way major road; and
 - 2) at all priority junctions and direct accesses where minor road traffic can turn left to join a 1-way major road.
- 3.6.1 Visibility splays to the right on the minor road should also be provided at priority junctions and direct access where minor road traffic can turn right to join a 1-way major road and there are contraflow provisions (e.g. for cyclists).
- 3.7 A visibility splay to the left on the minor road shall be provided:
- 1) at all priority junctions and direct accesses where minor road traffic join a 2-way single carriageway major road;
 - 2) at all priority junctions and direct accesses where minor road traffic can turn right to join a 2-way dual-carriageway road and the central reserve gap is not wide enough to accommodate a waiting design vehicle; and,
 - 3) at priority junctions and direct accesses where minor road traffic can turn right to join a 1-way major road.
- 3.7.1 Visibility splays to the left on a 1-way road should also be provided at priority junctions and direct access where minor road traffic can turn left to join a 1-way major road and there are contraflow provisions (e.g. for cyclists).
- NOTE* Where the minor road is one way leading from the major road, no visibility splays for vehicles turning out of the minor road are required as these movements are not permitted.
- 3.7.2 On a 1-way major road, visibility splays may be provided in both directions for vehicles turning out of the minor road.
- NOTE* Visibility splays in both directions at a 1-way major road provides a level of future proofing, and accommodates potential traffic management arrangements.
- 3.8 The minimum distance used to locate point X shall satisfy one of the following:
- 1) for direct access:
 - a) 4.5 metres; or,
 - b) 2.0 metres.
 - 2) for simple priority junctions:

- a) 9.0 metres; or,
 - b) 2.4 metres.
- 3) for all other priority junctions:
- a) 9.0 metres; or,
 - b) 4.5 metres.

- 3.8.1 The minimum distance used to locate point X should be in accordance with a) for each junction/access type.
- 3.8.2 Where it is not feasible to locate point X fully in accordance with a), the minimum distance used to locate point X should be as close to a) as practicable, but no less than b).
- 3.9 Where the line between points X and Y falls partially within the major road carriageway, an additional area shall be added to the visibility splay formed by drawing a line from X to a point tangential to the nearer edge of the major road running carriageway, as illustrated in Figure 3.9.

Figure 3.9 Additional area of visibility on the outside of a curved major road

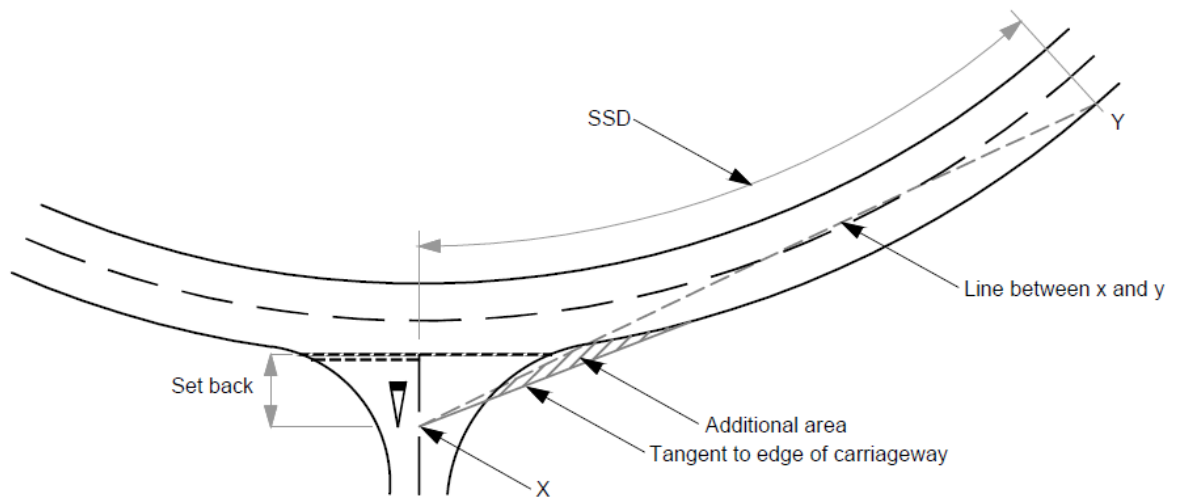

NOTE The additional area of visibility on the outside of the curve (as illustrated in Figure 3.9) applies to both the left and right of a priority junction/direct access.

- 3.10 Where a priority junction/direct access is located on the outside of a major road curve, an additional area shall be added to the visibility splay in the verge on the inside of the major road curve, formed by a line between the following two points, as illustrated in Figure 3.10:
- 1) a point X at a set back distance of 2.4 m; and,
 - 2) a point V on the major road offside edge of running carriageway, corresponding to the desirable minimum SSD for the speed of the major road.

Figure 3.10 Additional area of visibility on the inside of a curved major road

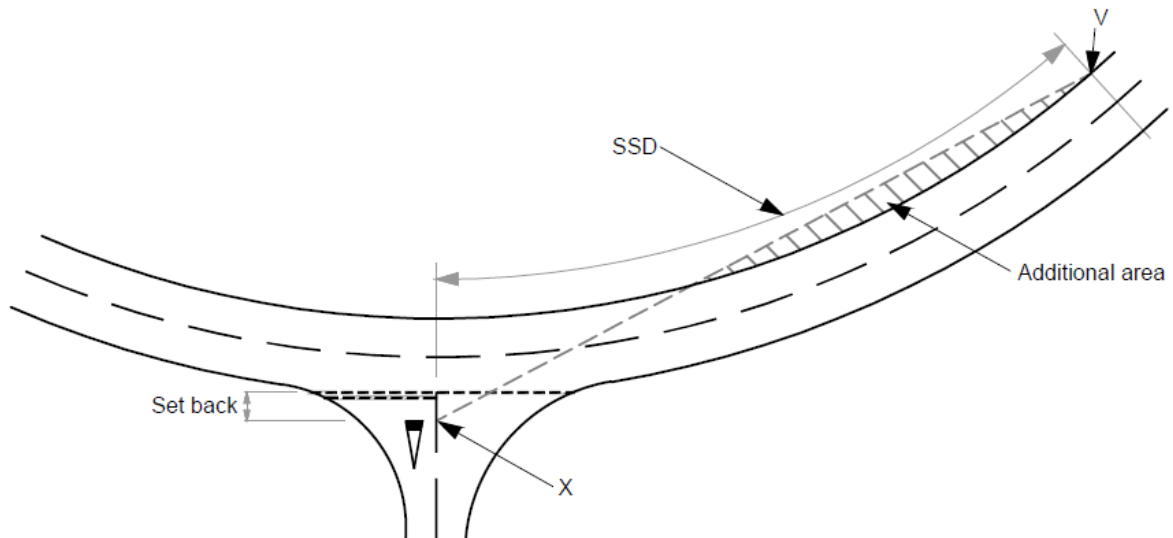

NOTE 1 The additional area of visibility on the inside of the curve (as illustrated in Figure 3.10) applies to both the left and right of a priority junction/direct access.

NOTE 2 Where there are hard strips on the major road, point V is measured to the nearside edge of the running carriageway not the back of the major road hard strip.

NOTE 3 Providing the additional visibility in the verge on the inside of a major road curve allows drivers to see the full extent of the carriageway and approaching vehicles for the desirable minimum SSD.

3.11 The desirable minimum SSD at all priority junctions shall not be available from an X distance greater than 9 metres.

NOTE In open areas, it can be necessary to artificially restrict the visibility splay to prevent the desirable minimum SSD being available from an X distance of greater than 9 metres.

Measurement of visibility in the central reserve

3.12 Unobstructed visibility shall be provided in the centre of the major road, on dual carriageway and SLD junctions where right turns are permitted, by a visibility splay formed between the following three points, as illustrated in Figure 3.12:

- 1) the intersection point between the centre of the opening and the offside edge of major road carriageway;
- 2) a point 2.4 metre setback along the centre of the opening measured from the continuation of the line of the offside edge of the running carriageway of the major road; and,
- 3) a point Y on the major road offside edge of carriageway, corresponding to the desirable minimum SSD for the design speed of the major road measured from the 2.4 metre setback point.

Figure 3.12 Central reserve visibility splays

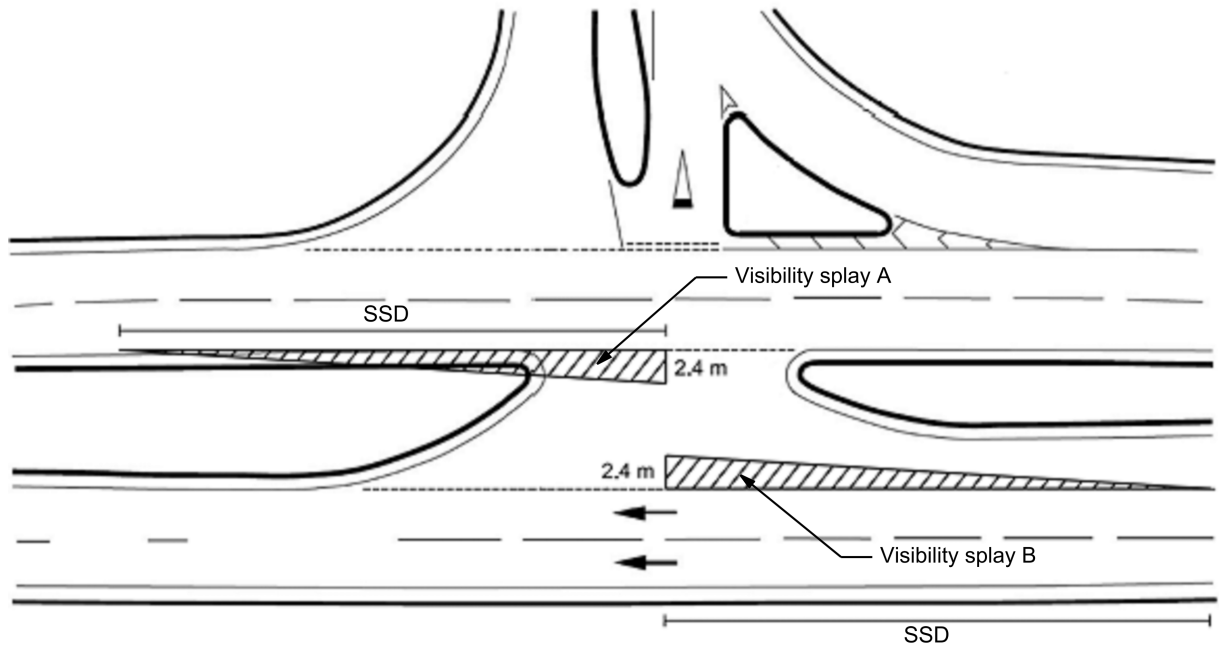

NOTE

Visibility is measured from the eye heights and to the object heights given in CD 109 [Ref 5.N].

3.13

Visibility splays in the central reserve of dual carriageways or SLD shall be provided in the following circumstances:

- 1) visibility splay A, as illustrated in Figure 3.12, where right turn into the minor road is permitted/and/or;
- 2) visibility splay B, as illustrated in Figure 3.12, where right turn out of the minor road is permitted.

4. Geometric design of direct accesses

- 4.1 Direct accesses shall only be used where access is to only one of the following and that access will be subject to less than 50 vehicle movements per week:
- 1) a single dwelling;
 - 2) a single field;
 - 3) a single-use public utilities site (such as an electric substation) where access is needed for maintenance of that specific site only; or,
 - 4) a single-use highway maintenance site (such as an attenuation pond) where access is needed for maintenance of that specific site only.
- 4.1.1 A direct access should not be provided on trunk roads where it is feasible to provide an alternative access onto the local road network.
- 4.1.2 A priority junction may be provided instead of the direct access.
- 4.2 The layout in Figure 4.2 shall be provided as the minimum level of provision for a direct access.

Figure 4.2 Direct access layout

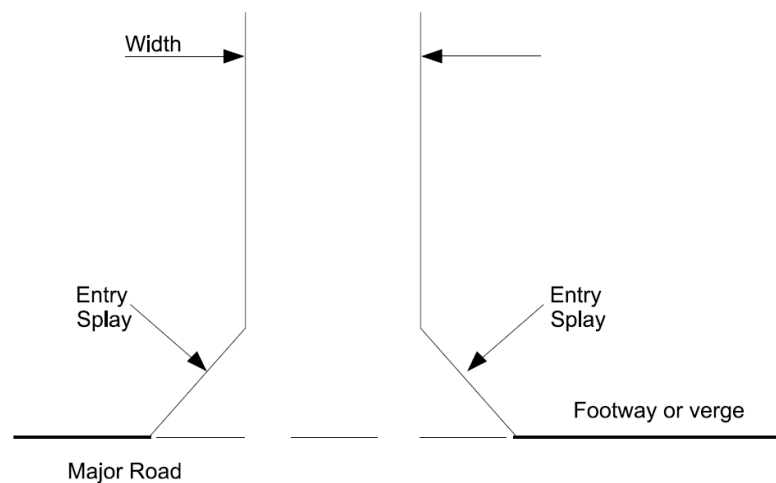

NOTE *Hardened strips can be provided at field accesses to assist in the removal of mud from tyres and equipment prior to entering the trunk road.*

- 4.2.1 The width of a direct access for a single dwelling should be a minimum of;
- 1) 3.1 metres where building regulations apply to the access width; or,
 - 2) 2.5 metres where building regulations do not apply to the access width.

NOTE *A minimum width of 3.1 metres allows access by a typical fire and rescue service vehicle as detailed in The Building Regulations 2010, Approved Document B - Fire Safety, Volume 1 - Dwellings [Ref. ISBN 9781 1 914124 02 0 [Ref 2.]].*

- 4.2.2 The width of a direct access for fields, public utilities sites and highway maintenance sites should be a minimum of 3.5 metres.
- 4.2.3 The entry splays at direct accesses should be a minimum of 1 metre by 1 metre for a single dwelling and 2 metre by 2 metre for fields, public utilities sites and highway maintenance sites.
- 4.3 Where entrance gates are provided across a direct access they shall be set back to accommodate one vehicle in the access, clear of the main running lane and footway if one is present.

NOTE *The vehicle to be accommodated is the largest type expected to use the access on a regular basis, which in the case of farm vehicles can include a trailer.*

- 4.3.1 Gates for direct accesses should open away from the highway.
- 4.3.2 Where it is not possible to accommodate gates opening away from the highway, the setback should be increased to accommodate them being fully open without encroaching into the carriageway.
- 4.4 For direct accesses, the gradient on the approach to the trunk road shall not exceed 10% either uphill or downhill.
- 4.5 For direct accesses, the gradient on the access approach shall not exceed 4% over one of the following distances, measured from the edge of the major road carriageway:
- 1) 10 metres; or,
 - 2) 5 metres.
- 4.5.1 The distance over which the gradient does not exceed 4% should be in accordance with 1).
- 4.5.2 Where it is not feasible to provide a distance over which the gradient does not exceed 4% fully in accordance with 1), the distance should be as close to 1) as practicable, but no less than 2).
- 4.5.3 For direct accesses, the gradient on the access approach should not exceed 2% immediately adjacent to the trunk road.
- NOTE** *Providing a relatively flat section prevents drivers having to perform a 'hill start', which reduces the risk of vehicles stalling or inadvertently rolling out into the major road.*

5. Geometric design of priority junctions

General

- 5.1 The road camber on the major road shall be retained through the junction with the minor road graded into the channel line of the major road.
- 5.2 Allowance shall be made for the swept turning paths of the worst case design vehicle which is expected to use the priority junction, unless:
 - 1) the design vehicle is expected to form only a very small percentage of the total number of vehicles that will use the junction; and,
 - 2) any swept path conflicts as a result of the design vehicle encroaching into other lanes will not occur on bends.

NOTE In cases where hard strips are present, the design vehicle is assumed to use the additional space during turns and at simple junctions, the design vehicle can encroach into opposing traffic lanes.

- 5.3 For priority junctions, the maximum gradient on the minor road approach shall satisfy one of the following over a minimum distance of 15 metres, measured from the edge of the major road carriageway:
 - 1) 2%; or,
 - 2) 4%.

5.3.1 The maximum gradient on the minor road approach should be in accordance with 1).

5.3.2 Where it is not feasible to provide a maximum gradient on the minor road approach fully in accordance with 1), the maximum gradient should be as close to 1) as practicable, but no less than 2).

NOTE Providing a relatively flat section prevents drivers having to perform a 'hill start', which reduces the risk of vehicles stalling or inadvertently rolling out into the major road.

- 5.4 At new priority junctions, the angle of the minor road approach, measured over 15 metres from the edge of the major road carriageway, shall satisfy one of the following:
 - 1) 90 degrees; or,
 - 2) a minimum of 70 degrees.

5.4.1 The angle of the minor road approach should be in accordance with 1).

5.4.2 Where it is not feasible to provide the angle of the minor road approach fully in accordance with 1), the angle should be as close to 1) as practicable, but no less than 2).

NOTE Angles less than 70 degrees can result in drivers having to look excessively over their shoulders or the major road approach being in a vehicle blind spot.

Corner radii and corner radii tapers

- 5.5 At all priority junctions, corner radii shall be provided where the edge of the carriageways or kerb lines of the major and minor roads intersect at each corner where turning movements need to be accommodated.
- 5.6 Corner radii shall be measured for simple priority junctions, and priority junctions with merge/diverge tapers or auxiliary lanes in accordance with Figure 5.6.

Figure 5.6 Corner radii

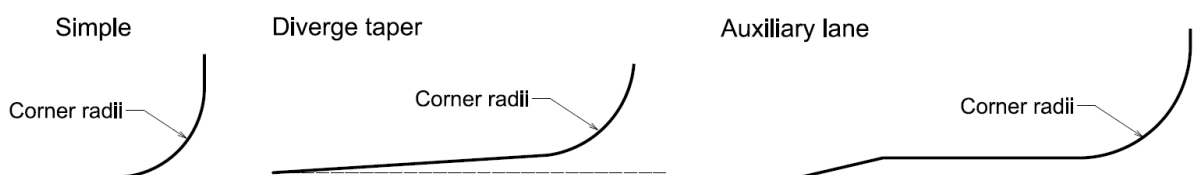

5.6.1 At simple priority junctions where no provision is to be made for the design vehicle, the minimum corner radii should be:

- 1) 6 metres in urban areas; and,
- 2) 10 metres in rural areas.

5.6.2 At simple priority junctions where provision is made for the design vehicle, the corner radii should be:

- 1) 10 metres in urban areas followed by a corner taper of 1:5 over a distance of 30 metres;
- 2) 15 metres in rural areas followed by a corner taper of 1:10 over a distance of 25 metres; and
- 3) 15 metres followed by a corner taper of 1:8 over a distance of 32 metres, when part of a staggered junction arrangement.

NOTE 1 Merge and diverge tapers allow mainline traffic to accelerate or decelerate, whereas corner tapers allow for the swept path of large vehicles while turning round the corner radii.

NOTE 2 For the left turn into the minor road, the corner taper is provided along the minor road, and for left turns out of the minor road the taper is provided along the major road, as illustrated in Figure 5.6.2N2.

Figure 5.6.2N2 Corner radius tapers at priority junctions without diverge tapers or auxiliary lanes

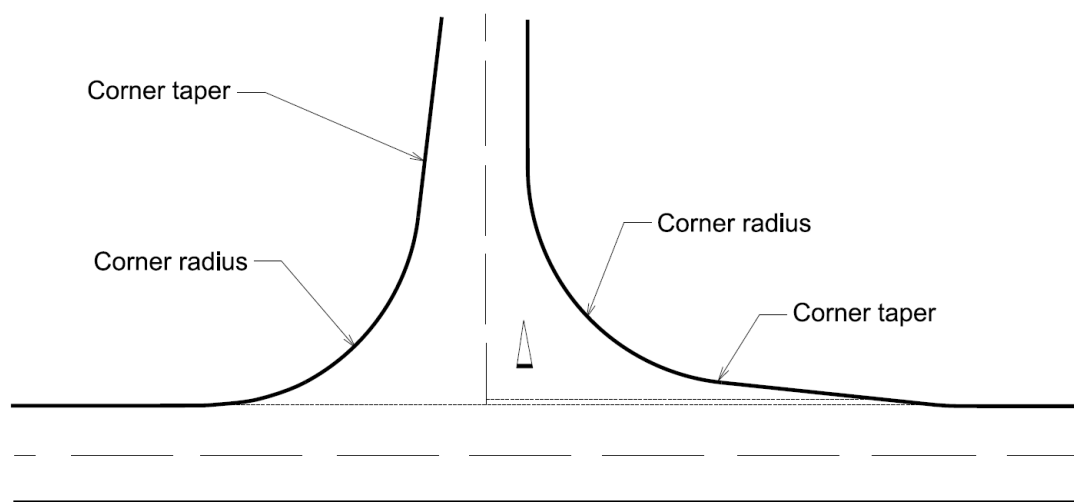

5.6.3 At ghost island junctions where no diverge or merge tapers are provided, the corner radii should be 15 metres followed by a corner taper of 1:6, over a distance of 30 metres.

5.6.4 At ghost island junctions, where a diverge taper/auxiliary lane is provided, the corner radii should be:

- 1) 15 metres followed by a corner taper of 1:6 over a distance of 30 metres at the merge;
- 2) a minimum of 20 metres at the end of the diverge taper/auxiliary lane where the major road design speed is 85 kph; or,
- 3) a minimum of 40 metres at the end of the diverge taper/auxiliary lane where the major road design speed is greater than 85 kph.

5.6.5 At SLD, dual carriageway priority junctions, and where there is a mainline physical central island on a single carriageway road, the diverge corner radii should be:

- 1) 20 metres where no diverge taper/auxiliary lane is provided; or,
- 2) a minimum of 20 metres at the end of the diverge taper/auxiliary lane where the major road design speed is 85 kph; or,

- 3) a minimum of 40 metres at the end of the diverge taper/auxiliary lane where the major road design speed is greater than 85 kph.

NOTE Mainline physical central islands on the single carriageway road are used as part of a compact grade separated junction layout.

5.6.6 At SLD, dual carriageway priority junctions, and where there is a mainline physical central island on a single carriageway road, the merge corner radii should be:

- 1) 20 metres where no merge taper/auxiliary lane is provided; or,
- 2) 25 metres where the major road design speed is 85 kph and a merge taper is provided; or,
- 3) 30 metres where the major road design speed is greater than 85 kph and a merge taper is provided.

NOTE Mainline physical central islands on the single carriageway road are used as part of a compact grade separated junction layout.

Carriageway widths

5.7 Where a physical traffic island is provided on the minor road, the minor road approach lanes shall be 4.0 metres wide at the tip of the associated hatched marking.

NOTE Lane widths do not include hard strips (if they are present).

5.7.1 Where no physical traffic island is provided on the minor road, the existing minor road lane width should at least continue up until the start of the corner radius, or 'give way' line if no corner radius is to be provided.

5.8 Where a physical traffic island is provided on a minor road, the width of the minor road approach lane adjacent to the island at its furthest point from the major road (as illustrated in Figure 5.8) shall be:

- 1) 4.0 metres at simple priority and ghost junctions where there is a single lane at the 'give way' line;
- 2) 4.5 metres at SLD and dual carriageway junctions where there is a single lane at the 'give way' line; and,
- 3) 5.5 metres where the approach widens to two lanes at the 'give way' line.

Figure 5.8 Minor road approach and exit lane widths

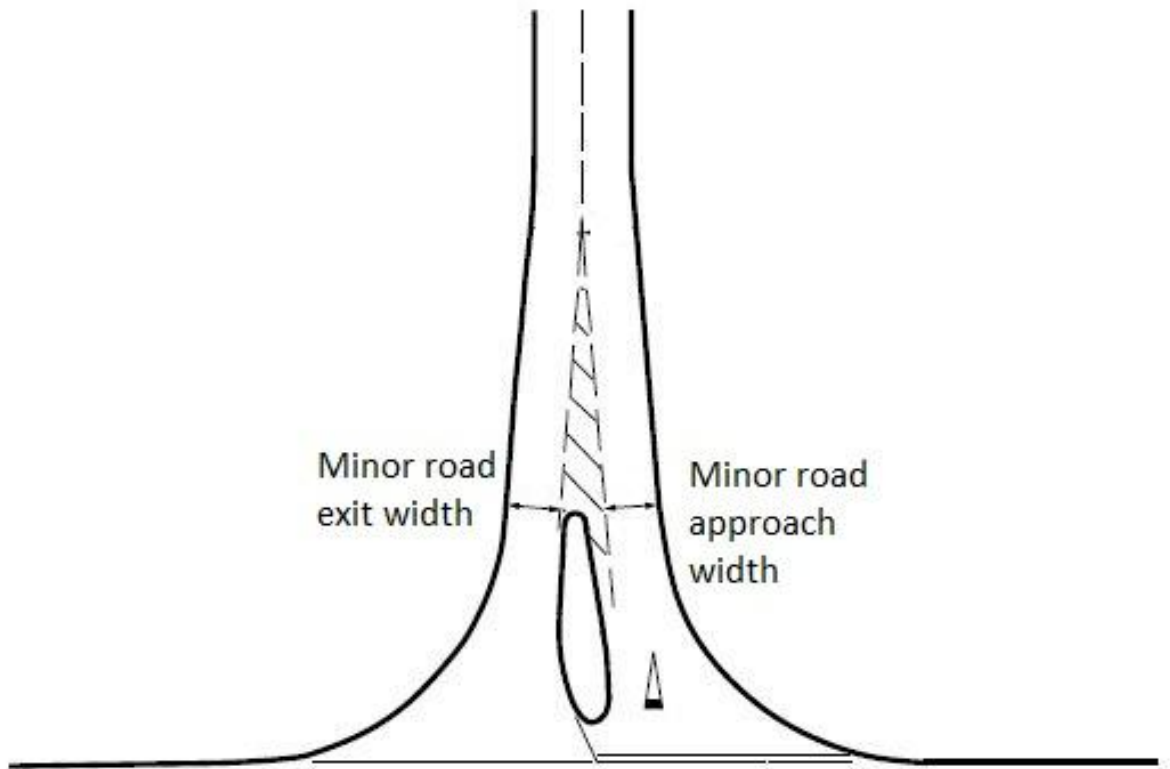

- 5.9 Where a physical traffic island is provided on a minor road, the width of the minor road exit lane adjacent to the island at its furthest point from the major road (as illustrated in Figure 5.8) shall be:
- 1) 4.0 metres at simple priority junctions;
 - 2) 4.5 metres for ghost island junctions; and,
 - 3) 5.0 metres for SLD and dual carriageway junctions.
- 5.10 For curves which have a radius of 90 metres or less, minimum lane widths shall be in accordance with Table 5.10.

Table 5.10 Lane widening on curves of 90 metre radius or less

Inside curve radius (metres)	Single lane carriageway or inside lane of two lane carriageway (metres)	Outside lane of two lane carriageway (metres)
10	8.4	6.5
15	7.1	6.0
20	6.2	5.6
25	5.7	5.2
30	5.3	5.0
40	4.7	4.6
50	4.4	4.3
75	4.0	4.0
90	3.8	3.8

NOTE 1 *Where carriageways are taken around short radius corners added width provides the necessary space to cater for the swept path of larger vehicles.*

NOTE 2 *Lane widths for radii greater than 90 metres are given in CD 109 [Ref 5.N].*

5.11 For actual curve radii that fall between two curve radius values given in Table 5.10, the minimum lane width shall be interpolated.

5.12 On single-lane sections greater than 50 metres in length, there shall be sufficient carriageway space to allow a broken down vehicle to be passed by other vehicles.

5.12.1 For curves which have a radius of 90 metres or less, hard strips that provide an additional 2.5 metres minimum of carriageway space should be added to the single-lane carriageway widths given in column 2 of Table 5.10 to allow a broken down vehicle to be passed by other vehicles.

NOTE *The addition of 2.5 metres carriageway width does not apply to two-lane carriageways in column 2 of Table 5.10.*

Minor road traffic islands

5.13 Physical traffic islands shall have an area of at least 4.5 square metres.

5.13.1 Traffic islands smaller than 4.5 square metres should be defined by road markings.

NOTE *Traffic islands can be used to :*

- a) give guidance to long vehicles carrying out turning movements;*
- b) channelise intersecting or merging traffic streams to reduce collision risk from overrun;*
- c) warn drivers on the minor road that a junction is ahead (this can be particularly useful at crossroads to highlight the need to give way and the location of the 'give way' line);*
- d) provide shelter for vehicles waiting to carry out manoeuvres such as waiting to turn right;*
- e) assist pedestrians and/or cyclists.*

5.13.2 Physical traffic islands should include features to make them conspicuous, e.g. traffic bollards and signage.

5.13.3 Traffic islands on minor roads should be physical islands.

5.14 Physical traffic islands shall be used on the minor road where one or more turning movements are prohibited to prevent or deter such movements.

5.15 Junctions that form part of a compact grade separated junction shall include physical islands to prevent right turn manoeuvres in to and out of the major road.

- 5.16 Traffic islands on the minor road shall be setback a minimum of 1 metre from the edge of running carriageway or in-line with the back of major road hard strip if the hard strip is equal to or greater than 1 metre wide.

Diverge tapers and auxiliary lanes

General

- 5.17 Nearside diverging tapers and auxiliary lanes shall not be provided:
- 1) at simple junctions;
 - 2) where the design speed of the major road is less than 85 kph; and/or,
 - 3) at all other priority junctions that are on the inside of curves.

NOTE Where the minor road is on the inside of a curve, the diverging lane can adversely affect visibility for drivers emerging from the minor road.

- 5.18 At non-simple junctions which are not on the inside of a curve, a nearside diverging taper or auxiliary lane shall be provided in accordance with Table 5.18a and 5.18b.

Table 5.18a Criteria for provision of nearside diverging tapers or auxiliary lanes on A class major roads with a design speed of 85kph or greater

Minor road		A class major roads with a design speed of ≥ 85 kph	
		Flow ≤ 7000 AADT	Flow > 7000 AADT
A and B class road		Yes	Yes
Non A or B class road	left turning traffic ≥ 600 AADT; or, left turning traffic ≥ 450 , $> 20\%$ HGV; or, left turning traffic ≥ 450 , $> 4\%$ gradient.	Yes	Yes
	left turning traffic ≥ 300 and < 600 AADT; or, left turning traffic ≥ 225 and < 450 , $> 20\%$ HGV; or, left turning traffic ≥ 225 and < 450 , $> 4\%$ gradient.	Optional	Yes

Table 5.18b Criteria for provision of nearside diverging tapers or auxiliary lanes all other major roads

Minor road	Major roads other than A class with a design speed of ≥ 85 kph	
	Flow ≤ 7000 AADT	Flow > 7000 AADT
left turning traffic ≥ 600 AADT; or left turning traffic ≥ 450 , $> 20\%$ HGV; or, left turning traffic ≤ 450 , $> 4\%$ gradient.	Yes	Yes
left turning traffic ≥ 300 and < 600 AADT; or, left turning traffic ≥ 225 and < 450 , $> 20\%$ HGV; or, left turning traffic ≥ 225 and < 450 , $> 4\%$ gradient.	Optional	Yes

NOTE Diverging tapers and auxiliary lanes can also be provided on major roads where the design speed is 85 kph or above, and the minor road flows are below the thresholds described in Tables 5.18a and 5.18b.

5.18.1 Where the major road flow exceeds 7000 AADT, auxiliary lanes should be provided instead of tapers for diverging traffic.

NOTE Vehicles decelerating on main carriageways can have an effect on the capacity of the through carriageway by impeding following drivers. The provision of an auxiliary lane allows turning traffic to perform the majority of its deceleration off the mainline.

Diverge taper and auxiliary lane widths and lengths

5.19 Nearside diverging tapers shall be formed by an increase in width to 3.5 metres at the start of the corner radii into the minor road.

5.20 Where right turns into the minor road are permitted, a 'Give Way' line shall be provided at the end of the diverging taper or auxiliary lane.

5.20.1 Where a 'Give Way' line is provided, a traffic island should be provided to segregate the give way from the major road.

5.21 The length of a nearside diverging taper or auxiliary lane shall be measured as the distance from the beginning of the taper up to the "Give Way" line, as shown in Figure 5.21a and 5.21b.

Figure 5.21a Major/minor priority junctions with nearside diverging taper

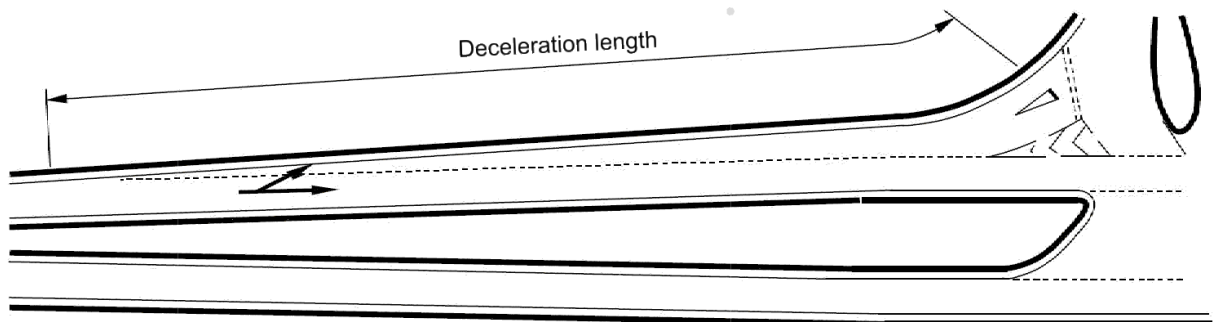
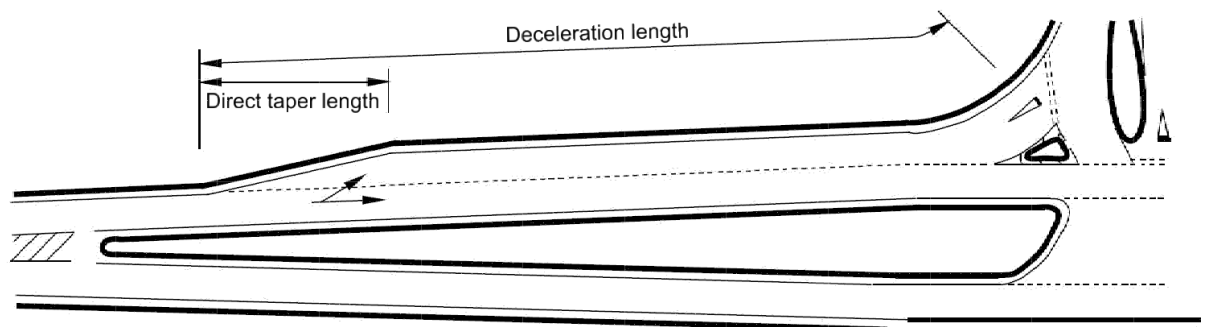

Figure 5.21b Major/minor priority junction with nearside auxiliary lane



5.22 The minimum length of a nearside diverging taper or auxiliary lane shall be in accordance with Table 5.22.

Table 5.22 Diverge taper, auxiliary lane and right turn lane lengths for deceleration

Design speed (kph)	Diverge taper or auxiliary lane deceleration lengths (metres)					Direct taper (metres)
	On 'up' gradient		On 'down' gradient			
	0 - 4 %	over 4 %	0 - 4 %	over 4%		
				Dual carriageways	Single carriageway (including ghost islands and SLD locations)	
50	25	25	25	25	25	5
60	25	25	25	40	25	5
70	40	25	40	55	40	15
85	55	40	55	80	55	15
100	80	55	80	110	80	25
120	110	80	110	150	110	30

NOTE The gradient is the average for a 500 metre length before the minor road.

5.22.1 For design speeds of 100 kph or less, auxiliary lane lengths should be a minimum of 80 metres, and sufficient to allow for the speed change from the major road to the turn into the minor road.

NOTE The auxiliary lane length can also be influenced by any need for reservoir space for turning traffic.

Merging tapers

General

5.23 Merging tapers shall only be used where the major road is a dual carriageway.

5.24 Where the major road is a dual carriageway with a design speed of 85 kph or above, merging tapers shall be provided where:

- 1) the volume of left turning traffic in the design year exceeds 600 vehicles AADT;
- 2) the volume of left turning traffic in the design year exceeds 450 vehicles AADT and the percentage of HGVs exceeds 20%; or,
- 3) the volume of left turning traffic in the design year exceeds 450 vehicles AADT and the merging taper is for an up-gradient of greater than 4%.

5.24.1 Merge tapers may be provided at dual carriageway priority junctions with lesser flows and/or lesser HGV percentages.

NOTE Merge tapers can be particularly useful where there is expected to be a high seasonal use by large or slow moving vehicles.

Merging tapers widths and length

5.25 Merging tapers shall be formed by a decrease in width from 3.5 metres at the end of the corner radii out of the minor road.

5.25.1 A traffic island should be provided to segregate the turning traffic from the major road prior to the commencement of the merging taper.

Figure 5.25.1 Major/minor priority junction with nearside merging taper

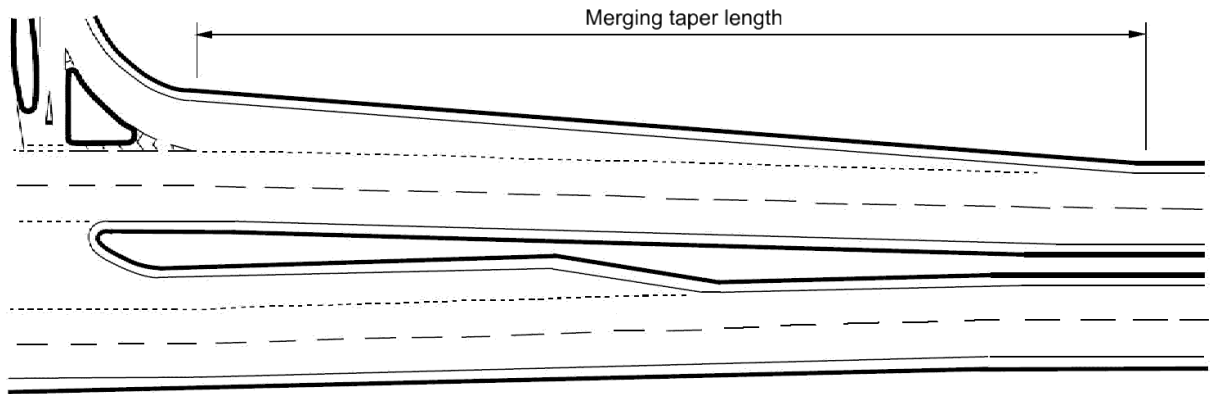

5.26 The minimum lengths of the merging tapers shall be as given in Table 5.26.

Table 5.26 Merging taper lengths (on dual carriageways)

Design speed (kph)	Merging length (metres)	
	Priority junctions where the minor road is not a through route.	All other priority junctions
85	70	90
100	90	110
120	110	130

5.26.1 On dual carriageways with a design speed of 120 kph, the merging taper should be preceded by a 40-metres nose, which has a minimum back of nose width of 2 metres (as indicated on Figure 5.26.1).

Figure 5.26.1 Major/minor priority junction with nearside merging taper (alternative for dual carriageway with a design speed of 120 kph)

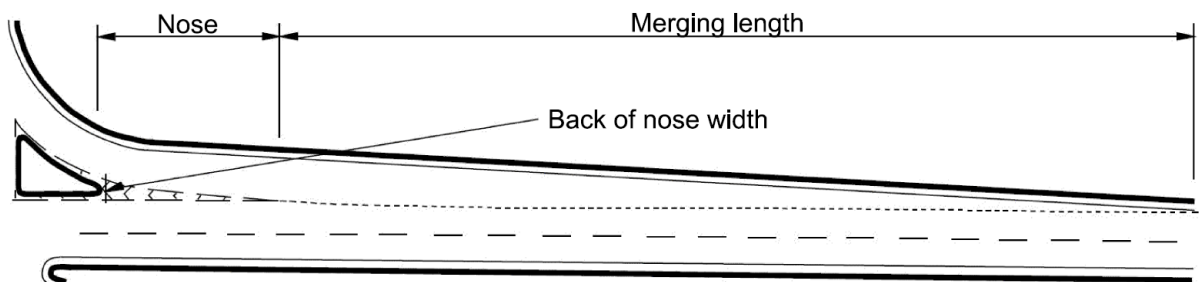

6. Geometric design of major road central treatments

General

Major road central treatment formation excluding on WS2+1 roads

- 6.1 Carriageway widening for a central reserve treatment shall be formed using physical islands or islands defined by road markings.
- 6.1.1 Central treatments for SLD and ghost islands, on single carriageways, should be developed to their maximum width using the tapers shown in Table 6.1.1.

Table 6.1.1 Tapers for central islands on single carriageways

Design speed (kph)	Taper for ghost island and SLD
50	1:20
60	1:20
70	1:20
85	1:25
100	1:30
120	-

- 6.1.2 The tapers given in Table 6.1.1 on single carriageway roads, should be developed:
- 1) symmetrically on straight sections of road;
 - 2) asymmetrically towards the outside of the curve on curved sections of road; and,
 - 3) asymmetrically away from the climbing lane on climbing lane sections.
- 6.1.3 For SLD, the central island should be introduced by means of hatched road markings until there is sufficient width to safely accommodate the keep left arrow traffic sign (at an appropriate size for the speed of the road) on the physical island.
- 6.1.4 Central treatments for dual carriageways should be developed to their maximum width using the tapers shown in Table 6.1.4.

Table 6.1.4 Tapers for central islands on dual carriageways

Design speed (kph)	Taper for dual carriageways
50	1:40
60	1:40
70	1:40
85	1:45
100	1:50
120	1:55

- 6.1.5 The maximum island width should continue through the junction to the tangent point of the minor road radius and the edge of the major road carriageway.

Major road central treatment formation on WS2+1 roads

- 6.2 On WS2+1 roads where compact grade separation is not provided, central treatments shall be formed as shown in Figures 6.2a to 6.2f.

Figure 6.2a Formation of conflicting central treatment layout on WS2+1 road

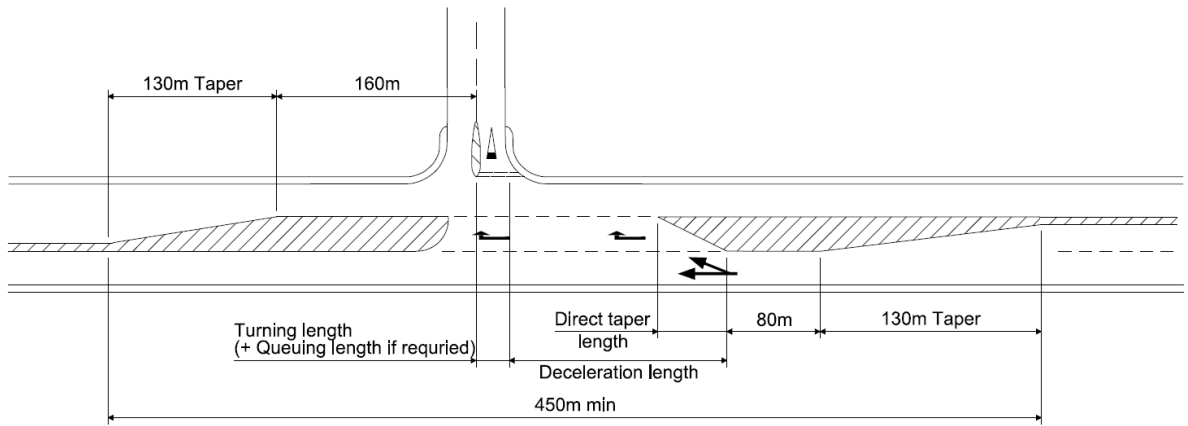

Figure 6.2b Formation of WS2+1 interface central treatment layout on WS2+1 road

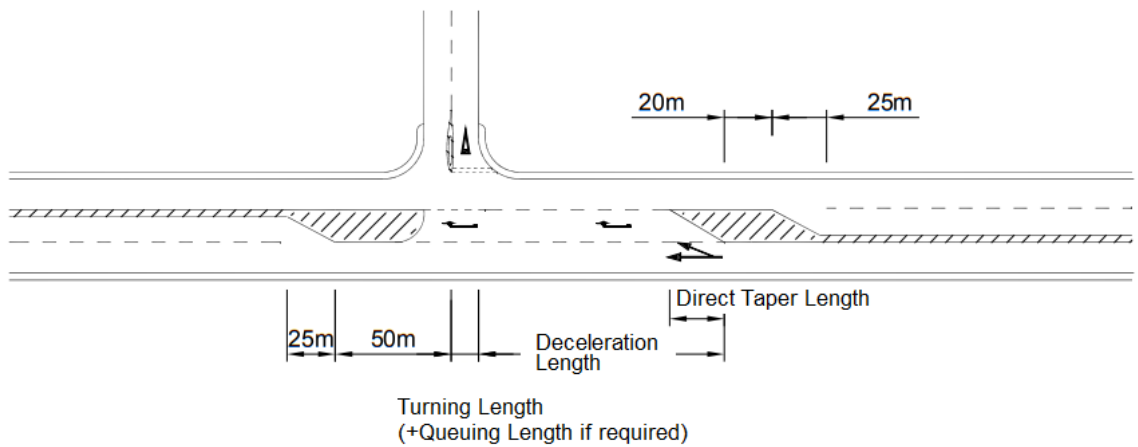

Figure 6.2c Formation of right-turn at end of overtaking lane section on WS2+1 road

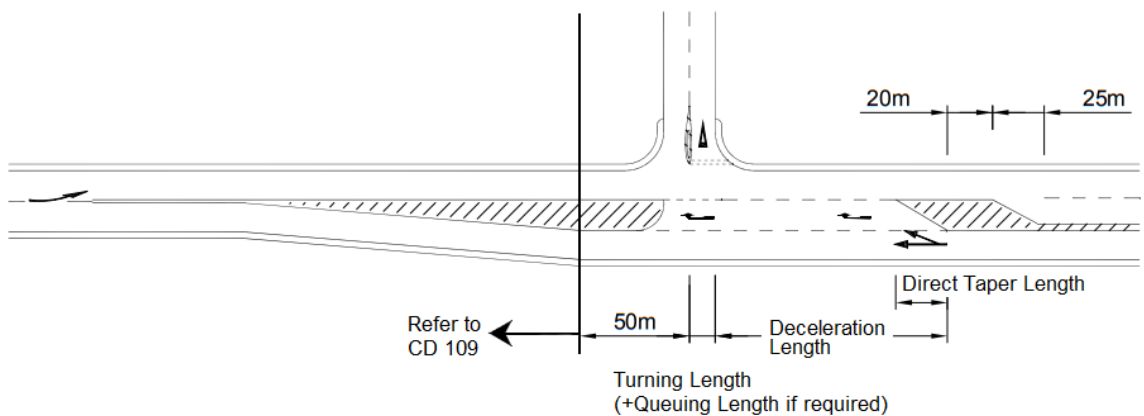

Figure 6.2d Formation of right-turn at end of overtaking lane section on WS2+1 road

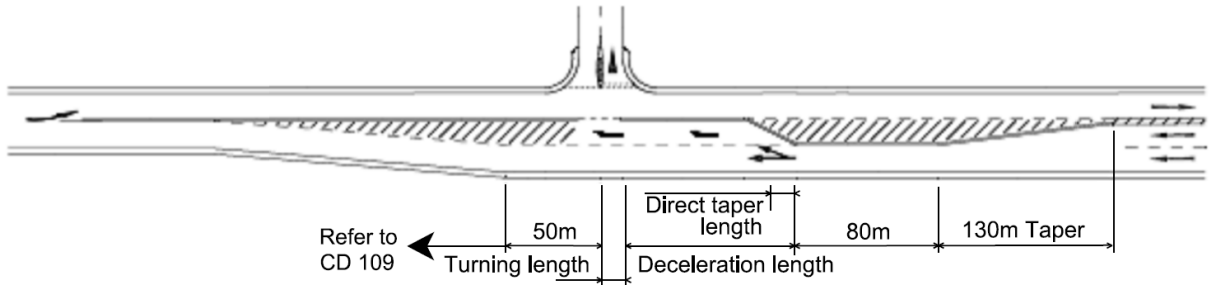

Figure 6.2e Formation of right-turn at start of overtaking lane section on WS2+1 road

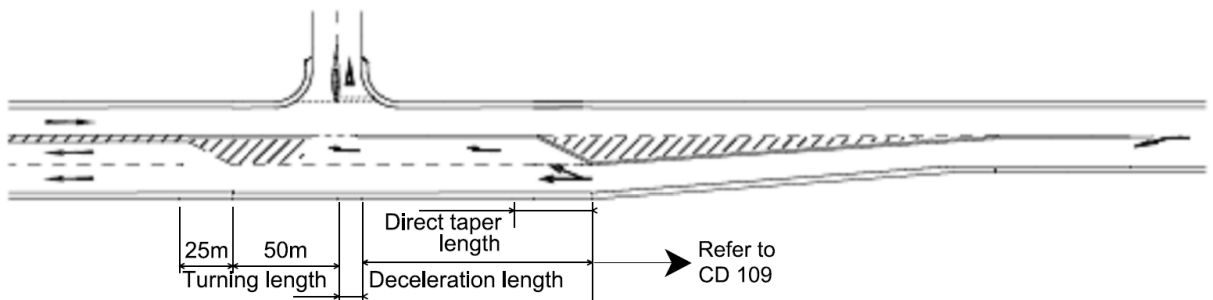
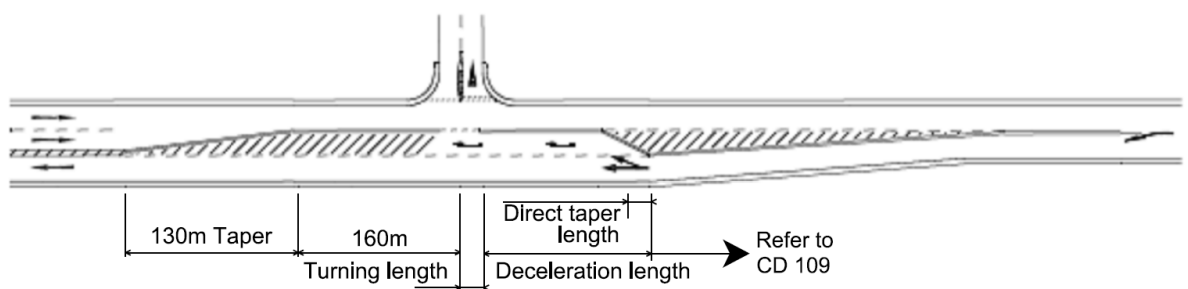

Figure 6.2f Formation of right-turn at start of single lane section on WS2+1 road



NOTE Where a junction is located at the interface between a WS2+1 and a single carriageway, requirements for the carriageway cross-section transition are provided in CD 127 [Ref 1.N].

Major road central treatment right turning lane length

6.3 For all central treatments, the right turning lane shall be comprised of a turning length, deceleration length and direct taper length as shown in Figures 6.3a to 6.3e.

Downloaded from https://www.standardsforhighways.co.uk on 23-Apr-2023, CD 123 Version 2.1.0, published: 29-Nov-2021

Figure 6.3a Major / minor priority junction with a ghost Island on single carriageway

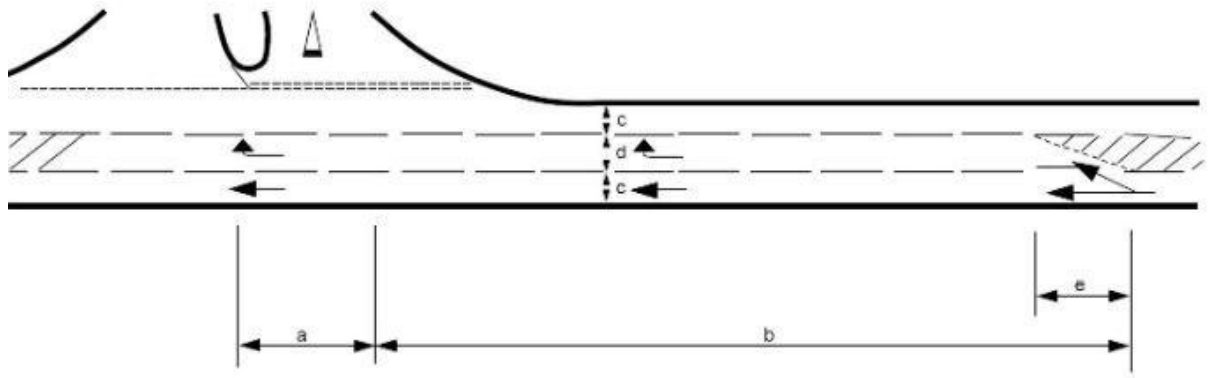

Figure 6.3b Major / minor priority junction with a up-gradient ghost island on climbing lane

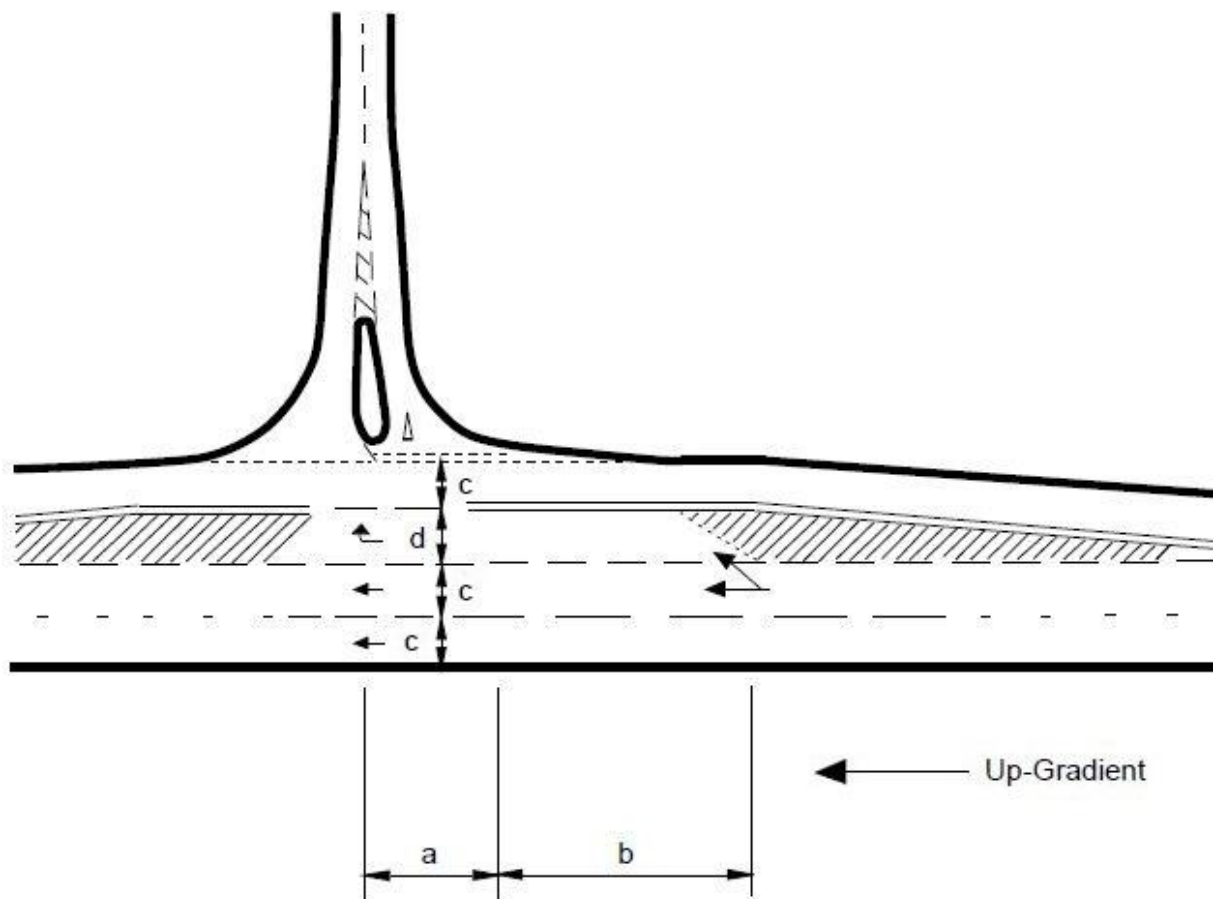

Figure 6.3c Major / minor priority junction with a down-gradient ghost island on climbing lane

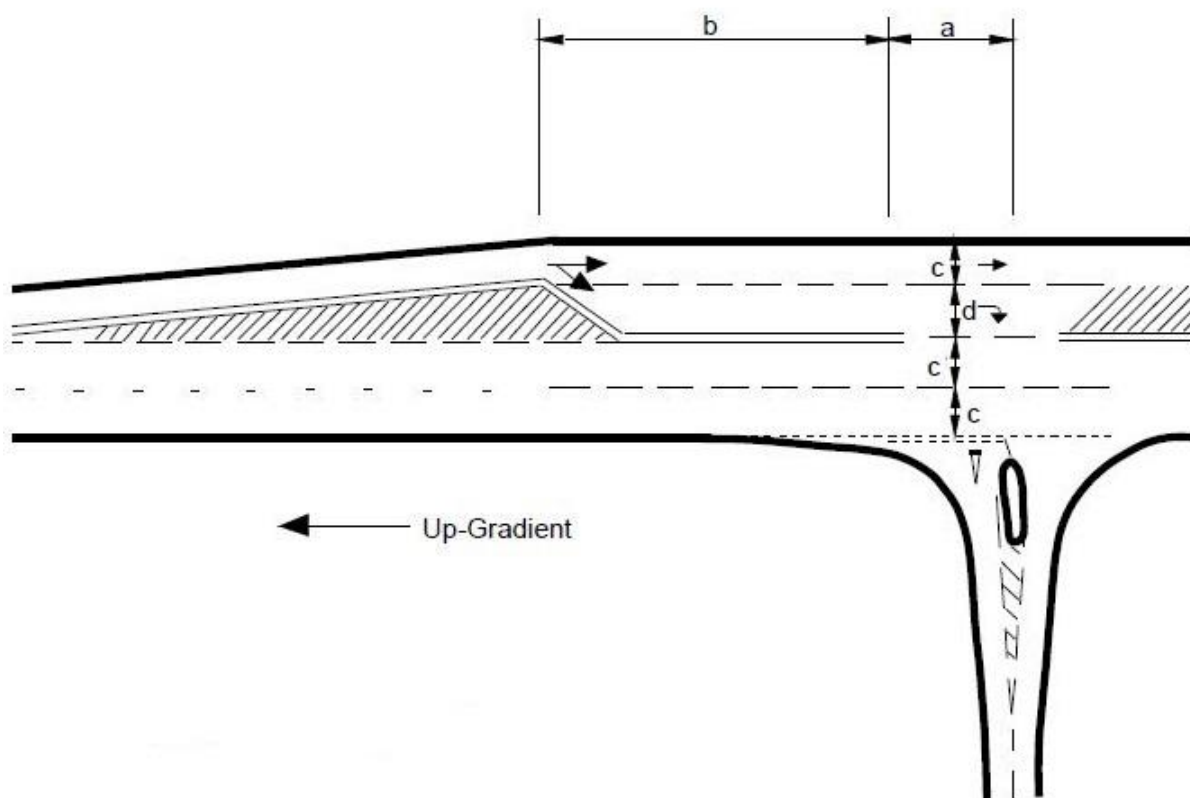

Figure 6.3d Major / minor priority junctions with SLD

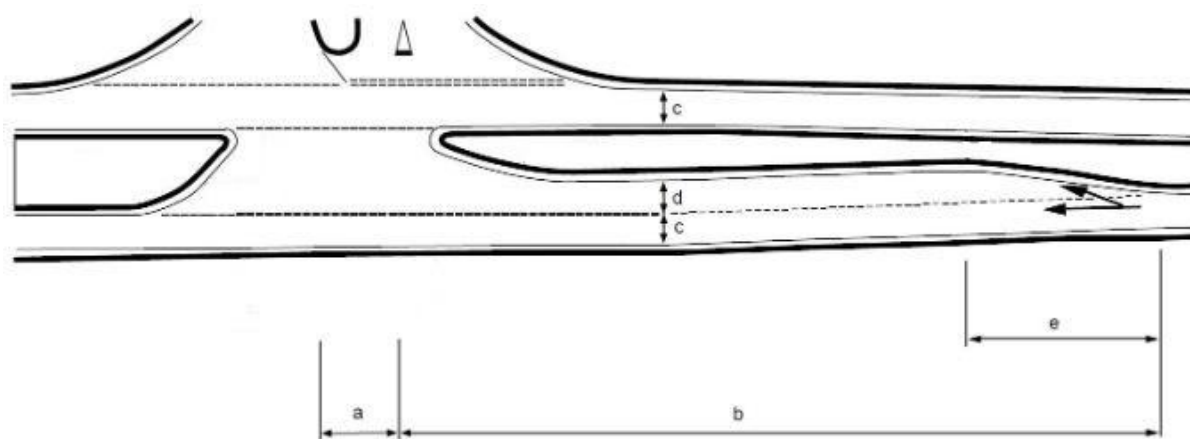
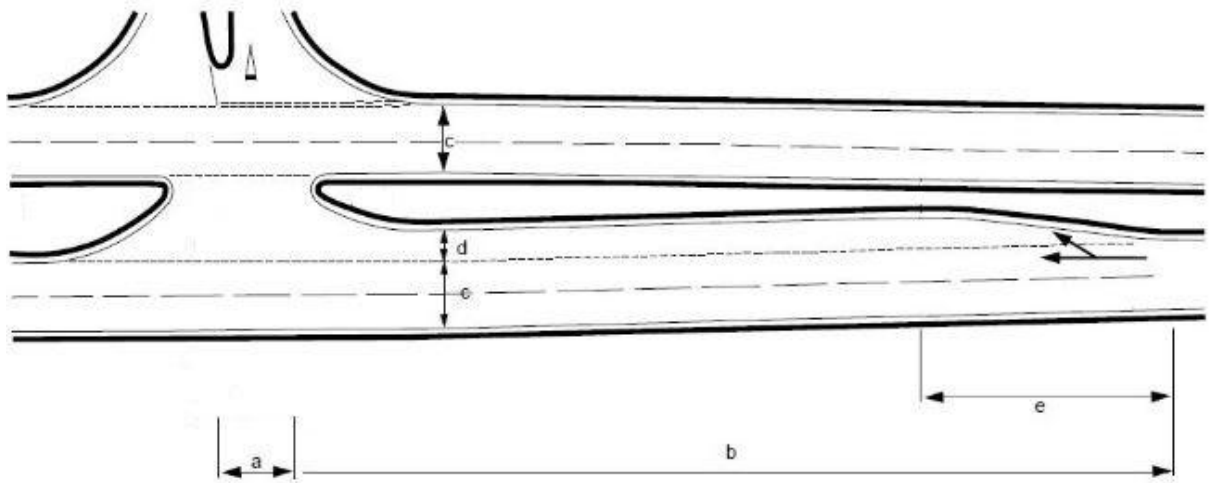

Figure 6.3e Dual carriageway major / minor priority junction



NOTE In Figures 6.3a to 6.3e the labelled dimensions are as indicated below:

- 1) a is the turning length (plus the queuing length, if required);
- 2) b is the deceleration length;
- 3) c is the through lane width;
- 4) d is the turning lane width; and,
- 5) e is the direct taper length.

6.3.1 The deceleration lengths at left/right staggered junctions on an SLD or dual carriageway may lie side by side.

6.4 The turning length shall be a minimum of 10 metres.

NOTE The turning length is provided to allow long vehicles to position themselves correctly for the right turn.

6.5 Where capacity calculations indicate that for significant periods of time there can be vehicles queuing to turn right from the major road, the turning length shall be increased to accommodate the forecast maximum queue length.

6.5.1 Where the turning length has been increased to the forecast queue length at a ghost island, physical islands should be provided within the hatched areas to provide greater protection to turning traffic.

6.6 For right turning lanes, the direct taper length and the minimum deceleration length shall be provided in accordance with Table 5.22.

6.6.1 The radii associated with the opening of the central reserve island for both SLD junctions (Figure 6.3d) and dual carriageway priority junctions (Figure 6.3e) should accommodate the turning movements of the largest vehicle type permitted to use the junction, such that overrunning of the physical islands are prevented.

Ghost islands

Through lane widths

6.7 At ghost island junctions on WS2+1 roads, the through lane widths in each direction shall be 3.5 metres, exclusive of hard strips.

6.8 At ghost island junctions on roads other than WS2+1 roads, the through lane widths in each direction shall be a minimum of 3.0 metres and a maximum of 3.65 metres wide, exclusive of hard strips.

6.8.1 At ghost island junctions on climbing lanes, the through lane widths in each direction should be 3.5 metres, exclusive of hard strips.

Island and right turning lane widths on WS2+1 roads

6.9 The width of the right turning lanes on WS2+1 roads shall be 4.5 metres.

NOTE A width of 4.5 metres is utilised to allow the 3.5 metre central lane width and 1 metre hatching to be continued through the junction.

Island and right turning lane widths on all roads except WS2+1

6.10 The minimum widths of right turning lanes (excluding those on WS2+1 roads), shall satisfy one of the following:

- 1) 3.5 metres; or,
- 2) 3.0 metres for new junctions; or,
- 3) 2.5 metres for improvements to existing junctions.

NOTE A narrow right turn lane down to 2.5m wide is only for improvements to existing junctions where space is limited and it is not possible to widen the carriageway cross section, e.g. in urban areas where the carriageway is bounded by buildings.

6.10.1 The widths of the right turning lanes should be in accordance with 1) for both new and existing junctions.

6.10.2 Where it is not feasible to provide the widths of the right turning lanes fully in accordance with 1), the widths should be as close to 1) as practicable, but no less than 2) or 3) depending on whether the junction is new or existing.

6.11 On urban roads the width of the right turning lane shall not exceed 5.0 metres.

NOTE Widths between 3.65 m and 5.0 m can be used on urban roads where it is considered necessary to provide a degree of shelter in the centre of the road for large goods vehicles turning out of the minor road to execute the turn in two separate manoeuvres.

6.11.1 On rural roads, with design speeds above 85 kph or where hard strips are present, the width of the right turning lane at new and existing junctions should not exceed 3.65 metres.

NOTE Lane widths greater than 3.65m are inadvisable on higher speed rural roads because wide ghost islands in these situations create a sense of space that can encourage hazardous overtaking at junctions.

6.12 At left/right staggered junctions, where the deceleration lengths have the potential to overlap, the width of the ghost island shall not be increased to make them lie side by side.

6.13 At left/right staggered junctions, where the deceleration lengths have the potential to overlap, the starting points of the right turn lanes shall be joined by a straight road marking, as shown in Figure 6.13.

Figure 6.13 Ghost island configuration at left/right staggered junction

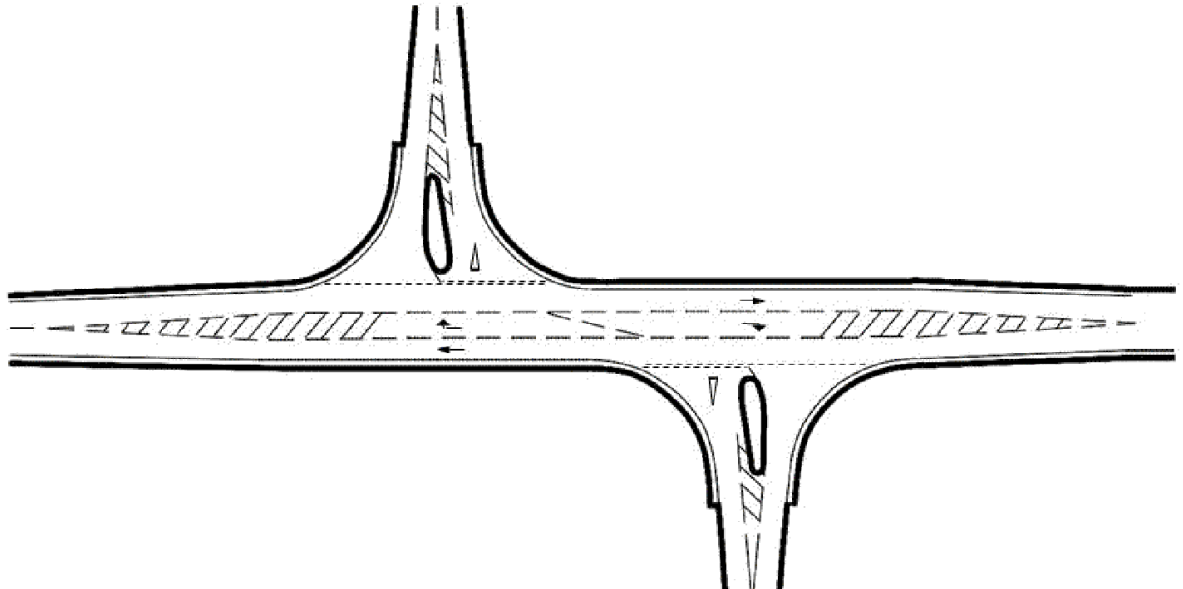

NOTE At higher design speeds, the full width of the turning lane on the ghost island is not developed until the end of the diverging section (as shown in Figure 6.13).

SLD and dual carriageway

Through lane widths

6.14 At SLD junctions, the through lane in each direction shall be 4.0 metres wide exclusive of hard strips.

NOTE A 4.0 metre width of the through lane with hard strips allows traffic to pass a stopped vehicle within the paved width.

6.15 At dual-carriageway junctions the through lane widths shall be the same as those either side of the junction.

NOTE For central reserve openings on dual carriageway, the requirements for the through lane cross-sections are provided in CD 127 [Ref 1.N].

Island and right turning lane dimensions

6.16 The width of the central reserve island (including hard strips) adjacent to the minor road (see Figure 6.16), shall be a minimum of:

- 1) 10 metres where the right turn out of the minor road is permitted; or,
- 2) 8.5 metres at new junctions where the right turn out of the minor road is prevented; or,
- 3) 8 metres at existing junctions where the right turn out of the minor road is prevented.

Figure 6.16 Major / minor priority junctions with SLD

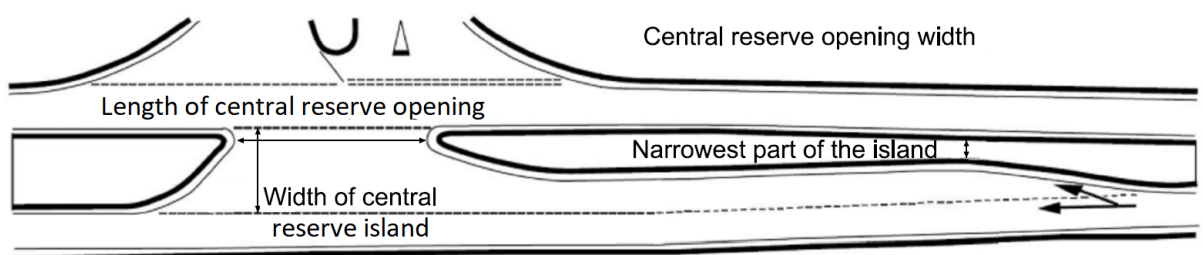

6.16.1 Where use by long vehicles is expected at junctions where the right turn out of the minor road is permitted, the width of the central island adjacent to the minor road should be 14.0 metres or 16.5 metres (including central reserve hard strips) to accommodate the design vehicle and drawbar trailer vehicle respectively.

6.17 The minimum width of any part of an SLD or central reserve island shall be 3.5 metres.

NOTE The narrowest part of the physical island is usually located at the end of the direct taper, (shown in Figure 6.16).

6.18 The length of central reserve opening (excluding hard strips) adjacent to the minor road (see Figure 6.16) shall be

- 1) 15.0 metres where the right turn out of the minor road is permitted; or,
- 2) a minimum of 8.0 metres where the right turn out of the minor road is prevented.

6.18.1 The length of the central reserve opening at junctions where the right turn out of the minor road is prevented should be increased over the minimum if site-specific swept vehicle path analysis using the largest vehicle permitted to use the junction indicates that this is necessary.

NOTE Increasing the amount of overlap of the physical islands will further discourage road users from attempting to turn right out of the minor road where this movement is prevented.

6.18.2 Sections in the central reserve opening at SLD and dual carriageway junctions should fall towards, rather than away, from the minor road.

NOTE 1 The carriageway falling towards, rather than away, from a minor road is particularly important where there is super-elevation across the main carriageway.

NOTE 2 Where the carriageway does not fall towards the minor road at a central reserve opening, drivers can potentially:

- 1) fail to see the full width of the furthest carriageway from their position on the minor road;
- 2) not immediately appreciate the road they are joining is a dual carriageway (particularly with SLD); or,
- 3) attempt to perform the right turn out of the minor road in one stage (by thinking that the width available in the central reserve appears insufficient to accommodate waiting vehicles).

6.19 Where the right turn out of the minor road is prevented, a minimum of 3 metres overlap between the minor road central island and the mainline central reserve (as illustrated in Figure 6.19) shall be provided.

Figure 6.19 Overlap between physical islands at SLD and dual carriageway priority junctions where the right turn out of the minor road is prevented.

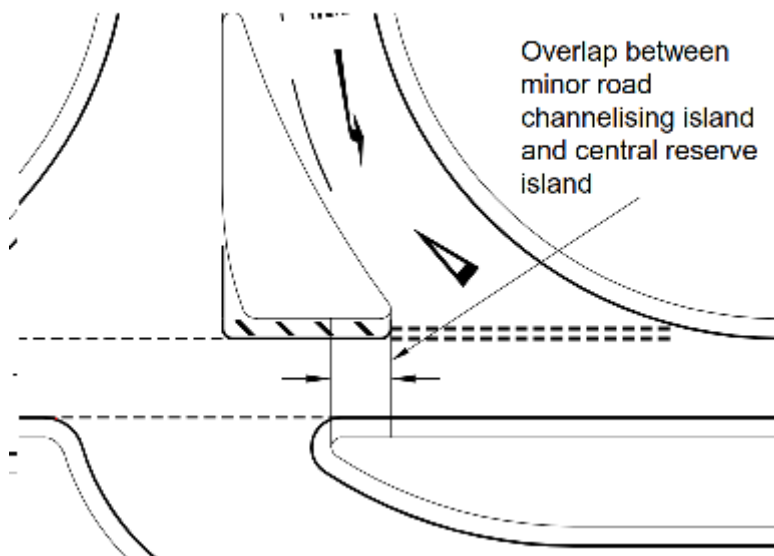

6.20 Where deceleration lengths at left/right staggered junctions on an SLD or dual carriageway lie side by side, a physical island shall be provided to separate them, as illustrated in Figures 6.20a and 6.20b.

Figure 6.20a SLD configuration at left/right staggered junction

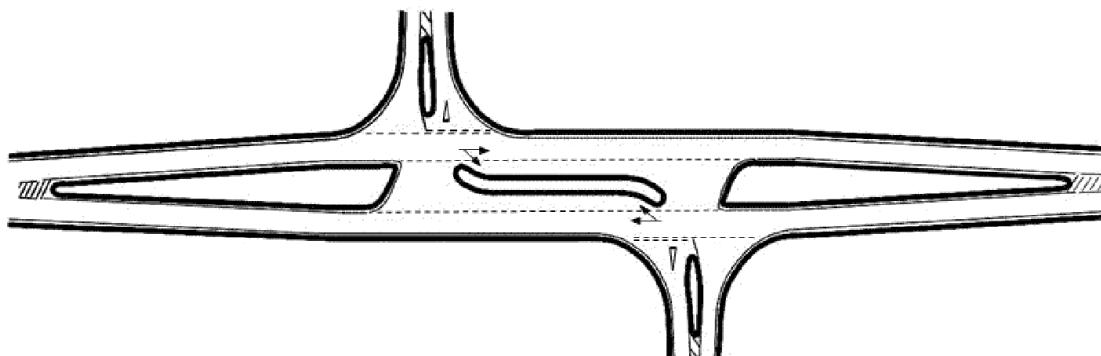
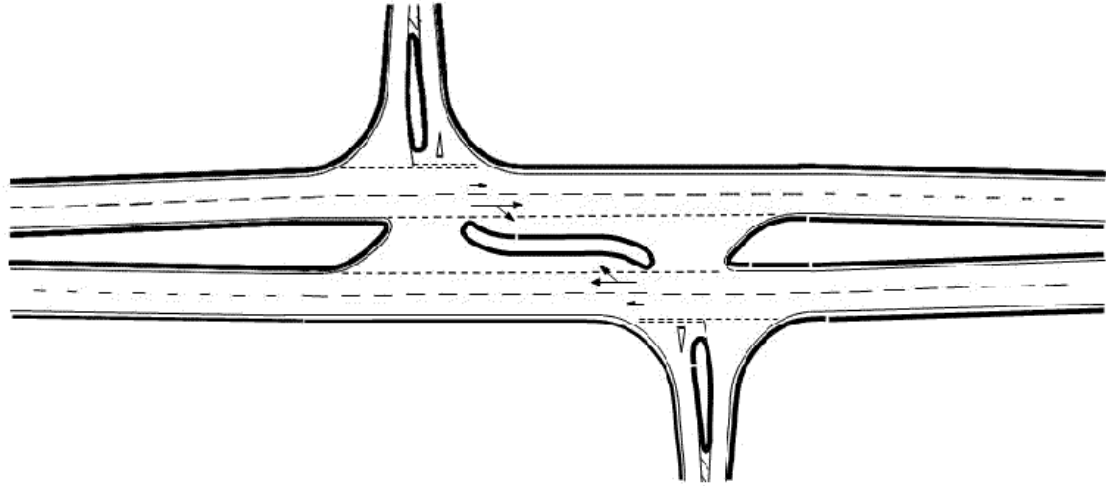

Figure 6.20b Dual carriageway configuration at left/right staggered junction



Physical central reserve layout on WS2+1

Through lane widths

6.21 The through lane in each direction shall be 3.5 metres wide with a 1 metre wide nearside hard strip, as illustrated in Figure 6.21.

Figure 6.21 Through lane and island widths on dualled sections of WS2+1 roads

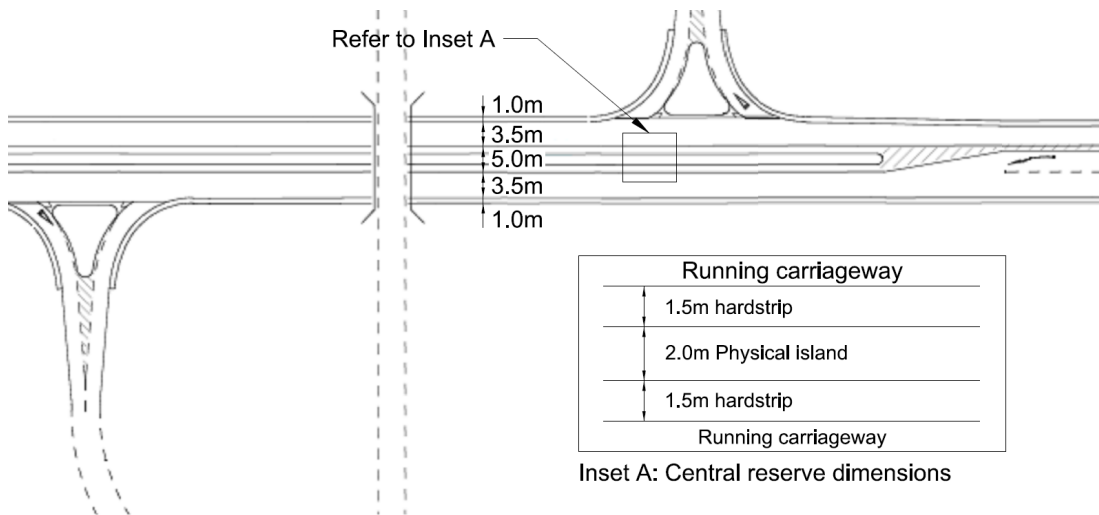

NOTE The central reserve is formed by terminating the overtaking lane section prior to the junction, so that one 3.5 metre lane runs in each direction through the junction.

Central island layout

6.22 The central island shall be introduced by means of hatched road markings over a taper of 130 metres as illustrated in Figure 6.22.

Figure 6.22 Introduction of dualling at grade separated junctions on WS2+1 road

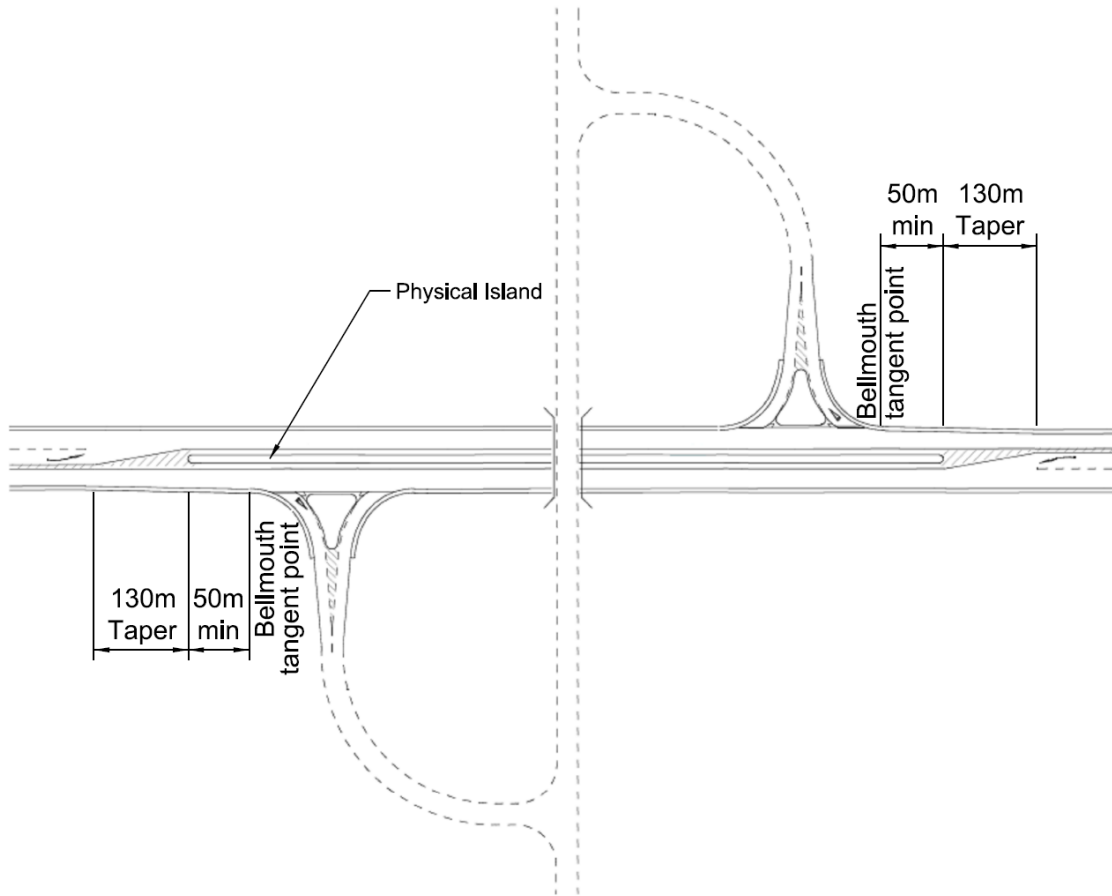

- 6.23 The central island shall be 5 metres wide, made up of a 2-metre physical island and 1.5-metre hard strips either side.
- 6.24 The central reserve shall extend a minimum of 50 metres at each end, measured from the end of the nearside radius of the minor road entry lanes, to prevent right turns.
- 6.24.1 The central reserve may be extended further than 50 metres at either end to further reduce the risk of right turns and/or u-turns.

Passing bays

- 6.25 Dimensions for passing bays shall be based on swept path analysis and the number and size of vehicles expected to be waiting to turn right at a given time.

NOTE 1 Passing bays allow through vehicles to pass vehicles waiting to turn right in the centre of the major road, albeit at a reduced speed.

NOTE 2 Figure 6.25N2 and Table 6.25N2 provide typical dimensions for passing bays to accommodate different combinations of waiting vehicles where the major and minor road are both nominally 7.3 metres wide.

Table 6.25N2 Geometric parameters for a passing bay

Expected vehicles	Dimensions (metres)				
	P1	P2	P3	P4	P5
Car and car	18.8	13.0	10.9	5.0	0.8
Car and HGV	28.7	18.5	15.2	5.0	1.35
HGV and HGV	30.5	33.2	15.2	5.0	2.8

Figure 6.25N2 Passing bay dimensions

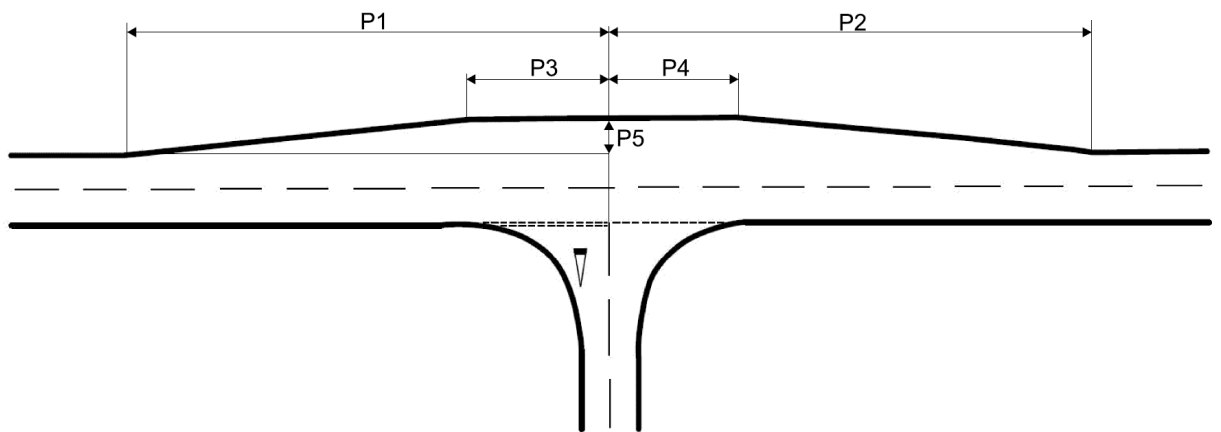

7. Geometric design of signal-controlled junctions

Junction intersection

- 7.1 At new signal controlled junctions, the minimum intersection angle of the roads (refer to Figure 7.1.2) shall satisfy one of the following:
 - 1) 90 degrees; or,
 - 2) a minimum of 70 degrees.
- 7.1.1 The intersection angle of the roads should be in accordance with 1).
- 7.1.2 Where it is not feasible to provide an intersection angle fully in accordance with 1), the angle should be as close to 1) as practicable, but no less than 2).

Figure 7.1.2 Intersection angle of roads forming a signal controlled junction

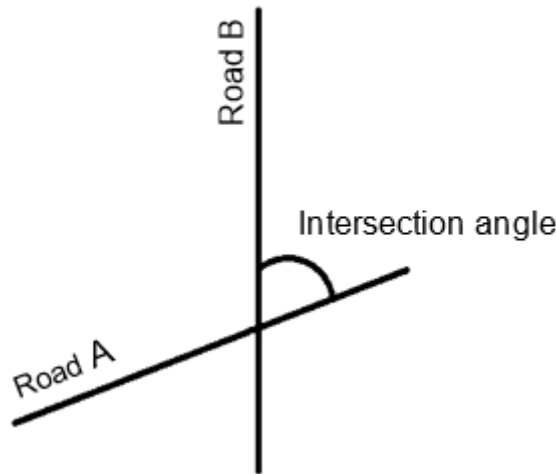

NOTE *Intersection angles of less than 70 degrees can cause problems with driver comprehension of the junction, intervisibility, tight turning manoeuvres and turning speeds.*

Visibility at signal-controlled junctions

Visibility of signals

- 7.2 Each traffic lane shall have clear visibility of at least one primary signal associated with its particular movement, from a distance equivalent to the desirable minimum SSD of the approach road.
 - 7.2.1 Duplicate primary signals should be provided on approaches with a speed of 85 kph or above.
- 7.3 Visibility to the primary signal shall be in accordance with the CD 109 [Ref 5.N] visibility envelope, but with the high object height amended to incorporate the signal head where this exceeds 2 metres, as indicated in Figure 7.3.

Figure 7.3 Visibility requirements on approach to junction

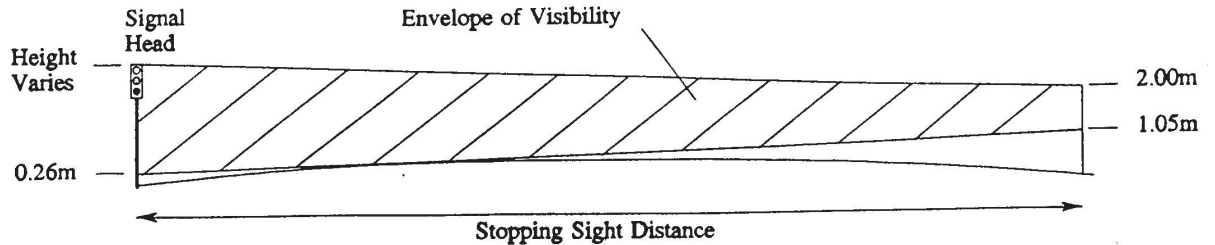

- 7.3.1 Where multiple lanes are provided on the approach, a signal-controlled junction may have offside primary, double-headed or overhead additional signals to ensure visibility of the signals from all lanes.
- 7.3.2 A minimum of 2 signals should be visible from each approach arm and each stop-line.
- NOTE The 2 signals usually comprise a primary and a secondary signal.*
- 7.3.3 Additional signal heads may be provided where a driver's vision of the signal head could be obscured (for example by a lorry in the lane adjacent to the signal).
- 7.3.4 Where separate signalling of turning movements is employed, a minimum of 2 signals should be visible from each approach lane associated with each of the turning movements and each associated stop-line.
- NOTE Where separate signalling of turning movements is employed, a signal post can then display information applicable to more than one turning movement.*
- 7.3.5 Primary signal heads should be located a minimum of 1 metre beyond the stop-line.
- 7.3.6 Primary signal heads should be located in advance of crossing studs or marks if pedestrian facilities are provided.
- 7.3.7 At junctions with angled approaches, the secondary signal should be displaced a maximum angle of 30° from the driver's line of forward sight, as indicated in Figure 7.3.7.

Figure 7.3.7 Locating secondary signals

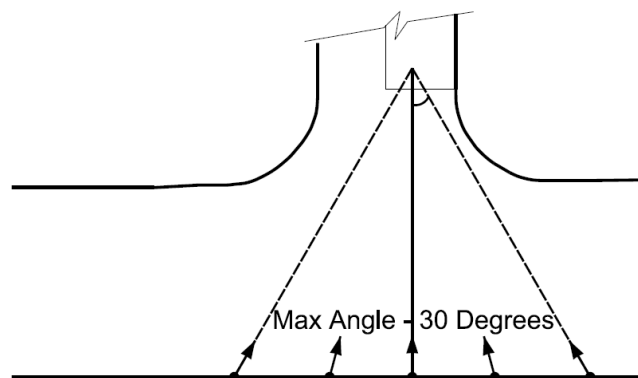

- 7.3.8 The distance between the stop-line and an associated secondary signal should not exceed 50 metres.
- 7.3.9 Where multi-phased signal layouts are provided, an additional secondary signal may be utilised.
- NOTE Multi-phased signal layouts can result in "see through" where road users (at point X) could be confused by the signal at the next stop-line (point Y), as indicated in Figure 7.3.9N where a displaced pedestrian crossing is illustrated. In these situations, an additional secondary signal can aid driver understanding.*

Figure 7.3.9N Example of a small signal-controlled T-junction multi-phased signal layout

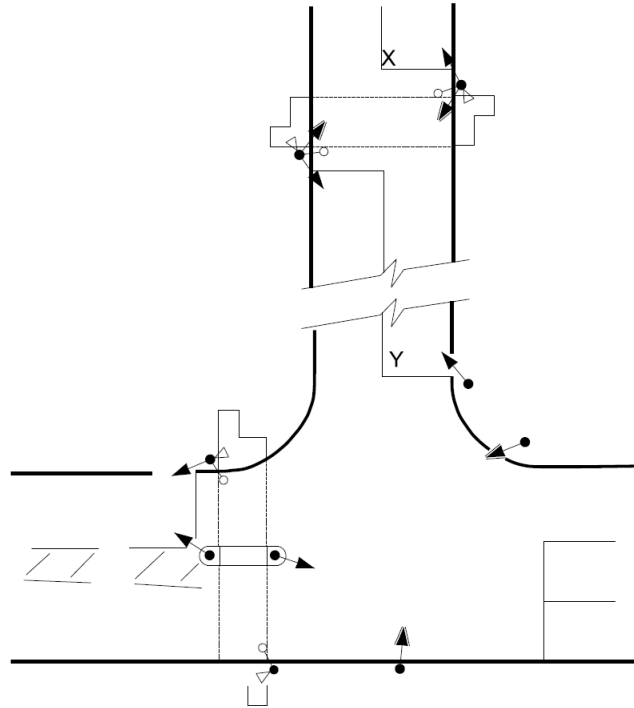

7.3.10 The desirable minimum SSD should be provided to the back of the queue.

NOTE The back of the queue could be in excess of the immediate approach to the junction as defined in CD 109 [Ref 5.N].

Junction intervisibility zone

7.4 An intervisibility zone shall be provided that incorporates an area that extends across the full carriageway width of each arm from a distance of 2.5 metres back from each stop line, as illustrated in Figure 7.4.

Figure 7.4 Junction intervisibility zone (without crossings)

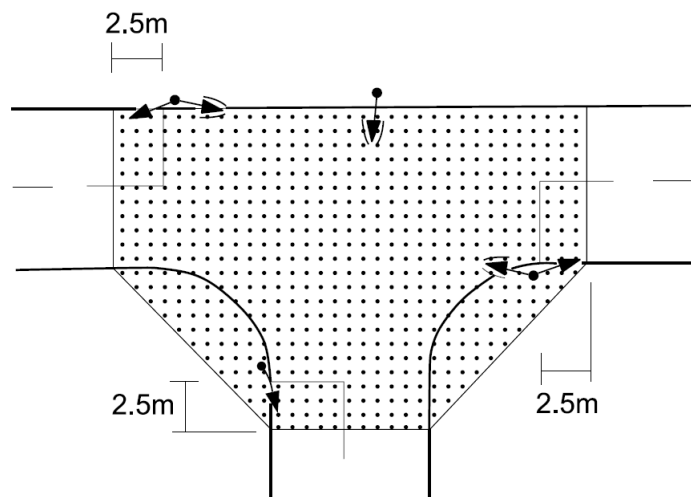

- 7.5 Where an advance stop-line (ASL) is provided, the intervisibility zone shall be measured from a point 2.5 m behind the cyclists' stop-line.
- 7.5.1 Where a staggered pedestrian crossing is provided, the section of the crossing immediately adjacent to the junction should be included in the junction intervisibility zone.
- NOTE* *The junction intervisibility zone does not need to be extended to incorporate a crossing facility that is remote from the junction and operates independently of the junction.*
- 7.6 No substantial fixed obstructions shall be located within the intervisibility zone of new junctions.
- NOTE* *Details of what constitutes a substantial fixed obstruction are provided in CD 109 [Ref 5.N].*
- 7.6.1 No substantial fixed obstructions should be located within the intervisibility zone of existing junctions.

Entry lanes, exit lanes and storage capacity

Lane widths

- 7.7 At new junctions, the minimum width of straight ahead lanes shall be 3.0 metres.
- 7.8 At existing junctions, the minimum width of straight ahead lanes shall satisfy one of the following:
- 1) 3.0 metres; or,
 - 2) 2.5 metres where the 85th percentile approach speed exceeds 56 kph (35 mph) and/or it is necessary to make provision for HGVs; or,
 - 3) 2.25 metres where the 85th percentile approach speed does not exceed 56 kph (35 mph) and it is not necessary to make provision for HGVs.
- NOTE* *Existing junctions can be an existing signal-controlled junction or an existing priority junction being upgraded.*
- 7.8.1 The minimum width of the straight ahead lanes should be in accordance with 1) for all situations.
- 7.8.2 At existing junctions, straight ahead lanes should only be reduced to 2.5m or less, if this allows the total number of lanes to be increased.
- 7.8.3 Straight ahead lanes should be a maximum of 3.65 metres wide at both new and existing junctions.
- 7.8.4 A minimum width of 4.0 metres should be provided between physical islands where cycle demand indicates a need.
- 7.9 Dedicated lanes for left or right turning traffic shall be a minimum of 3.0 metres wide.
- NOTE 1* *Junction capacity can be increased by widening the road in the vicinity of the junction to provide dedicated left or right turn lanes.*
- NOTE 2* *Vehicles in dedicated turning lanes can often move independently to those in other lanes and therefore lane widths greater than 3 metres are often necessary to allow for this.*
- 7.10 Dedicated lanes for left-or right-turning traffic shall be developed with tapers of 1 in 5, as illustrated in Figure 7.10.

Figure 7.10 Dedicated turning lane arrangement for a left-turn approach lane

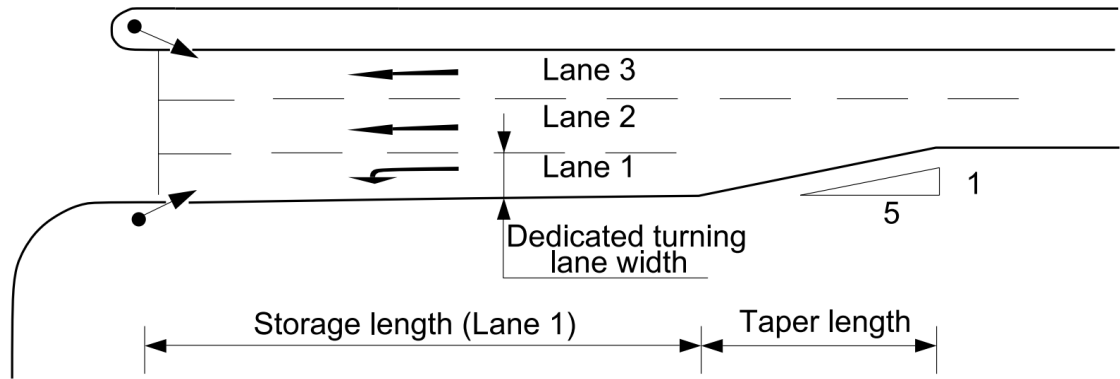

- 7.10.1 On single carriageway roads, right-turn entry lanes may be accommodated by the provision of a hatched island, as illustrated in Figure 7.10.2.
- 7.10.2 On single carriageway roads, hatched islands for right-turn lanes should be developed symmetrically from the centre line of the road with a minimum taper of 1 in 10 and a direct taper of 7.5 metres, as illustrated in Figure 7.10.2.

Figure 7.10.2 Right turn lane hatched island layout

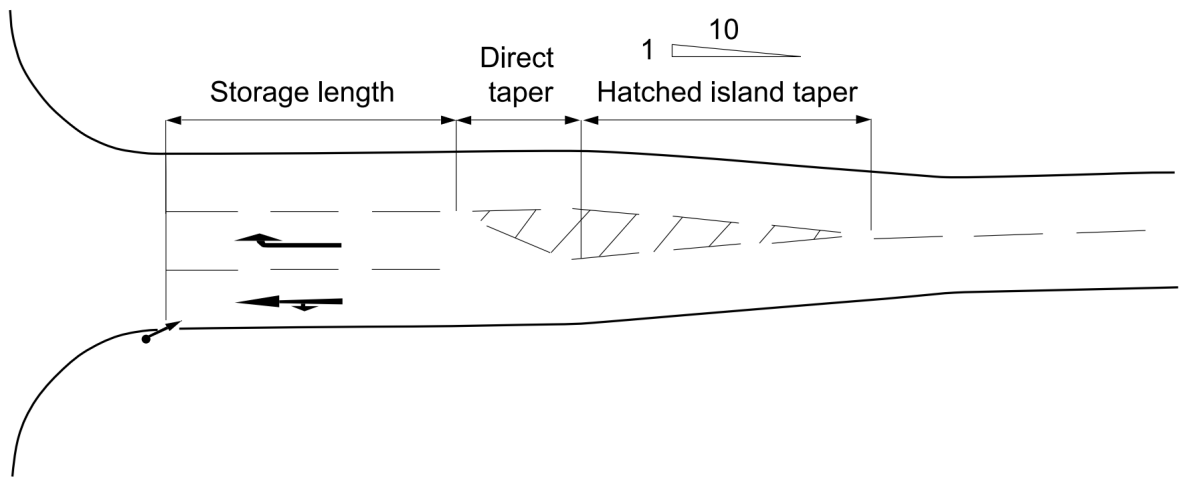

Storage length

- 7.11 The storage length shall be measured from the stop line to the furthest point upstream where the total number of entry lanes are at full width, as illustrated in Figure 7.10.2.
- 7.11.1 The storage length of the left- and right-turn entry lanes should be designed:
 - 1) to meet the capacity requirements of the junction;
 - 2) to accommodate the longest queue of stopped traffic (to avoid turning traffic blocking the adjacent lane); and,
 - 3) to avoid traffic being prevented from entering the left- or right-turn lane where there is a high proportion of straight ahead traffic queuing in the adjacent lane.

Exit lane continuity

- 7.12 Where it is necessary to reduce the numbers of lanes on an exit, this shall be carried out on either the nearside or the offside depending on the prevailing traffic flows on the exit arm.
- 7.12.1 Where it is necessary to reduce the number of lanes on the exit arm, a single lane should be reduced over a distance of 100 metres starting at or beyond the limit of the junction intervisibility zone, as illustrated in Figure 7.12.1.

Figure 7.12.1 Lane continuity through junction intervisibility zone

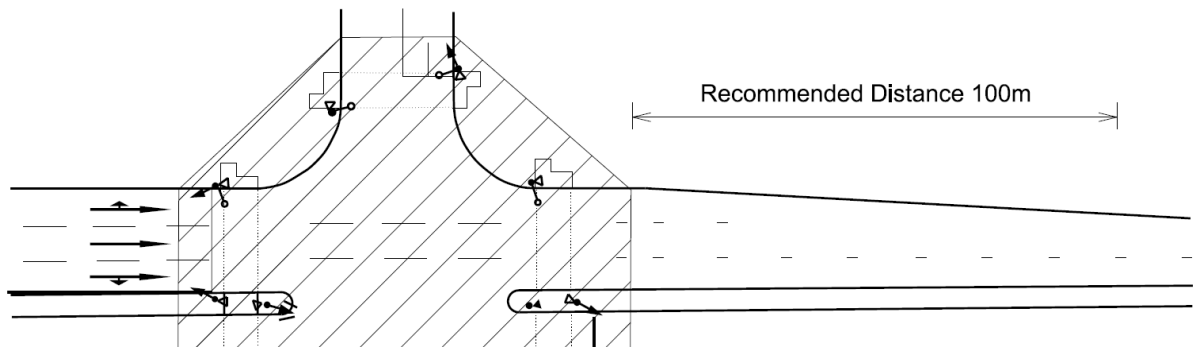

NOTE *The use of lane markings within the junction intervisibility zone, can be beneficial to direct traffic streams and reduce conflict where entry- and exit-lane widths vary or the alignment through the junction is not a direct path.*

Other geometrical elements of signal-controlled junctions

Swept path and corner radii

- 7.13 The design of a signal-controlled junction shall allow for the swept turning paths of the design vehicle where provision is to be made for large goods vehicles.
- 7.13.1 The design of a signal-controlled junction should incorporate turning radii to cater for the swept paths of the worst case vehicle that can be reasonably expected to use the junction on a frequent basis.

NOTE *The worst case vehicle is the vehicle that has the most onerous swept path.*

- 7.14 Where provision is to be made for large goods vehicles, the values for corner radii and associated tapers shall be the same as for a priority junction (refer to Section 5).
- 7.14.1 Where no provision is to be made for large goods vehicles, the minimum corner radii should be the same as for a priority junctions (refer to Section 5).

NOTE 1 *Where the layout of a signal controlled junction has not generally be designed to cater for large goods vehicles, these vehicles can have difficulty in completing a manoeuvre without encroaching into opposing lanes. In such situations, stop-lines (and crossings if present) can be set back to beyond where such a conflict would occur. This is illustrated in Figure 7.14.2N1.*

Figure 7.14.1N1 Setting back stop-lines

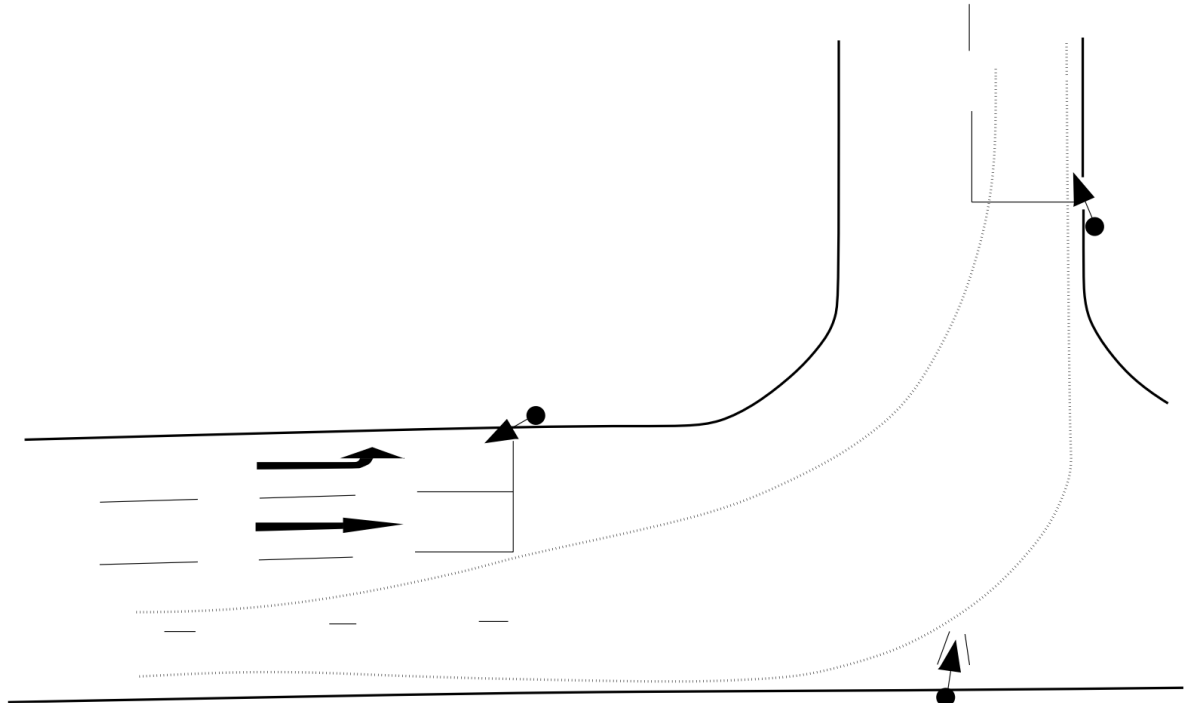

NOTE 2 When offsetting stop lines as illustrated in Figure 7.14.2N, the junction intervisibility zone will need to be enlarged to suit.

7.14.2 Stop-lines on adjacent entry lanes should not be staggered.

NOTE At staggered stop-lines, large goods vehicles in the nearside entry lane can prevent vehicles in the offside entry lane seeing the nearside primary signal or pedestrians.

Traffic islands (including at left-turn slips)

7.15 The nosing of central reserves and pedestrian refuges shall be set back a minimum distance of 1.5 metres from the edge of carriageway of the intersecting road.

7.15.1 Pedestrian crossings and any associated refuges should be located beyond the limits of the junction radii to minimise crossing distance.

7.16 A minimum clearance of 450 mm shall be provided between the edge of carriageway and any street furniture.

NOTE It can be necessary to provide additional clearance between the edge of carriageway and any street furniture where the carriageway crossfall is greater than 2.5%

7.17 Traffic islands shall be provided to separate uncontrolled traffic from controlled traffic where left-turn slip lanes are provided.

7.17.1 Traffic islands may be provided to separate two independently controlled lanes of traffic on the same entry.

7.17.2 Left-turn slip lanes may be signal-controlled or uncontrolled.

7.17.3 A left-turn slip lane should be provided where:

- 1) the left-turn traffic movement is high;
- 2) left-turn manoeuvres for large goods vehicles need to be facilitated;
- 3) delay for left-turn vehicles would otherwise be significant;

4) left-turn traffic capacity requirements would extend the green time required for the straight ahead traffic movement phase.

7.17.4 A single pedestrian crossing route through a signal-controlled junction should not include a mix of controlled and uncontrolled crossing points.

NOTE 1 *Pedestrian crossings at uncontrolled left-turn slip lanes can be particularly hazardous due to the potential for higher traffic speeds at these locations. When deciding to site crossings at uncontrolled left-turn slips, it is important to consider the:*

- 1) *visibility levels between pedestrians and approaching traffic; and,*
- 2) *availability of suitable gaps in traffic flow for pedestrians to cross.*

NOTE 2 *Further design requirements for pedestrian crossings on segregated left-turn lanes are provided in CD 116 [Ref 1.I].*

NOTE 3 *Traffic islands can assist in providing safe crossings for pedestrians whilst improving traffic capacity by the incorporation of pedestrian call stages.*

NOTE 4 *Design requirements for pedestrian refuges are provided in CD 143 [Ref 3.N].*

Right-turning traffic movements

7.18 On roads with a design speed of 85 kph or higher, right turning lane(s) shall be separately signalled and segregated from the adjacent ahead-only lane(s) by a traffic island.

NOTE *Where opposing right turn lanes can be aligned directly opposite each other, layouts that encourage traffic to pass in front rather than behind each other can be used to improve traffic flow. They can also allow a small number of right turning vehicles to wait within the junction intervisibility zone. This is illustrated in Figures 7.18Na and 7.18Nb.*

Figure 7.18Na Aligned non-hooking arrangement

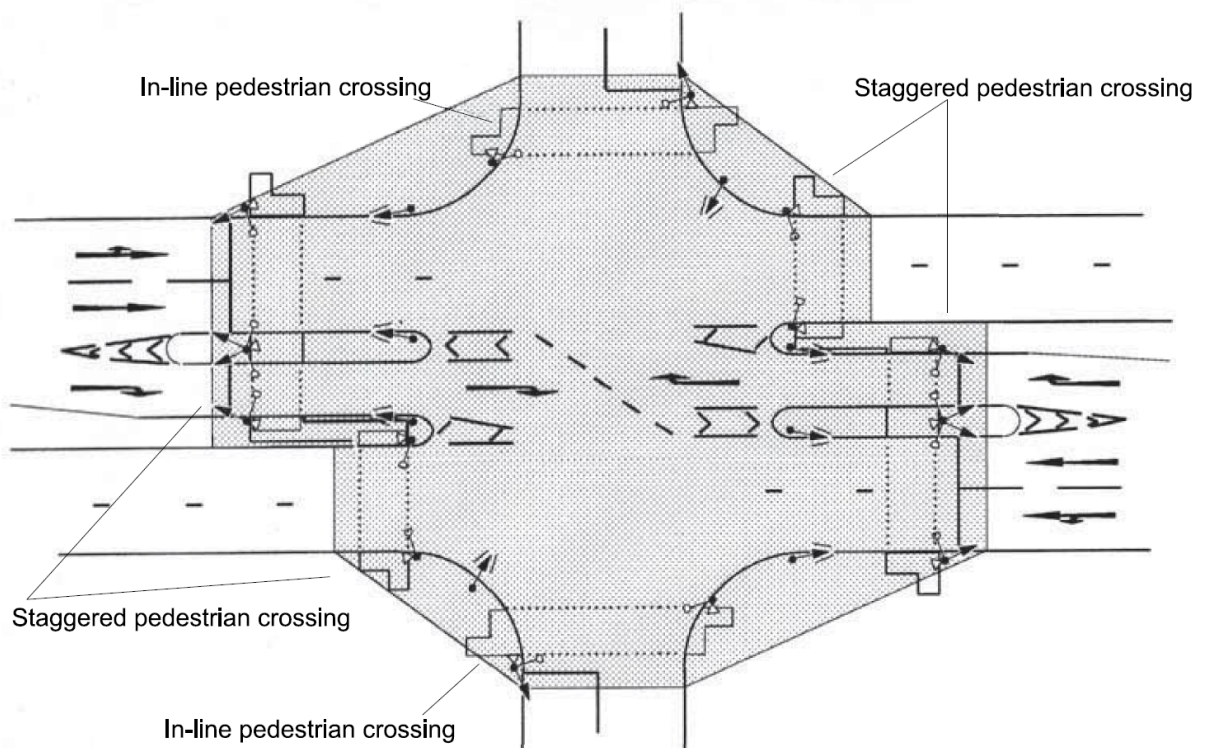
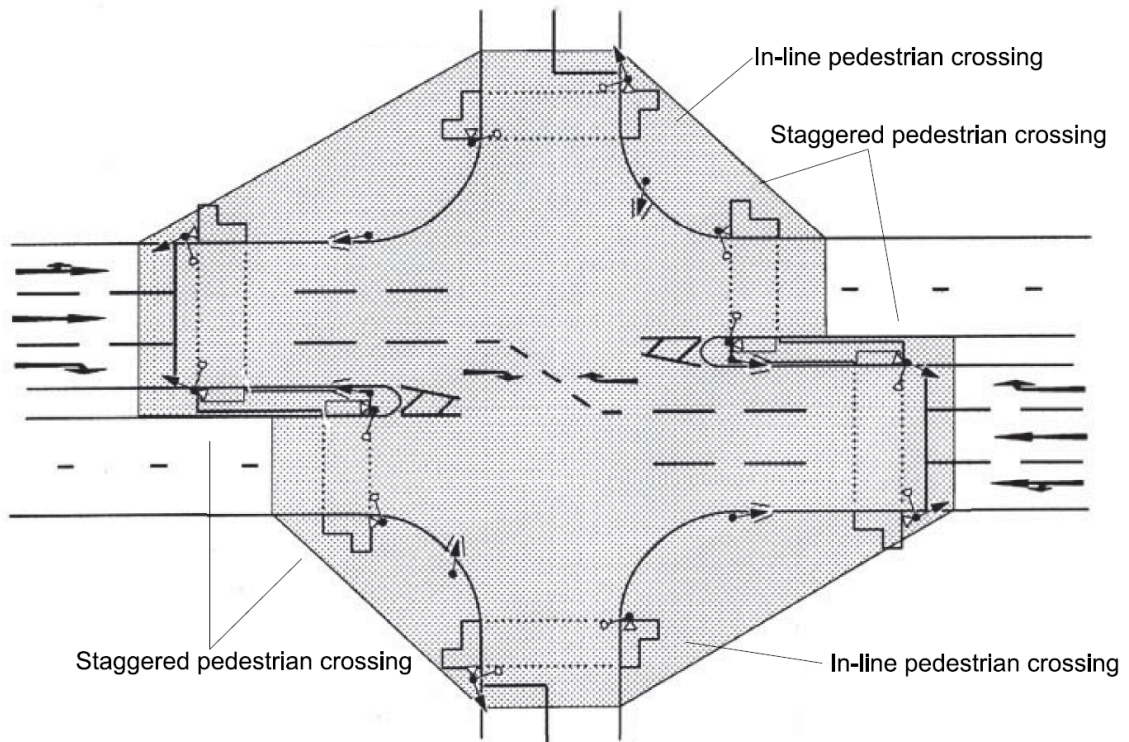

Figure 7.18Nb Offset non-hooking arrangement



7.18.1 The central reserves on the major road may be offset to encourage right turning traffic to pass in front rather than behind each other. This is illustrated in Figure 7.18Nb.

NOTE *The inclusion of a separation island as part of a right turning arrangement that encourages traffic to pass in front rather than behind each other can be useful to deflect traffic where the two arms are offset from each other. This is illustrated in Figure 7.18.1N.*

Figure 7.18.1N Example of existing signal-controlled junction subject to design constraints

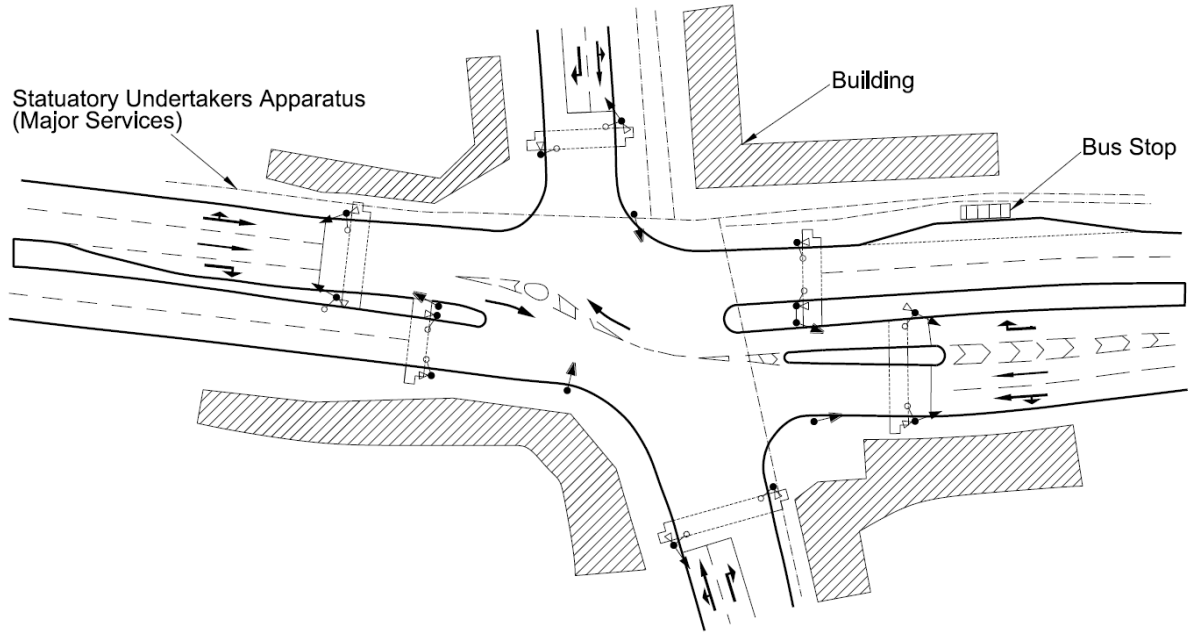

7.18.2 Where the 85th percentile approach speed is greater than 72 kph (45 mph), right-turns should be separately signalled.

NOTE *Where the 85th percentile approach speed is greater than 72 kph (45 mph), there is an increased risk of accidents between right-turning vehicles seeking gaps and on-coming vehicles travelling at speed.*

Location of controller cabinets

7.19 The controller cabinet shall not be situated such that it causes either physical or visual obstruction to road users and pedestrians.

7.19.1 The controller cabinet should be positioned to allow visibility from the controller cabinet to the signal head and stop-line for each junction arm.

NOTE *Access and parking arrangements for the servicing of the signal equipment form part of the junction layout design.*

8. Normative references

The following documents, in whole or in part, are normative references for this document and are indispensable for its application. For dated references, only the edition cited applies. For undated references, the latest edition of the referenced document (including any amendments) applies.

Ref 1.N	Highways England. CD 127, 'Cross-sections and headrooms'
Ref 2.N	Highways England. CD 195, 'Designing for cycle traffic'
Ref 3.N	Highways England. CD 143, 'Designing for walking, cycling and horse riding (vulnerable users)'
Ref 4.N	National Highways. CD 122, 'Geometric design of grade separated junctions'
Ref 5.N	Highways England. CD 109, 'Highway link design'
Ref 6.N	National Highways. GG 101, 'Introduction to the Design Manual for Roads and Bridges'

9. Informative references

The following documents are informative references for this document and provide supporting information.

Ref 1.l	Highways England. CD 116, 'Geometric design of roundabouts'
Ref 2.l	The National Archives. HM Government. ISBN 9781 1 914124 02 0, 'The Building Regulations 2010, Fire Safety - Approved Document B - Volume 1 - Dwellings'
Ref 3.l	Highways England. CD 169, 'The design of lay-bys, maintenance hardstandings, rest areas, service areas and observation platforms'

Appendix A. Examples of signal-controlled junction layouts and impact on signal operation

A1 Opposing right turns at signal-controlled junctions

Collisions at signal-controlled junctions can occur as a result of conflicts arising from right turning traffic movements. To mitigate this risk, opposing right turns should run separate phases or with a late start wherever the signal timings, junction capacity and geometric layout can facilitate this.

A2 Signal-controlled T-junctions

A2.1 Small urban signal controlled T-junction

Figure A.1 illustrates a simple, small urban signal-controlled T-junction, typical of a situation where available road space is restricted and usage by large goods vehicles is expected to be low.

For the purpose of this example, it is assumed that the low pedestrian movements combined with the necessity to provide a right turn from Arm C to Arm B have led to a decision not to provide a pedestrian crossing on Arm C.

The following specific design features are incorporated into the example:

- 1) circular corner radii without tapers (no provision for swept paths of large goods vehicles);
- 2) a 'displaced' pedestrian crossing on Arm B linked to the junction signals; and
- 3) an in-line pedestrian crossing on Arm A.

Figure A.1 Example of a small signal-controlled T-junction

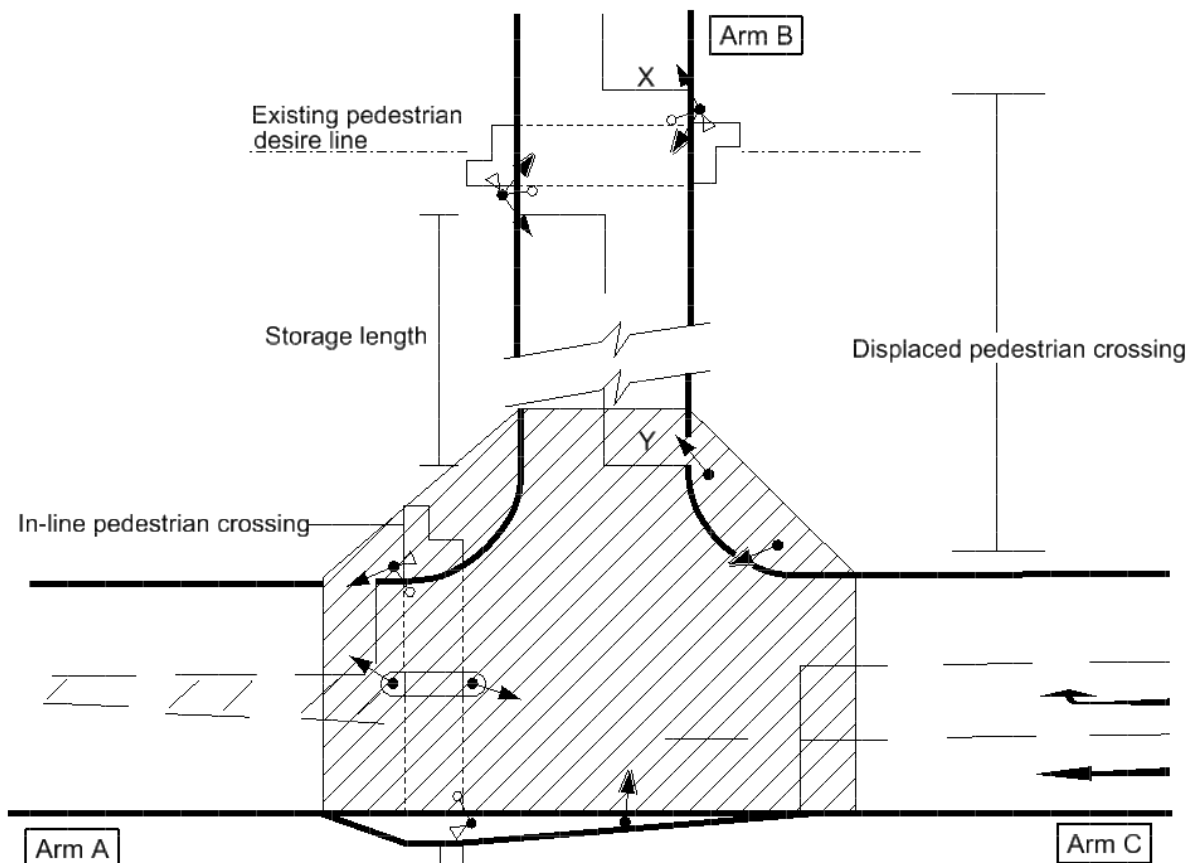

A2.2 Large urban or larger rural signal-controlled T-junction

Figure A.2 indicates an example of a large urban or larger rural signal-controlled T-junction between two dual carriageways, typical of a situation where available road space is not severely restricted, and a significant proportion of large goods vehicles is anticipated on all arms. It is assumed that a pedestrian crossing cannot be provided on Arm A due to localised physical constraints.

The following specific design features are incorporated into the example:

- 1) signal-controlled left turn slip lanes and separation islands (Arm A to B and B to C);
- 2) larger corner radii with tapers (provision for swept paths of large goods vehicles);
- 3) all staggered pedestrian crossings are indicated in the preferred orientation; and
- 4) road markings provided to channelise traffic.

Figure A.2 Example of a large signal-controlled T-junction

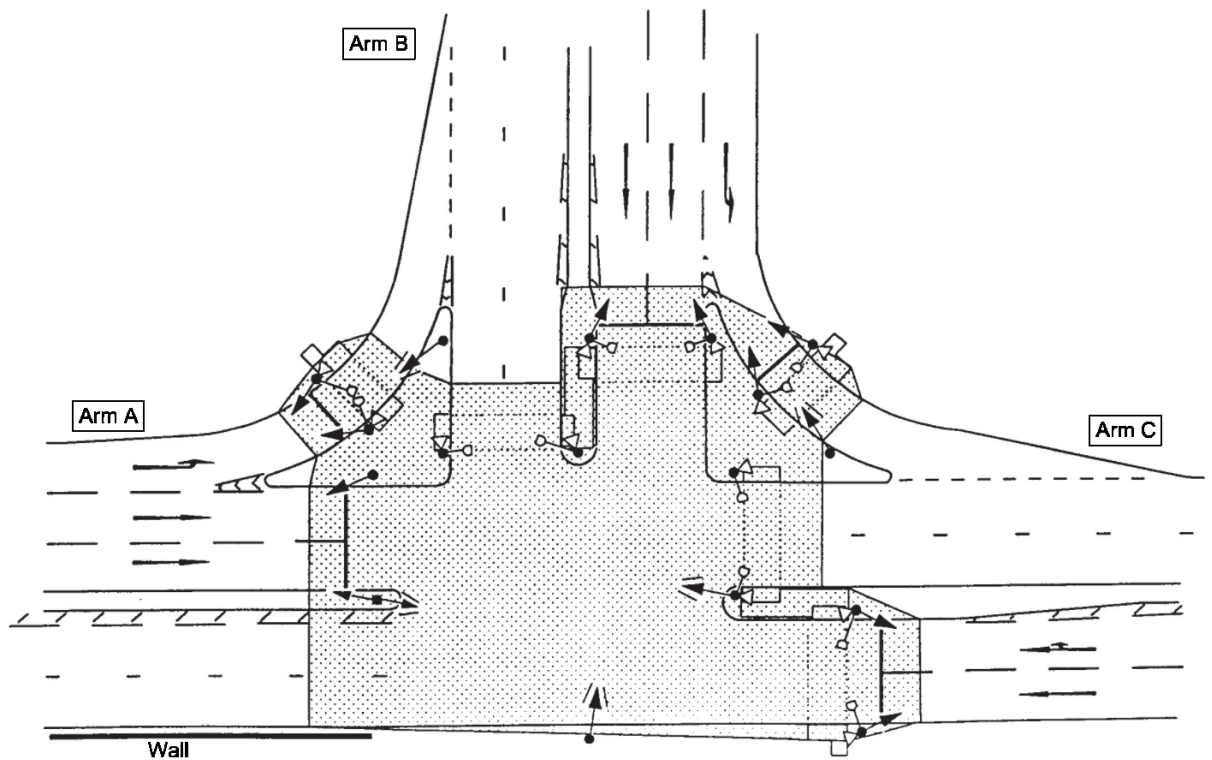

A3 Signal-controlled crossroads

A3.1 Urban signal-controlled crossroads

Figure A.3 illustrates an example of an urban signal-controlled crossroads, typical of a situation where available road space is restricted but there is sufficient width to provide a localised central reserve on the major road. The presence of large goods vehicles in significant proportions is not expected and the major road is an important bus route. The following design features are incorporated into the example:

- 1) localised widening on the major road to facilitate a staggered pedestrian crossing facility;
- 2) circular corner radii without tapers (no provision for large goods vehicles); and
- 3) bus lane discontinued on approach to junction (Arm A).

In Figure A.3, the bus lane has been terminated in advance of the junction intervisibility zone and the associated pedestrian crossing. In this example, the staggered pedestrian crossing, which is part of the junction signal operation, is not in the preferred orientation.

Figure A.3 Example of a signal-controlled crossroads with a staggered pedestrian crossing

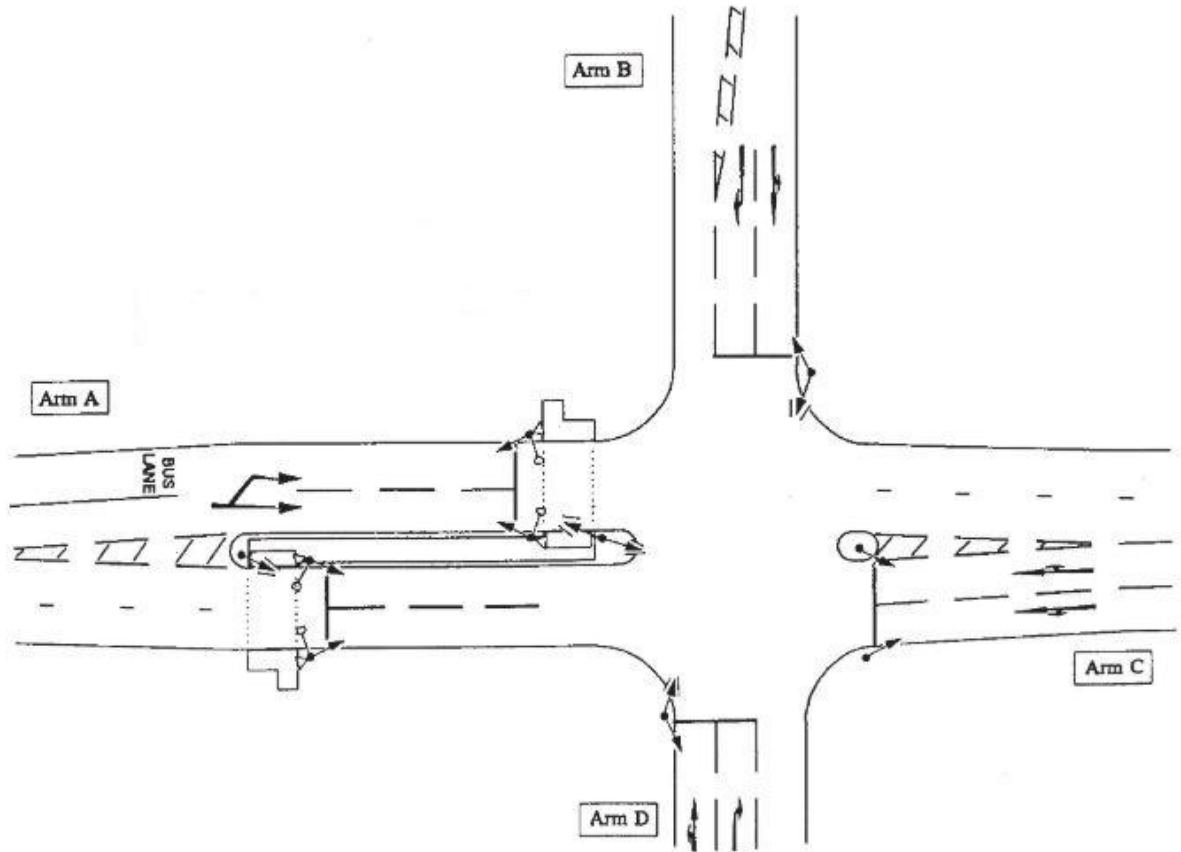

A3.2 Complex urban / rural signal-controlled crossroads

Figure A.4 illustrates an example of a larger, more complex urban or rural signal-controlled crossroad junction between two major dual carriageways. This example is intended to illustrate a situation where, although available road space is not generally restricted, there are some physical constraints which impose limitations on the turning provisions, junction intervisibility and the orientation of the staggered pedestrian crossings. The following design features are incorporated into the example:

- 1) uncontrolled left turn slip lane (A to B);
- 2) circular radius without tapers (Arm B to C);
- 3) controlled left turn slip lane (C to D);
- 4) left turn ban (Arm D to A);
- 5) due to the constraints imposed by the separation island, the staggered pedestrian crossing on Arm C is not in the preferred orientation; and
- 6) the staggered pedestrian crossing on Arm D is in the preferred orientation.

In Figure A.4, the left turn from Arm D to Arm A is prohibited.

Figure A.4 Example of a large signal-controlled crossroad

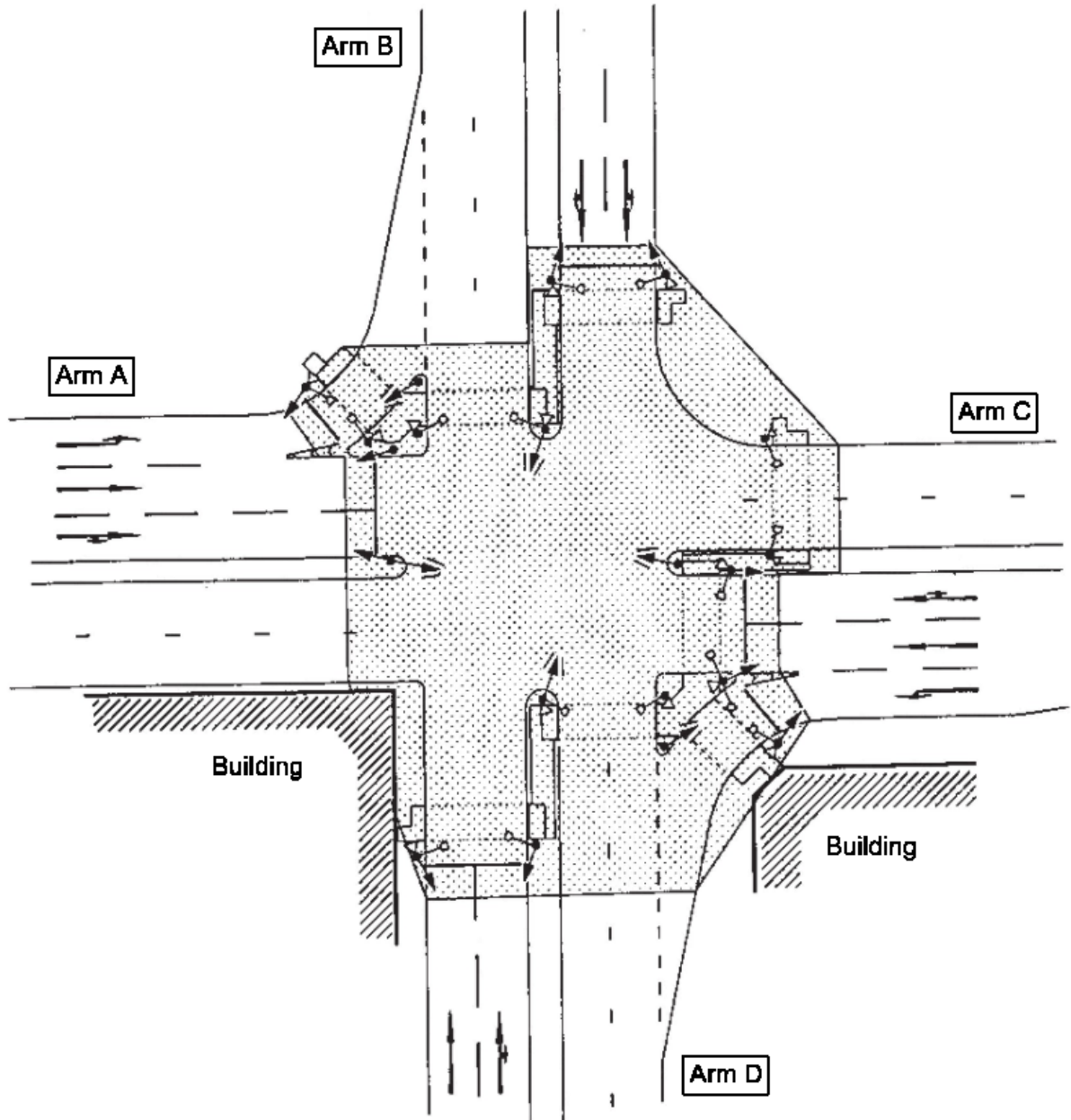

A4 Signal-controlled staggered junctions

A4.1 Operation of signal-controlled staggered junctions

A large stagger may result in the need to treat the layout as two separately signal-controlled junctions, whereas a small stagger, possibly with a banned turn, could allow the junction to be treated as a simple signal-controlled crossroad. The stagger distances will usually determine the phasing, stages and timing of the traffic signals.

Where the stagger distance is greater than 250 metres the junctions are normally be considered as two separate independent signal-controlled T-junctions.

Where the stagger distance is between 75 metres and 250 metres the junctions are normally treated as two separate, signal-controlled T-junctions with local linking of the signals to favour the major flows of traffic through the junction.

Where the stagger distance is below 75 metres the junction is normally considered a single signal-controlled staggered junction, provided there is sufficient reservoir length.

As the stagger distance reduces below 75 metres, it becomes more difficult to provide for the inner stop lines, pedestrian crossing facilities and associated signals. The shortest effective reservoir length is 15 metres. With a reservoir length below 15 metres, the junction is normally treated as a signal-controlled crossroad with special account being taken of longer clearance distances.

Staggered signal-controlled junctions with short stagger distances could suffer from junction blocking due to a limited reservoir length between the two staggered arms.

A4.2 Left/right staggers

Figure A.5 illustrates an example of an urban left/right staggered signal-controlled junction, typical of a situation where the stagger distance is less than 75 metres, the reservoir length is greater than 15 metres and the presence of large goods vehicles in significant proportions is not expected. The following design features are incorporated in the example illustrated:

- a) two lane approach and departure on all arms;
- b) circular corner radii without tapers (no provision for large goods vehicles); and
- c) inner stop lines.

A left/right stagger will usually have more onerous signal control due to the greater level of right turn traffic than a right/left stagger.

If a left/right staggered junction with less than a 75 metre stagger is signal-controlled using a 2-stage control (i.e. both the staggered arms run together), there will be a conflict as the traffic emerging from one of the arms turns right across the path of vehicles turning right into the same arm (refer to the points marked "X" in Figure A.6). This could be hazardous if there is no intervisibility approaching the conflict point. Unless these movements are very low in volume and the length of stagger is small, 3-stage signalling is normally used with separate stages for each of the staggered approaches.

Figure A.5 Example of a left/right staggered junction

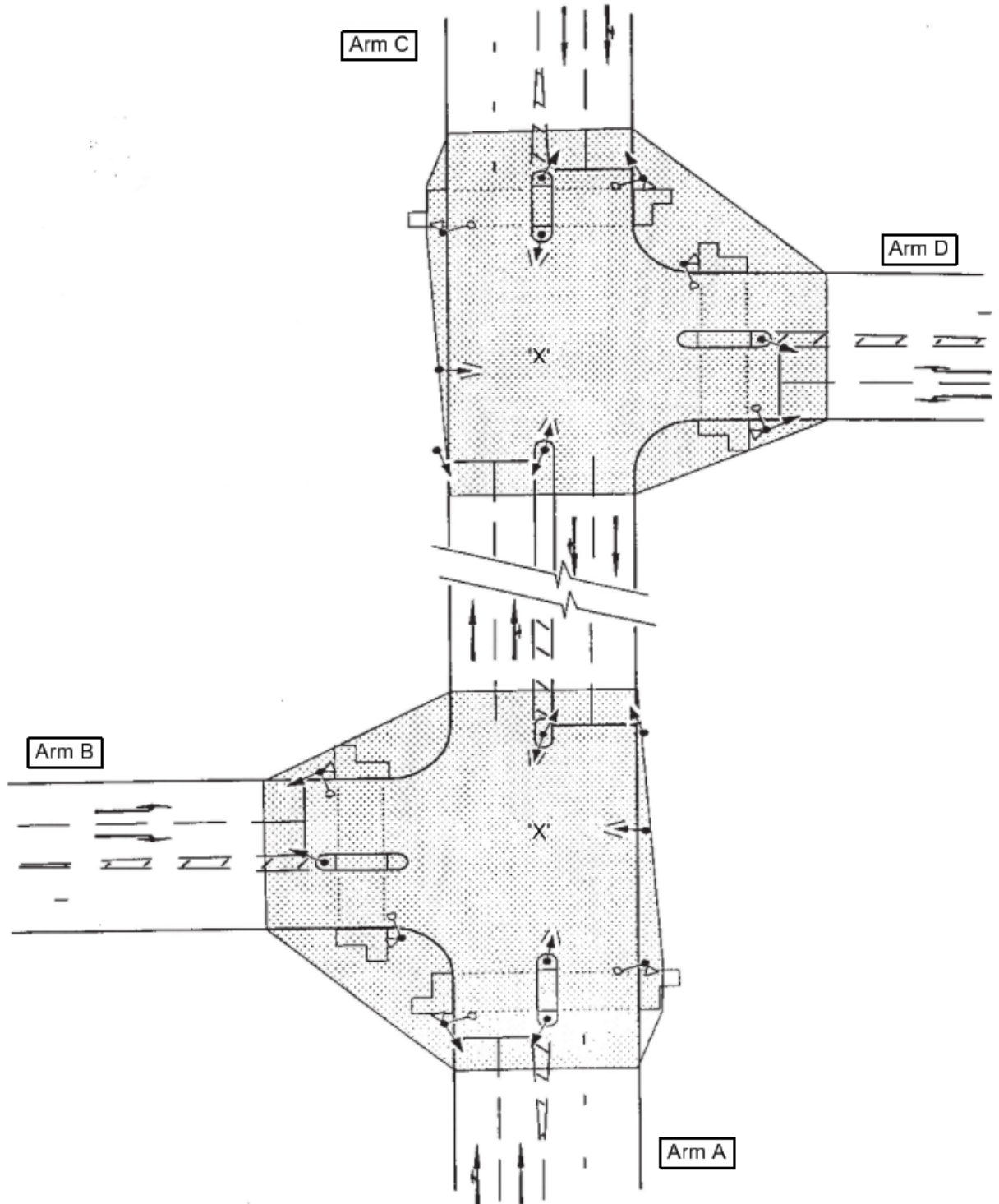

A4.3 Right/left staggers

Figure A.6 illustrates an example of an urban right/left staggered junction, typical of a situation where the stagger distance is less than 75 metres, the reservoir length is greater than 15 metres and the presence of large goods vehicles in significant proportions is not expected. The following design features are incorporated into the example illustrated:

- 1) two lane approach and departure on all arms;
- 2) circular corner radii without tapers (no provision for large goods vehicles); and
- 3) inner stop-lines.

With a stagger distance of 75 metres or greater, the inner stop-lines (marked "Y" on Figure A.6) are normally included to eliminate the very long clearance distances and extended inter-green periods which would otherwise be necessary.

Where a significant volume of pedestrian movement is anticipated, it could be beneficial to provide pedestrian facilities at each stop-line as illustrated on Arms A, C and D of the lower half of Figure A.6. Where no pedestrian desire lines exist, and the stagger distance is not great, a reduced number of pedestrian crossing facilities could be justified, as indicated on Arms B and C of the upper half of Figure A.6.

In Figure A.6, the left turn from Arm B to Arm C is prohibited.

Figure A.6 Example of a right/left staggered junction

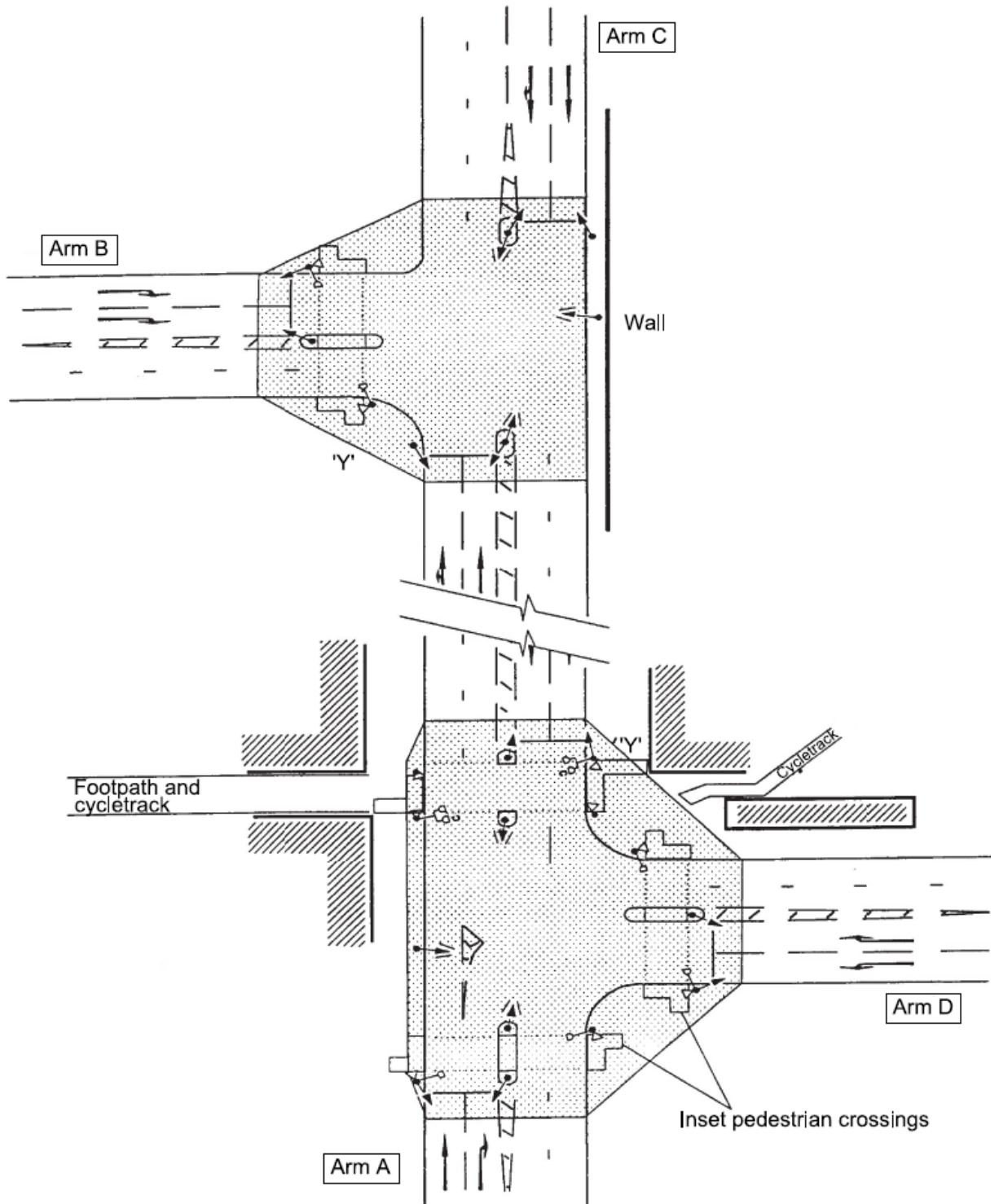

A5 Signal-controlled skew junctions

Figure A.7 illustrates an example of an existing urban signal-controlled skew junction between two single carriageways intersecting at 70 degrees, typical of a situation where available road space is restricted and the presence of large goods vehicles in significant proportions is not expected. The following specific design features are incorporated into the example:

- a) single lane approach and departure on all arms;
- b) circular corner radii without tapers (no provision for large goods vehicles);
- c) a simple left turn slip lane and priority junction (Arm D to A); and
- d) left turn movements from Arm B to C are prohibited due to the tight corner radius.

Where the roads intersect at angles other than 90 degrees, the following problems can be encountered:

- 1) priority might not be obvious to drivers;
- 2) intervisibility could be adversely effected;
- 3) the possibility of high speed turning movements on the obtuse angles of the junction;
- 4) difficulty for drivers to turn around the acute angles of the junction (particularly those of larger vehicles); and
- 5) difficulty in locating secondary signals.

Turning radii can be improved by the introduction of left turn slip lanes. It may also be beneficial to set stop-lines back by a reasonable distance to accommodate the junction corner radii, any left turn slip lanes and to assist in locating secondary signals.

In Figure A.7, the left left turn from Arm B to Arm C is prohibited.

Figure A.7 Example of a signal-controlled skew junction

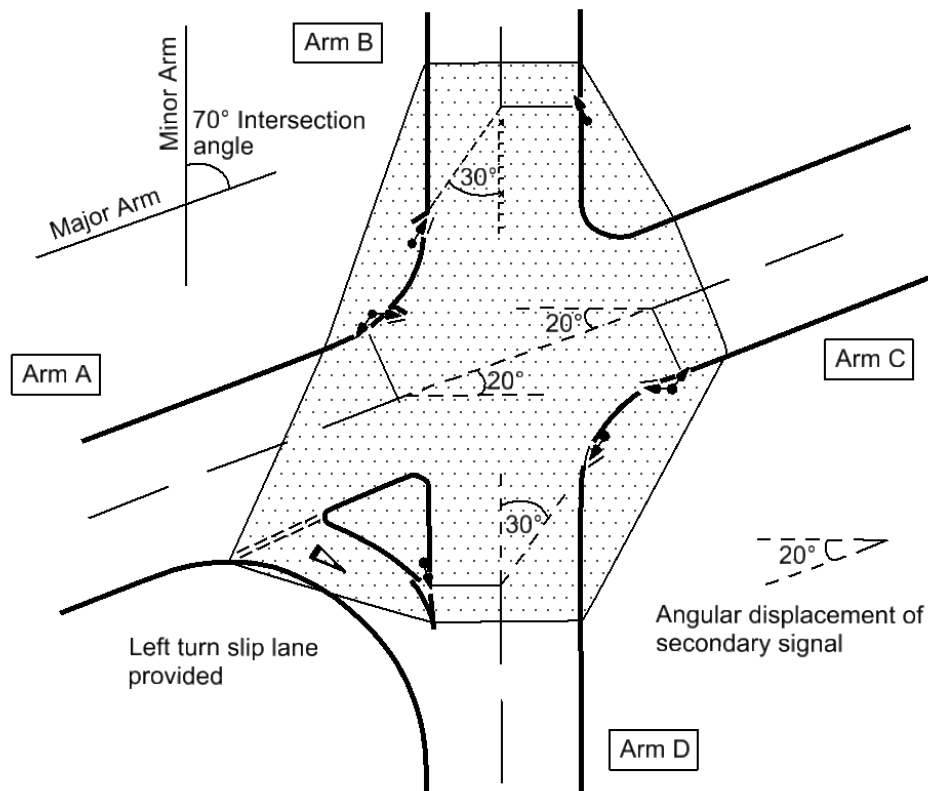

A6 Signal-controlled junctions on one-way roads

Figure A.8 illustrates an example of a signal-controlled junction between two one-way roads (Arms A and B) and a two-way road (Arm C) incorporating a traffic island and pedestrian crossing facilities.

Figure A.8 Example of a signal-controlled junction on one-way roads

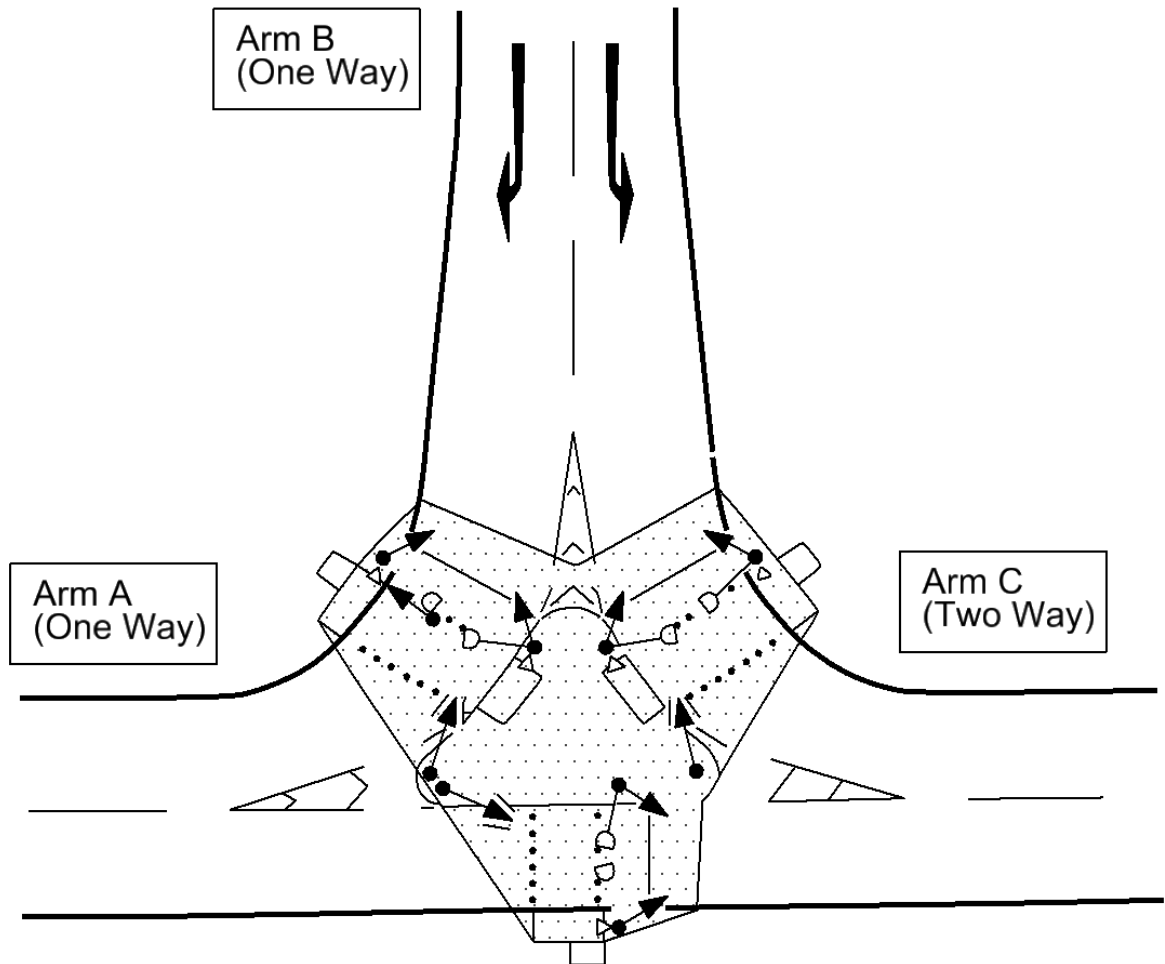

A7 Signal-controlled junctions with more than four arms

When signal-controlled junctions have more than 4 arms, efficient signalling is difficult to design. The banning of one or more right turns or directing traffic away from the junction will assist in alleviating these difficulties.

© Crown copyright 2021.

You may re-use this information (not including logos) free of charge in any format or medium, under the terms of the Open Government Licence. To view this licence:

visit www.nationalarchives.gov.uk/doc/open-government-licence/,
write to the **Information Policy Team, The National Archives, Kew, London TW9 4DU**,
or email psi@nationalarchives.gsi.gov.uk.