

- NOTES
1. THIS DRAWING SHOULD BE READ IN CONJUNCTION WITH ALL SPECIFICATIONS.
  2. ANY DISCREPANCIES SHOULD BE REPORTED TO THE ARCHITECT/ENGINEER IMMEDIATELY SO THAT CLARIFICATION CAN BE SOUGHT PRIOR TO THE COMMENCEMENT OF WORK.
  3. PRIOR TO CONSTRUCTION WORKS COMMENCING ON SITE, THE LOCATION OF ALL EXISTING SERVICES ARE TO BE CHECKED AND THEIR DEPTHS VERIFIED.
  4. DUCT PROVISIONS TO BE DETERMINED BY SERVICES DESIGNER.
  5. REFER TO BILDAID Dwg No. 1903/05/216.
  6. REFER TO TRAFFIC SPAN DRAWINGS 1903/05/05-09 FOR LOCATION OF SIGNS.

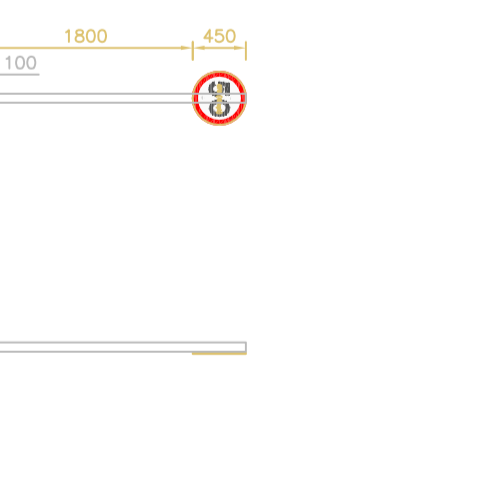
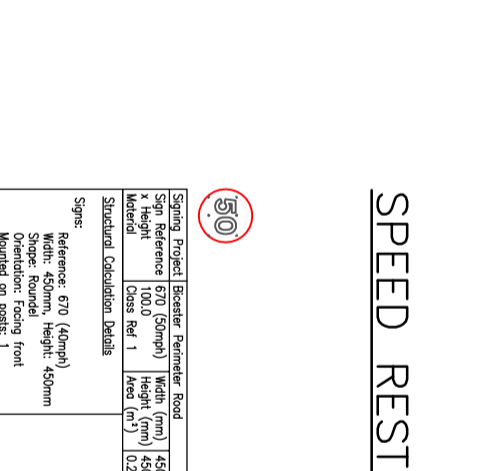
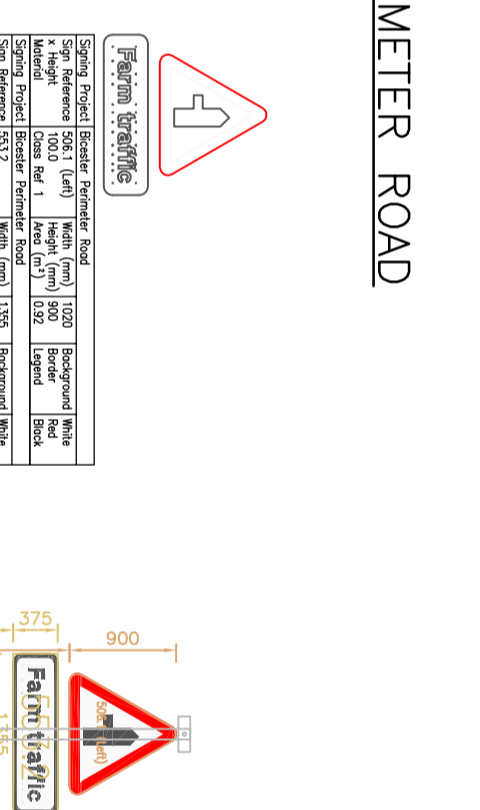
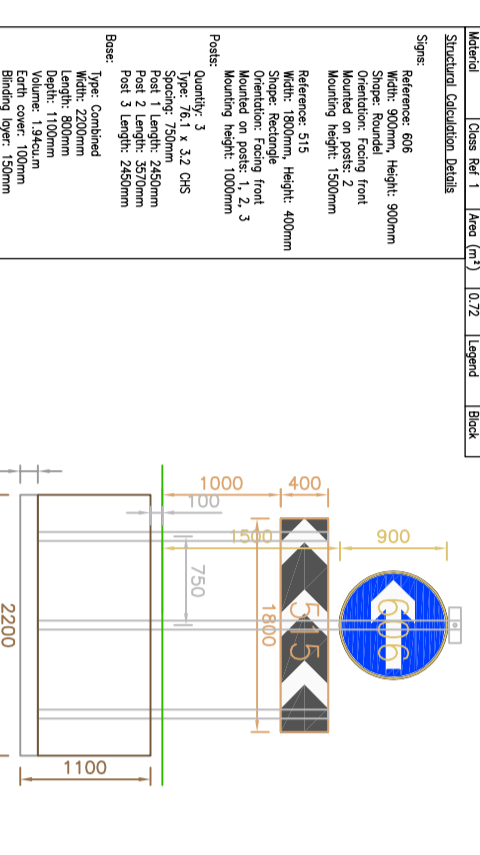
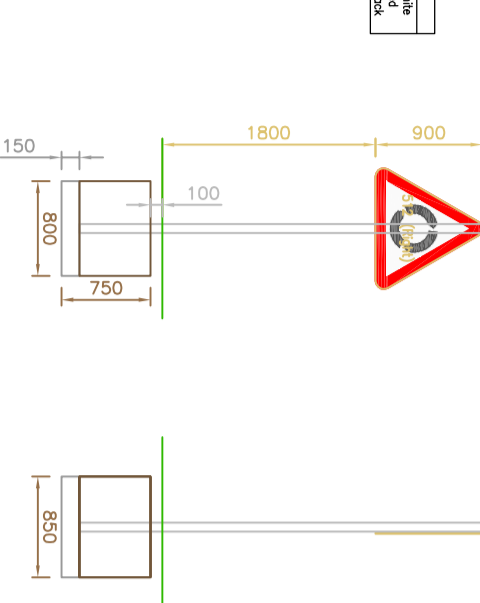
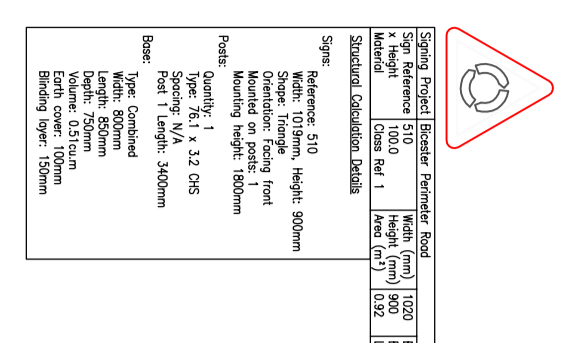
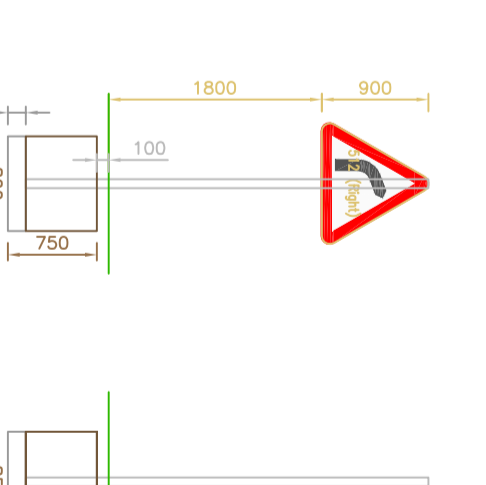
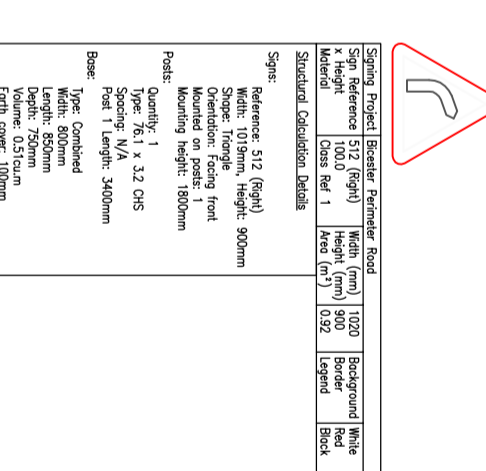
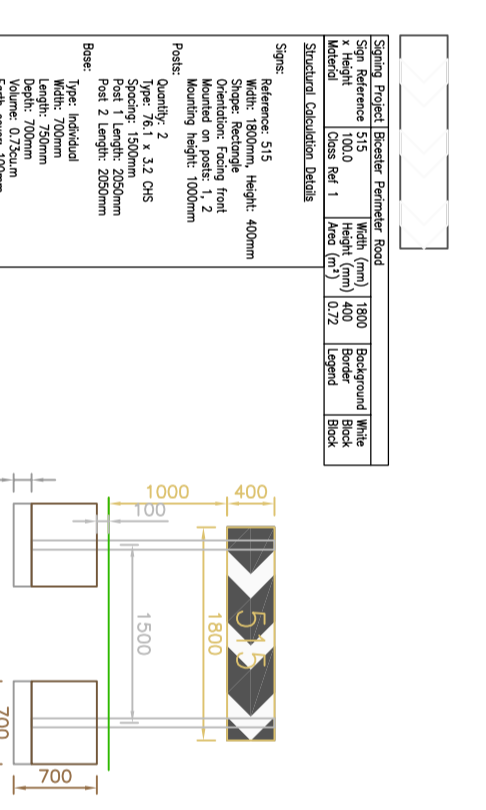
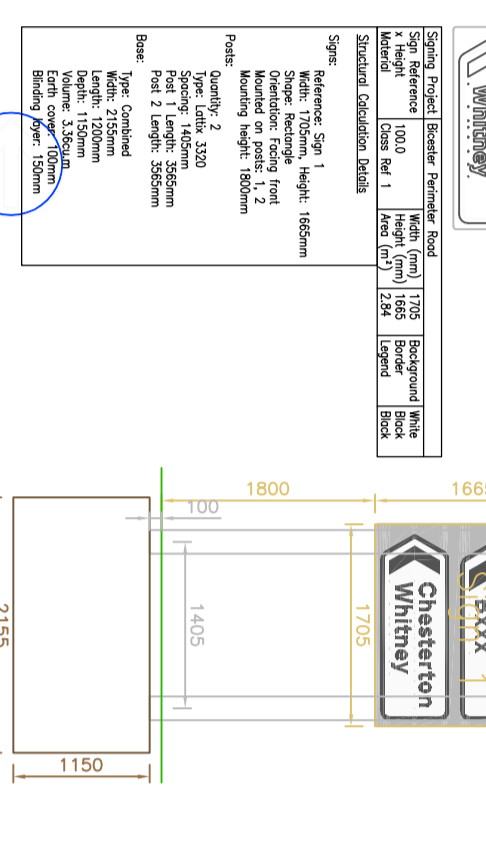
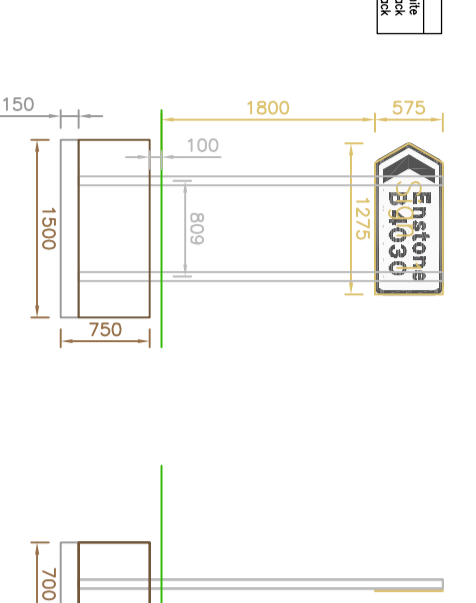
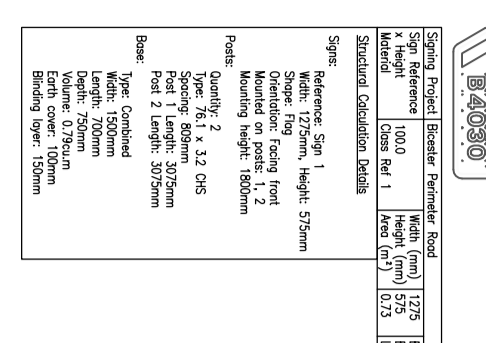
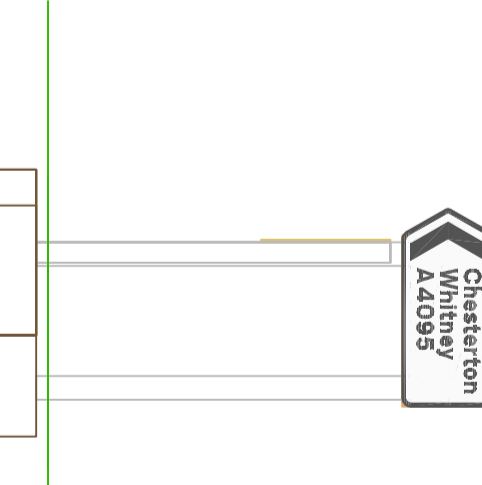
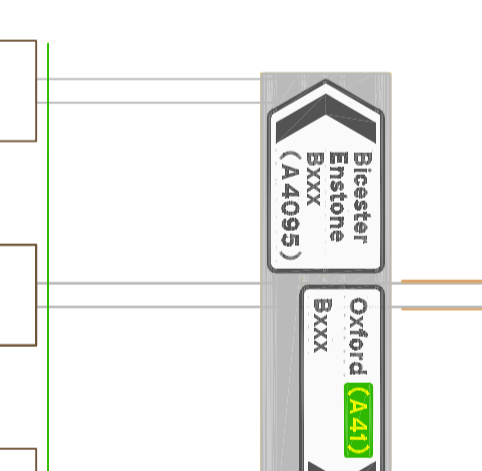
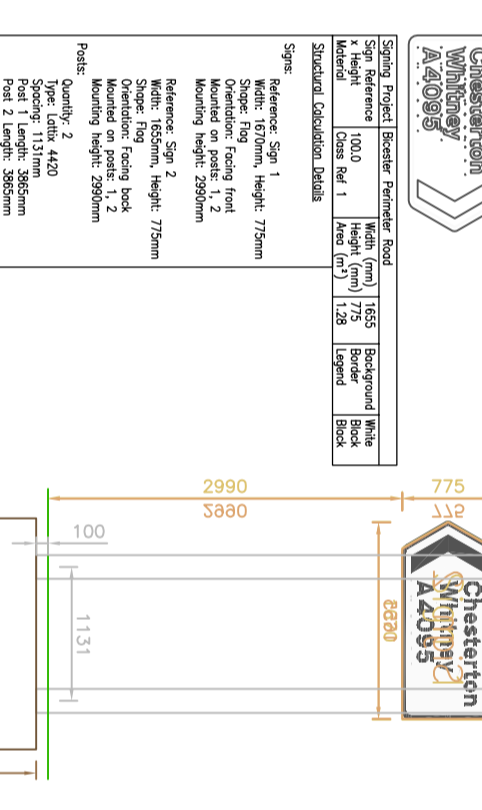
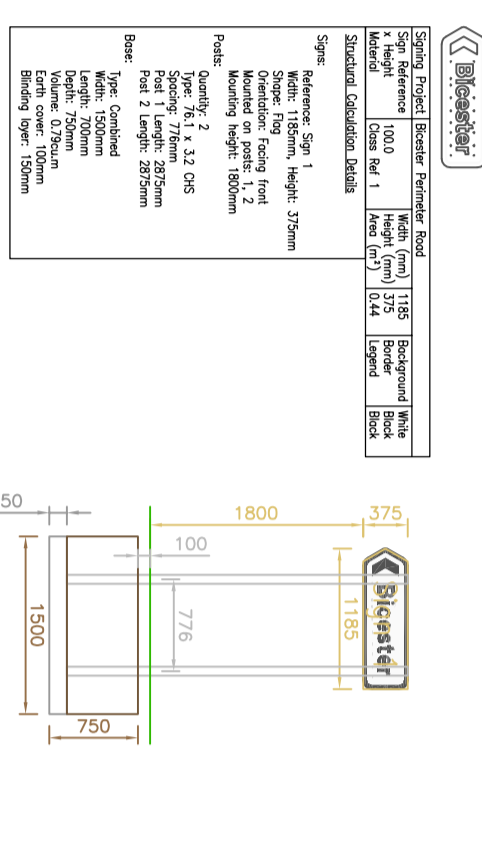
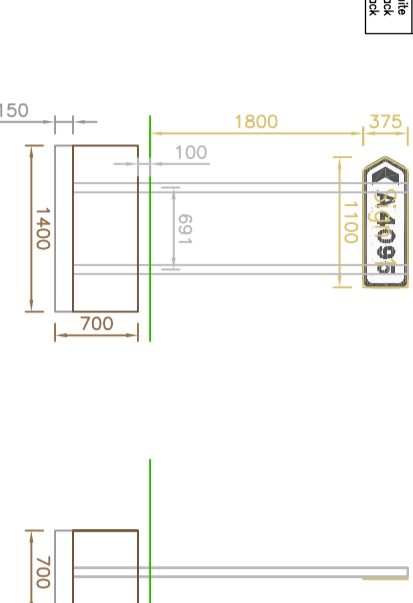
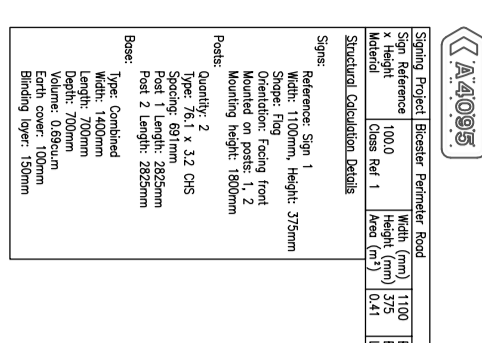
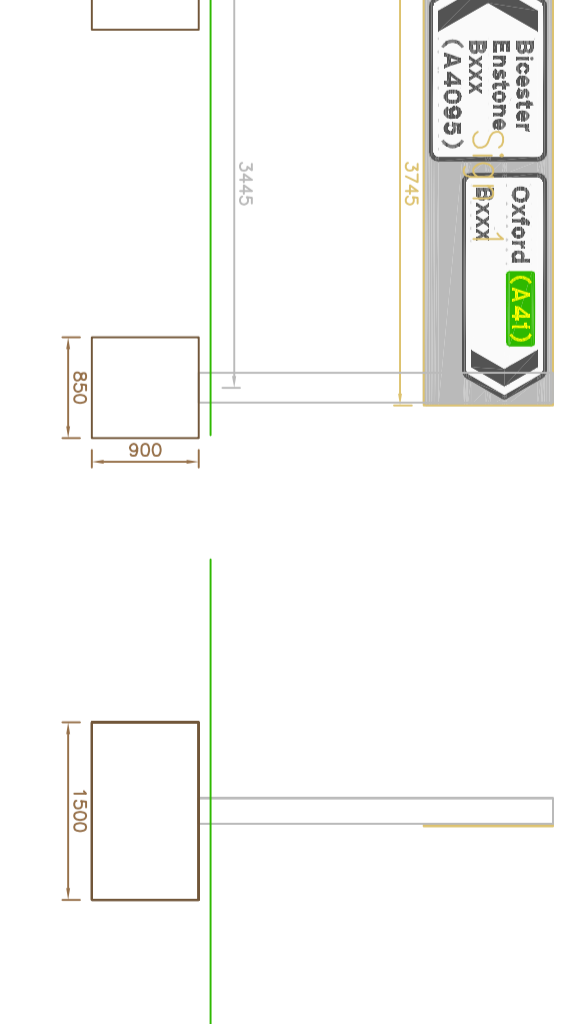
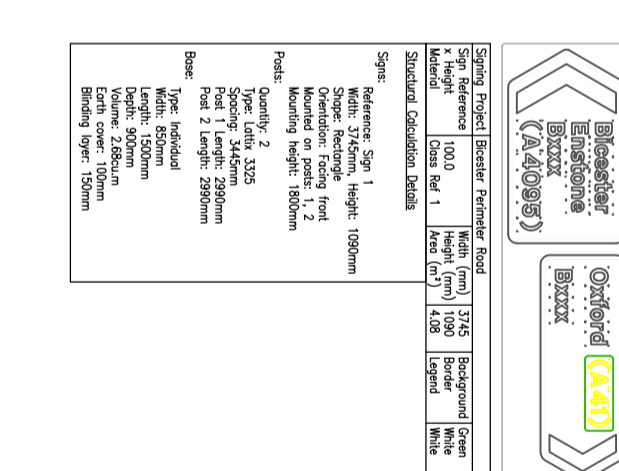
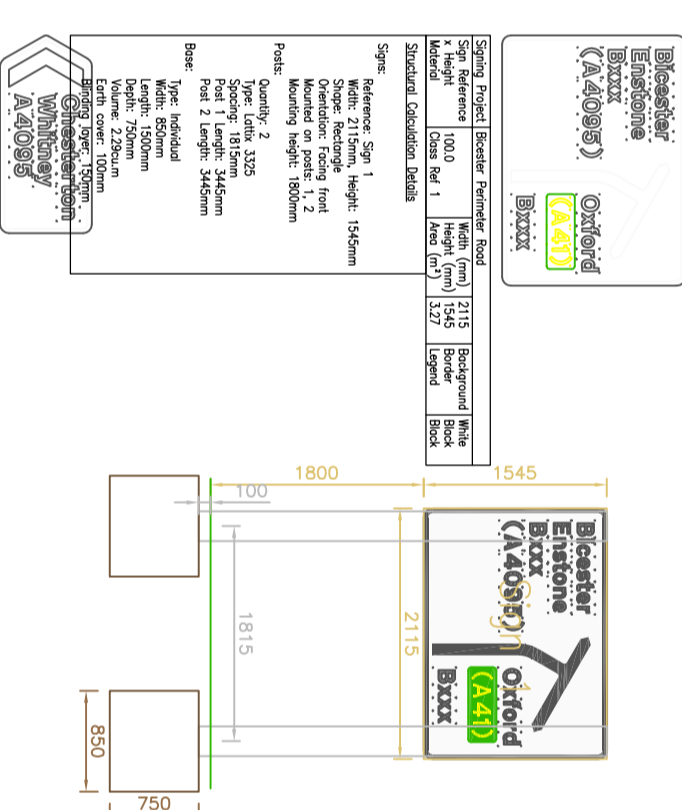
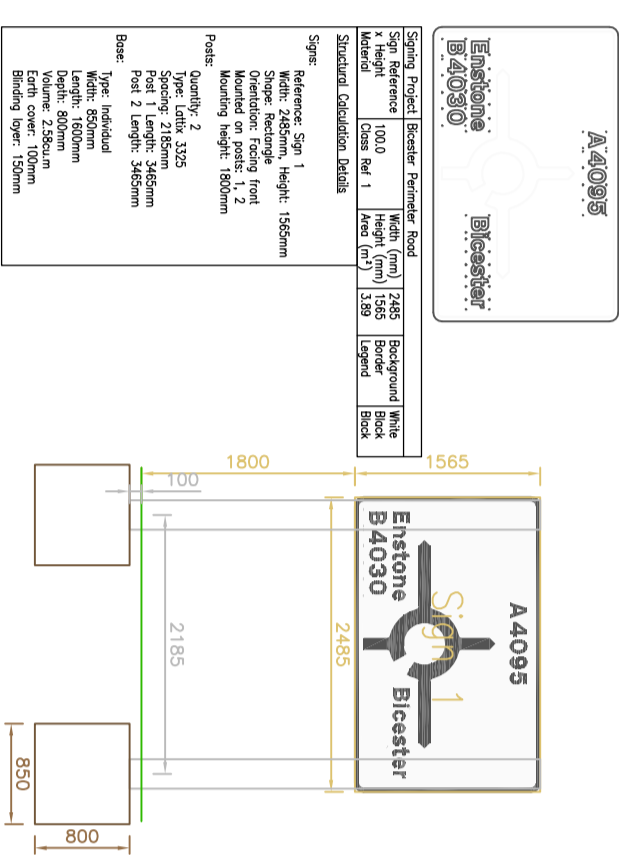
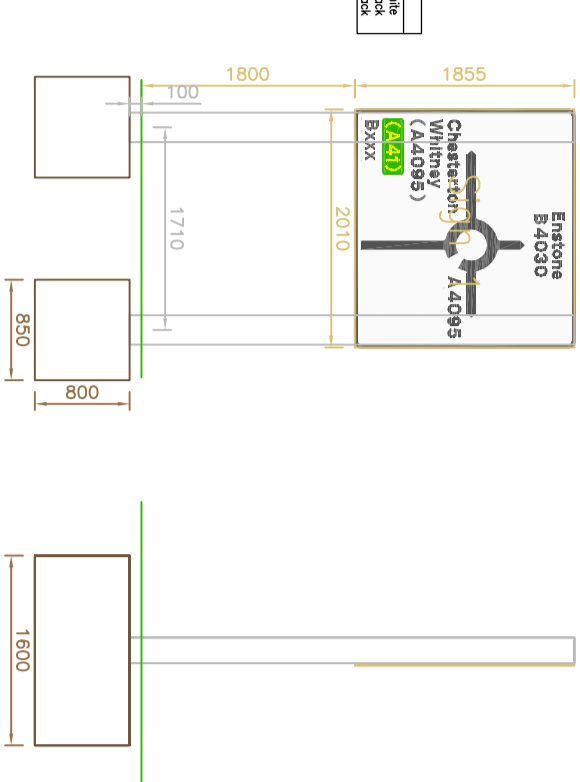
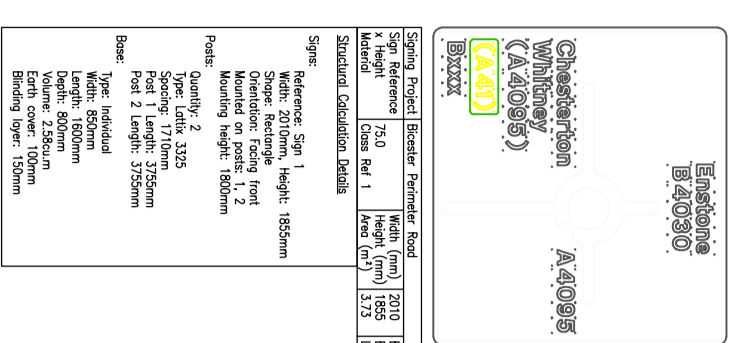

PERIMETER ROAD

SPEED RESTRICTION

CYCLEWAY

BOLLARD FACE

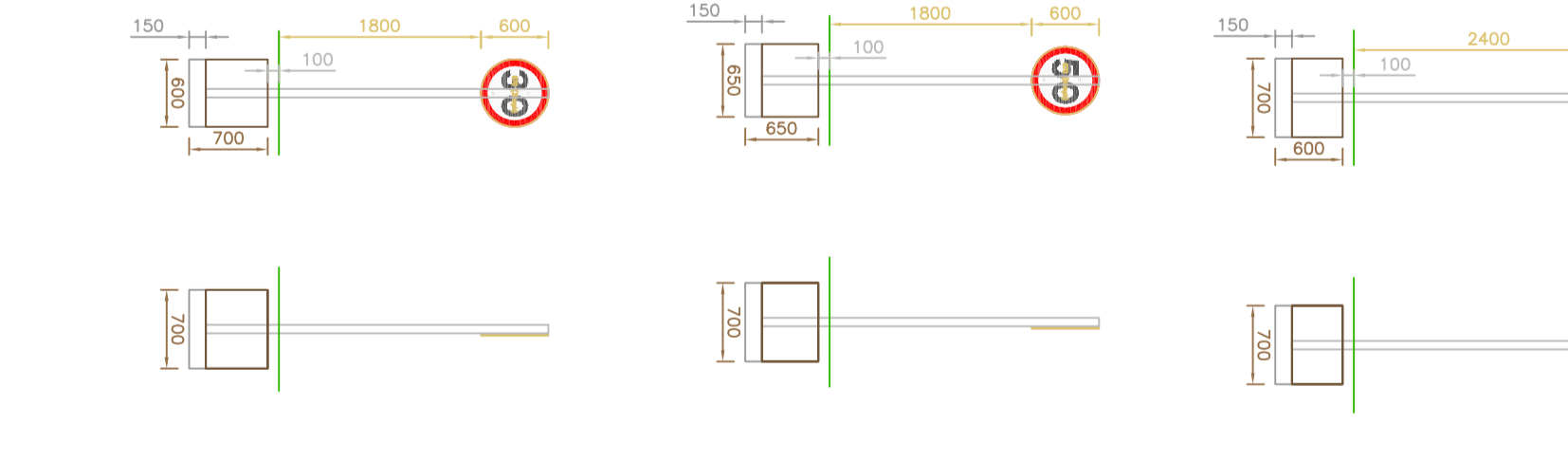
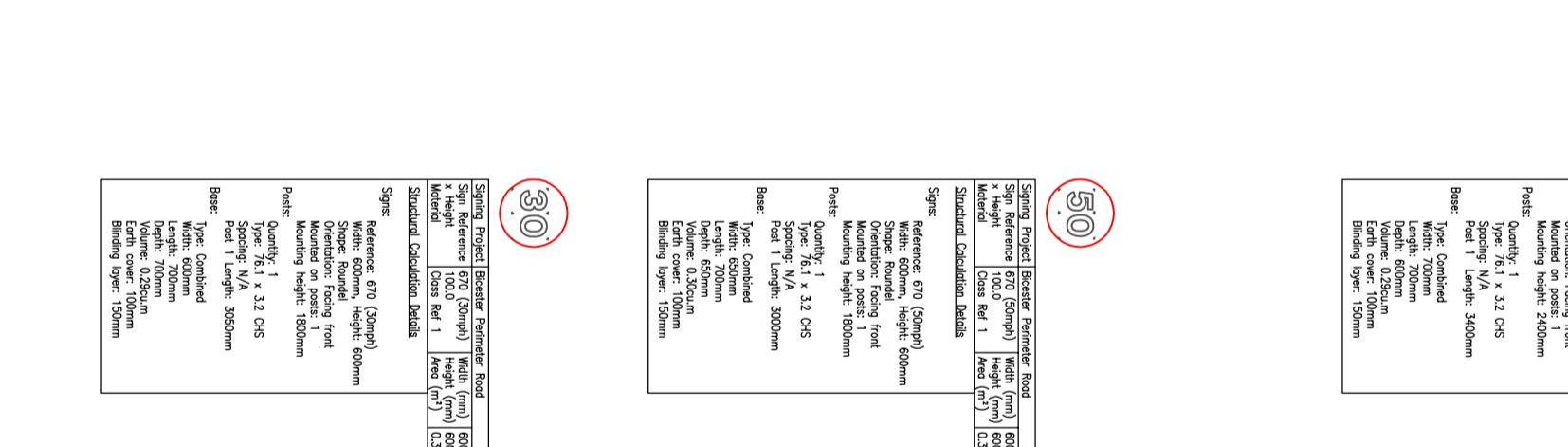
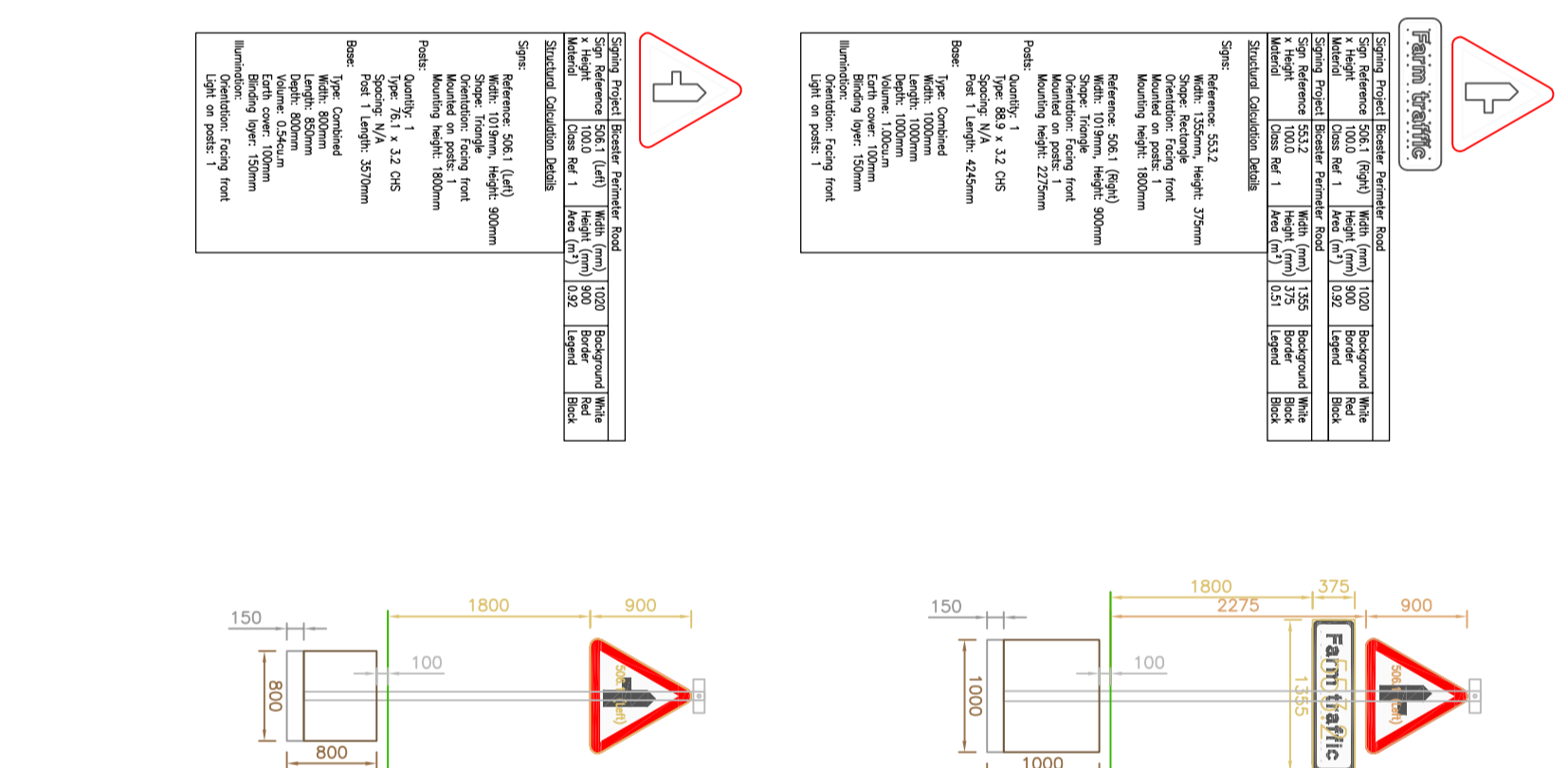
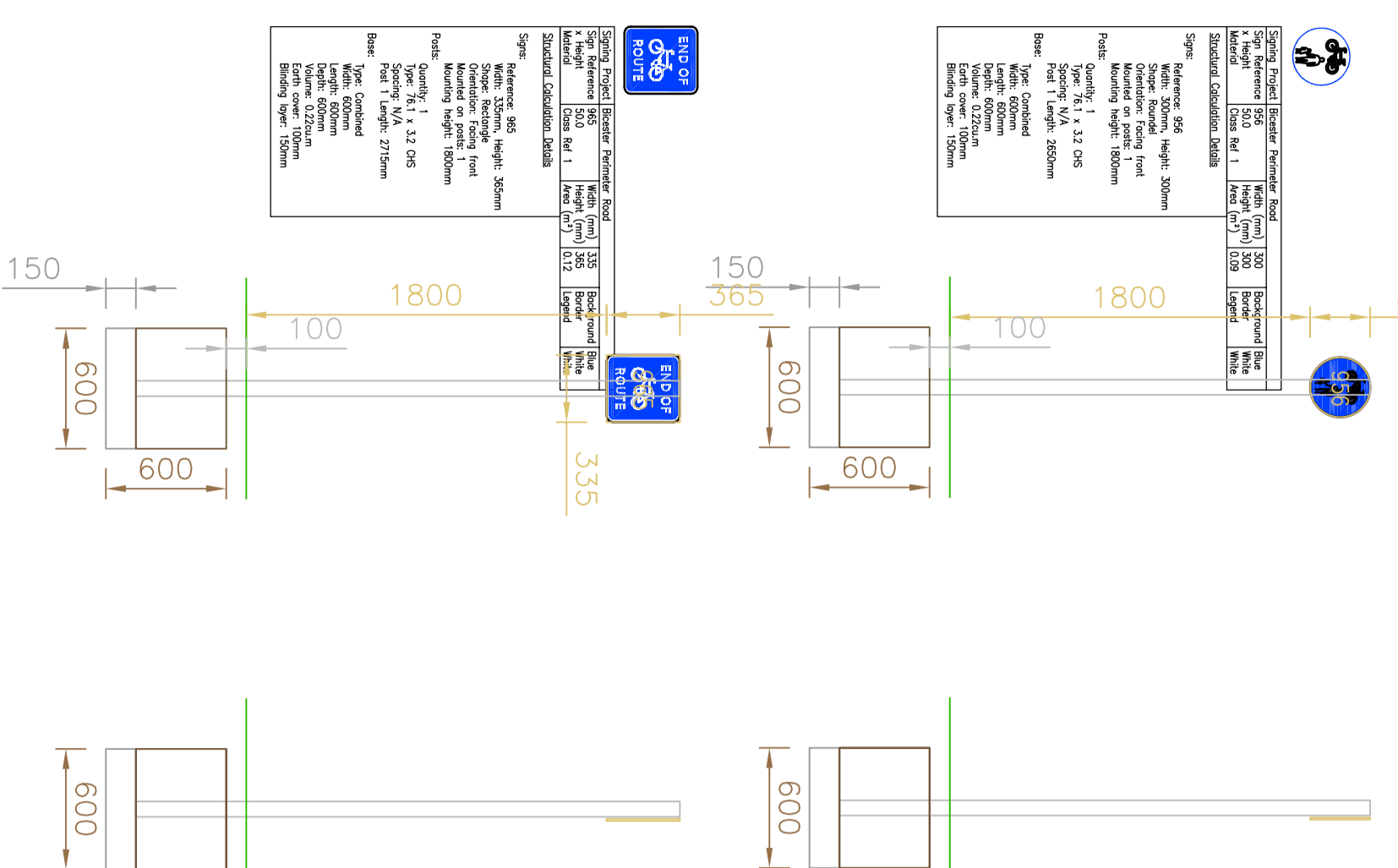

FOR INFORMATION ONLY		DATE	BY	DESCRIPTION	CHKD	APPD
1	20/03/09	BE	BE	CONSTRUCTION		
2	04/04/09	BE	BE			

Manufacturer: Hovata (Spain) / Via: Beldinghita / Valencia / RC21 / M41  
 Tel: +44 (0)1256 318800 / Fax: +44 (0)1256 318100  
 http://www.wspgroup.com

COUNTRY: SOUTH WEST BRISTOL  
 PROJECT: BRISTOL, OXFORDSHIRE

CLIENT: HONES LANE ROUNDABOUT & PERIMETER LINK ROAD SIGNAGE CONSTRUCTION DETAILS

SCALE: 1:25  
 DATE: 19/03/2010  
 DRAWN BY: JAM  
 CHECKED BY: GJH  
 PROJECT NO: 11011903  
 SHEET NO: 1903/TS/010  
 OF: A

© WSP Group plc